

# Intel® Solid-State Drive DC S3500 Series

## Product Specification

- **Capacity:**
  - 2.5-inch: 80/120/160/240/300/480/600/800 GB
  - 1.8-inch: 80/240/400/800 GB
- **Components:**
  - Intel® 20nm NAND Flash Memory
  - Multi-Level Cell (MLC)
- **Form Factor:** 2.5-inch and 1.8-inch
- **Read and Write IOPS<sup>1,2</sup> (Full LBA Range, Iometer\* Queue Depth 32)**
  - Random 4 KB<sup>3</sup> Reads: Up to 75,000 IOPS
  - Random 4 KB Writes: Up to 11,500 IOPS
  - Random 8 KB<sup>3</sup> Reads: Up to 47,500 IOPS
  - Random 8 KB Writes: Up to 5,500 IOPS
- **Bandwidth Performance<sup>1</sup>**
  - Sustained Sequential Read: Up to 500 MB/s<sup>4</sup>
  - Sustained Sequential Write: Up to 450 MB/s
- **Latency (average sequential)**
  - Read: 50 µs (TYP)
  - Write: 65 µs (TYP)
- **Quality of Service<sup>5, 6</sup>**
  - Read/Write: 500 µs / 5 ms (99.9%)
- **AES 256-bit Encryption**
- **Compliance**
  - SATA Revision 3.0; compatible with SATA 6Gb/s, 3Gb/s and 1.5Gb/s interface rates
  - ATA8-ACS2; includes SCT (Smart Command Transport) and device statistics log support
  - Enhanced SMART ATA feature set
  - Native Command Queuing (NCQ) command set
  - Data set management Trim command
- **Compatibility**
  - Windows 7 and Windows 8
  - Windows Server 2012
  - Windows Server 2008 Enterprise 32/64bit SP2
  - Windows Server 2008 R2 SP1
  - Windows Server 2003 Enterprise R2 64bit SP2
  - Red Hat Enterprise Linux\* 5.5, 5.6, 6.1, 6.3
  - SUSE\* Linux Enterprise Server 10, 11 SP1
  - CentOS 64bit 5.7, 6.3
  - Intel® SSD Toolbox with Intel® SSD Optimizer
- **Product Ecological Compliance**
  - RoHS\*
- **Power Management**
  - 2.5 inch: 5 V or 12 V SATA Supply Rail<sup>7</sup>
  - 1.8 inch: 3.3 V SATA Supply Rail
  - SATA Interface Power Management
  - OS-aware hot plug/removal
  - Enhanced power-loss data protection
- **Power**
  - Active: Up to 5.0 W (TYP)
  - Idle: 650 mW<sup>8</sup>
- **Weight:**
  - 2.5-inch 80-240 GB: 70 grams ± 2 grams
  - 2.5-inch 300-800 GB: 72 grams ± 2 grams
  - 1.8-inch 80 GB: 35 grams ± 2 grams
  - 1.8-inch 240-800 GB: 37 grams ± 2 grams
- **Temperature**
  - Operating: 0° C to 70° C
  - Non-Operating<sup>9</sup>: -55° C to 95° C
  - Temperature monitoring and logging
  - Thermal throttling
- **Shock (operating and non-operating):**
  - 1,000 G/0.5 msec
- **Vibration**
  - Operating: 2.17 G<sub>RMS</sub> (5-700 Hz)
  - Non-Operating: 3.13 G<sub>RMS</sub> (5-800 Hz)
- **Altitude (simulated)**
  - Operating: -1,000 to 10,000ft
  - Non-Operating: -1,000 to 40,000ft
- **Reliability**
  - Uncorrectable Bit Error Rate (UBER):
    - 1 sector per 10<sup>17</sup> bits read
  - Mean Time Between Failures (MTBF):
    - 2,000,000 hours
  - End-to-End data protection
- **Endurance Rating<sup>10</sup>:**
  - 80 GB: 45 TBW
  - 120 GB: 70 TBW
  - 160 GB: 100 TBW
  - 240 GB: 140 TBW
  - 300 GB: 170 TBW
  - 400 GB: 225 TBW
  - 480 GB: 275 TBW
  - 600 GB: 330 TBW
  - 800 GB: 450 TBW
- **Certifications and Declarations**
  - UL\*, CE\*, C-Tick\*, BSMI\*, KCC\*, Microsoft\* WHCK, VCCI\*, SATA-IO

1. Performance values vary by capacity and form factor

2. Performance specifications apply to both compressible and incompressible data

3. 4 KB = 4,096 bytes; 8 KB = 8,192 bytes

4. MB/s = 1,000,000 bytes/second.

5. Based on Random 4KB QD=1 workload, measured as the time taken for 99.9 percentile of commands to finish the round-trip from host to drive and back to host

6. Measurement taken once the workload has reached steady state but including all background activities required for normal operation and data reliability

7. Defaults to 12V, if both 12V and 5V are present

8. Based on 5V supply

9. Please contact your Intel representative for details on the non-operating temperature range

10. Based on JESD218 standard



## Ordering Information

Contact your local Intel sales representative for ordering information.

INFORMATION IN THIS DOCUMENT IS PROVIDED IN CONNECTION WITH INTEL PRODUCTS. NO LICENSE, EXPRESS OR IMPLIED, BY ESTOPPEL OR OTHERWISE, TO ANY INTELLECTUAL PROPERTY RIGHTS IS GRANTED BY THIS DOCUMENT. EXCEPT AS PROVIDED IN INTEL'S TERMS AND CONDITIONS OF SALE FOR SUCH PRODUCTS, INTEL ASSUMES NO LIABILITY WHATSOEVER AND INTEL DISCLAIMS ANY EXPRESS OR IMPLIED WARRANTY, RELATING TO SALE AND/OR USE OF INTEL PRODUCTS INCLUDING LIABILITY OR WARRANTIES RELATING TO FITNESS FOR A PARTICULAR PURPOSE, MERCHANTABILITY, OR INFRINGEMENT OF ANY PATENT, COPYRIGHT OR OTHER INTELLECTUAL PROPERTY RIGHT.

A "Mission Critical Application" is any application in which failure of the Intel Product could result, directly or indirectly, in personal injury or death. SHOULD YOU PURCHASE OR USE INTEL'S PRODUCTS FOR ANY SUCH MISSION CRITICAL APPLICATION, YOU SHALL INDEMNIFY AND HOLD INTEL AND ITS SUBSIDIARIES, SUBCONTRACTORS AND AFFILIATES, AND THE DIRECTORS, OFFICERS, AND EMPLOYEES OF EACH, HARMLESS AGAINST ALL CLAIMS COSTS, DAMAGES, AND EXPENSES AND REASONABLE ATTORNEYS' FEES ARISING OUT OF, DIRECTLY OR INDIRECTLY, ANY CLAIM OF PRODUCT LIABILITY, PERSONAL INJURY, OR DEATH ARISING IN ANY WAY OUT OF SUCH MISSION CRITICAL APPLICATION, WHETHER OR NOT INTEL OR ITS SUBCONTRACTOR WAS NEGLIGENT IN THE DESIGN, MANUFACTURE, OR WARNING OF THE INTEL PRODUCT OR ANY OF ITS PARTS.

Intel may make changes to specifications and product descriptions at any time, without notice. Designers must not rely on the absence or characteristics of any features or instructions marked "reserved" or "undefined." Intel reserves these for future definition and shall have no responsibility whatsoever for conflicts or incompatibilities arising from future changes to them. The information here is subject to change without notice. Do not finalize a design with this information.

The products described in this document may contain design defects or errors known as errata which may cause the product to deviate from published specifications. Current characterized errata are available on request.

Contact your local Intel sales office or your distributor to obtain the latest specifications and before placing your product order.

Copies of documents which have an order number and are referenced in this document, or other Intel literature, may be obtained by calling 1-800-548-4725, or go to: <http://www.intel.com/design/literature.htm>

Low Halogen applies only to brominated and chlorinated flame retardants (BFRs/CFRs) and PVC in the final product. Intel components as well as purchased components on the finished assembly meet JS-709 requirements, and the PCB/substrate meet IEC 61249-2-21 requirements. The replacement of halogenated flame retardants and/or PVC may not be better for the environment.

Intel and the Intel logo are trademarks of Intel Corporation in the U.S. and other countries.

\*Other names and brands may be claimed as the property of others.

Copyright © 2013 Intel Corporation. All rights reserved.



## Contents

---

<b>Revision History</b> .....	<b>4</b>
<b>Terms and Acronyms</b> .....	<b>4</b>
<b>1.0 Overview</b> .....	<b>5</b>
<b>2.0 Product Specifications</b> .....	<b>6</b>
2.1 Capacity .....	6
2.2 Performance .....	6
2.3 Electrical Characteristics .....	8
2.4 Environmental Conditions .....	10
2.5 Product Regulatory Compliance .....	11
2.6 Reliability .....	11
2.7 Temperature Sensor .....	12
2.8 Power Loss Capacitor Test .....	12
2.9 Hot Plug Support .....	12
<b>3.0 Mechanical Information</b> .....	<b>13</b>
<b>4.0 Pin and Signal Descriptions</b> .....	<b>15</b>
4.1 2.5-inch Form Factor Pin Locations .....	15
4.2 1.8-inch Form Factor Pin Locations .....	15
4.3 Connector Pin Signal Definitions .....	16
4.4 Power Pin Signal Definitions .....	16
<b>5.0 Supported Command Sets</b> .....	<b>18</b>
5.1 ATA General Feature Command Set .....	18
5.2 Power Management Command Set .....	18
5.3 Security Mode Feature Set .....	18
5.4 SMART Command Set .....	19
5.5 Device Statistics .....	24
5.6 SMART Command Transport (SCT) .....	25
5.7 Data Set Management Command Set .....	25
5.8 Host Protected Area Command Set .....	25
5.9 48-Bit Address Command Set .....	25
5.10 General Purpose Log Command Set .....	25
5.11 Native Command Queuing .....	26
5.12 Software Settings Preservation .....	26
<b>6.0 Certifications and Declarations</b> .....	<b>27</b>
<b>7.0 References</b> .....	<b>27</b>
<b>Appendix A: IDENTIFY DEVICE Command Data</b> .....	<b>28</b>



## Revision History

Date	Revision	Description
April 2013	001	Initial release.

## Terms and Acronyms

Term	Definition
ATA	Advanced Technology Attachment
CRC	Cyclic Redundancy Check
DAS	Device Activity Signal
DMA	Direct Memory Access
ECC	Error Correction Code
EXT	Extended
FPDMA	First Party Direct Memory Access
GB	Gigabyte Note: The total usable capacity of the SSD may be less than the total physical capacity because a small portion of the capacity is used for NAND flash management and maintenance purposes.
Gb	Gigabit
HDD	Hard Disk Drive
HET	High Endurance Technology
KB	Kilobyte
I/O	Input/Output
IOPS	Input/Output Operations Per Second
ISO	International Standards Organization
LBA	Logical Block Address
MB	Megabyte (1,000,000 bytes)
MLC	Multi-level Cell
MTBF	Mean Time Between Failures
NCQ	Native Command Queuing
NOP	No Operation
PB	Petabyte
PCB	Printed Circuit Board
PIO	Programmed Input/Output
RDT	Reliability Demonstration Test
RMS	Root Mean Square
SATA	Serial Advanced Technology Attachment
SCT	SMART Command Transport
SMART	Self-Monitoring, Analysis and Reporting Technology An open standard for developing hard drives and software systems that automatically monitors the health of a drive and reports potential problems.
SSD	Solid-State Drive
TB	Terabyte
TYP	Typical
UBER	Uncorrectable Bit Error Rate



## 1.0 Overview

This document describes the specifications and capabilities of the Intel® SSD DC S3500.

The Intel® SSD DC S3500 delivers leading performance and Quality of Service combined with world-class reliability for Serial Advanced Technology Attachment (SATA)-based computers in nine capacities: 80 GB, 120 GB, 160 GB, 240 GB, 300 GB, 400 GB, 480 GB, 600 GB and 800 GB.

By combining 20nm Intel® NAND Flash Memory technology with SATA 6Gb/s interface support, the Intel® SSD DC S3500 delivers sequential read speeds of up to 500 MB/s and sequential write speeds of up to 450 MB/s. Intel SSD DC S3500 delivers Quality of Service of 500 us for random 4KB reads measured at a queue depth of 1.

The industry-standard 2.5-inch and 1.8-inch form factors enable interchangeability with existing hard disk drives (HDDs) and native SATA HDD drop-in replacement with the enhanced performance, reliability, ruggedness, and power savings offered by an SSD.

Intel SSD DC S3500 offers these key features:

- Standard Endurance Technology
- High I/O and throughput performance
- Consistent I/O latency
- Enhanced power-loss data protection
- End-to-End data protection
- Thermal throttling
- Temperature Sensor
- Inrush current management
- Low power
- High reliability
- Enhanced ruggedness
- Temperature monitor and logging
- Power loss protection capacitor self-test



## 2.0 Product Specifications

### 2.1 Capacity

Table 1. User Addressable Sectors

Intel SSD DC S3500	Unformatted Capacity (Total User Addressable Sectors in LBA Mode)
80 GB	156,301,488
120 GB	234,441,648
160 GB	312,581,808
240 GB	468,862,128
300 GB	586,072,368
400 GB	781,422,768
480 GB	937,703,088
600 GB	1,172,123,568
800 GB	1,562,824,368

**Notes:** 1 GB = 1,000,000,000 bytes; 1 sector = 512 bytes.

LBA count shown represents total user storage capacity and will remain the same throughout the life of the drive.

The total usable capacity of the SSD may be less than the total physical capacity because a small portion of the capacity is used for NAND flash management and maintenance purposes.

### 2.2 Performance

Table 2. Random Read/Write Input/Output Operations Per Second (IOPS)

Specification <sup>1</sup>	Unit	Intel SSD DC S3500							
		80 GB (2.5"/ 1.8")	120 GB	160 GB	240 GB (2.5"/ 1.8")	300 GB	400 GB (1.8")	480 /600 GB	800 GB (2.5"/ 1.8")
Random 4 KB Read (up to) <sup>2</sup>	IOPS	70,000	75,000	75,000	75,000	75,000	75,000	75,000	75,000
Random 4 KB Write (up to)	IOPS	7,000	4,600	7,500	7,500	9,000	11,000	11,000	11,500
Random 8 KB Read (up to) <sup>3</sup>	IOPS	39,000	47,000	47,500	47,500	47,500	47,500	47,500	47,500
Random 8 KB Write (up to)	IOPS	3,700	2,300	3,800	3,800	4,400	5,500	5,500	5,500

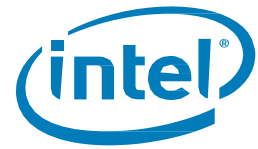

**Table 3. Random Read/Write IOPS Consistency**

Specification <sup>4</sup>	Unit	Intel SSD DC S3500							
		80GB (2.5"/1.8")	120GB	160GB	240GB (2.5"/1.8")	300GB	400GB (1.8")	480 / 600 GB	800GB (2.5"/1.8")
Random 4 KB Read (up to) <sup>2</sup>	%	90	90	90	90	90	90	90	90
Random 4 KB Write (up to)	%	75	75	75	75	75	75	75	75
Random 8 KB Read (up to) <sup>3</sup>	%	90	90	90	90	90	90	90	90
Random 8 KB Write (up to)	%	75	75	75	75	75	75	75	75

**Notes:**

1. Performance measured using Iometer\* with Queue Depth 32. Measurements are performed on a full Logical Block Address (LBA) span of the drive.
2. 4 KB = 4,096 bytes
3. 8 KB = 8,192 bytes
4. Performance consistency measured using Iometer\* based on Random 4KB QD=32 workload, measured as the (IOPS in the 99.9th percentile slowest 1-second interval)/(average IOPS during the test). Measurements are performed on a full Logical Block Address (LBA) span of the drive once the workload has reached steady state, including all background activities required for normal operation and data reliability

**Table 4. Sequential Read and Write Bandwidth**

Specification	Unit	Intel SSD DC S3500							
		80GB (2.5"/1.8")	120GB	160GB	240GB (2.5"/1.8")	300GB	400GB (1.8")	480 / 600 GB	800GB (2.5"/1.8")
Sequential Read (SATA 6Gb/s) <sup>1</sup>	MB/s	340	445	475	500	500	500	500	500
Sequential Write (SATA 6Gb/s) <sup>1</sup>	MB/s	100	135	175	260	315	380	410	450

**Notes:** 1. Performance measured using Iometer\* with 128 KB (131,072 bytes) of transfer size with Queue Depth 32.

**Table 5. Latency**

Specification	Intel SSD DC S3500	
	80GB (2.5"/1.8"), 120GB, 160GB, 240GB (2.5"/1.8"), 300GB, 400GB (1.8"), 480GB, 600 GB	800GB (2.5"/1.8")
Latency <sup>1</sup> (TYP)		
Read	50 µs	50 µs
Write	65 µs	65 µs
Power On to Ready <sup>2</sup>	2.0 s	3.0 s



**Table 6. Quality of Service**

Specification	Unit	Intel SSD DC S3500			
		Queue Depth=1		Queue Depth=32	
		80/120/160/ 240 GB	300/400/480/ 600/800 GB	80/120/160/ 240 GB	300/400/480/ 600/800 GB
<b>Quality of Service<sup>3, 4</sup> (99.9%)</b>					
Reads	ms	0.5	0.5	2	2
Writes	ms	5	2	20	10
<b>Quality of Service<sup>3,4</sup> (99.9999%)</b>					
Reads	ms	10	5	10	5
Writes	ms	10	10	30	30

**Notes:**

1. Device measured using Iometer. Latency measured using 4 KB (4,096 bytes) transfer size with Queue Depth equal to 1 on a sequential workload.
2. Power On To Ready time assumes proper shutdown. Time varies if shutdown is not preceded by STANDBY IMMEDIATE command.
3. Device measured using Iometer. Quality of Service measured using 4 KB (4,096 bytes) transfer size on a random workload on a full Logical Block Address (LBA) span of the drive once the workload has reached steady state but including all background activities required for normal operation and data reliability.
4. Based on Random 4KB QD=1, 32 workloads, measured as the time taken for 99.9(or 99.9999) percentile of commands to finish the round-trip from host to drive and back to host.

## 2.3 Electrical Characteristics

**Table 7. Operating Voltage for 2.5-inch Form Factor**

Electrical Characteristics	Intel SSSDC S3500	
	80 GB, 120 GB, 160 GB, 240 GB, 300 GB, 480 GB, 600 GB, 800 GB	
<b>5 V Operating Characteristics:</b>		
Operating Voltage range	5 V (±5%)	
Rise time (Max/Min)	1 s / 1 ms	
Fall time (Min)	1 ms	
Noise level	500 mV pp 10 Hz – 100 KHz 50 mV pp 100 KHz – 20 MHz	
Min Off time	500 ms	
Inrush Current (Typical Peak) <sup>1</sup>	1.0 A, < 1 s	
<b>12 V Operating Characteristics:</b>		
Operating Voltage range	12 V (±10%)	
Rise time (Max/Min)	1 s / 1 ms	
Fall time (Min)	1 ms	
Noise level	1000 mV pp 10 Hz – 100 KHz 100 mV pp 100 KHz – 20 MHz	
Min Off time	500 ms	
Inrush Current (Typical Peak) <sup>1</sup>	1.0 A, < 1 s	

**Notes:**

1. Measured from initial device power supply application.



**Table 8. Power Consumption for 2.5-inch Form Factor (5V Supply)**

Specification	Unit	Intel SSD DC S3500							
		80 GB	120 GB	160 GB	240 GB	300 GB	480 GB	600 GB	800 GB
Active Write - RMS Average <sup>1</sup>	W	1.8	2.0	2.3	2.9	3.5	4.3	4.5	5.0
Active Write - RMS Burst <sup>2</sup>	W	2.0	2.4	2.7	3.2	3.9	5.2	5.5	7.3
Idle	W	0.6	0.6	0.6	0.6	0.6	0.6	0.6	0.6

**Table 9. Power Consumption for 2.5-inch Form Factor (12V Supply)**

Specification <sup>1</sup>	Unit	Intel SSD DC S3500							
		80 GB	120 GB	160 GB	240 GB	300 GB	480 GB	600 GB	800 GB
Active Write - RMS Average	W	2.0	2.3	2.5	3.1	3.5	4.3	4.5	5.0
Active Write - RMS Burst	W	2.2	2.5	2.8	3.4	4.2	5.5	6.8	7.8
Idle	W	0.8	0.8	0.9	0.9	0.9	0.9	0.9	0.9

**Notes:**

1. The workload equates 128 KB (131,072 bytes) Queue Depth equal to 32 sequential writes. Root Mean Squared (RMS) average power is measured using scope trigger over a 100 ms sample period.
2. The workload equates 128 KB (131,072 bytes) Queue Depth equal to 32 sequential writes. Root Mean Squared (RMS) burst power is measured using scope trigger over a 500 us sample period.

**Table 10. Operating Voltage and Power Consumption for 1.8-inch Form Factor**

Electrical Characteristics	Intel SSD DC S3500			
	80 GB	240 GB	400 GB	800 GB
Operating Voltage for 3.3 V (±5%)				
Min	3.13 V			
Max	3.47 V			
Rise time (Max/Min)	1 s / 1 ms			
Fall time (Min)	1 ms			
Noise level	300 mV pp 10 Hz – 100 KHz 500 mV pp 100 KHz – 20 MHz			
Min Off time	500 ms			
Inrush Current (Typical Peak) <sup>1</sup>	1.2 A, < 1 s			

**Notes:**

1. Measured from initial device power supply application.



**Table 11. Power Consumption for 1.8-inch Form Factor**

Specification <sup>1</sup>	Unit	Intel SSD DC S3500			
		80 GB	240 GB	400 GB	800 GB
Active Write - RMS Average @ 3.3V	W	2.0	3.5	4.5	5.2
Active Write - RMS Burst @ 3.3V	W	2.2	3.8	5.0	7.5
Idle @ 3.3V	W	0.6	0.6	0.6	0.6

**Notes:**

1. The workload equates 128 KB (131,072 bytes) Queue Depth equal to 32 sequential writes. Root Mean Squared (RMS) power is measured using scope trigger over a 100 ms sample period.

## 2.4 Environmental Conditions

**Table 12. Temperature, Shock, Vibration**

Temperature	Range
Case Temperature Operating Non-operating <sup>1</sup>	0 – 70 °C -55 – 95 °C
Temperature Gradient <sup>2</sup> Operating Non-operating	30 °C/hr (Typical) 30 °C/hr (Typical)
Humidity Operating Non-operating	5 – 95 % 5 – 95 %
Shock and Vibration	Range
Shock <sup>3</sup> Operating Non-operating	1,000 G (Max) at 0.5 msec 1,000 G (Max) at 0.5 msec
Vibration <sup>4</sup> Operating Non-operating	2.17 G <sub>RMS</sub> (5-700 Hz) Max 3.13 G <sub>RMS</sub> (5-800 Hz) Max

**Notes:**

1. Please contact your Intel representative for details on the non-operating temperature range.
2. Temperature gradient measured without condensation.
3. Shock specifications assume the SSD is mounted securely with the input vibration applied to the drive-mounting screws. Stimulus may be applied in the X, Y or Z axis. Shock specification is measured using Root Mean Squared (RMS) value.
3. Vibration specifications assume the SSD is mounted securely with the input vibration applied to the drive-mounting screws. Stimulus may be applied in the X, Y or Z axis. Vibration specification is measured using RMS value.

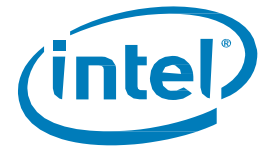

## 2.5 Product Regulatory Compliance

Intel SSD DC S3500 meets or exceeds the regulatory or certification requirements in Table 13.

**Table 13. Product Regulatory Compliance Specifications**

Title	Description	Region For Which Conformity Declared
TITLE 47-Telecommunications CHAPTER 1— FEDERAL COMMUNICATIONS COMMISSION PART 15 — RADIO FREQUENCY DEVICES ICES-003, Issue 4 Interference-Causing Equipment Standard Digital Apparatus	FCC Part 15B Class B  CA/CSA-CEI/IEC CISPR 22:02. This is CISPR 22:1997 with Canadian Modifications	USA  Canada
IEC 55024 Information Technology Equipment — Immunity characteristics— Limits and methods of measurement CISPR24:2010	EN-55024: 1998 and its amendments	European Union
IEC 55022 Information Technology Equipment — Radio disturbance Characteristics— Limits and methods of measurement CISPR24:2008 (Modified)	EN-55022: 2006 and its amendments	European Union
EN-60950-1 2 <sup>nd</sup> Edition	Information Technology Equipment — Safety — Part 1: General Requirements	USA/Canada
UL/CSA EN-60950-1 2 <sup>nd</sup> Edition	Information Technology Equipment — Safety — Part 1: General Requirements	USA/Canada

## 2.6 Reliability

Intel SSD DC S3500 meets or exceeds SSD endurance and data retention requirements as specified in the JESD218 standard. Reliability specifications are listed in the table below:

**Table 14. Reliability Specifications**

Parameter	Value
Uncorrectable Bit Error Rate (UBER)  Uncorrectable bit error rate will not exceed one sector in the specified number of bits read. In the unlikely event of a non-recoverable read error, the SSD will report it as a read failure to the host; the sector in error is considered corrupt and is not returned to the host.	< 1 sector per 10 <sup>17</sup> bits read
Mean Time Between Failures (MTBF)  Mean Time Between Failures is estimated based on Telcordia* methodology and demonstrated through Reliability Demonstration Test (RDT).	2,000,000 hours
Power On/Off Cycles  Power On/Off Cycles is defined as power being removed from the SSD, and then restored. Most host systems remove power from the SSD when entering suspend and hibernate as well as on a system shutdown.	24 per day



**Table 14. Reliability Specifications**

Parameter	Value
Insertion Cycles SATA/power cable insertion/removal cycles.	50 on SATA cable 500 on backplane
Data Retention The time period for retaining data in the NAND at maximum rated endurance.	3 months power-off retention once SSD reaches rated write endurance at 40 °C
Endurance Rating  Based on JESD219 workload.	80 GB: 45 TBW 120 GB: 70 TBW 160 GB: 100 TBW 240 GB: 140 TBW 300 GB: 170 TBW 400 GB: 225 TBW 480 GB: 275 TBW 600 GB: 330 TBW 800 GB: 450 TBW  while running JESD218 standard <sup>1</sup>

1. Refer to JESD218 standard table 1 for UBER, FFR and other Enterprise SSD requirements

## 2.7 Temperature Sensor

The Intel SSD DC S3500 has an internal temperature sensor with an accuracy of +/-2C over a range of -20C to +80C which can be monitored using two SMART attributes: Airflow Temperature (BEh) and Device Internal Temperature (C2h).

For more information on supported SMART attributes, see "SMART Attributes" on page 18.

## 2.8 Power Loss Capacitor Test

The Intel SSD DC S3500 supports testing of the power loss capacitor, which can be monitored using the following SMART attribute: (175, AFh).

## 2.9 Hot Plug Support

Hot Plug insertion and removal is supported in the presence of a proper connector and appropriate operating system (OS), as described in the SATA 3.0 specification.

This product supports asynchronous signal recovery and issues an unsolicited COMINIT when first mated with a powered connector to guarantee reliable detection by a host system without hardware device detection.

### 3.0 Mechanical Information

Figures 1 and 2 show the physical package information for the Intel SSD DC S3500 in the 2.5- and 1.8-inch form factors. All dimensions are in millimeters.

**Figure 1: Intel SSD DC S3500 2.5-inch Dimensions**

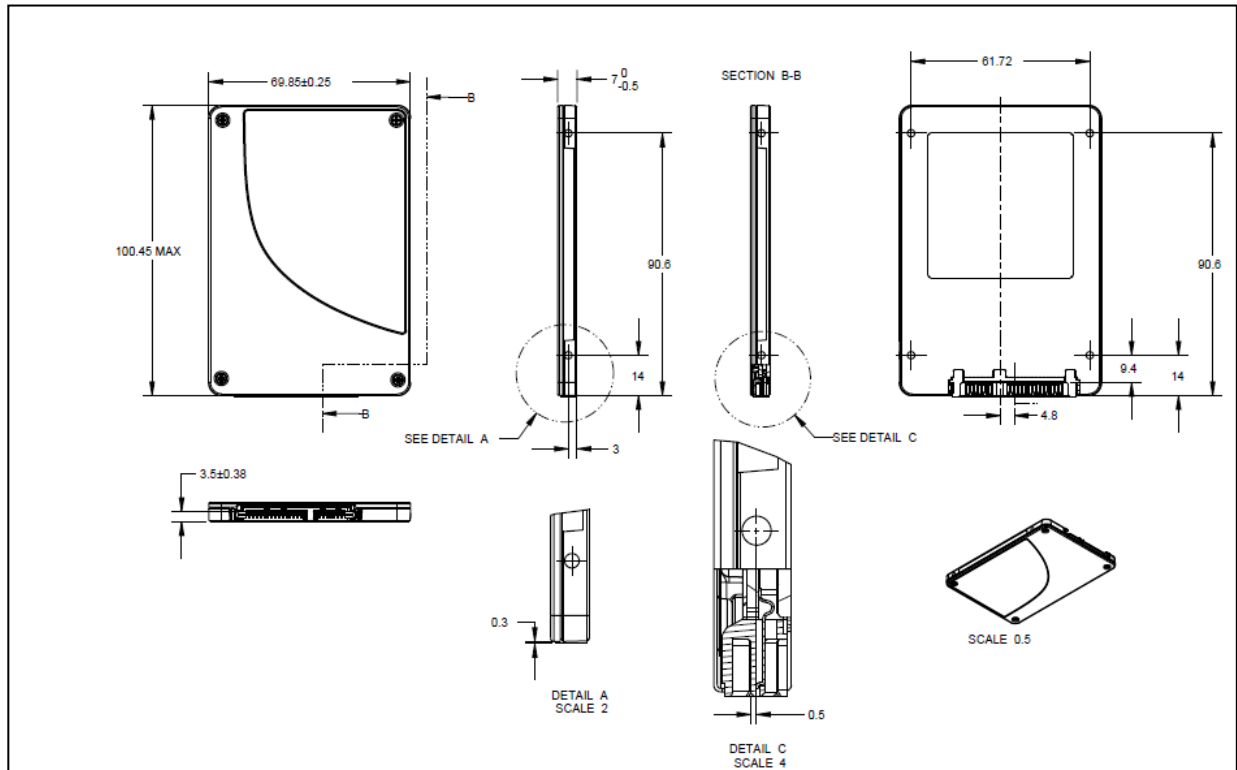

Figure 2: Intel SSD DC S3500 1.8-inch Dimensions



## 4.0 Pin and Signal Descriptions

### 4.1 2.5-inch Form Factor Pin Locations

Figure 3: Layout of 2.5-inch Form Factor Signal and Power Segment Pins

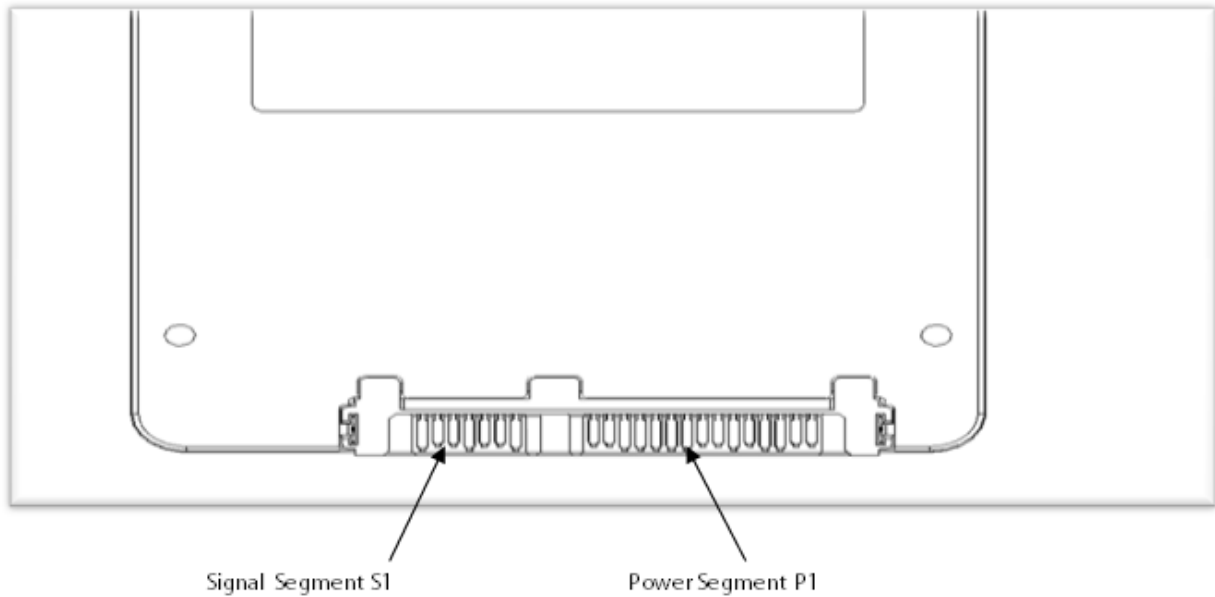

**Note:** 2.5-inch connector supports built in latching capability.

### 4.2 1.8-inch Form Factor Pin Locations

Figure 4: Layout of 1.8-inch Form Factor Signal and Power Segment Pins

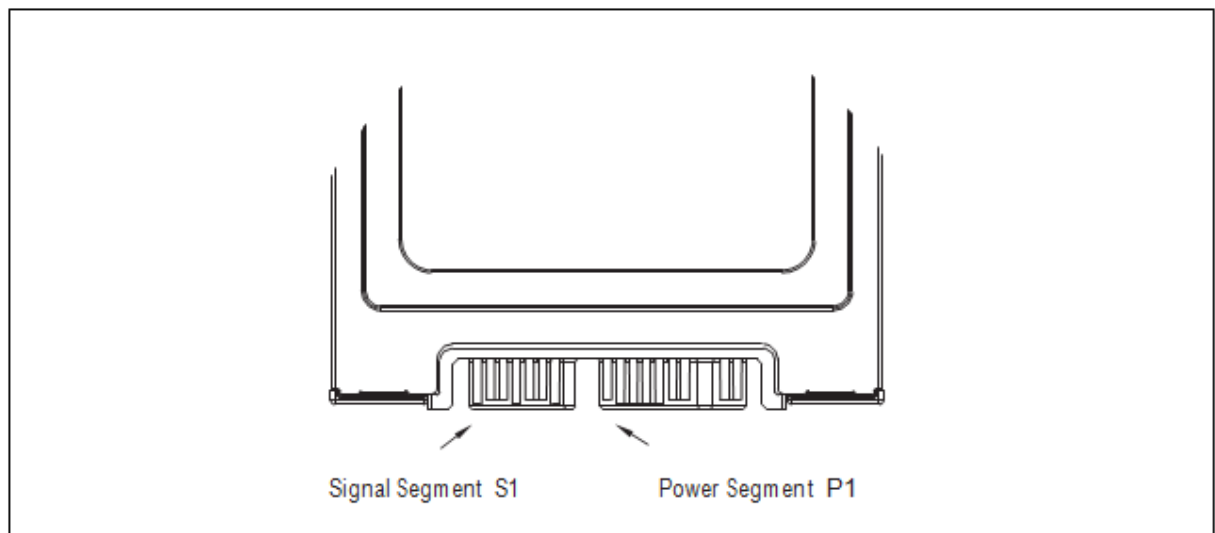



### 4.3 Connector Pin Signal Definitions

**Table 15. Serial ATA Connector Pin Signal Definitions—2.5-inch and 1.8-inch Form Factors**

Pin	Function	Definition
S1	Ground	1 <sup>st</sup> mate
S2	A+	Differential signal pair A
S3	A-	
S4	Ground	1 <sup>st</sup> mate
S5	B-	Differential signal pair B
S6	B+	
S7	Ground	1 <sup>st</sup> mate

**Note:** Key and spacing separate signal and power segments.

### 4.4 Power Pin Signal Definitions

**Table 16. Serial ATA Power Pin Definitions—2.5-inch Form Factors**

Pin <sup>1</sup>	Function	Definition	Mating Order
P1 <sup>2</sup>	Not connected	(3.3 V Power)	--
P2 <sup>2</sup>	Not connected	(3.3 V Power)	--
P3 <sup>2</sup>	Not connected	(3.3 V Power; pre-charge)	2 <sup>nd</sup> Mate
P4 <sup>3,4</sup>	Ground	Ground	1 <sup>st</sup> Mate
P5 <sup>3</sup>	Ground	Ground	1 <sup>st</sup> Mate
P6 <sup>3</sup>	Ground	Ground	1 <sup>st</sup> Mate
P7 <sup>3,5</sup>	V <sub>5</sub>	5 V Power	1 <sup>st</sup> Mate
P8 <sup>3,5</sup>	V <sub>5</sub>	5 V Power	2 <sup>nd</sup> Mate
P9 <sup>3,5</sup>	V <sub>5</sub>	5 V Power	2 <sup>nd</sup> Mate
P10 <sup>3</sup>	Ground	Ground	1 <sup>st</sup> Mate
P11 <sup>6</sup>	DAS/DSS	Device Activity Signal/Disable Staggered Spin-up	2 <sup>nd</sup> Mate
P12 <sup>3,4</sup>	Ground	Ground	1 <sup>st</sup> Mate
P13 <sup>7</sup>	V <sub>12</sub>	12 V Power	1 <sup>st</sup> Mate
P14 <sup>7</sup>	V <sub>12</sub>	12 V Power	2 <sup>nd</sup> Mate
P15 <sup>7</sup>	V <sub>12</sub>	12 V Power	2 <sup>nd</sup> Mate

**Notes:**

- All pins are in a single row, with a 1.27 mm (0.050-inch) pitch.
- Pins P1, P2 and P3 are connected together, although they are not connected internally to the device. The host may put 3.3 V on these pins.
- The mating sequence is:
  - ground pins P4-P6, P10, P12 and the 5V power pin P7
  - signal pins and the rest of the 5V power pins P8-P9
- Ground connectors P4 and P12 may contact before the other 1st mate pins in both the power and signal connectors to discharge ESD in a suitably configured backplane connector.
- Power pins P7, P8, and P9 are internally connected to one another within the device.
- The host may ground P11 if it is not used for Device Activity Signal (DAS).
- Pins P13, P14 and P15 are internally connected to one another within the device. The host may put 12 V on these pins.

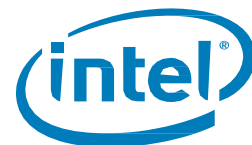

**Table 17. Serial ATA Power Pin Definitions—1.8-inch Form Factors**

Pin	Function	Definition	Mating Order <sup>1</sup>
P1 <sup>2</sup>	V <sub>33</sub>	3.3 V Power	2 <sup>nd</sup> Mate
P2 <sup>2</sup>	V <sub>33</sub>	3.3 V Power, per-charge	2 <sup>nd</sup> Mate
P3 <sup>3</sup>	Ground	--	1 <sup>st</sup> Mate
P4 <sup>3</sup>	Ground	--	1 <sup>st</sup> Mate
P5 <sup>4</sup>	V <sub>5</sub>	5 V Power; not connected.	1 <sup>st</sup> Mate
P6 <sup>4</sup>	V <sub>5</sub>	5 V Power; not connected.	2 <sup>nd</sup> Mate
P7 <sup>5</sup>	DAS/DSS	Device Activity Signal/Disable Staggered Spin-up	2 <sup>nd</sup> Mate
Key	Key	NC	NC
P8 <sup>6</sup>	Optional	Manufacturing Test Pin	2 <sup>nd</sup> Mate
P9 <sup>6</sup>	Optional	Manufacturing Test Pin	2 <sup>nd</sup> Mate

**Notes:**

1. All mate sequences assume zero angular offset between connectors.
2. P1 and P2 are internally connected to one another within the device.
3. Ground connectors P3 and P4 may contact before the other 1st mate pins in both the power and signal connectors to discharge ESD in a suitably configured backplane connector.
4. Pins P5 and P6 are not connected internally to the device but there is an option to connect through a zero ohm stuffing resistor. The host may put 5V on these pins.
5. The host may ground P7 if it is not used for Device Activity Signal (DAS).
6. P8 and P9 should not be connected by the host.



## 5.0 Supported Command Sets

Intel SSD DC S3500 supports all mandatory ATA (Advanced Technology Attachment) commands defined in the ATA8-ACS specification described in this section.

### 5.1 ATA General Feature Command Set

The Intel SSD DC S3500 supports the ATA General Feature command set (non- PACKET), which consists of:

- EXECUTE DEVICE DIAGNOSTIC
- SET FEATURES
- IDENTIFY DEVICE

**Note:** See Appendix A, "IDENTIFY DEVICE Command Data" on page 27 for details on the sector data returned after issuing an IDENTIFY DEVICE command.

Intel SSD DC S3500 also supports the following optional commands:

- READ DMA
- WRITE DMA
- READ SECTOR(S)
- READ VERIFY SECTOR(S)
- READ MULTIPLE
- SEEK
- SET FEATURES
- WRITE SECTOR(S)
- SET MULTIPLE MODE<sup>1</sup>
- WRITE MULTIPLE
- FLUSH CACHE
- READ BUFFER
- WRITE BUFFER
- NOP
- DOWNLOAD MICROCODE
- WRITE UNCORRECTABLE EXT

1. The only multiple supported will be multiple 1

### 5.2 Power Management Command Set

Intel SSD DC S3500 supports the Power Management command set, which consists of:

- CHECK POWER MODE
- IDLE
- IDLE IMMEDIATE
- SLEEP
- STANDBY
- STANDBY IMMEDIATE

### 5.3 Security Mode Feature Set

Intel SSD DC S3500 supports the Security Mode command set, which consists of:

- SECURITY SET PASSWORD
- SECURITY UNLOCK
- SECURITY ERASE PREPARE
- SECURITY ERASE UNIT
- SECURITY FREEZE LOCK
- SECURITY DISABLE PASSWORD



## 5.4 SMART Command Set

Intel SSD DC S3500 supports the SMART command set, which consists of:

- SMART READ DATA
- SMART READ ATTRIBUTE THRESHOLDS
- SMART ENABLE/DISABLE ATTRIBUTE AUTOSAVE
- SMART SAVE ATTRIBUTE VALUES
- SMART EXECUTE OFF-LINE IMMEDIATE
- SMART READ LOG SECTOR
- SMART WRITE LOG SECTOR
- SMART ENABLE OPERATIONS
- SMART DISABLE OPERATIONS
- SMART RETURN STATUS
- SMART ENABLE/DISABLE AUTOMATIC OFFLINE

### 5.4.1 SMART Attributes

Table 18 lists the SMART attributes supported by the Intel SSD DC S3500 and the corresponding status flags and threshold settings.

**Table 18. SMART Attributes**

ID	Attribute	Status Flags						Threshold
		SP	EC	ER	PE	OC	PW	
05h	Re-allocated Sector Count <i>Raw value:</i> shows the number of retired blocks since leaving the factory (grown defect count). <i>Normalized value:</i> beginning at 100, shows the percent remaining of allowable grown defect count.	1	1	0	0	1	0	0 (none)
09h	Power-On Hours Count <i>Raw value:</i> reports power-on time, cumulative over the life of the SSD, integer number in hour time units. <i>Normalized value:</i> always 100.	1	1	0	0	1	0	0 (none)
0Ch	Power Cycle Count <i>Raw value:</i> reports the cumulative number of power cycle events over the life of the device. <i>Normalized value:</i> always 100.	1	1	0	0	1	0	0 (none)
AAh	Available Reserved Space (See Attribute E8)	1	1	0	0	1	1	10
ABh	Program Fail Count <i>Raw value:</i> shows total count of program fails. <i>Normalized value:</i> beginning at 100, shows the percent remaining of allowable program fails.	1	1	0	0	1	0	0 (none)
ACH	Erase Fail Count <i>Raw value:</i> shows total count of erase fails. <i>Normalized value:</i> beginning at 100, shows the percent remaining of allowable erase fails.	1	1	0	0	1	0	0 (none)
AEnh	Unexpected Power Loss Also known as "Power-off Retract Count" per magnetic-drive terminology. <i>Raw value:</i> reports number of unclean shutdowns, cumulative over the life of the SSD. An "unclean shutdown" is the removal of power without STANDBY IMMEDIATE as the last command (regardless of PLI activity using capacitor power). <i>Normalized value:</i> always 100.	1	1	0	0	1	0	0 (none)
AFh	Power Loss Protection Failure Last test result as microseconds to discharge cap, saturates at max value. Also logs minutes since last test and lifetime number of tests. <i>Raw value:</i> Bytes 0-1: Last test result as microseconds to discharge cap, saturates at max value. Test result expected in range	1	1	0	0	1	1	10



**Table 18. SMART Attributes**

ID	Attribute	Status Flags						Threshold
		SP	EC	ER	PE	OC	PW	
	<p>25 &lt;= result &lt;= 5000000, lower indicates specific error code.</p> <p>Bytes 2-3: Minutes since last test, saturates at max value.</p> <p>Bytes 4-5: Lifetime number of tests, not incremented on power cycle, saturates at max value.</p> <p><i>Normalized value:</i> set to 1 on test failure or 11 if the capacitor has been tested in an excessive temperature condition, otherwise 100.</p>							
B7h	<p>SATA Downshift Count</p> <p><i>Raw value:</i> reports number of times SATA interface selected lower signaling rate due to error.</p> <p><i>Normalized value:</i> always 100.</p>	1	1	0	0	1	0	0 (none)
B8h	<p>End-to-End Error Detection Count</p> <p><i>Raw value:</i> reports number of End-to-End detected and corrected errors by hardware.</p> <p><i>Normalized value:</i> always 100.</p>	1	1	0	0	1	0	0 (none)
BBh	<p>Uncorrectable Error Count</p> <p><i>Raw value:</i> shows the number of errors that could not be recovered using Error Correction Code (ECC).</p> <p><i>Normalized value:</i> always 100.</p>	1	1	0	0	1	0	0 (none)
BEh	<p>Temperature - Airflow Temperature (Case)</p> <p><i>Raw value:</i> reports SSD case temperature statistics.</p> <p>Bytes 0-1: Current case temperature, Celsius</p> <p>Byte 2: Recent min case temperature, Celsius</p> <p>Byte 3: Recent max case temperature, Celsius</p> <p>Bytes 4-5: Over temperature counter. Number of times sampled temperature exceeds drive max operating temperature specification.</p> <p><i>Normalized value:</i> 100 - case temperature in C degrees.</p>	1	0	0	0	1	0	0 (none)
C0h	<p>Power-Off Retract Count (Unsafe Shutdown Count)</p> <p><i>Raw value:</i> reports the cumulative number of unsafe (unclean) shutdown events over the life of the device. An unsafe shutdown occurs whenever the device is powered off without STANDBYIMMEDIATE being the last command.</p> <p><i>Normalized value:</i> always 100.</p>	1	1	0	0	1	0	0 (none)
C2h	<p>Temperature - Device Internal Temperature</p> <p><i>Raw value:</i> Reports internal temperature of the SSD in degrees Celsius. Temperature reading is the value direct from the printed circuit board (PCB) sensor without offset.</p> <p><i>Normalized value:</i> 150 - device temperature in C degrees, 100 if device temperature less than 50.</p>	1	0	0	0	1	0	0 (none)
C5h	<p>Pending Sector Count</p> <p><i>Raw value:</i> number of current unrecoverable read errors that will be re-allocated on next write.</p> <p><i>Normalized value:</i> always 100.</p>	0	1	0	0	1	0	0 (none)
C7h	<p>CRC Error Count</p> <p><i>Raw value:</i> shows total number of encountered SATA interface cyclic redundancy check (CRC) errors.</p> <p><i>Normalized value:</i> always 100.</p>	1	1	0	0	1	0	0 (none)
E1h	<p>Host Writes</p> <p><i>Raw value:</i> reports total number of sectors written by the host system. The raw value is increased by 1 for every 65,536 sectors (32MB) written by the host.</p> <p><i>Normalized value:</i> always 100.</p>	1	1	0	0	1	0	0 (none)



Table 18. SMART Attributes

ID	Attribute	Status Flags						Threshold
		SP	EC	ER	PE	OC	PW	
E2h	Timed Workload Media Wear <i>Raw value:</i> measures the wear seen by the SSD (since reset of the workload timer, attribute E4h), as a percentage of the maximum rated cycles. Divide the raw value by 1024 to derive the percentage with 3 decimal points. <i>Normalized value:</i> always 100.	1	1	0	0	1	0	0 (none)
E3h	Timed Workload Host Read/Write Ratio <i>Raw value:</i> shows the percentage of I/O operations that are read operations (since reset of the workload timer, attribute E4h). Reported as integer percentage from 0 to 100. <i>Normalized value:</i> always 100.	1	1	0	0	1	0	0 (none)
E4h	Timed Workload Timer <i>Raw value:</i> measures the elapsed time (number of minutes since starting this workload timer). <i>Normalized value:</i> always 100.	1	1	0	0	1	0	0 (none)
E8h	Available Reserved Space <i>Raw value:</i> reports number of reserve blocks remaining. <i>Normalized value:</i> begins at 100, which corresponds to 100 percent availability of the reserved space. The threshold value for this attribute is 10 percent availability.	1	1	0	0	1	1	10
E9h	Media Wearout Indicator <i>Raw value:</i> always 0. <i>Normalized value:</i> reports the number of cycles the NAND media has undergone. Declines linearly from 100 to 1 as the average erase cycle count increases from 0 to the maximum rated cycles. Once the normalized value reaches 1, the number will not decrease, although it is likely that significant additional wear can be put on the device.	1	1	0	0	1	0	0 (none)
EAh	Thermal Throttle Status <i>Raw value:</i> reports Percent Throttle Status and Count of events Byte 0: Throttle status reported as integer percentage. Bytes 1-4: Throttling event count. Number of times thermal throttle has activated. Preserved over power cycles. Byte 5: Reserved. <i>Normalized value:</i> always 100.	1	1	0	0	1	0	0 (none)
F1h	Total LBAs Written <i>Raw value:</i> reports the total number of sectors written by the host system. The raw value is increased by 1 for every 65,536 sectors (32MB) written by the host. <i>Normalized value:</i> always 100.	1	1	0	0	1	0	0 (none)
F2h	Total LBAs Read <i>Raw value:</i> reports the total number of sectors read by the host system. The raw value is increased by 1 for every 65,536 sectors (32MB) read by the host. <i>Normalized value:</i> always 100.	1	1	0	0	1	0	0 (none)

**Table 19. SMART Attribute Status Flags**

Status Flag	Description	Value = 0	Value = 1
SP	Self-preserving attribute	Not a self-preserving attribute	Self-preserving attribute
EC	Event count attribute	Not an event count attribute	Event count attribute
ER	Error rate attribute	Not an error rate attribute	Error rate attribute
PE	Performance attribute	Not a performance attribute	Performance attribute
OC	Online collection attribute	Collected only during offline activity	Collected during both offline and online activity
PW	Pre-fail warranty attribute	Advisory	Pre-fail

### 5.4.1 Timed Workload Endurance Indicators

#### Timed Workload Media Wear Indicator – ID E2h

This attribute tracks the drive wear seen by the device during the last wear timer loop, as a percentage of the maximum rated cycles. The raw value tracks the percentage up to 3 decimal points. This value should be divided by 1024 to get the percentage.

For example: if the raw value is 4450, the percentage is  $4450/1024 = 4.345\%$ . The raw value is held at FFFFh until the wear timer (attribute E4h) reaches 60 (minutes). The normalized value is always set to 100 and should be ignored.

#### Timed Workload Host Reads Percentage – ID E3h

This attribute shows the percentage of I/O operations that are read operations during the last workload timer loop. The raw value tracks this percentage and is held at FFFFh until the workload timer (attribute E4h) reaches 60 (minutes). The normalized value is always set to 100 and should be ignored.

#### Workload Timer – ID E4h

This attribute is used to measure the time elapsed during the current workload. The attribute is reset when a SMART EXECUTE OFFLINE IMMEDIATE (D4h) subcommand 40h is issued to the drive. The raw value tracks the time in minutes and has a maximum value of  $232 = 4,294,967,296$  minutes (8,171 years). The normalized value is always set to 100 and should be ignored.

#### Example Use Cases

The Timed Workload Endurance attributes described in this section are intended to be used to measure the amount of media wear that the drive is subjected to during a timed workload.

Ideally, the system that the drive is being used in should be capable of issuing SMART commands. Otherwise, provisions have been provided to allow the media wear attributes to be persistent so the drive can be moved to a SMART capable system to read out the drive wear attribute values.

#### Use Case 1 – With a System Capable of SMART Commands

1. Issue the SMART EXECUTE OFF-LINE IMMEDIATE (D4h) sub-command 40h to reset the drive wear attributes.
2. Run the workload to be evaluated for at least 60 minutes. Otherwise the drive wear attributes will not be available.
3. Read out the drive wear attributes with the SMART READ DATA (D0h) command.

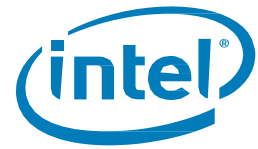

### Use Case 2 – With a System Not Capable of SMART Commands

1. On a SMART capable system, issue the SMART EXECUTE OFF-LINE IMMEDIATE (D4h) sub-command 40h to reset the E4h (workload timer) attribute.
2. Move the drive to the system where the workload will be measured (and not capable of SMART commands).
3. Run the workload to be evaluated for at least 60 minutes. Otherwise the drive wear attributes will not be available.
4. Do a clean system power down by issuing the ATA STANDBY IMMEDIATE command prior to shutting down the system. This will store all the drive wear SMART attributes to persistent memory within the drive.
5. Move the drive to a SMART capable system.
6. Read out the drive wear attributes with the SMART READ DATA (D0h) command within 60 minutes after power-up.

### Example Calculation of Drive Wear

The following is an example of how the drive wear attributes can be used to evaluate the impact of a given workload. The Host Writes SMART attribute (E1h) can also be used to calculate the amount of data written by the host during the workload by reading this attribute before and after running the workload. This example assumes that the steps shown in “Example Use Cases” on page 18 were followed to obtain the following attribute values:

- Timed Workload Media Wear (E2h) has a raw value of 16. Therefore, the percentage wear =  $16/1024 = 0.016\%$ .
- Timed Workload Host Read/Write Ratio (E3h) has a normalized value of 80, indicating that 80% of operations were reads.
- Workload Timer (E4h) has a raw value of 500. Therefore the workload ran for 500 minutes.
- Host Writes Count (E1h) had a raw value of 100,000 prior to running the workload and a value of 130,000 at the end of the workload. Therefore, the number of sectors written by the host during the workload was  $30,000 * 65,535 = 1,966,050,000$  sectors or  $1,966,050,000 * 512/1,000,000,000 = 1,007$  GB.

The following conclusions can be made for this example case:

The workload took 500 minutes to complete with 80% reads and 20% writes. A total of 1,007 GB of data was written to the device, which increased the media wear in the drive by 0.016%. At this point in time, this workload is causing a wear rate of 0.016% for every 500 minutes, or 0.00192%/hour.

## 5.4.2 SMART Logs

Intel SSD DC S3500 implements the following Log Addresses: 00h, 02h, 03h, 06h, and 07h.

DC S3500 implements host vendor specific logs (addresses 80h-9Fh) as read and write scratchpads, where the default value is zero (0). Intel SSD DC S3500 does not write any specific values to these logs unless directed by the host through the appropriate commands.

DC S3500 also implements a device vendor specific log at address A9h as a read-only log area with a default value of zero (0).



## 5.5 Device Statistics

In addition to the SMART attribute structure, statistics pertaining to the operation and health of the Intel SSD DC S3500 can be reported to the host on request through the Device Statistics log as defined in the ATA specification.

The Device Statistics log is a read-only GPL/SMART log located at read log address 0x04 and is accessible using READ LOG EXT, READ LOG DMA EXT or SMART READ LOG commands.

Table 20 lists the Device Statistics supported by the Intel SSD DC S3500.

**Table 20. Device Statistics Log**

Page	Offset	Description	Equivalent SMART attribute (if applicable)
0x00	--	List of Supported Pages	--
0x01 – General Statistics	0x08	Power Cycle Count	0Ch
	0x10	Power-On Hours	09h
	0x18	Logical Sectors Written	E1h
	0x20	Num Write Commands – incremented by one for every host write	--
	0x28	Logical Sectors Read	F2h
	0x30	Num Read Commands – incremented by one for every host read	--
0x04 – General Error Statistics	0x08	Num Reported Uncorrectable Errors	BBh
	0x10	Num Resets Between Command Acceptance and Completion	--
0x05 – Temperature Statistics	0x00	Device Statistics Information Header	--
	0x08	Current Temperature	--
	0x10	Average Short Term Temperature	--
	0x18	Average Long Term Temperature	--
	0x20	Highest Temperature	--
	0x28	Lowest Temperature	--
	0x30	Highest Average Short Term Temperature	--
	0x38	Lowest Average Short Term Temperature	--
	0x40	Highest Average Long Term Temperature	--
	0x48	Lowest Average Long Term Temperature	--
	0x50	Time in Over-Temperature	--
	0x58	Specified Maximum Operating Temperature	--
	0x60	Time in Under-Temperature	--
	0x68	Specified Minimum Operating Temperature	--
0x06 – Transport Statistics	0x08	Number of Hardware Resets	--
	0x10	Number of ASR Events	--
	0x18	Number of Interface CRC Errors	--
0x07 – Solid State Device Statistics	0x08	Percentage Used Endurance Indicator	E9h Note: This device statistic counts from 1 to 150



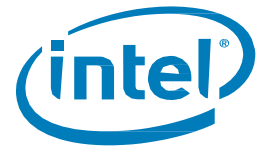

## 5.6 SMART Command Transport (SCT)

With SMART Command Transport (SCT), a host can send commands and data to an SSD and receive status and data from an SSD using standard write/read commands to manipulate two SMART Logs:

- Log Address E0h ("SCT Command/Status") — used to send commands and retrieve status
- Log Address E1h ("SCT Data Transfer") — used to transport data

Intel SSD DC S3500 supports the following standard SCT actions:

- Write Same — DC S3500 implements this action code as described in the ATA specification.
- Error Recovery Control — DC S3500 accepts this action code, and will store and return error-recovery time limit values.
- Feature Control - DC S3500 supports feature code 0001h (write cache) feature code 0002h (write cache reordering), and feature code 0003h (time interval for temperature logging). It also supports D000h(Power Safe Write Cache capacitor test interval), (D001h(read/write power governor mode), D002h(read thermal governor mode), D003h(read power governor burst power), D004h(read power governor average power).
- Data table command - DC S3500 supports data table command as specified in ATA8-ACS2. This will read out temperature logging information in table ID 0002h.
- Read Status Support - DC S3500 supports read status log

## 5.7 Data Set Management Command Set

Intel SSD DC S3500 supports the Data Set Management command set Trim attribute, which consists of:

- DATA SET MANAGEMENT

## 5.8 Host Protected Area Command Set

Intel SSD DC S3500 supports the Host Protected Area command set, which consists of:

- READ NATIVE MAX ADDRESS
- SET MAX ADDRESS
- READ NATIVE MAX ADDRESS EXT
- SET MAX ADDRESS EXT

Intel SSD DC S3500 also supports the following optional commands:

- SET MAX SET PASSWORD
- SET MAX LOCK
- SET MAX FREEZE LOCK
- SET MAX UNLOCK

## 5.9 48-Bit Address Command Set

Intel SSD DC S3500 supports the 48-bit Address command set, which consists of:

- FLUSH CACHE EXT
- READ DMA EXT
- READ NATIVE MAX ADDRESS EXT
- READ SECTOR(S) EXT
- READ VERIFY SECTOR(S) EXT
- SET MAX ADDRESS EXT
- WRITE DMA EXT
- WRITE MULTIPLE EXT
- WRITE SECTOR(S) EXT
- WRITE MULTIPLE FUA EXT
- WRITE DMA FUA EXT

## 5.10 General Purpose Log Command Set

Intel SSD DC S3500 supports the General Purpose Log command set, which consists of:

- READ LOG EXT
- WRITE LOG EXT

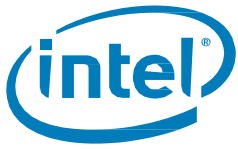

## **5.11 Native Command Queuing**

Intel SSD DC S3500 supports the Native Command Queuing (NCQ) command set, which includes:

- READ FPDMA QUEUED
- WRITE FPDMA QUEUED

**Note:** With a maximum Queue Depth set to 32.

## **5.12 Software Settings Preservation**

Intel SSD DC S3500 supports the SET FEATURES parameter to enable/disable the preservation of software settings.



## 6.0 Certifications and Declarations

Table 21 describes the Device Certifications supported by the Intel SSD DC S3500.

**Table 21. Device Certifications and Declarations**

Certification	Description
CE Compliant	Low Voltage DIRECTIVE 2006/95/EC OF THE EUROPEAN PARLIAMENT AND OF THE COUNCIL of 12 December 2006, and EMC Directive 2004/108/EC OF THE EUROPEAN PARLIAMENT AND OF THE COUNCIL of 15 December 2004.
UL Recognized	Underwriters Laboratories, Inc. Bi-National Component Recognition; UL 60950-1, 2nd Edition, 2007-03-27 (Information Technology Equipment - Safety - Part 1: General Requirements) CSA C22.2 No. 60950-1-07, 2nd Edition, 2007-03 (Information Technology Equipment - Safety - Part 1: General Requirements)
C-Tick Compliant	Compliance with the Australia/New Zealand Standard AS/NZS3548 and Electromagnetic Compatibility (EMC) Framework requirements of the Australian Communication Authority (ACA).
BSMI Compliant	Compliance to the Taiwan EMC standard CNS 13438: Information technology equipment - Radio disturbance Characteristics - limits and methods of measurement, as amended on June 1, 2006, is harmonized with CISPR 22: 2005.04.
KCC	Compliance with paragraph 1 of Article 11 of the Electromagnetic Compatibility Control Regulation and meets the Electromagnetic Compatibility (EMC) Framework requirements of the Radio Research Laboratory (RRL) Ministry of Information and Communication Republic of Korea.
VCCI	Voluntary Control Council for Interface to cope with disturbance problems caused by personal computers or facsimile.
RoHS Compliant	Restriction of Hazardous Substance Directive
WEEE	Directive on Waste Electrical and Electronic Equipment

## 7.0 References

Table 22 identifies the standards information referenced in this document.

**Table 22. Standards References**

Date	Title	Location
July 2012	Solid-State Drive (SSD) Requirements and Endurance Test Method (JESD219)	<a href="http://www.jedec.org/standards-documents/results/jesd219">http://www.jedec.org/standards-documents/results/jesd219</a>
Sept 2010	Solid-State Drive (SSD) Requirements and Endurance Test Method (JESD218)	<a href="http://www.jedec.org/standards-documents/docs/jesd218/">http://www.jedec.org/standards-documents/docs/jesd218/</a>
Dec 2008	VCCI	<a href="http://www.vcci.jp/vcci_e/">http://www.vcci.jp/vcci_e/</a>
June 2009	RoHS	<a href="http://qdms.intel.com/">http://qdms.intel.com/</a> Click <i>Search MDDS Database</i> and search for material description datasheet
August 2009	ACS-2-ATA/ATAPI Command Set 2 Specification	<a href="http://www.t13.org/">http://www.t13.org/</a>
June 2009	Serial ATA Revision 3.0	<a href="http://www.sata-io.org/">http://www.sata-io.org/</a>
May 2006	SFF-8223, 2.5-inch Drive w/Serial Attachment Connector	<a href="http://www.sffcommittee.org/">http://www.sffcommittee.org/</a>



May 2005	SFF-8201, 2.5-inch drive form factor	<a href="http://www.sffcommittee.org/">http://www.sffcommittee.org/</a>
1995 1996 1995 1995 1997 1994	International Electrotechnical Commission EN 61000 4-2 (Electrostatic discharge immunity test) 4-3 (Radiated, radio-frequency, electromagnetic field immunity test) 4-4 (Electrical fast transient/burst immunity test) 4-5 (Surge immunity test) 4-6 (Immunity to conducted disturbances, induced by radio-frequency fields) 4-11 (Voltage Variations, voltage dips, short interruptions and voltage variations immunity tests)	<a href="http://www.iec.ch/">http://www.iec.ch/</a>
1995	ENV 50204 (Radiated electromagnetic field from digital radio telephones)	<a href="http://www.dbicorporation.com/radimmun.htm/">http://www.dbicorporation.com/radimmun.htm/</a>

## Appendix A: IDENTIFY DEVICE Command Data

Table 23. Returned Sector Data

Word	F = Fixed V = Variable X = Both	Default Value	Description
0	X	0040h	General configuration bit-significant information
1	X	3FFFh	Obsolete - Number of logical cylinders (16,383)
2	V	C837h	Specific configuration
3	X	0010h	Obsolete - Number of logical heads (16)
4-5	X	0h	Retired
6	X	003Fh	Obsolete - Number of logical sectors per logical track (63)
7-8	V	0h	Reserved for assignment by the CompactFlash* Association (CFA)
9	X	0h	Retired
10-19	F	varies	Serial number (20 ASCII characters)
20-21	X	0h	Retired
22	X	0h	Obsolete
23-26	F	varies	Firmware revision (8 ASCII characters)
27-46	F	varies	Model number (Intel® Solid-State Drive)
47	F	8001h	7:0—Maximum number of sectors transferred per interrupt on multiple commands
48	F	4000h	Trusted Computing Feature Set
49	F	2F00h	Capabilities
50	F	4000h	Capabilities
51-52	X	0h	Obsolete
53	F	0007h	Words 88 and 70:64 valid
54	X	3FFFh	Obsolete - Number of logical cylinders (16,383)
55	X	0010h	Obsolete - Number of logical heads (16)
56	X	003Fh	Obsolete - Number of logical sectors per logical track (63)
57-58	X	FC1000FBh	Obsolete
59	F	B101	Number of sectors transferred per interrupt on multiple commands
60-62	V	80GB: 0A000000h 120GB: 0F000000h 160GB: 14000000h 240GB: 1E000000h 300GB: 25800000h 400GB: 32000000h 480GB: 3C000000h	Total number of user-addressable sector



Table 23. Returned Sector Data

Word	F = Fixed V = Variable X = Both	Default Value	Description
		600GB: 4B000000h 800GB: 64000000h	
63	X	0007h	Multi-word DMA modes supported/selected
64	F	0003h	PIO modes supported
65	F	0078h	Minimum multiword DMA transfer cycle time per word
66	F	0078h	Manufacturer's recommended multiword DMA transfer cycle time
67	F	0078h	Minimum PIO transfer cycle time without flow control
68	F	0078h	Minimum PIO transfer cycle time with IORDY flow control
69	F	4030h	Additional Supported
70	F	0000h	Reserved
71-74	F	0h	Reserved for IDENTIFY PACKET DEVICE command
75	F	001Fh	Queue depth
76	F	850Eh	Serial ATA capabilities
77	F	0006h	Reserved for future Serial ATA definition
78	F	0040h	Serial ATA features supported
79	V	0040h	Serial ATA features enabled
80	F	01FCh	Major version number
81	F	0029h	Minor version number
82	F	746Bh	Command set supported
83	F	7501h	Command sets supported
84	F	6163h	Command set/feature supported extension
85	X	7469h	Command set/feature enabled
86	X	B401h	Command set/feature enabled
87	X	6163h	Command set/feature default
88	X	407Fh	Ultra DMA Modes
89	F	0001h	Time required for security erase unit completion
90	F	0001h	Time required for enhanced security erase completion
91	V	0h	Current advanced power management value
92	V	0FFFEh	Master Password Revision Code
93	X	0h	Hardware reset result: the contents of bits (12:0) of this word shall change only during the execution of a hardware reset
94	V	0h	Vendor's recommended and actual acoustic management value
95	F	0h	Stream minimum request size
96	V	0h	Streaming transfer time - DMA
97	V	0h	Streaming access latency - DMA and PIO
98-99	F	0h	Streaming performance granularity
100-103	V	80GB: 0950F8B0h 120GB: 0DF94BB0h 160GB: 12A19EB0h 240GB: 1BF244B0h 300GB: 22EEC130h 400GB: 2E9390B0h 480GB: 37E436B0h 600GB: 45DD2FB0h 800GB: 5D26CEB0h	Maximum user LBA for 48-bit address feature set
104	V	0h	Streaming transfer time - PIO
105	V	0006h	Maximum number of 512-byte blocks of LBA Range Entries per DATA SET MANAGEMENT command

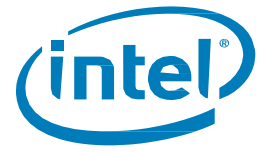

**Table 23. Returned Sector Data**

Word	F = Fixed V = Variable X = Both	Default Value	Description
106	F	4000h	Physical sector size / logical sector size
107	F	0h	Inter-seek delay for ISO-7779 acoustic testing in microseconds
108-111	F	varies	Unique ID
112-115	F	0h	Reserved for world wide name extension to 128 bits
116	V	0h	Reserved for technical report
117-118	F	0h	Words per logical sector
119	F	405Ch	Supported settings
120	X	401Ch	Command set/feature enabled/supported
121-126	F	0h	Reserved
127	X	0h	Removable Media Status Notification feature set support
128	X	0021h	Security status
129	V	001Eh	Vendor-specific
130-159	X	0h	Vendor-specific
160	X	0h	CompactFlash Association (CFA) power mode 1
161-167	X	0h	Reserved for assignment by the CFA
168	X	0003h	Reserved for assignment by the CFA
169	X	0001h	Data set management Trim attribute support
170-175	F	0h	Reserved for assignment by the CFA
176-205	V	Varies	Current media serial number
206	X	003Dh	SCT Command Transport
207-208	F	0000h	Reserved
209	X	4000h	Alignment of logical blocks within a physical block
210-211	V	0000h	Write-Read-Verify Sector Count Mode 3 (DWord)
212-213	F	0000h	Write-Read-Verify Sector Count Mode 2 (DWord)
214	X	0000h	NV Cache Capabilities
215-216	V	0000h	NV Cache Size in Logical Blocks (DWord)
217	F	0001h	Nominal media rotation rate
218	V	0000h	Reserved
219	F	0000h	NV Cache Options
220	V	0000h	Write-Read-Verify feature set
221	X	0000h	Reserved
222	F	101Fh	Transport major version number
223	F	0000h	Transport minor version number
224-229	F	0000h	Reserved
230-233	X	0000h	Extended Number of User Addressable Sectors (QWord)
234	F	0001h	Minimum number of 512-byte data blocks per DOWNLOAD MICROCODE command for mode 03h
235	F	FFFFh	Maximum number of 512-byte data blocks per DOWNLOAD MICROCODE command for mode 03h
236-254	X	0000h	Reserved
255	V	52A5	Integrity word

**Notes:** **F = Fixed.** The content of the word is fixed and does not change. For removable media devices, these values may change when media is removed or changed.

**V = Variable.** The state of at least one bit in a word is variable and may change depending on the state of the device or the commands executed by the device.



**X = F or V.** The content of the word may be fixed or variable.