

User manual

ONLINE ZINTO-series Models 800 – 3000

Germany

ONLINE USV-Systeme AG
Luise-Ullrich-Str. 8
D-82031 Grünwald

Phone +49 (89) 2423990-10
Fax +49 (89) 2423990-20

www.online-usv.de

Italy

ONLINE UPS-Systems S.r.l.
Via Ferruccio Gilera 110
I-20862 Arcore (MB)

Phone +39 (039) 2051444
Fax +39 (039) 2051435

www.online-ups.it

Switzerland

ONLINE USV-Systeme AG
c/o POTESTA AG
Hertistrasse 29
8304 Wallisellen (Zürich)

Phone +49 (89) 242399010
Fax +49 (89) 242399020

www.online-usv.ch

Content

User manual	1
1. Introduction.....	5
2. Safety warnings	7
3. Installation	8
3.1 Checking the delivery	8
3.2 Unpacking the UPS system	8
3.3 Checking the accessories	9
3.4 Installation as tower, activating battery	9
3.5 Installation in a rack, activating the batteries	11
3.6 Getting started	13
4. Operation.....	15
4.1 Control panel	15
4.2 Display and menu.....	17
4.3 Settings	19
4.4 Operating statuses	21
5. Communication and interfaces.....	23
5.1 RS-232 and USB interface	23
5.2 Slot for interface cards	24
5.3 Emergency Power Off (EPO) function	24
5.4 Surge voltage protection for data and telephone lines (DSL / telephone / fax / network).....	25
5.5 DataWatch software	26
6. Maintenance	28
6.1 Care and maintenance	28
6.2 Storage.....	28
6.3 When to change the batteries	28
6.4 Replacing the batteries	29
6.5 Testing the new batteries	32
6.6 Disposing of the old batteries or UPS system.....	32
7. Troubleshooting.....	33
7.1 Error codes.....	33
7.2 Warnings	33
7.3 Troubleshooting.....	34
7.4 Muting the alarm.....	35
7.5 Support.....	35
8. Technical data	37

8.1	Specification	37
8.2	Rear view	39
8.3	CE confirmation.....	41
9.	Warranty.....	42

List of Illustrations

Figure 1:	Circuit diagram of principle	5
Figure 2:	ZINTO 800 - 3000 in the rack.....	6
Figure 3:	ZINTO 800 - 3000 as tower.....	6
Figure 4:	Removing the frontpanel	10
Figure 5:	Connecting the battery	10
Figure 6:	Foot mounting.....	10
Figure 7:	Installation as a tower.....	10
Figure 8:	Removing the frontpanel	11
Figure 9:	Turning the display	11
Figure 10:	Connect the battery	12
Figure 11:	Mounting the frontpanel.....	12
Figure 12:	Mounting the brackets	12
Figure 13:	Fitting in a rack	12
Figure 14:	Control panel and display.....	15
Figure 15:	Normal mode display.....	21
Figure 16:	Battery mode display.....	21
Figure 17:	Display in standby mode	22
Figure 18:	Display Buck & Boost mode display.....	22
Figure 19:	RS-232 interface (DB9-connector).....	23
Figure 20:	Emergency power off connector.....	25
Figure 21:	Removing the front panel	30
Figure 22:	Disconnecting the battery connector	31
Figure 23:	Removing the battery cover	31
Figure 24:	Rear view of ZINTO 800 - 1500	39
Figure 25:	Rear view of ZINTO 2000.....	39
Figure 26:	Rear view of ZINTO 3000.....	40

List of tables

Table 1: Package contents	9
Table 2: Descriptions of display	16
Table 3: Display	18
Table 4: Acoustic alarm	18
Table 5: Overview of operating status	19
Table 6: Configuration menu	20
Table 7: Pin assignment for RS-232 interface	23
Table 8: Interface cards	24
Table 9: Overview functions for LCD and DataWatch	27
Table 10: Error codes	33
Table 11: Warnings	34
Table 12: Troubleshooting	35
Table 13: Specification	38

1. Introduction

ONLINE USV-Systeme AG (ONLINE) is one of the leading manufacturers of uninterruptible power supplies (UPS). Since 1988, the German company has focussed on the development, production, sale and support of UPS systems. Based on unit numbers sold, ONLINE products are the German number one in the UPS market and internationally recognised because of their top quality and excellent support.

The power supply often fails when you least expect it. There can also be significant fluctuation in the quality of the power supply. Network problems can lead to the corruption of critical data, data which is not backed up can be lost and hardware damaged. This means expensive repairs and downtime.

Models in the ZINTO range from ONLINE are the best way of preparing for these kinds of scenarios. ZINTO protects sensitive applications from data loss and operating downtime, whether they are price-sensitive entry servers or high-end PCs, telephone systems, network peripherals or NAS boxes.

Two of the many highlights of the ZINTO range are its performance of up to 3000VA with silent operation and its design as a versatile rack tower system with just 2 height units.

The 'Buck & Boost' function offers additional security by electronically handling short power outages without using a battery. This increases the life expectancy of the battery and minimises ongoing costs.

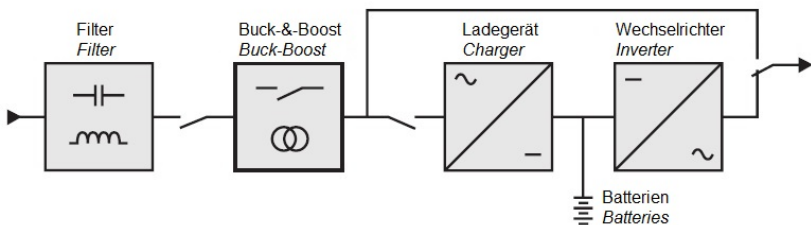

Figure 1: Circuit diagram of principle

The ZINTO also offers the following benefits:

- Rack-Tower-versatile model, only 2U
- Silent in normal operation
- Buck & Boost function for voltage regulation without battery
- Perfect sinewave output voltage
- Efficiency >97 %
- High active power due to Power factor 0.9
- Hot-swap battery for easy replacement while the system is running and without disconnect the load
- Battery deep discharge protection
- Cold-start function, starting the UPS system without main power
- Switchable output sockets to increase the backup time for critical loads
- Surge protection for data and telephone wires
- RS-232 and USB interface
- Slot for optional SNMP adapter or AS400-/dry-contact interface-card
- Emergency-off function (EPO = Emergency Power Off)
- 2 years warranty incl. battery and free exchange in advance



Figure 2: ZINTO 800 - 3000 in the rack



Figure 3: ZINTO 800 - 3000 as tower

2. Safety warnings

This manual contains important instructions that you must follow during the installation and maintenance of the UPS system and the batteries. Please read all the instructions in the manual before working with the device. Keep the manual in a safe place.



CAUTION

- The UPS system carries life-threatening voltages. All repair and maintenance work must be carried out by customer service personnel.
- The UPS system has its own energy source (batteries). The output of the UPS system can be live even when the UPS system is not connected to a source of alternating current.
- In order to reduce the risk of fire or electric shock, the UPS system may only be installed in buildings with controlled temperature and air humidity in which there are no conductive contaminants. The ambient temperature must not exceed 40°C. The UPS system must not be operated near water or in extremely high air humidity (>90%).
- Before transporting the UPS system, make sure that it is disconnected from the power supply and switched off.
- Batteries can pose a risk of electric shock or catch fire as a result of high short circuit current. Please take the necessary precautionary measures. Maintenance must be carried out by qualified personnel who are trained in handling batteries and have good knowledge of the necessary precautionary measures, see Chapter 6: *Maintenance*. Keep unauthorised personnel away from batteries
- Batteries must be disposed of properly. Local regulations must be taken into consideration.
- Batteries must not be burnt. There is risk of explosion.

3. Installation

3.1 Checking the delivery

Keep the transport box and the packaging material for the carrier or sales point. If parts of the system have been damaged in transit, submit a transport damage complaint to your supplier within 24 hours. If you only discover damage after accepting the device, please submit a complaint for concealed damage.

3.2 Unpacking the UPS system

	CAUTION
	<ul style="list-style-type: none">• Unpacking the UPS system at a low ambient temperature can lead to the formation of condensation inside and outside the casing. Only install the UPS system if the inside and outside are completely dry (risk of electric shock).• The UPS system is very heavy (see Chapter 8 <i>Technical Data</i>), be careful when unpacking and transporting it.

	PLEASE NOTE
	<p>Move and open the packaged UPS system carefully. Leave the components in their packaging until they are installed.</p>

To unpack the UPS system and accessories:

1. Open the external box and take the accessories packed with the UPS system out.
2. Carefully lift the UPS system out of the external box.
3. Place the UPS system in a protected, adequately ventilated position which is free of humidity, flammable gasses and corrosion.

3.3 Checking the accessories

Description	ZINTO 800	ZINTO 1000	ZINTO 1500	ZINTO 2000	ZINTO 3000
19" mounting bracket (left and right)	2	2	2	2	2
Feet for tower mounting (sets)	2	2	2	2	2
USB interface cable	1	1	1	1	1
10A IEC extension cable	2	3	3	4	4
16A mains cable				1	1
Quick start guide	1	1	1	1	1
DataWatch software*					
Manual*					

*Download from www.online-ups.com

Table 1: Package contents

3.4 Installation as tower, activating battery

The UPS system is delivered fully assembled.

	CAUTION
The casing is very heavy (see Chapter 8 <i>Technical Data</i>).	

1. For safety reasons, the UPS system is delivered without the batteries connected. In order to activate the battery, remove the front panel. To do this, pull them to the front side of the UPS system. Now connect the two red battery connectors to one another. Then fit the front panel again by reversing the sequence.

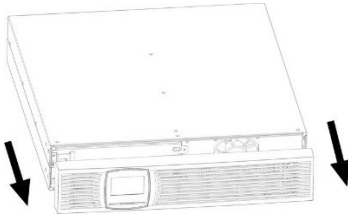

Figure 4: Removing the frontpanel

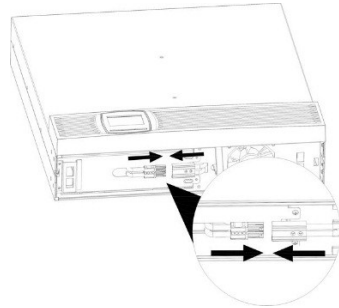

Figure 5: Connecting the battery

2. Connect two foot components to one foot (see Figure 6) and push the UPS system into the two feet from above (see Figure 7). Make sure the distance between the two feet is as great as possible to ensure stability.

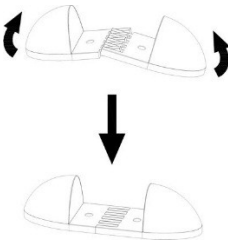

Figure 6: Foot mounting

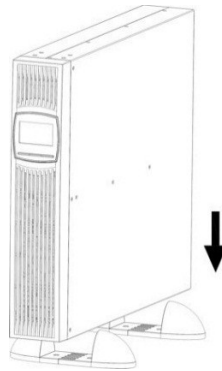



Figure 7: Installation as a tower

3. Continue the starting process (see Chapter 3.6 *Getting started*)

3.5 Installation in a rack, activating the batteries

The UPS system is delivered fully assembled.

	CAUTION
The casing is very heavy (see Chapter 8 <i>Technical Data</i>).	

Optional slide rails (article no. Rack Kit) are available for the rack model. The slide rails fit 48 cm (19 inch) racks with a depth of 48 to 78 cm.

1. Fit the rack kit (separate assembly instructions provided with the rack kit).
2. Adjust the display direction for horizontal rack installation. To do this, pull the frontpanel to the front side of the UPS system. Push the plastic clips apart and pull the display out of the holder. Push it 90 degrees anticlockwise and insert it back into the front panel.

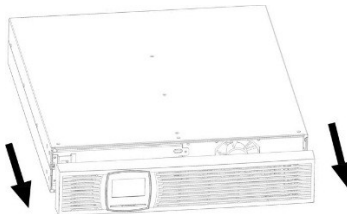

Figure 8: Removing the frontpanel

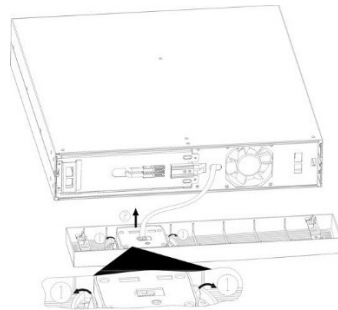

Figure 9: Turning the display

3. For safety reasons, the UPS system is delivered without the batteries connected. To activate the battery connect the two red battery connectors to one another.

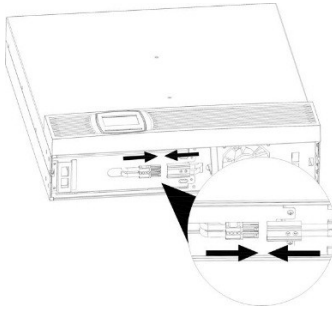

Figure 10: Connect the battery

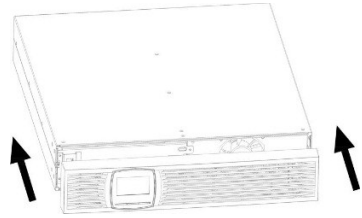

Figure 11: Mounting the frontpanel

4. Finally, fit the front panel by reversing the sequence.
5. Align the mounting bracket (L = left and R = right) with the screw holes on either side of the UPS system and affix it using the M4 x 8 countersunk screws provided.
6. Push the UPS system into the rack.
7. Secure the mounting bracket of the UPS system in the rack (see Figure 13).

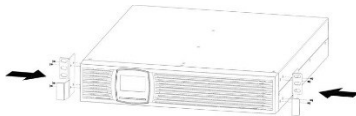

Figure 12: Mounting the brackets

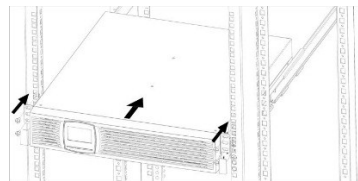

Figure 13: Fitting in a rack

8. Continue the getting started process (see Chapter 3.6)

3.6 Getting started



PLEASE NOTE

Make sure that the overall rated performance of the load connected does not exceed the capacity of the UPS system. The power consumption of inductive loads or laser printers can be very high, please take this into consideration when specifying your UPS system.

1. Connect the load with the UPS system without switching them on. Make sure that the UPS system has two groups of output sockets. The programmable output sockets can be switched independently of the remaining sockets. The programmable output sockets are primarily designed for less critical load which cannot be brought down using software. Critical load should not be connected to the programmable output sockets.
2. Connect the power supply cable (supplied with the ZINTO 2000 and 3000) for the UPS system into a socket. The display on the UPS system shows "Sb".
3. Hold the "ON / MUTE" button on the UPS system down until you hear a short beep.
4. The UPS system carries out a self-test, after which "OK" appears on the display. The UPS system is now operating in normal mode and supplying the load with reliable power.
5. If an additional emergency power off switch has been installed, the emergency stop function needs to be tested.
6. Switch the load on one by one.



PLEASE NOTE

The internal batteries charge up to 90% of their full capacity in less than six hours. ONLINE recommends charging the batteries for 48 hours after installation or extended periods of non-use.

The batteries start to charge as soon as the UPS system is connected to the supply network and supplied with power, irrespective of the operating mode.

Starting in battery mode

1. Hold the “ON / MUTE” button on the UPS system down until you hear a beep.
2. The UPS system is starting, the display then shows the battery statuses (see Chapter 4.4 *Operating statuses*) and supplies the load connected with reliable power.
3. If the display  lights up, resolve all warning messages (see Chapter 7.3. *Troubleshooting*) and restart the UPS system.

Switching off

1. Hold the “OFF” button on the UPS system down for 2 seconds.
When the continuous beep ends, the UPS system switches to standby mode.



PLEASE NOTE

If the “OFF” button is released after less than 2 seconds, the unit is not switched off.

2. Disconnect the mains connection cable of the UPS system from the socket. The display on the UPS system goes out after a short time and the UPS system switches off completely.



4. Operation

4.1 Control panel

The UPS system has a control panel with three buttons and a graphical display (see Figure 14).



Figure 14: Control panel and display













Button	Function	
ON /  / 	Switch on	In standby mode: Press button for more than 2 seconds
	Alarm signal OFF	In battery mode: Press button for more than 2 seconds, not valid if there are warning or error messages
	Back to top	In configuration mode: In previous menu
	Self-test	In normal mode: Press button for more than 2 seconds
OFF / 	Switch off	In normal mode: Press button for more than 2 seconds
	Selection	In configuration mode: Press the button to apply the selection

SELECT / ▼	Switch over	In normal mode: Switching the display from input voltage and frequency, battery voltage and capacity, UPS internal temperature, output voltage, frequency and current, load
	Configuration mode	In standby mode: Press button for longer than 2 seconds to start configuration mode
	Down	In configuration mode: Back to menu
ON + SELECT	Exit	In configuration mode: Press both buttons to revert from the sub-menu to the main menu or, if you are in the main menu, to exit configuration mode immediately.

Table 2: Descriptions of display

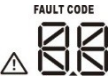
	PLEASE NOTE
<p>During the function or battery test, the batteries must be completely charged and the UPS system must be in normal mode.</p>	

4.2 Display and menu

Symbol	Description	Function
	Input, battery, temperature, output, load	Pressing the SELECT button in normal mode displays the following measurements: Input voltage and frequency, battery voltage and capacity, UPS internal temperature, output voltage, current and frequency, load in %.
	Autonomy time	Display of remaining autonomy time
	Load display	Displays the current load. Each segment represents 25%. If all the segments are lit up, the UPS system is working at 100% load.
	Overload	Indicates that the UPS system is overloaded
	Programmable output sockets	Indicates actively programmed output sockets
	Battery display	Indicates the current battery capacity. Each segment represents 25%. If all the segments are lit up, the battery is 100% charged.
	Battery empty	Battery symbol underneath battery display: Flashing indicates the battery capacity is almost empty
	Configuration	Display of configuration menu options. For further information, see Chapter 4.3 <i>Settings</i>
	Error	Display of error or alarm code For complete table, see Chapter 7.1 <i>Error codes</i>
	Acoustic alarm	Displays a deactivated acoustic alarm, silent
	Input voltage	The UPS input is connected to the mains voltage
	Rectifier	Rectifier active, battery charging
	Inverter	Active inverter, the load on the output sockets are UPS-protected





Symbol	Description	Function
	Output sockets	Active UPS output
	Battery	Battery symbol in DC link: UPS system in battery mode
	Battery charging	Battery symbol in DC link: Battery in charging mode
	Boost mode	The UPS system evens out low voltage in the mains voltage without the battery
	Buck mode	The UPS system evens out high voltage in the mains voltage without the battery

Table 3: Display

Alarm	Description
Every 5 seconds	UPS system in battery mode
Every 2 seconds	Battery voltage low
Every second	Overload
Continuous tone	Error

Table 4: Acoustic alarm

Abbreviation	Display	Description
AC	AC	Active Closed
AO	AO	Active Open
BL	bL	Battery Low
BR	bR	Battery Replace
CH	CH	Charger
DIS	dI 5	Disable
EE	EE	EEPROM Error
ESC	ESC	Escape

ENA	ENR	Enable
EP	EP	EPO / Emergency Power Off
ON	ON	On
OK	OK	OK
TP	TP	Temperature

Table 5: Overview of operating status

4.3 Settings

1. Open configuration menu: Switch to standby mode and press ▼ button for 3 seconds.
2. Selection of menu options: Press ▼ or ▲ button until you reach the menu option you want (see Table 6).
3. Select menu option: Press ← button.
4. Change menu setting: Press ▼ or ▲ button until you reach the setting you want (see Table 6).
5. Confirm setting: Press ← button.
6. Exiting configuration menu: go to menu "00" or press ▼ and ▲ buttons at the same time.







Setting	Available options	Standard
	Select output voltage: [208] = 208V [220] = 220V [230] = 230V [240] = 240V	"230V"
	Programmable output sockets: [ENA] = Enabled [DIS] = Disabled	"DIS"
	Shutdown time for programmable output sockets: [0 - 999] = Shutdown of programmable output sockets in battery mode after time defined here. Only available if "Programmable output sockets = active" and UPS system re-started after setting the time.	"999"
	Battery deep discharge protection: Shutdown of all output sockets in battery mode after time defined here. [0 - 999] = Shutdown after 0 to 999 minutes. [DIS] = Shutdown time dependent on battery capacity. Attention: If the setting is [0], shutdown is after 10 seconds.	"DIS"
	Emergency power off function: [AO] = active open, emergency power off is active with emergency power off contact open [AC] = active close, emergency power off is active with emergency power off contact closed	"AO"
	Exit: Exiting configuration menu	

Table 6: Configuration menu

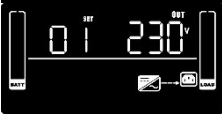
4.4 Operating statuses

The status of the UPS system is displayed on the control panel.

Normal operating mode

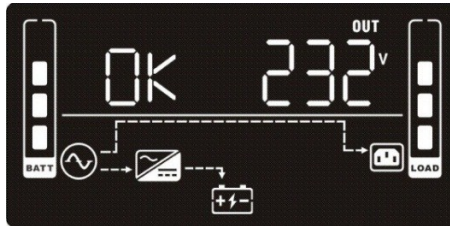

Figure 15: Normal mode display

In normal mode, “OK” is shown on the display and the UPS system is fed by the supply network. The UPS system monitors the batteries and charges them as required. The load connected is supplied with power.

Battery mode

In battery mode, the following display appears:



Figure 16: Battery mode display

At the same time, an acoustic alarm every 5 seconds indicates that the load connected is being supplied with battery power.

If the battery charge is low in battery mode, the display shows “BL”,  starts flashing and the alarm sounds every 2 seconds. The remaining autonomy time is low. Close all applications, as the UPS is about to shut down automatically.

If the battery is exhausted, the UPS system shuts itself down. All displays and the alarm are switched off.

If the supply network is restored after the UPS system has shut down, the UPS is automatically restarted. The batteries are charged up and the load connected are supplied with power.

Standby mode

If the UPS system is switched off and the power supply cable is connected, the UPS system works in standby mode. The following display appears:



Figure 17: Display in standby mode

No power is available for the load connected. The battery is charged if necessary.

Buck & Boost mode

If the input voltage is greater than the maximum tolerance, the UPS system switches into buck mode. The output voltage is reduced to a non-critical level electronically, without using the batteries.

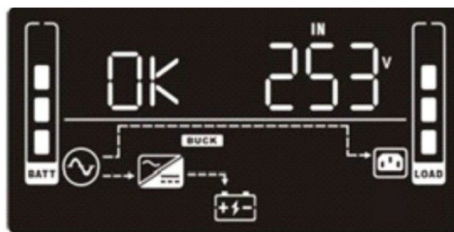

Figure 18: Display Buck & Boost mode display

Boost mode evens out insufficient input voltage electronically, without using the battery. The output voltage is raised to a non-critical level for the load connected.

5. Communication and interfaces

5.1 RS-232 and USB interface

In order to establish communication between the UPS system and a computer, connect the computer using a suitable data cable (USB cable provided) to the RS-232 or USB interface on the UPS system (see Chapter 8.2 *Rear view*).

	PLEASE NOTE
The RS-232 and USB communication interfaces cannot be used at the same time.	

The UPS system can then exchange data via the DataWatch software (see Chapter 5.5).

The assignment of the cable connection pins for the RS-232 communications interface is shown in Figure 19, while the functions of the connection pins can be found in Table 7.

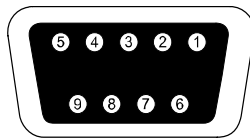

Figure 19: RS-232 interface (DB9-connector)

Pin	Function
1	Not used
2	Send data (TxD)
3	Receive data (RxD)
4	Not used
5	Mass
6, 7, 8, 9	Not used

Table 7: Pin assignment for RS-232 interface

5.2 Slot for interface cards

The ZINTO features a slot (see Chapter 8.2 *Rear view*) for the following interface cards:

Product no.	Description
DW7SNMP30	SNMP adapter Basic The SNMP adapter communicates via TCIP/IP with the load attached to the network.
DW5SNMP30	SNMP adapter Professional Works like <i>Basic</i> , but with additional interface for temperature sensor and building management.
DWAS400DC	AS400 relay card Combined slot card for optional communication with IBM AS400 servers or individual use of relay contacts. The following messages/contact outputs are available: UPS normal mode, standby mode, battery mode, battery voltage low, bypass mode (XANTO only), aggregated error, input for UPS shutdown.

Table 8: Interface cards



PLEASE NOTE

The interface cards installed in the slot can be used in parallel with the RS-232 or USB communication.

5.3 Emergency Power Off (EPO) function

The Emergency Power Off (EPO) function is used to remotely shut down the UPS system and connected load immediately. This means removing the bridge on the emergency power off connector (back of UPS system, see Chapter 8.2 *Rear view*) and connecting an external emergency power off switch.

Cross section of connecting cable = 0.5 - 2.5mm² (AWG 13 - 20)

Recommended cross-section of connecting cable = 1.5mm² (AWG 15)

	CAUTION
<ul style="list-style-type: none"> • The emergency power off switch must not be connected to circuits which are connected to the supply network. Reinforced insulation from the network is required. The emergency power off switch must be designed for at least 60V DC / 30V AC and 20mA. • Depending on the programming via the UPS menu (see Chapter 4.3), either an opener or a closer can be used. The emergency power off function must be active for at least 250ms for proper operation. • If the emergency power off function is activated, the input voltage of the UPS system also needs to be interrupted. • The emergency power off function is only used to shut down the UPS voltage on an electronic basis. 	

	PLEASE NOTE
<ul style="list-style-type: none"> • Leave the plug of the UPS system connected if you do not need the emergency power off function. • Always test the emergency power off function before connecting a critical load. This avoids the load being switched off accidentally 	

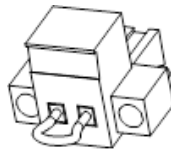

Figure 20: Emergency power off connector

See Chapter 8.2 *Rear view* for the position of the emergency power off connector.

5.4 Surge voltage protection for data and telephone lines (DSL / telephone / fax / network)

The surge protection filters surge voltage from the data and telephone cables. This involves connecting the incoming cable to the IN connection on the reverse of the UPS system. Connect the OUT connection

to the end device. The data connection protection cable protects networks with a transfer rate of 10 to 1000 Mbit/s.

5.5 DataWatch software

The ZINTO range is supplied as standard with DataWatch, a comprehensive software solution for shutting down and managing the PC or server system and for monitoring the ZINTO and the power supply network. To ensure you are always working with the latest version of DataWatch, please download it from the download area of www.online-usv.de.

DataWatch works in the background and is in constant communication with the ZINTO via the RS-232, USB or network protocol. The most famous of all functions: Automatic data backup including the shutdown of running applications and the proper shutdown of the whole system by means of a freely configurable shutdown routine. At the same time, DataWatch has a comprehensive messaging system, time-controlled test routines and event logging.

DataWatch supports all current operating systems.

As a client/server application, DataWatch works in networks and on local workstations. Based on optional RCCMD agent (Remote Console Command), multiple servers connected to a UPS system can be addressed and controlled across the network without additional hardware.

Overview of functions:

	UPS / LCD	DataWatch software
Display of input voltage, frequency and current, battery voltage, current and capacity, UPS internal temperature, output voltage, frequency and current, load	X	X
Change operation mode of the UPS system (normal mode, standby mode)	X	X
Changing the output voltage	X	X
Configure and enable/disable the programmable outlet sockets	X	X
Configure and enable/disable the battery deep discharge protection	X	X

Configure and enable/disable the emergency power off function (EPO)	X	X
Manual restart of the UPS system	X	X
Signalling battery failure	X	X
Advanced display of the total battery runtime		X
Display of the serial number		X
Local server shutdown via RS-232 / USB-interface		X
Multi server shutdown via TCP/IP		X
SNMP-proxy-agent		X
Send E-Mail, SMS, broadcastmessages		X
Manual UPS 10s-test	X	X
Manual UPS fulltest		X
Auto UPS selftest		X
Enable/disable alarm for battery operation	X	X
Enable/disable all alarms		X
Reset UPS system to factory settings		X
Display alarm-, warning- and error-messages	X	X
Chronological record, display and export (csv) of warning-, alarm- and error-messages		X
Record, display and export (csv) of voltage, current, frequency and temperature (datalog chart)		X
Customized event configuration		X

Table 9: Overview functions for LCD and DataWatch

6. Maintenance

6.1 Care and maintenance

To ensure a long service life for the system, the area around the UPS system should be kept clean and free of dust. If the area around the system is very dusty, clean the external surfaces of the system with a vacuum cleaner.

To ensure a long service life for the batteries, the ambient temperature should not exceed 25°C.

	PLEASE NOTE
<ul style="list-style-type: none">• Before transporting the UPS system, make sure that it is disconnected from the supply network and switched off.• The service life of a battery varies as a function of how often it is used, intensity of use and ambient temperature. Batteries which are used beyond their expected service life often have reduced autonomy times. Replace the batteries in good time to ensure the system always runs at optimum performance.	

6.2 Storage

If you intend to store the UPS system for an extended period, charge the battery every three months by connecting the UPS system to the supply network for five hours. The system should be stored in a cool, dry place.

6.3 When to change the batteries

If “BR” is shown on the display and an alarm signal sounds every 2 seconds, the batteries need to be replaced. Contact your reseller or ONLINE (www.usvshop24.de) to order new batteries.

6.4 Replacing the batteries



PLEASE NOTE

Do not replace the batteries while the UPS system is in battery mode.

The hot-swap functionality means the batteries can be replaced without first shutting down the UPS system and disconnecting the load.

If you would prefer to disconnect the UPS system before changing the batteries, read Chapter 3.6 *Getting started*.



CAUTION

- Maintenance work must be carried out by a qualified technician who is familiar with batteries and the necessary safety measures. Do not allow unauthorised personnel to handle the batteries.
- Batteries pose the risk of an electric shock or injury due to high short circuit current. Take the following safety measures:
 - remove watches, jewellery and other metal items
 - only use tools with insulated handles
 - do not place tools or metal components on the batteries
- The batteries must only be replaced with the same number of batteries of the same type.
- Batteries must be properly disposed of. When disposing of batteries, comply with the statutory regulations applicable in your location.
- Batteries must not be burnt. There is risk of explosion.
- Do not open or damage the battery or batteries. Battery acid can damage the eyes and skin and cause poisoning.

	CAUTION
<ul style="list-style-type: none">• DANGER OF ELECTRIC SHOCK. Never make changes to the battery cabling or connections. Attempting to change the battery cabling yourself could lead to serious injury.• The batteries of the UPS system are very heavy. Be careful when handling heavy batteries.	

The batteries are behind the front panel of the UPS system. The internal batteries are packed together for ease of handling.

1. Remove the front panel (see Figure 21). To do this, pull the frontpanel to the front side of the UPS system.

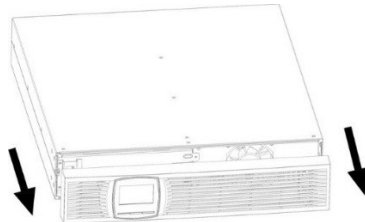



Figure 21: Removing the front panel

	PLEASE NOTE
<p>There is a flat ribbon cable connecting the control panel to the UPS system. Do not pull on the cable or disconnect it.</p>	

2. Disconnect the battery connector (see Figure 22)

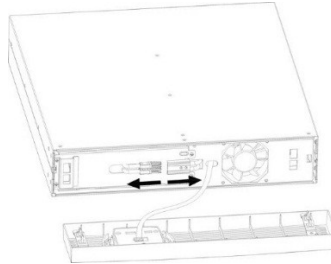

Figure 22: Disconnecting the battery connector

3. Remove the battery cover (see Figure 23).

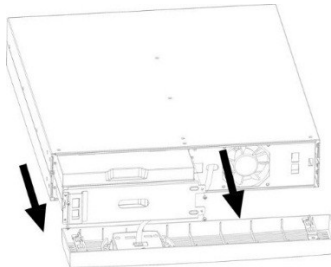

Figure 23: Removing the battery cover

4. Carefully remove the battery insert using the handle.
5. Replace the batteries in the battery insert.



PLEASE NOTE

- Check that the replacement batteries have the same specifications as the old batteries.
- Read Chapter 6.6 *Disposing of the old batteries or UPS system* for information on proper disposal.



6. Reverse the removal procedure to reinsert the battery insert.

**CAUTION**

A small arc can occur when the batteries are connected to the UPS system. This is normal and represents no risk to personnel. Insert the battery cable quickly and firmly into the battery plug connection in the UPS system.

7. Continue with Chapter 6.5.

6.5 Testing the new batteries

1. To charge the batteries, connect the UPS to the supply network for 48 hours.
2. In normal mode, hold the ON /  /  button for at least 2 seconds to start the self-test.
3. If the batteries are faulty, a warning is displayed automatically (see Table 11: *Warnings*). Press “OK” to acknowledge a successful battery test and to switch the UPS system back into normal mode.

**PLEASE NOTE**

The UPS system only starts a self-test when the batteries are fully charged and the UPS system is in normal mode with no active warning messages.

6.6 Disposing of the old batteries or UPS system

Find out from a local recycling centre how the old batteries or the UPS system should properly be disposed of. Old batteries can also be returned to ONLINE for disposal free of charge. Please contact Support (see Chapter 0)

**CAUTION**

- Batteries must not be burnt. There is risk of explosion.
- Batteries must be disposed of properly. Find out about the local disposal regulations.
- Do not open or damage the battery or batteries. Battery acid can damage the eyes and skin and cause poisoning.

7. Troubleshooting

The ZINTO is designed for autonomous operation and automatically reports and problems in the display.







7.1 Error codes

Error code	Event
01	Error starting the DC link
02	DC link voltage too high
03	DC link voltage too low
11	Error starting inverter
12	Inverter voltage too high
13	Inverter voltage too low
14	Short circuit in inverter output
27	Battery voltage too high
28	Battery voltage too low
41	Temperature too high
43	Overload
45	Charger error

Table 10: Error codes

If the UPS system indicates one of the error codes listed above, please contact ONLINE support (see Chapter 7.5).









7.2 Warnings

Event	Symbol	Code	Alarm
Battery capacity low		bl	Warning sound every 2 seconds
Overload		OL	Warning sound every second
Battery not connected		nc	Warning sound every 2 seconds
Battery overload		OC	Warning sound every 2 seconds
Emergency power off active		EP	Warning sound every 2 seconds
Temperature too high		EP	Warning sound every 2 seconds

Charger error			Warning sound every 2 seconds
Battery error			Warning sound every 2 seconds
Replace battery			Warning sound every 2 seconds
EEPROM Error			Warning sound every 2 seconds

Table 11: Warnings



7.3 Troubleshooting

Operating status	Possible cause	Measure
The UPS system cannot be switched on, although there are no alarms and the input voltage is normal.	<p>The input cable is not correctly connected to the input socket.</p> <p>The input cable has been accidentally connected to the UPS output sockets.</p>	<p>Check that both connectors are properly inserted in the sockets.</p> <p>Connect the input cable to the UPS input.</p>
The  and  symbols flash and an alarm is sounded every 2 seconds.	Emergency power off is active.	Check that the emergency power off connector is seated firmly and the wire jumpers match the menu settings in Chapter 4.3 (closed or open, depending on the jumper). Then press the OFF button for 2 seconds and start the UPS system using the ON button.
The  ,  and  symbols flash and an alarm is sounded every 2 seconds.	The internal battery is not connected.	Check that the battery is properly connected (see Chapter 3.4, 3.5). Then restart the UPS system using the ON button.
The  ,  and  symbols flash and an alarm is sounded every second.	The output load on the UPS system is too high.	Reduce the load on the UPS output sockets.
The  symbol and error code 43 are shown on the display and a continuous alarm sounds.	UPS system shutting down because of too frequent or too extensive overload on the UPS output.	Reduce the load on the UPS output sockets. Then press the OFF button for 2 seconds. Then restart the UPS system using the ON button.

Error code 14 and continuous alarm.	Short circuit in UPS output.	Disconnect all the load from the UPS output sockets and restart the UPS system without load. If the error continues to occur, please contact ONLINE support (see Chapter 7.5). If the error has been fixed, check the load.
Autonomy time is shorter than expected.	Battery is not fully charged.	Charge the battery for at least 5 hours. If the error persists, please contact ONLINE support (see Chapter 7.5).
	The battery is worn through age or faulty.	Replace the battery (see Chapter 6.4).

Table 12: Troubleshooting

7.4 Muting the alarm

In battery mode, hold the ON /  /  button for at least 2 seconds to mute the alarm. Once the alarm is successfully muted,  appears in the display. Check the status the warning message has triggered and take appropriate measures to rectify the situation. If the status of the warning message changes, the alarm is emitted again. This has priority over the previous muting of the alarm.



PLEASE NOTE

The alarm cannot be muted for alarm and error messages.

7.5 Support

ONLINE USV-Systeme AG (ONLINE) is one of the leading manufacturers of uninterruptible power supplies (UPS). Since 1988, the German company has focussed on the development, production, sale and support of UPS systems. Based on unit numbers sold, ONLINE products are the German number one in the UPS market and internationally recognised because of their top quality and excellent support.

As a German provider, ONLINE guarantees direct approachability, simple processing and short response times. Comprehensive support is a matter of course - before and after purchase.

ONLINE sets great store by reliable support and service.

- Free direct advice and support on:
 - Software hotline: +49 (89) 242 39 90 - 13
 - Hardware hotline: +49 (89) 242 39 90 - 18
- Free 24 h advance exchange
- Interactive UPS configurator online or as app
- 2 years full warranty, optional renewal
- Unbureaucratic 14 day money-back guarantee
- Excellent product availability and wide network of distributors.

Further information: www.online-usv.de

8. Technical data

8.1 Specification

Model	ZINTO 800	ZINTO 1000	ZINTO 1500	ZINTO 2000	ZINTO 3000
Product no.	Z800	Z1000	Z1500	Z2000	Z3000
Electrical characteristics					
Rated power (VA / W)	800 / 720	1000 / 900	1500 / 1350	2000 / 1800	3000 / 2700
Technology	Line interactive technology with sine output voltage and Buck&Boost function.				
Input voltage and tolerance normal operation	230V (162 – 290V)				
Frequency	50 / 60Hz (auto sensing) +/-5Hz				
Input current	6.0A	7.4A	11.0A	14.9A	17.6A
Output voltage	230V (adjustable to 208 / 220 / 230 / 240V)				
Output voltage tolerance battery operation	+/-3%				
Output frequency normal operation	50 / 60Hz +/-1Hz				
Power loss, max.	88W	110W	165W	220W	330W
Output current, max.	4.2A	5.3A	7.9A	10.6A	15.9A
Switchover time	Type 2 – 6ms				
Wave form	Sine				
Efficiency, Normal operation	97%				
Buck & Boost mode	95%				
Battery mode	89%		91%		92%
Overload-compatible, normal mode					
<120%	Alarm, standby mode after 5 minutes				
120 – 150%	Alarm, standby mode after 10 seconds				
>150%	Alarm, standby mode after 1 second				
Battery mode					
<120%	Alarm, standby mode after 1 minute				
120 – 150%	Alarm, standby mode after 10 seconds				
>150%	Alarm, standby mode after 0.5 seconds				

Connections					
Input	1x IEC320 C14 (10A)			1x IEC320 C20 (16A)	
Outputs, 10A	8x IEC320 C13 (10A)				
Output, 16A					1x IEC320 C19 (16A)
Batteries					
Type Autonomy times at 50 and 100% load and pf=0.7	14 / 6	19 / 7	23 / 10	17 / 6	17 / 6
Battery type	2x 12V / 7Ah	2x 12V / 12Ah	4x 12V / 9Ah	4x 12V / 9Ah	6x 12V / 9Ah
Design	Sealed, maintenance-free, valve-controlled, lead/acid, life expectancy 3 to 5 years in accordance with EUROBAT				
Charging current	1.5A				
Charging time	<6 hours to 90%				
Communication					
USB	Yes				
RS-232:	Yes				
Modem / Network	Yes				
Over-voltage protection	Yes				
SNMP slot	Yes				
EPO	Yes				
Operating conditions, standards and approvals					
Operating temperature	0 – 40°C				
Rel. air humidity	0 – 90%				
Noise level Normal mode / max (dBA)	Silent / <45 dB				
MTBF at 25°C (w/o battery)	>50.000 hours				
Safety	EN62040-1				
EMC, Performance	EN62040-2 (EN61000-2-2, EN61000-3-2, EN61000-4-2, EN61000-4-3, EN61000-4-4, EN61000-4-5, EN61000-4-6, EN61000-4-8)				
Approval	CE				
Protection class	IP20				
Dimensions / Weight					
Dimensions (W x H x D)	438 x 88 (2U) x 412	438 x 88 (2U) x 412	438 x 88 (2U) x 512	438 x 88 (2U) x 512	438 x 88 (2U) x 632
Weight	12.9kg	14.5kg	21kg	21.5kg	29.3kg

Table 13: Specification

8.2 Rear view

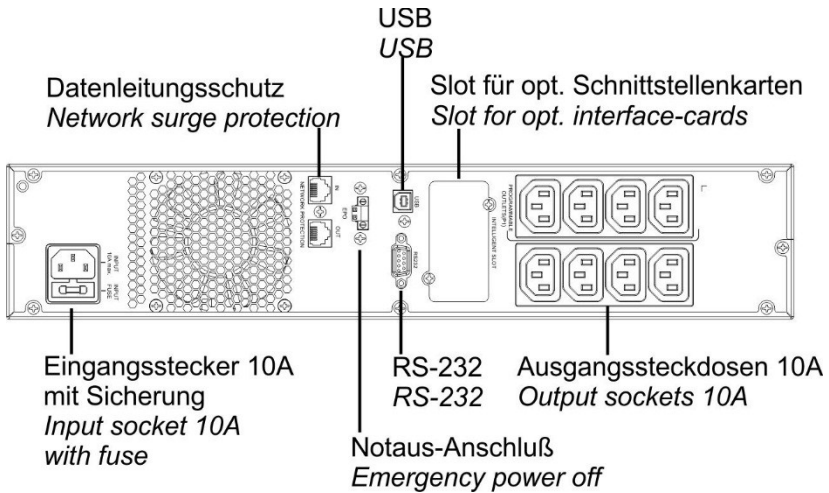

Figure 24: Rear view of ZINTO 800 - 1500

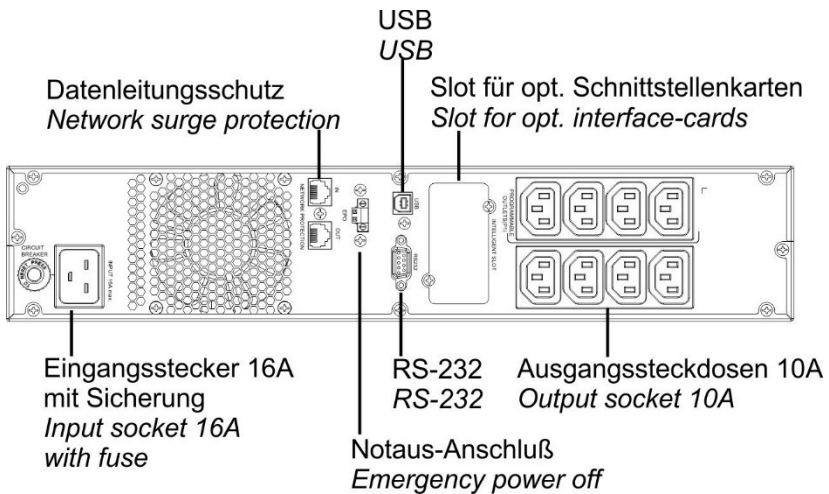

Figure 25: Rear view of ZINTO 2000

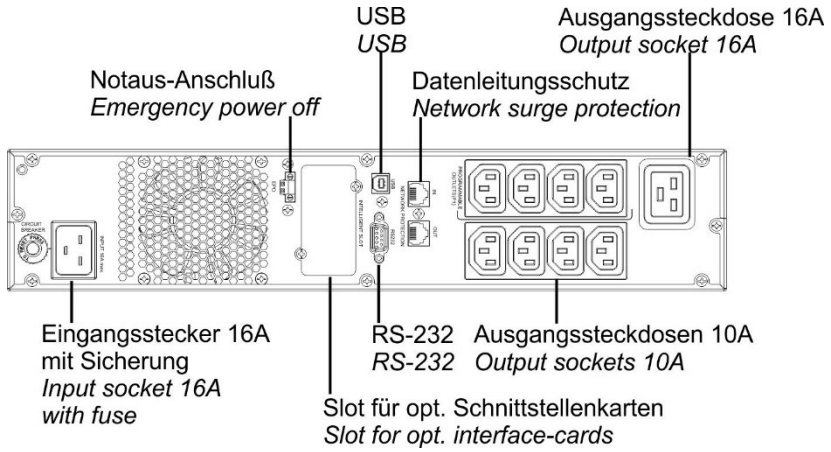

Figure 26: Rear view of ZINTO 3000

8.3 CE confirmation

Online
 USV-Systeme AG
 Luise-Ullrich-Str. 8
 D-82031 Grünwald/Germany
 Telefon +49(0)89/2423990-10
 Telefax +49(0)89/2423990-20



DECLARATION of CONFORMITY

Herewith we confirm,
 ONLINE USV-Systeme AG, Luise-Ullrich-Str. 8, 82031 Grünwald / Germany,
 that

Product: Uninterruptible Power Supply
 Typ: **ZINTO 800 (Art.-Nr. Z800),
 ZINTO 1000 (Art.-Nr. Z1000),
 ZINTO 1500 (Art.-Nr. Z1500),
 ZINTO 2000 (Art.-Nr. Z2000),
 ZINTO 3000 (Art.-Nr. Z3000)**

corresponds to the provisions of following directives:
 - 2014 / 35 / EU (Low voltage directive)
 - 2014 / 30 / EU (EMC directive)

For the evaluation of the compliance with these directives, the following standards and specifications were applied:

Low voltage directive: EN62040-1: 2008 + A1: 2013
 EMC directive: EN62040-2: 2006 + AC: 2006
 EN61000-3-2: 2014 (EN61000-4-2: 2009, EN61000-4-3: 2006 + A2:
 2010, EN61000-4-4: 2012, EN61000-4-5: 2006, EN61000-4-6: 2014, EN
 61000-4-8: 2010, EN 61000-2-2: 2002)

Name: Sven O. Spitzley
 Position / Titel: Vorstand, Dipl.-Ing. (FH)

Grünwald, 14. March 2017

Bankverbindung:
 VR-Bank
 Landsberg-Ammersee eG
 BLZ 700 916 00
 Kto.-Nr. 5 267 110

BIC: GENODEF1DSS
 IBAN: DE09 7009 1600
 0005 267110

Vorstand:
 Hans Setzle (Vorsitzender)
 Sven Spitzley
 Aufsichtsratsvorsitzender:
 André Kollmuß

Amtsgericht München
 HRB 138051

Ust-Id-Nr./VAT REG.No.
 DE 128672915

V2800-3000_CE-Deklaration_20170314.docx

9. Warranty

ONLINE USV-Systeme AG (ONLINE) guarantees that this product will be free of material and production faults for a period of two years from the purchase date. ONLINE's obligation in accordance with this guarantee is restricted to the repair or replacement (at ONLINE's discretion) of any faulty products. Before warranty claims can be asserted, a Returned Material Authorization (RMA) number must be obtained from customer services. Products must be returned with the postage paid by the sender, a brief description of the problem and evidence of the place and date of purchase. This warranty does not apply to devices damaged by accidents, negligence or misuse or those which have otherwise been altered or modified.

Apart from the above exceptions, ONLINE accepts no explicit or tacit warranty, including a guarantee of conventional quality or suitability for a specific purpose. In some jurisdictions, the restriction or exclusion of tacit guarantees is prohibited, which means that the restrictions or exclusions above may not apply to the purchaser.

Irrespective of the above exclusions, ONLINE shall under no circumstances accept liability for direct, indirect, specific, auxiliary or subsequent damage caused as a result of the use of this product, even if ONLINE was informed about the possibility of such damage. In particular, ONLINE shall not be liable for costs of whatsoever nature, such as lost profit or revenue, loss of equipment, loss of the use of device, loss of software or data, replacement costs, third-party claims or other costs.

The content is copyright © 2017 by ONLINE USV-Systeme AG. All rights reserved. Unauthorised reproduction in part or in whole is not permitted without consent.