



X11DPL-I

USER'S MANUAL

Revision 1.0a

The information in this User's Manual has been carefully reviewed and is believed to be accurate. The vendor assumes no responsibility for any inaccuracies that may be contained in this document, and makes no commitment to update or to keep current the information in this manual, or to notify any person or organization of the updates. **Please Note: For the most up-to-date version of this manual, please see our website at www.supermicro.com.**

Super Micro Computer, Inc. ("Supermicro") reserves the right to make changes to the product described in this manual at any time and without notice. This product, including software and documentation, is the property of Supermicro and/or its licensors, and is supplied only under a license. Any use or reproduction of this product is not allowed, except as expressly permitted by the terms of said license.

IN NO EVENT WILL Super Micro Computer, Inc. BE LIABLE FOR DIRECT, INDIRECT, SPECIAL, INCIDENTAL, SPECULATIVE OR CONSEQUENTIAL DAMAGES ARISING FROM THE USE OR INABILITY TO USE THIS PRODUCT OR DOCUMENTATION, EVEN IF ADVISED OF THE POSSIBILITY OF SUCH DAMAGES. IN PARTICULAR, SUPER MICRO COMPUTER, INC. SHALL NOT HAVE LIABILITY FOR ANY HARDWARE, SOFTWARE, OR DATA STORED OR USED WITH THE PRODUCT, INCLUDING THE COSTS OF REPAIRING, REPLACING, INTEGRATING, INSTALLING OR RECOVERING SUCH HARDWARE, SOFTWARE, OR DATA.

Any disputes arising between manufacturer and customer shall be governed by the laws of Santa Clara County in the State of California, USA. The State of California, County of Santa Clara shall be the exclusive venue for the resolution of any such disputes. Supermicro's total liability for all claims will not exceed the price paid for the hardware product.

FCC Statement: This equipment has been tested and found to comply with the limits for a Class A digital device pursuant to Part 15 of the FCC Rules. These limits are designed to provide reasonable protection against harmful interference when the equipment is operated in a commercial environment. This equipment generates, uses, and can radiate radio frequency energy and, if not installed and used in accordance with the manufacturer's instruction manual, may cause harmful interference with radio communications. Operation of this equipment in a residential area is likely to cause harmful interference, in which case you will be required to correct the interference at your own expense.

California Best Management Practices Regulations for Perchlorate Materials: This Perchlorate warning applies only to products containing CR (Manganese Dioxide) Lithium coin cells. "Perchlorate Material-special handling may apply. See www.dtsc.ca.gov/hazardouswaste/perchlorate".

WARNING: Handling of lead solder materials used in this product may expose you to lead, a chemical known to the State of California to cause birth defects and other reproductive harm.

The products sold by Supermicro are not intended for and will not be used in life support systems, medical equipment, nuclear facilities or systems, aircraft, aircraft devices, aircraft/emergency communication devices or other critical systems whose failure to perform be reasonably expected to result in significant injury or loss of life or catastrophic property damage. Accordingly, Supermicro disclaims any and all liability, and should buyer use or sell such products for use in such ultra-hazardous applications, it does so entirely at its own risk. Furthermore, buyer agrees to fully indemnify, defend and hold Supermicro harmless for and against any and all claims, demands, actions, litigation, and proceedings of any kind arising out of or related to such ultra-hazardous use or sale.

Manual Revision 1.0a

Release Date: November 16, 2017

Unless you request and receive written permission from Super Micro Computer, Inc., you may not copy any part of this document. Information in this document is subject to change without notice. Other products and companies referred to herein are trademarks or registered trademarks of their respective companies or mark holders.

Copyright © 2017 by Super Micro Computer, Inc.
All rights reserved.

Printed in the United States of America

Preface

About This Manual

This manual is written for system integrators, IT technicians, and knowledgeable end users. It provides information for the installation and use of the X11DPL-i motherboard.

About This Motherboard

The X11DPL-i motherboard supports dual Intel Xeon 81xx/61xx/51xx/41xx/31xx series processors (Socket P) with a TDP (Thermal Design Power) of up to 140W and a UPI (UltraPath Interconnect) of up to 10.4GT/s. Built with the Intel® C621 PCH, this motherboard supports up to 1TB of 3DS LRDIMM/LRDIMM/RDIMM/NV-DIMM DDR4 ECC 2666/2400/2133 MHz memory in 8 memory slots. It offers support for Intel Intelligent Power Node Manager, Active Management Technology, and vPro technology. The X11DPL-i includes ten SATA 3.0 ports, one M.2 slot, and dual LAN and USB 2.0 and 3.0 ports. The X11DPL-i provides maximum performance, cost effectiveness, PCI-E capacity, and I/O flexibility. This motherboard is optimized for PCI-Express expansion with flexible IO support, and is ideal for high-performance server platforms. Please note that this motherboard is intended to be installed and serviced by professional technicians only. For processor/memory updates, please refer to our website at <http://www.supermicro.com/products/>.

Manual organization

Chapter 1 describes the features, specifications and performance of the motherboard, and provides detailed information on the Intel C621 chipset.

Chapter 2 provides hardware installation instructions. Read this chapter when installing the processor, memory modules and other hardware components into the system.

If you encounter any problems, see **Chapter 3**, which describes troubleshooting procedures for video, memory and system setup stored in the CMOS.

Chapter 4 includes an introduction to the BIOS, and provides detailed information on running the CMOS Setup utility.

Appendix A provides BIOS Error Beep Codes.

Appendix B lists software program installation instructions.

Appendix C lists standardized warning statements in various languages.

Appendix D contains UEFI BIOS Recovery instructions.

Contacting Supermicro

Headquarters

Address: Super Micro Computer, Inc.
980 Rock Ave.
San Jose, CA 95131 U.S.A.

Tel: +1 (408) 503-8000

Fax: +1 (408) 503-8008

Email: marketing@supermicro.com (General Information)
support@supermicro.com (Technical Support)

Website: www.supermicro.com

Europe

Address: Super Micro Computer B.V.
Het Sterrenbeeld 28, 5215 ML
's-Hertogenbosch, The Netherlands

Tel: +31 (0) 73-6400390

Fax: +31 (0) 73-6416525

Email: sales@supermicro.nl (General Information)
support@supermicro.nl (Technical Support)
rma@supermicro.nl (Customer Support)

Website: www.supermicro.nl

Asia-Pacific

Address: Super Micro Computer, Inc.
3F, No. 150, Jian 1st Rd.
Zhonghe Dist., New Taipei City 235
Taiwan (R.O.C)

Tel: +886-(2) 8226-3990

Fax: +886-(2) 8226-3992

Email: support@supermicro.com.tw

Website: www.supermicro.com.tw

Table of Contents

Chapter 1 Introduction

1.1 Checklist	8
Quick Reference	11
Quick Reference Table	12
Motherboard Features	13
1.2 Processor and Chipset Overview	17
1.3 Special Features	17
Recovery from AC Power Loss	17
1.4 System Health Monitoring	18
Onboard Voltage Monitors	18
Fan Status Monitor with Firmware Control	18
Environmental Temperature Control	18
System Resource Alert	18
1.5 ACPI Features	19
1.6 Power Supply	19
1.7 Super I/O	19
1.8 Advanced Power Management	20
Management Engine (ME)	20

Chapter 2 Installation

2.1 Static-Sensitive Devices	21
Precautions	21
Unpacking	21
2.2 Motherboard Installation	22
Tools Needed	22
Location of Mounting Holes	22
Installing the Motherboard	23
2.3 Processor and Heatsink Installation	24
The Processor	24
Overview of the Processor Socket Assembly	25
Overview of the Processor Heatsink Module	26
Preparing the CPU Socket for Installation	27

Removing the Dust Cover from the CPU Socket	27
Attaching the Processor to the CPU/Heatsink Carrier.....	28
Attaching the CPU/Carrier Assembly to the Passive Heatsink to Form the Processor Heatsink Module (PHM).....	29
Installing the Processor Heatsink Module (PHM)	30
Removing the Processor Heatsink Module (PHM).....	31
2.4 Memory Support and Installation	32
Memory Support.....	32
DIMM Population Requirements for the 81xx/61xx/51xx/41xx/31xx Processors	33
DIMM Installation	34
DIMM Removal	34
2.5 Rear I/O Ports	35
2.6 Front Control Panel.....	39
Power Connector	44
2.7 Connectors	44
Headers.....	46
2.8 Jumper Settings	53
How Jumpers Work.....	53
2.9 LED Indicators.....	57
2.10 PCI-E 3.0 Slots	60
Chapter 3 Troubleshooting	
3.1 Troubleshooting Procedures	61
Before Power On	61
No Power	61
No Video	62
System Boot Failure	62
Memory Errors	62
Losing the System's Setup Configuration.....	63
When the System Becomes Unstable	63
3.2 Technical Support Procedures	65
3.3 Frequently Asked Questions	66
3.4 Battery Removal and Installation	67
Battery Removal.....	67

Proper Battery Disposal	67
Battery Installation.....	67
3.5 Returning Merchandise for Service.....	68
Chapter 4 BIOS	
4.1 Introduction.....	69
4.2 Main Setup	70
4.3 Advanced Setup Configurations.....	72
4.4 Event Logs	101
4.5 IPMI	103
4.7 Boot	109
4.8 Save & Exit	111
Appendix A BIOS Codes	
Appendix B Software Installation	
B.1 Installing Software Programs	115
B.2 SuperDoctor® 5.....	116
Appendix C Standardized Warnings	
Battery Handling.....	117
Product Disposal	119
Appendix D UEFI BIOS Recovery	

Chapter 1

Introduction

Congratulations on purchasing your computer motherboard from an industry leader. Supermicro motherboards are designed to provide you with the highest standards in quality and performance.

In addition to the motherboard, several important parts that are included with your shipment are listed below. If anything listed is damaged or missing, please contact your retailer.

1.1 Checklist

Main Parts List		
Description	Part Number	Quantity
Supermicro Motherboard	X11DPL-i	1
SATA Cables	CBL-0044L	6
I/O Shield	MCP-260-00110-0N	1

Important Links

For your system to work properly, please follow the links below to download all necessary drivers/utilities and the user's manual for your server.

- Supermicro product manuals: <http://www.supermicro.com/support/manuals/>
- Product drivers and utilities: <ftp://ftp.supermicro.com>
- Product safety info: http://www.supermicro.com/about/policies/safety_information.cfm
- If you have any questions, please contact our support team at: support@supermicro.com

This manual may be periodically updated without notice. Please check the Supermicro website for possible updates to the manual revision level.

Figure 1-1. Motherboard Image

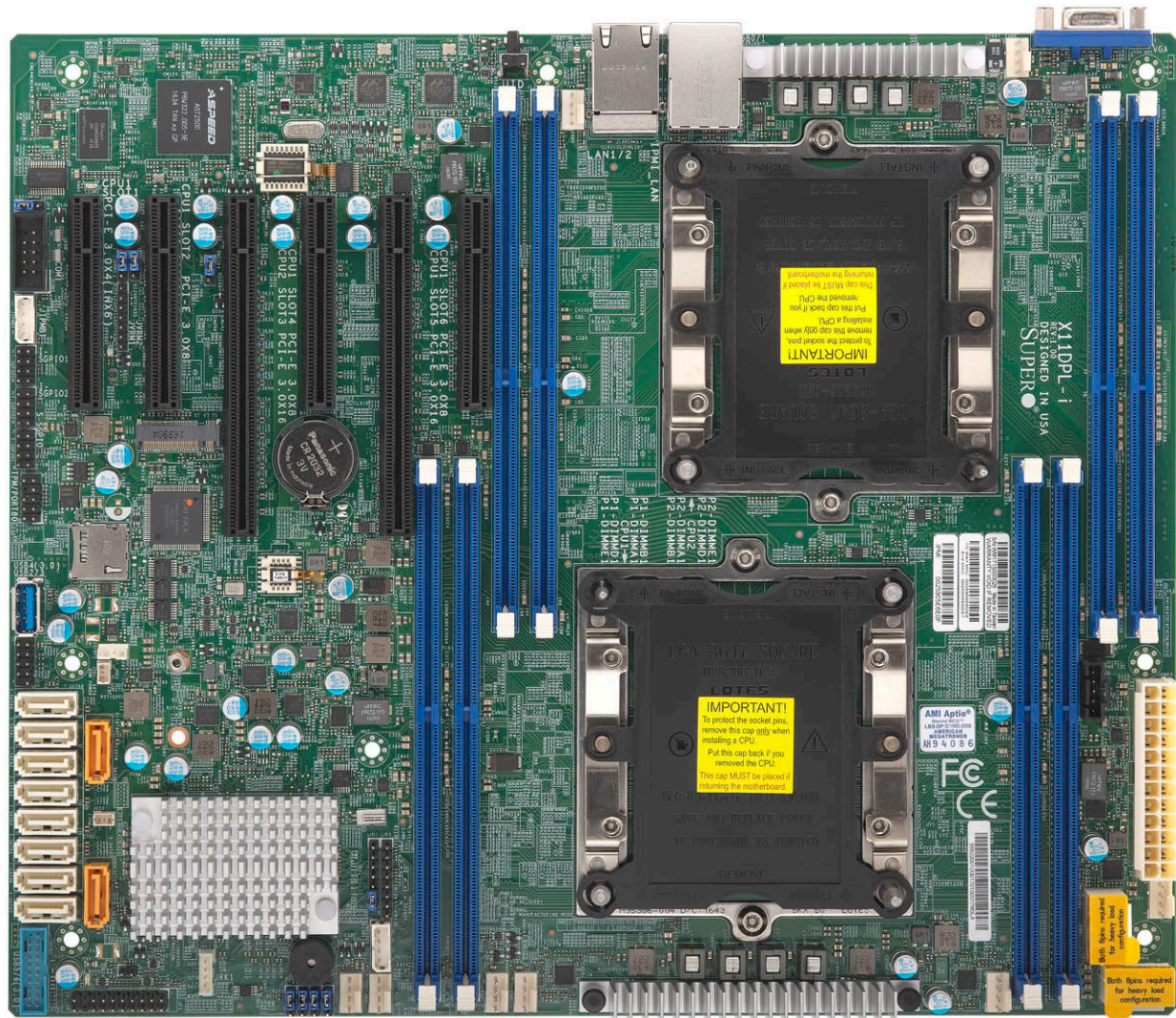



 **Note:** All graphics shown in this manual were based upon the latest PCB revision available at the time of publication of the manual. The motherboard you received may or may not look exactly the same as the graphics shown in this manual.

Figure 1-2. X11DPL-i Motherboard Layout
(not drawn to scale)

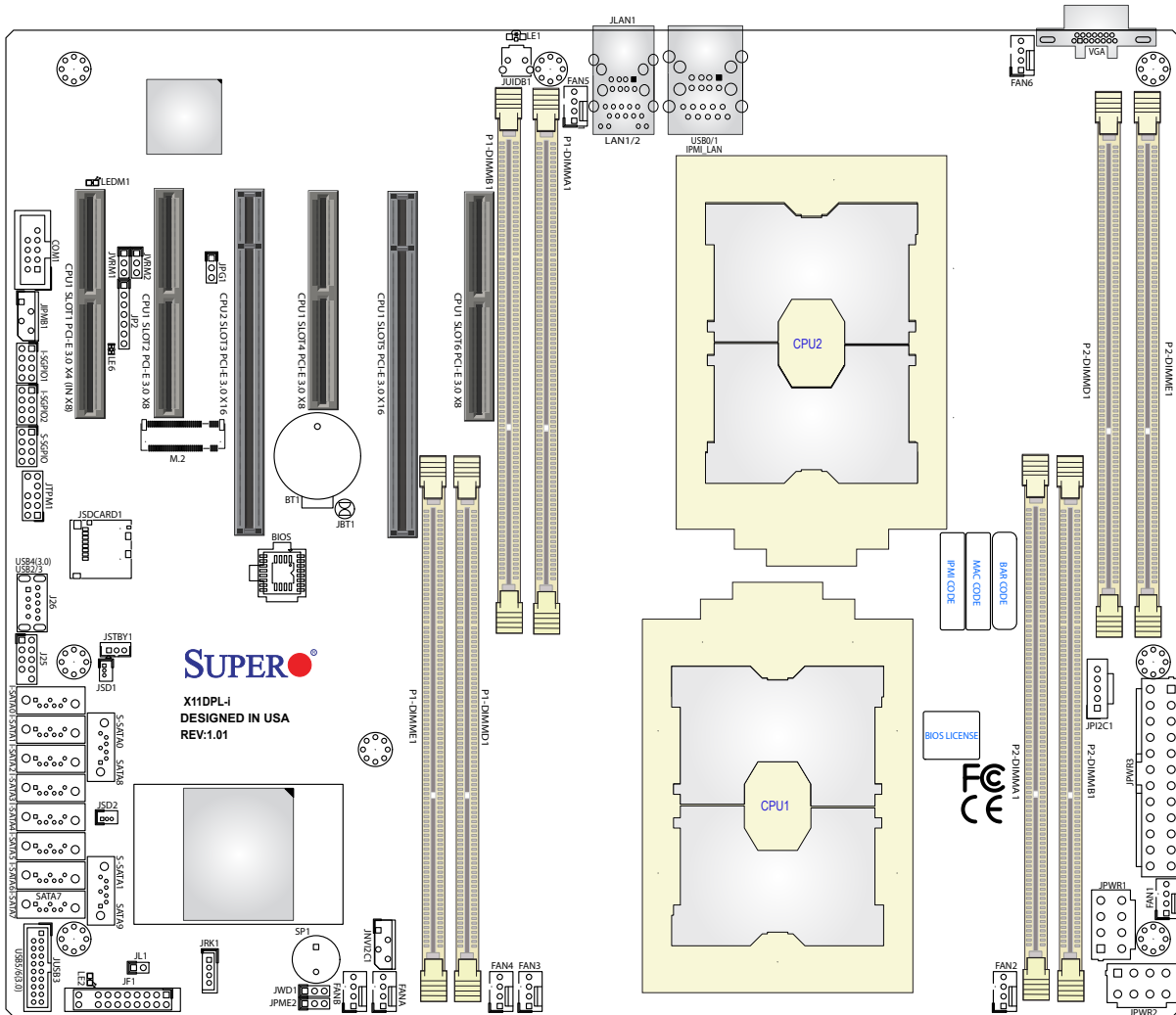

 **Note:** Components not documented are for internal testing only.

Quick Reference

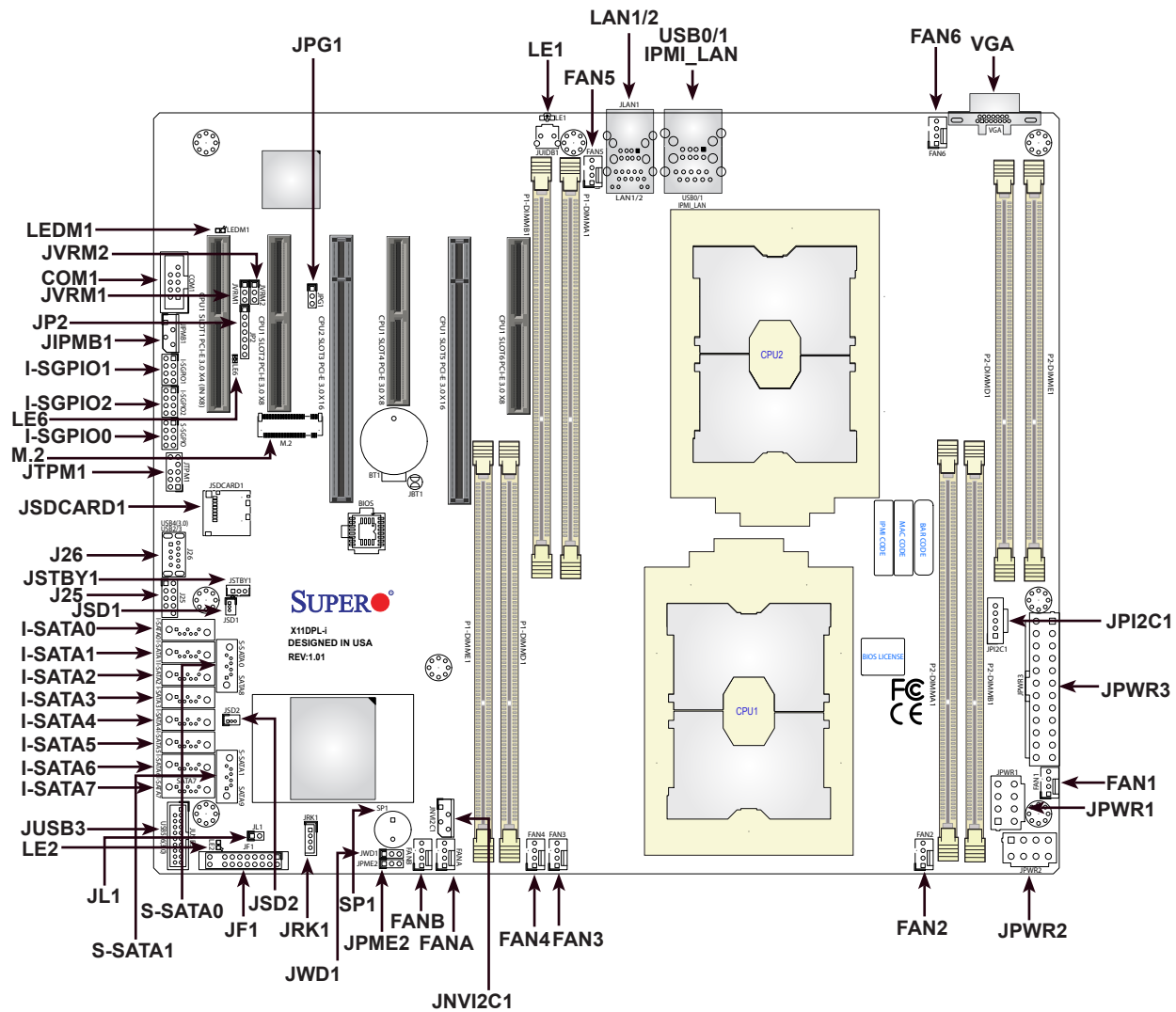

Notes:

- See Chapter 2 for detailed information on jumpers, I/O ports, and JF1 front panel connections.
- "1" indicates the location of Pin 1.
- Jumpers/LED indicators not indicated are used for internal testing only.
- Use only the correct type of onboard CMOS battery as specified by the manufacturer. Do not install the onboard battery upside down to avoid possible explosion.



Quick Reference Table

Jumper	Description	Default Setting
JBT1	Clear CMOS	Open (Normal)
JPG1	VGA Enable	Pins 1-2 (Enabled)
JPME2	Manufacturer (ME) Mode Select	Pins 1-2 (Normal)
JVRM1	VRM SMB Clock (to BMC or PCH)	Pins 1-2 BMC (Normal)
JVRM2	VRM SMB Data (to BMC or PCH)	Pins 1-2 BMC (Normal)
JWD1	Watch-Dog Timer Enable	Pins 1-2 (Reset)

Connector	Description
Battery (BT1)	Onboard CMOS battery
COM 1	Front Panel COM port 1
FAN 1~6	System cooling fan headers
FANA/FANB	Thermal fan headers for I/O add-on cards
JL1	Chassis intrusion header
JF1	Front_Panel_Control header
J25	USB 2.0 Header for USB ports 2/3
J26	USB 3.0 Type A port for USB4
JPWR1/2	8-pin Power connectors
JPWR3	24-pin Power connectors
JPI ² C1	Power Supply I ² C connector
JSD1/JSD2	Power connector SATA DOM
JSTBY1	Wake On LAN header
IPMI_LAN	Dedicated IPMI LAN port
JIPMB1	4-pin external BMC I ² C header (for an IPMI card)
JNVI ² C1	NVMe SMBus (I ² C) header used for PCI-E hot-plug SMBus clock & data connections (an SMCI-proprietary NVMe add-on card and cable are required; available for a Supermicro complete system only)
JRK1	RAID key for CPU NVME SSD
JSDCARD1	Micro SD Card slot
JTPM1	Trusted Platform Module (TPM)/Port 80 connector
M.2	M.2 slot
(I-)SATA0~3, 4~7	I- SATA 3.0 connectors supported by the Intel PCH
(S-)SATA0/1	S- SATA 3.0 connectors supported by the Intel SCU
SP1	Internal speaker
USB0/1	Back panel USB 3.0 ports
VGA	Back panel VGA port

LED	Description	Status
LE1	UID (Unit Identifier) LED	Solid Blue: Unit Identified
LE6	Onboard Power LED	Solid Red: Standby Solid Green: Power On
LEDM1	BMC Heartbeat LED	Blinking Green: BMC Normal

Motherboard Features

Motherboard Features	
CPU	
<ul style="list-style-type: none"> Dual Intel Xeon 81xx/61xx/51xx/41xx/31xx series processors (Socket P) with UPI support of up to 10.4 GT/s  <p>Note: Both CPUs need to be installed for full access to the PCI-E slots, DIMM slots, and onboard controllers. Refer to the block diagram on page 16 to determine which slots or devices may be affected.</p>	
Memory	
<ul style="list-style-type: none"> Integrated memory controller supports up to 1TB of 3DS LRDIMM/LRDIMM/RDIMM/NV-DIMM DDR4 ECC 2666/2400/2133 MHz memory in 8 memory slots. 	
DIMM Size	
<ul style="list-style-type: none"> Up to 128GB at 1.2V 	
 <p>Note 1: Memory speed support depends on the processors used in the system.</p> <p>Note 2: For the latest CPU/memory updates, please refer to our website at http://www.supermicro.com/products/motherboard.</p>	
Chipset	
<ul style="list-style-type: none"> Intel C621 	
Expansion Slots	
<ul style="list-style-type: none"> Two (2) PCI-Express 3.0 x16 slots supported by CPU1 and CPU2 Three (3) PCI-Express 3.0 x8 slots supported by CPU1 One (1) PCI-Express 3.0 x4 in x8 supported by CPU1 One (1) PCI-Express 3.0 x4 M.2 Connector 	
BaseBoard Management Controller (BMC)	
<ul style="list-style-type: none"> ASpeed AST 2500 Baseboard Management Controller (BMC) supports IPMI 2.0 One (1) dedicated IPMI LAN located on the rear IO backpanel 	
Graphics	
<ul style="list-style-type: none"> Graphics controller via AST 2500 BMC (BaseBoard Management Controller) 	
Network	
<ul style="list-style-type: none"> Dual LAN with Marvell 88E1512 Gigabit Ethernet PHY 	
I/O Devices	
<ul style="list-style-type: none"> SATA 3.0 RAID (PCH) 	Ten (8 SATA + 2 SATA DOM) SATA ports <ul style="list-style-type: none"> I-SATA0~7 S-SATA0/1 RAID 0, 1, 5, 10
Peripheral Devices	
<ul style="list-style-type: none"> Two (2) USB 2.0 ports on the rear I/O panel (USB 0/1) One (1) internal USB 2.0 header for two (2) USB front panel support (USB 2/3) One (1) Type A USB 3.0 connector (USB 4) One (1) internal USB 3.0 header for two (2) USB front panel support (USB 5/6) 	



Note: The table above is continued on the next page.

Motherboard Features
<p>BIOS</p> <ul style="list-style-type: none"> • 256Mb AMI BIOS SPI Flash ROM • ACPI 6.0 or later, SPI dual/quad speed support, and SMBIOS 3.1.1 or later • Riser Card auto detection support
<p>Power Management</p> <ul style="list-style-type: none"> • ACPI power management • Power button override mechanism • Power-on mode for AC power recovery • Intel® Intelligent Power Node Manager 3.0 (available when the Supermicro Power Manager [SPM] is installed and a special power supply is used. See the note on page 20.) • Management Engine (ME)
<p>System Health Monitoring</p> <ul style="list-style-type: none"> • Onboard voltage monitoring for +1.8V, +3.3V, +5V, +12V, +3.3V standby, +5V standby, VBAT, CPU Core, memory, PCH temperature, system temperature, and memory temperature • CPU 4+1 phase switching voltage regulator • CPU thermal trip support • Status monitor for speed control • Status monitor for on/off control • CPU Thermal Design Power (TDP) support of up to 140W (See Note 1 on next page.)
<p>Fan Control</p> <ul style="list-style-type: none"> • Eight 4-pin fan headers • Fan status monitoring via IPMI connections • Low-noise fan speed control
<p>System Management</p> <ul style="list-style-type: none"> • Trusted Platform Module (TPM) 2.0 • PECL (Platform Environment Control Interface)/ TSI 2.0 support • SuperDoctor® 5, Watch Dog, Non-maskable interrupt (NMI), RoHS • IPMIView, SMCIPMITOOL, IPMICFG
<p>LED Indicators</p> <ul style="list-style-type: none"> • CPU/Overheating • Power/Suspend-state indicator • Fan failure • UID/remote UID • HDD activity • LAN activity
<p>Dimensions</p> <ul style="list-style-type: none"> • 12.07" (L) x 10.15" (W) (306.58 mm x 257.81 mm)

 **Note 1:** The CPU maximum thermal design power (TDP) is subject to chassis and heatsink cooling restrictions. For proper thermal management, please check the chassis and heatsink specifications for proper CPU TDP sizing.

 **Note:** The table above is continued on the next page.

 **Note 2:** For IPMI configuration instructions, please refer to the Embedded IPMI Configuration User's Guide available at <http://www.supermicro.com/support/manuals/>.

Note 3: It is strongly recommended that you change BMC log-in information upon initial system power-on. The manufacture default username is ADMIN and the password is ADMIN. For proper BMC configuration, please refer to http://www.supermicro.com/products/info/files/IPMI/Best_Practices_BMC_Security.pdf

Figure 1-3.
System Block Diagram

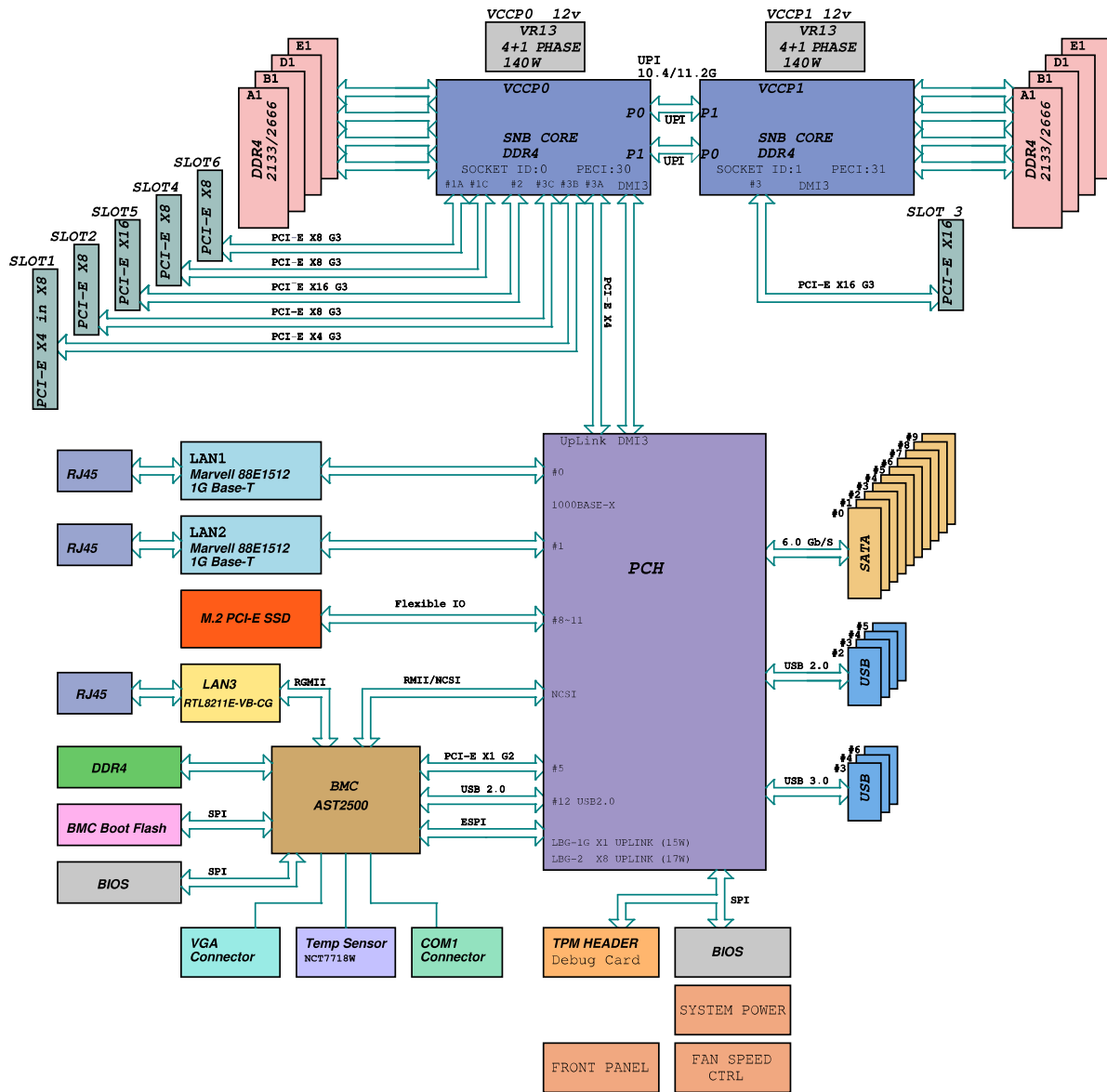

Note: This is a general block diagram and may not exactly represent the features on your motherboard. See the previous pages for the actual specifications of your motherboard.

1.2 Processor and Chipset Overview

Built upon the functionality and capability of the Intel Xeon 81xx/61xx/51xx/41xx/31xx series processors (Socket P) and the Intel C621 chipset, the X11DPL-i motherboard provides a cost effective design, power efficiency, and maximum PCI-E capacity. With M.2 support and six PCI-E slots in a small DP Form Factor, the X11DPL-i combines high-end performance, excellent value, and the latest in SSD and SATA support. This motherboard is optimized for high performance server platforms.

The Intel Xeon 81xx/61xx/51xx/41xx/31xx series processors (Socket P) and the Intel C621 PCH support the following features:

- DDR4 288-pin memory support on Socket P
- Support for MCTP Protocol
- Support for Management Engine (ME)
- Support of SMBus speeds of up to 400KHz for BMC connectivity
- Improved I/O flexibility
- SPI enhancements
- Intel® Node Manager 3.0 for advanced power monitoring, capping, and management for BMC enhancement
- The BMC supports remote management, virtualization, and the security package for enterprise platforms



Note: Node Manager 3.0 support is dependent on the power supply used in the system.

1.3 Special Features

This section describes the health monitoring features of the motherboard. The motherboard has an onboard ASpeed 2500 Baseboard Management Controller (BMC) that supports system health monitoring.

Recovery from AC Power Loss

The Basic I/O System (BIOS) provides a setting that determines how the system will respond when AC power is lost and then restored to the system. You can choose for the system to remain powered off (in which case you must press the power switch to turn it back on), or for it to automatically return to the power-on state. See the Advanced BIOS Setup section for this setting. The default setting is Last State.

1.4 System Health Monitoring

This section describes the health monitoring features of the X11DPL-i motherboard. The motherboard has an onboard Baseboard Management Controller (BMC) chip that supports system health monitoring. Once a voltage becomes unstable, a warning is given or an error message is sent to the screen. The user can adjust the voltage thresholds to define the sensitivity of the voltage monitor.

Onboard Voltage Monitors

The onboard voltage monitor will continuously scan crucial voltage levels. Once a voltage becomes unstable, it will give a warning or send an error message to the screen. The user can adjust the voltage thresholds to define the sensitivity of the voltage monitor. Real time readings of these voltage levels are all displayed in BIOS.

Fan Status Monitor with Firmware Control

The system health monitor embedded in the BMC chip can check the RPM status of the cooling fans. The CPU and chassis fans are controlled via IPMI.

Environmental Temperature Control

System Health sensors in the BMC monitor the temperatures and voltage settings of onboard processors and the system in real time via the IPMI interface. Whenever the temperature of the CPU or the system exceeds a user-defined threshold, system/CPU cooling fans will be turned on to prevent the CPU or the system from overheating.



Note: To avoid possible system overheating, please be sure to provide adequate air-flow to your system.

System Resource Alert

This feature is available when used with SuperDoctor 5®. SuperDoctor 5 is used to notify the user of certain system events. For example, you can configure SuperDoctor 5 to provide you with warnings when the system temperature, CPU temperatures, voltages and fan speeds go beyond a predefined range.

1.5 ACPI Features

ACPI stands for Advanced Configuration and Power Interface. The ACPI specification defines a flexible and abstract hardware interface that provides a standard way to integrate power management features throughout a computer system including its hardware, operating system and application software. This enables the system to automatically turn on and off peripherals such as network cards, hard disk drives and printers.

In addition to enabling operating system-directed power management, ACPI also provides a generic system event mechanism for Plug and Play and an operating system-independent interface for configuration control. ACPI leverages the Plug and Play BIOS data structures while providing a processor architecture-independent implementation that is compatible with Windows 8, Windows 10, and Windows 2012 operating systems.

1.6 Power Supply

As with all computer products, a stable power source is necessary for proper and reliable operation. It is even more important for processors that have high CPU clock rates. In areas where noisy power transmission is present, you may choose to install a line filter to shield the computer from noise. It is recommended that you also install a power surge protector to help avoid problems caused by power surges.

1.7 Super I/O

The Super I/O (ASpeed AST2500 chip) provides a high-speed, 16550 compatible serial communication port (UART), which supports serial infrared communication. The UART includes send/receive FIFO, a programmable baud rate generator, complete modem control capability, and a processor interrupt system. The UART provides legacy speed with baud rate of up to 115.2 Kbps as well as an advanced speed with baud rates of 250 K, 500 K, or 1 Mb/s, supporting higher speed modems.

The Super I/O provides functions that comply with ACPI (Advanced Configuration and Power Interface), which includes support of legacy and ACPI power management through a SMI or SCI function pin. It also features auto power management to reduce power consumption.

1.8 Advanced Power Management

The following new advanced power management features are supported by the motherboard.

Management Engine (ME)

The Management Engine, which is an ARC controller embedded in the IOH (I/O Hub), provides Server Platform Services (SPS) to your system. The services provided by SPS are different from those provided by the ME on client platforms.

Chapter 2

Installation

2.1 Static-Sensitive Devices

Electrostatic Discharge (ESD) can damage electronic components. To avoid damaging your motherboard and your system, it is important to handle it very carefully. The following measures are generally sufficient to protect your equipment from ESD.

Precautions

- Use a grounded wrist strap designed to prevent static discharge.
- Touch a grounded metal object before removing the board from the antistatic bag.
- Handle the board by its edges only; do not touch its components, peripheral chips, memory modules or gold contacts.
- When handling chips or modules, avoid touching their pins.
- Put the motherboard and peripherals back into their antistatic bags when not in use.
- For grounding purposes, make sure that your chassis provides excellent conductivity between the power supply, the case, the mounting fasteners and the motherboard.
- Use only the correct type of CMOS onboard battery as specified by the manufacturer. Do not install the CMOS battery upside down, which may result in a possible explosion.

Unpacking

The motherboard is shipped in antistatic packaging to avoid static damage. When unpacking the motherboard, make sure that the person handling it is static protected.

2.2 Motherboard Installation

All motherboards have standard mounting holes to fit different types of chassis. Make sure that the locations of all the mounting holes for both the motherboard and the chassis match. Although a chassis may have both plastic and metal mounting fasteners, metal ones are highly recommended because they ground the motherboard to the chassis. Make sure that the metal standoffs click in or are screwed in tightly.



**Phillips
Screwdriver
(1)**



**Phillips
Screws (8)**



Standoffs (8)

Tools Needed

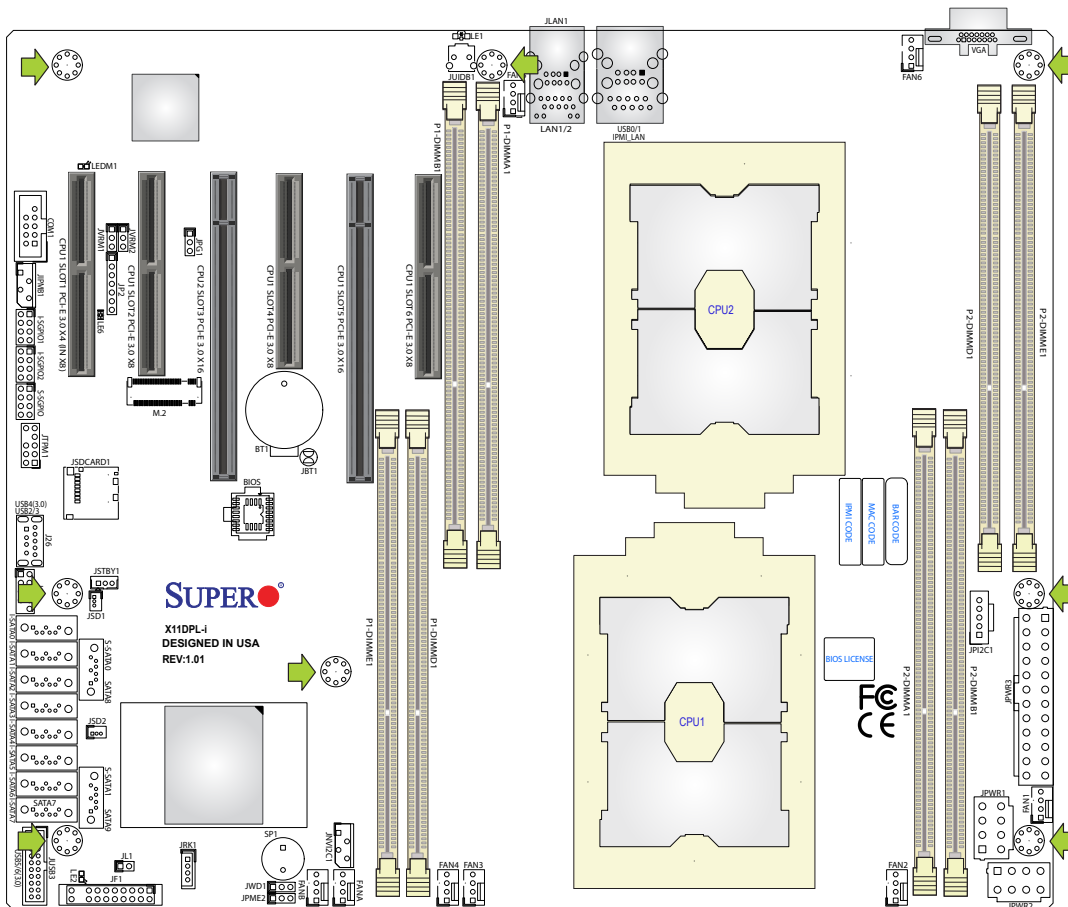

Location of Mounting Holes



- Notes:**
- 1) To avoid damaging the motherboard and its components, please do not use a force greater than 8 lb/inch on each mounting screw during motherboard installation.
 - 2) Some components are very close to the mounting holes. Please take precautionary measures to avoid damaging these components when installing the motherboard to the chassis.

Installing the Motherboard

1. Install the I/O shield into the back of the chassis.

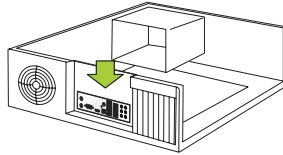

2. Locate the mounting holes on the motherboard. See the previous page for the location.

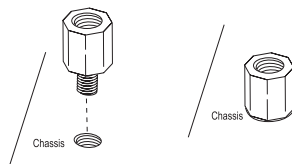

3. Locate the matching mounting holes on the chassis. Align the mounting holes on the motherboard against the mounting holes on the chassis.

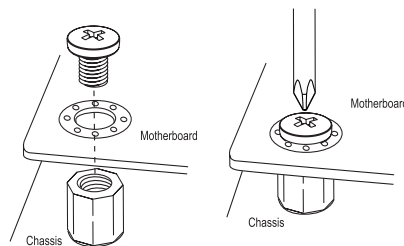

4. Install standoffs in the chassis as needed.
5. Install the motherboard into the chassis carefully to avoid damaging other motherboard components.
6. Using the Phillips screwdriver, insert a Phillips head #6 screw into a mounting hole on the motherboard and its matching mounting hole on the chassis.
7. Repeat Step 5 to insert #6 screws into all mounting holes.
8. Make sure that the motherboard is securely placed in the chassis.

 **Note:** Images displayed in this manual are for illustration only. Your chassis or components might look different from those shown in this manual.

2.3 Processor and Heatsink Installation

Warning: When handling the processor package, avoid placing direct pressure on the label area of the fan. Also, improper CPU installation or socket misalignment can cause serious damage to the CPU or the motherboard that will require RMA repairs. Please read and follow all instructions thoroughly before installing your CPU and heatsink.



Notes:

- Always connect the power cord last, and always remove it before adding, removing or changing any hardware components. Make sure that you install the processor into the CPU socket before you install the CPU heatsink.
- If you buy a CPU separately, make sure that you use an Intel-certified multi-directional heatsink only.
- Make sure to install the motherboard into the chassis before you install the CPU heatsink.
- When receiving a motherboard without a processor pre-installed, make sure that the plastic CPU socket cap is in place and none of the socket pins are bent; otherwise, contact your retailer immediately.
- Refer to the Supermicro website for updates on CPU support.

The Processor

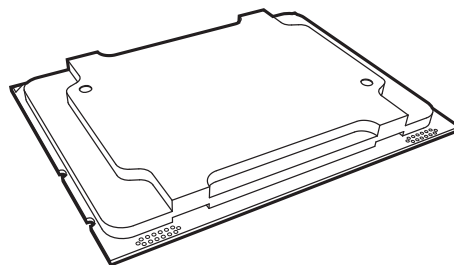

Xeon 81xx/61xx/51xx/41xx/31xx processor



Note: All graphics, drawings and pictures shown in this manual are for illustration only. The components that came with your machine may or may not look exactly the same as those shown in this manual.

Overview of the Processor Socket Assembly

The processor socket assembly contains 1) Xeon 81xx/61xx/51xx/41xx/31xx processor 2) CPU/heatsink carrier, 3) dust cover, and 4) CPU socket.

1. Xeon 81xx/61xx/51xx/41xx/31xx

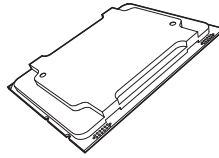

2. CPU/Heatsink Carrier

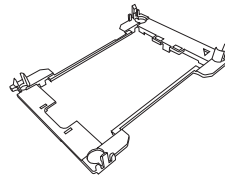

3. Dust Cover

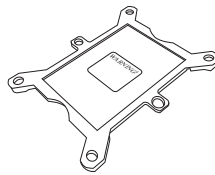

4. CPU Socket

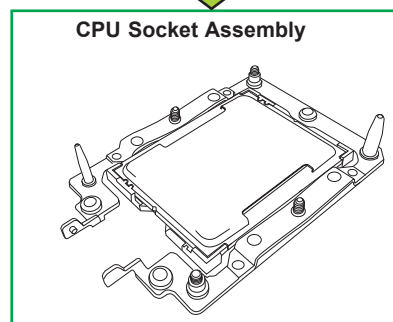
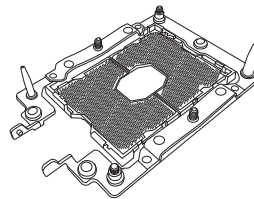

Note: Be sure to cover the CPU socket with the dust cover when the CPU is not installed.

Overview of the Processor Heatsink Module

The processor heatsink module (PHM) contains 1) a passive heatsink, 2) a CPU/heatsink carrier, and 3) the Intel Processor (Non-F Model)

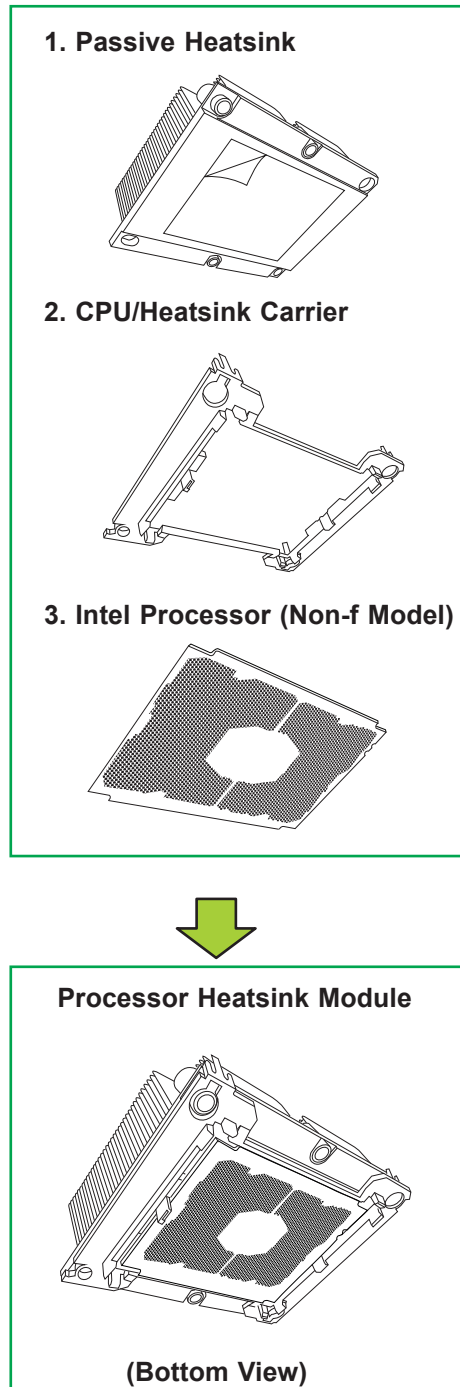

Preparing the CPU Socket for Installation

This motherboard comes with the CPU socket pre-assembled in the factory. The CPU socket contains 1) a dust cover, 2) a socket bracket, 3) the CPU (LGA3647) socket, and 4) a back plate. These components are pre-installed on the motherboard before shipping.

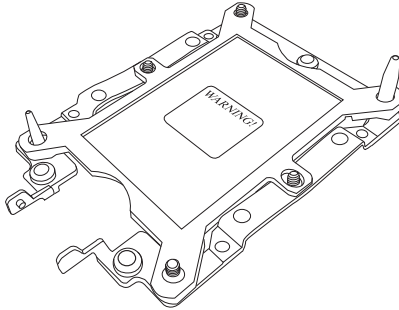

Processor Socket Assembly

Removing the Dust Cover from the CPU Socket

Remove the dust cover from the CPU socket, exposing the LGA3647 socket and socket pins as shown on the illustration below.

 **Note:** Do not touch the socket pins to avoid damaging them, causing the CPU to malfunction.

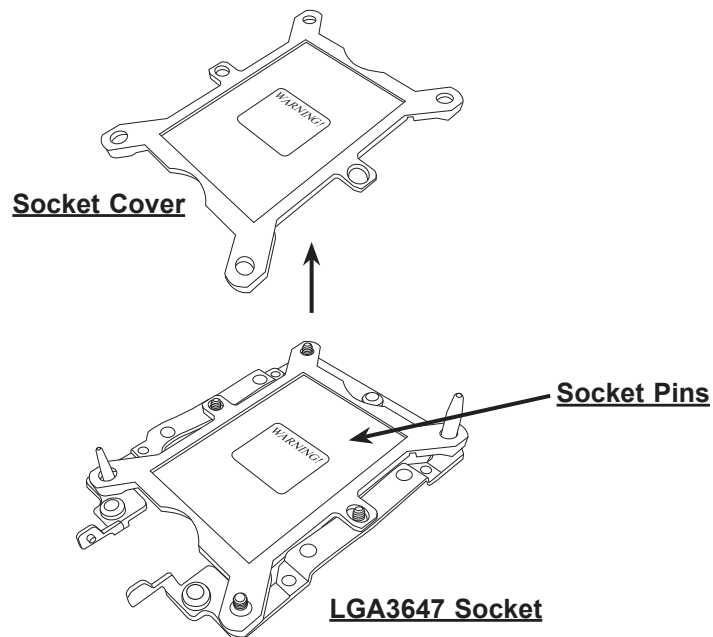

Attaching the Processor to the CPU/Heatsink Carrier

To properly install the CPU onto the CPU/heatsink carrier, please follow the steps below.

1. Locate Pin 1 (Notch A), Notch B, and Notch C on the CPU and locate Pin 1 (Notch A), Notch B, and Notch C on the CPU/heatsink carrier.
2. Align Pin 1 (Notch A), Notch B, and Notch C on the CPU with the corresponding notches on the carrier. Once they are aligned, carefully insert the CPU into the carrier until you hear a click. Once the CPU is properly mounted onto the carrier, the CPU/carrier assembly is made.

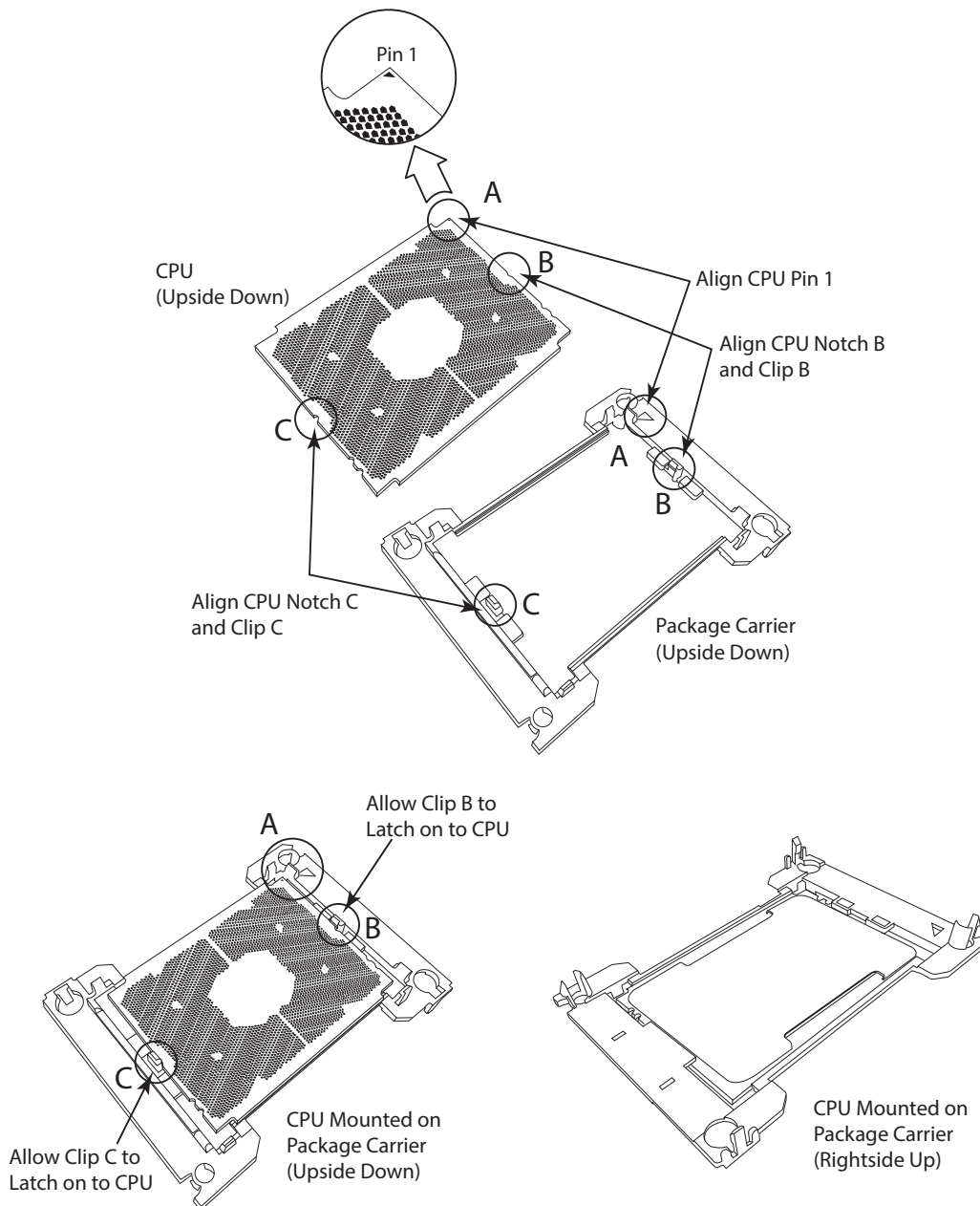

Attaching the CPU/Carrier Assembly to the Passive Heatsink to Form the Processor Heatsink Module (PHM)

After you have made a CPU/carrier assembly, please follow the steps below to mount the assembly onto the heatsink to create the Processor Heatsink Module (PHM).

1. Place the heatsink upside down with the thermal grease facing up. Locate two larger mounting holes (A, B) at the diagonal corners of the heatsink, and two smaller mounting holes (C, D) on the heatsink.
2. Hold the CPU/carrier at the center edge, and turn it upside down with the CPU pins facing up. Locate the two larger holes (1, 2) at the diagonal corners of the carrier and the smaller holes of the same size (3, 4) on the carrier. Please note the mounting clips located next to every mounting hole on the carrier.

3. Align the larger holes (1, 2) on the carrier against the larger mounting holes (A, B) on the heatsink and smaller holes (3, 4) on the carrier against the smaller mounting holes (C, D) on the heatsink. Insert the mounting clips next to the larger hole on the carrier into the larger mounting hole on the heatsink (1→A, 2→B) and snap the mounting clips next to the smaller holes on the carrier onto the edges of the heatsink next to the smaller holes (3→C, 4→D) making sure that the mounting clips snap into place, and that the CPU/carrier assembly is properly mounted onto the heatsink. By mounting the CPU/carrier assembly to the heatsink, the Processor Heatsink Module (PHM) is assembled.

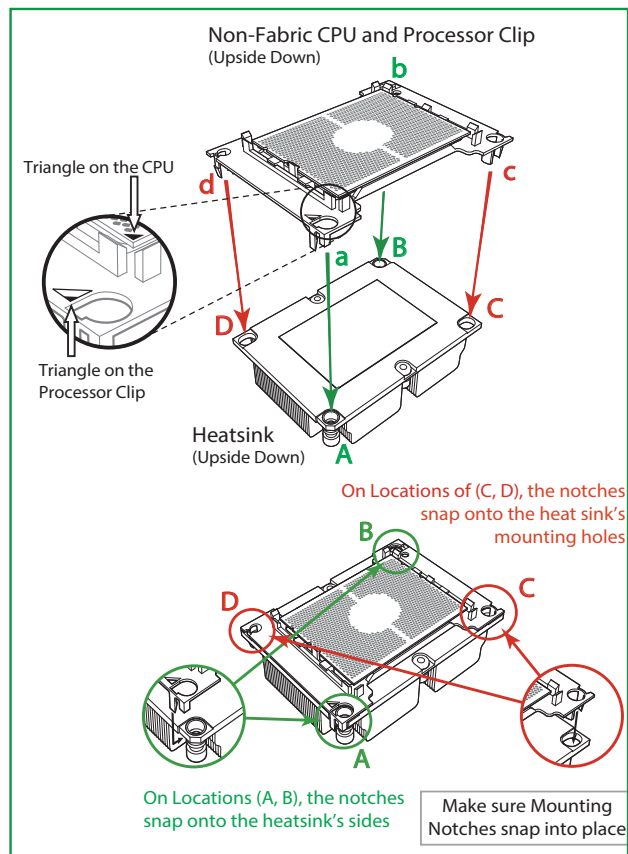

Installing the Processor Heatsink Module (PHM)

1. Once you have assembled the processor heatsink module (PHM) by following the instructions listed on the previous page, align the processor heatsink module with the CPU socket on the motherboard.
2. Align the large hole on the heatsink against the large notch on the CPU socket, the small hole on the heatsink against the small notch on the socket. Carefully insert the PHM into the socket, making sure that the large and small notches fit through the corresponding mounting holes on the socket. The PHM will only fit one way. If it does not fit correctly, remove it and try again.
3. Using a T30-size star driver bit, tighten four screws into the mounting holes on the socket to securely install the PHM into the motherboard, starting with the mounting hole marked #1 (in the sequence of 1, 2, 3, and 4).

 **Note:** Do not use excessive force when tightening the screws to avoid damaging the CPU and the socket.

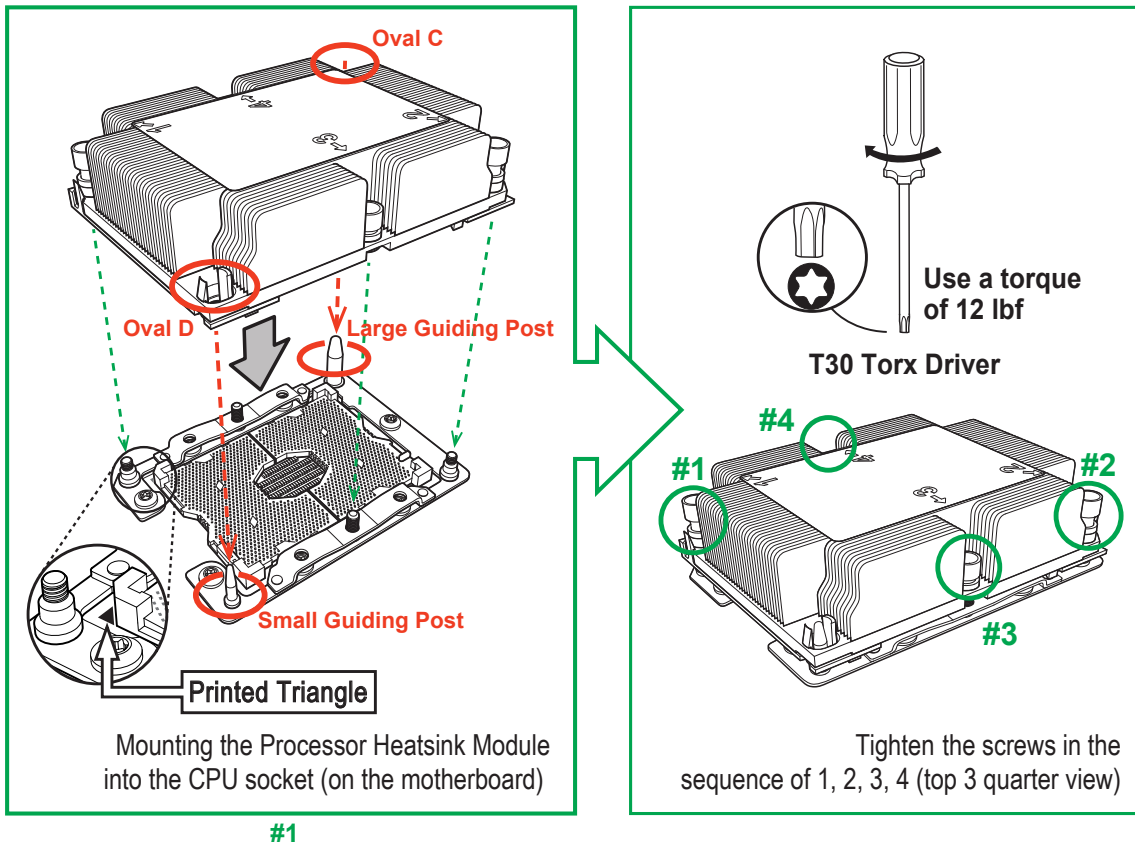

Removing the Processor Heatsink Module (PHM)

Before starting to remove the processor heatsink module (PHM), unplug power cord from the power outlet.

1. Using a T30-size star driver, turn the screws on the PHM counterclockwise to loosen it from the socket, starting with screw marked #4 (in the sequence of 4, 3, 2, 1).
2. After all four screws are removed, wiggle the PHM gently and pull up to remove it from the socket.

 **Note:** To properly remove the processor heatsink module, be sure to loosen and remove the screws on the PHM in the sequence of 4, 3, 2, 1 as shown below.

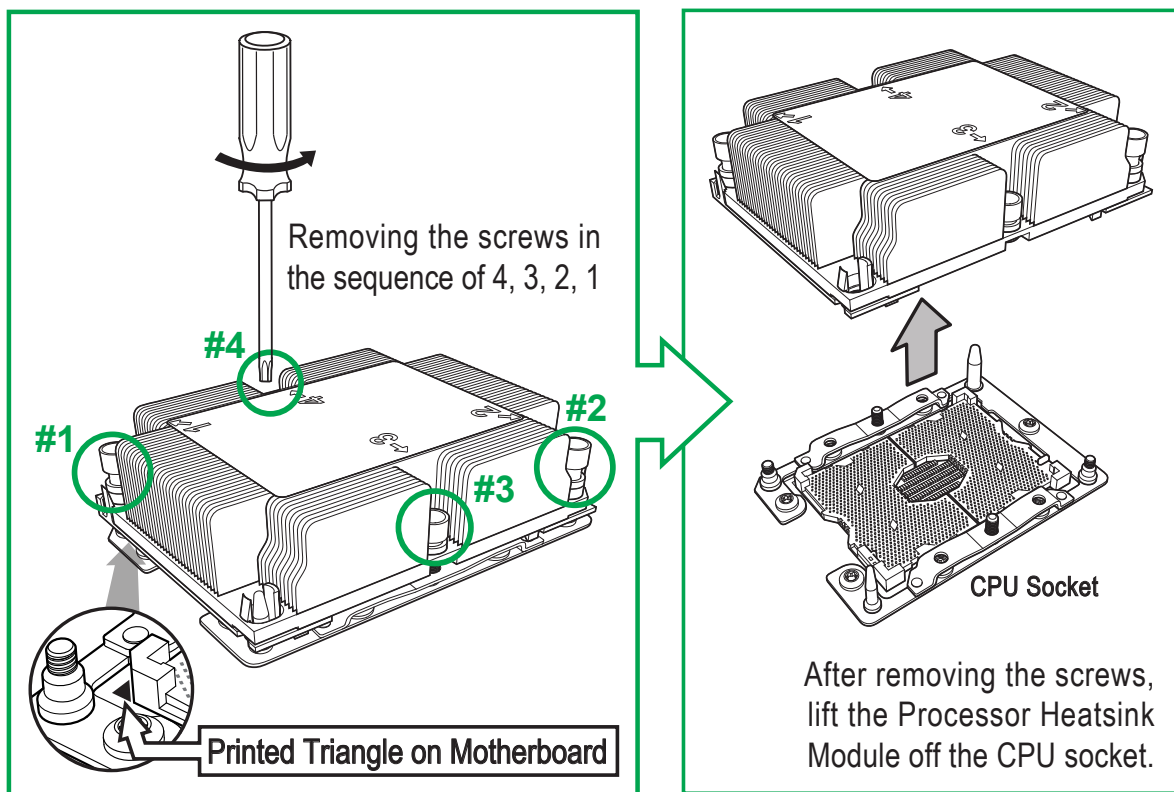

2.4 Memory Support and Installation



Note: Check the Supermicro website for recommended memory modules.



Important: Exercise extreme care when installing or removing DIMM modules to prevent any damage.

Memory Support

The X11DPL-i supports up to up to 1TB of 3DS LRDIMM/LRDIMM/RDIMM/NV-DIMM DDR4 ECC 2666/2400/2133 MHz memory in 8 memory slots. Populating these DIMM modules with a pair of memory modules of the same type and size will result in interleaved memory, which will improve memory performance.



Notes: 1. Be sure to use the memory modules of the same type and speed on the motherboard. Mixing of memory modules of different types and speeds is not allowed.

DDR4 Memory Support (for 1-Slot Per-Channel Configuration)					
Type	Ranks Per DIMM and Data Width	DIMM Capacity (GB)		Speed (MT/s); Voltage (V); Slots per Channel (SPC) and DIMMs per Channel (DPC)	
				1 Slot per Channel	
		1DPC (1-DIMM per Channel)			
		4 Gb	8 Gb	1.2 V	
RDIMM	SRx4	8 GB	16 GB	2666	
RDIMM	SRx8	4 GB	8 GB	2666	
RDIMM	DRx8	8 GB	16 GB	2666	
RDIMM	DRx4	16 GB	32 GB	2666	
RDIMM 3Ds	QRX4	N/A	2H-64GB	2666	
RDIMM 3Ds	8RX4	N/A	4H-128GB	2666	
LRDIMM	QRx4	32 GB	64 GB	2666	
LRDIMM 3Ds	QRX4	N/A	2H-64GB	2666	
	8Rx4	N/A	4H-128 GB	2666	

DIMM Population Requirements for the 81xx/61xx/51xx/41xx/31xx Processors

For optimal memory performance, follow the tables below when populating memory modules.

Key Parameters for DIMM Configurations	
Parameters	Possible Values
Number of Channels	1, 2, 3, 4, 5, or 6
Number of DIMMs per Channel	1DPC (1 DIMM Per Channel)
DIMM Type	RDIMM (w/ECC), LRDIMM, 3DS-LRDIMM
DIMM Construction	<ul style="list-style-type: none"> • non-3DS RDIMM Raw Cards: A/B (2RX4), C (1RX4), D (1RX8), E (2RX8) • 3DS RDIMM Raw Cards: A/B (4RX4) • non-3DS LRDIMM Raw Cards: D/E (4RX4) • 3DS LRDIMM Raw Cards: A/B (8RX4)

General Population Requirements
DIMM Mixing Rules
<ul style="list-style-type: none"> • Please populate all memory modules with DDR4 DIMMs only. • X4 and X8 DIMMs can be mixed in the same channel. • Mixing of LRDIMMs and RDIMMs is not allowed in the same channel, across different channels, and across different sockets. • Mixing of non-3DS and 3DS LRDIMM is not allowed in the same channel, across different channels, and across different sockets.

Mixing of DIMM Types within a Channel			
DIMM Types	RDIMM	LRDIMM	3DS LRDIMM
RDIMM	Allowed	Not Allowed	Not Allowed
LRDIMM	Not Allowed	Allowed	Not Allowed
3DS LRDIMM	Not Allowed	Not Allowed	Allowed

DIMM Installation

1. Insert DIMM modules in the following order: For CPU1, begin with P1-DIMMA1, P1-DIMMB1, P1-DIMMD1 then P1-DIMME1. For CPU2, begin with P2-DIMMA1, P2-DIMMB1, P2-DIMMD1 then P2-DIMME1. For the system to work properly, please use memory modules of the same type and speed on the motherboard.
2. Push the release tabs outwards on both ends of the DIMM slot to unlock it.
3. Align the key of the DIMM module with the receptive point on the memory slot.
4. Align the notches on both ends of the module against the receptive points on the ends of the slot.
5. Use two thumbs together to press the notches on both ends of the module straight down into the slot until the module snaps into place.
6. Press the release tabs to the lock positions to secure the DIMM module into the slot.

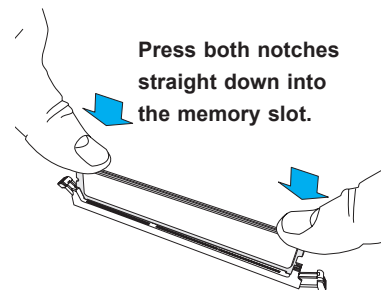
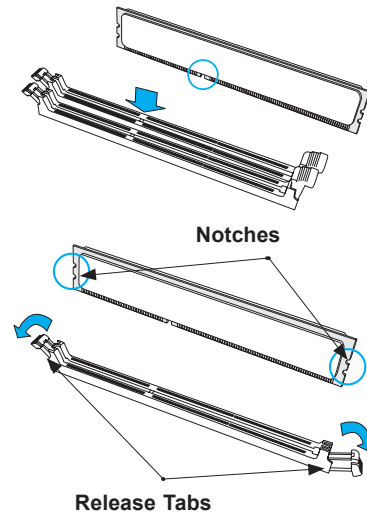
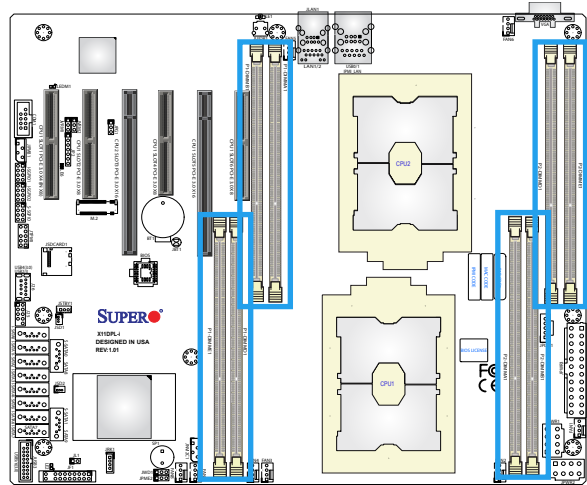

DIMM Removal

Reverse the steps above to remove the DIMM modules from the motherboard.

2.5 Rear I/O Ports

See the figure below for the locations and descriptions of the various I/O ports on the rear of the motherboard.

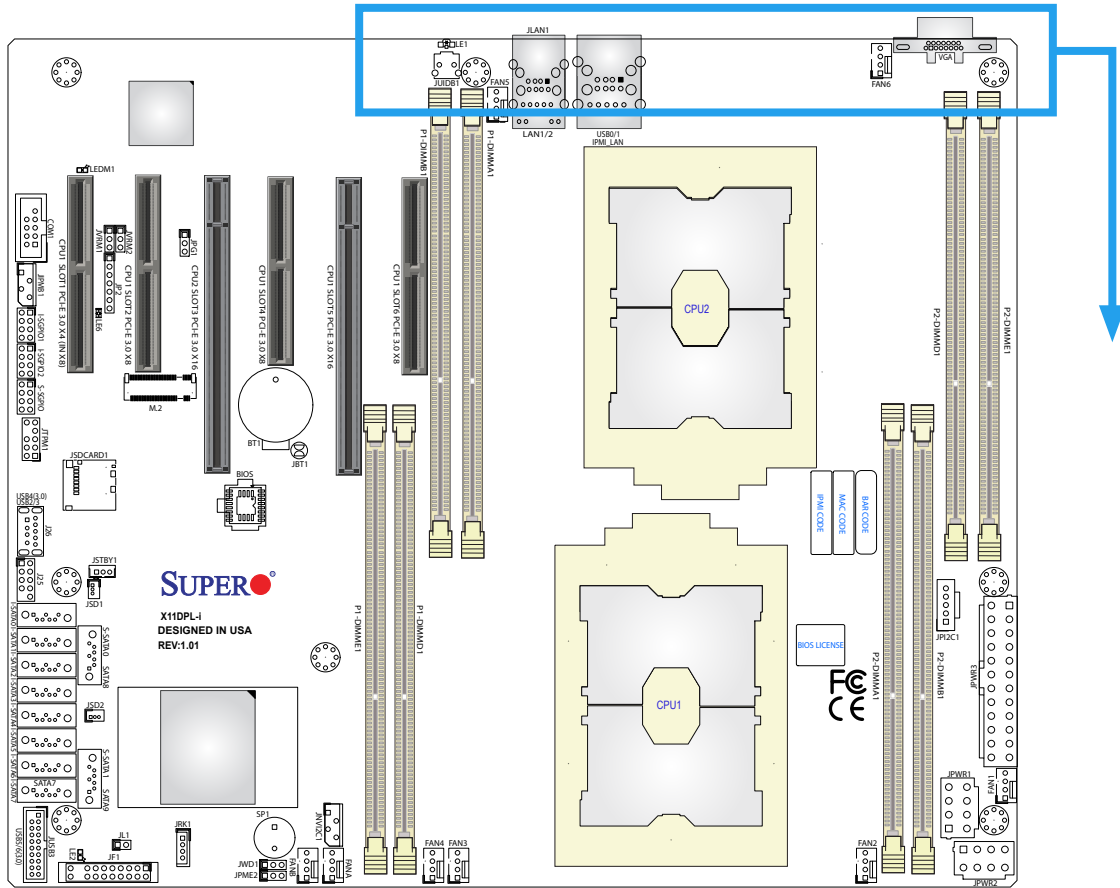

Back panel I/O Port Locations and Definitions

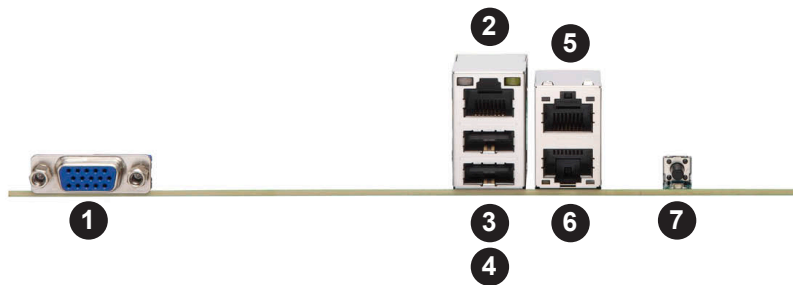

Back Panel I/O Ports			
No.	Description	No.	Description
1.	VGA port	5.	LAN2
2.	Dedicated IPMI LAN	6.	LAN1
3.	USB1 (2.0)	7.	Unit Identifier Switch
4.	USB0 (2.0)		

VGA Port

The onboard VGA port is located next to IPMI LAN port on the I/O back panel. Use this connection for VGA display.

Unit Identifier Switch/UID LED Indicator

A Unit Identifier (UID) switch (UID) and a UID LED Indicator (LE1) are located on the I/O back panel. When you press the UID switch, the UID LED indicator will be turned on. Press the UID switch again to turn off the LED. The UID Indicator provides easy identification of a system unit that may be in need of service.

 **Note:** UID can also be triggered via IPMI on the motherboard. For more information on IPMI, please refer to the IPMI User's Guide posted on our website at <http://www.supermicro.com>.

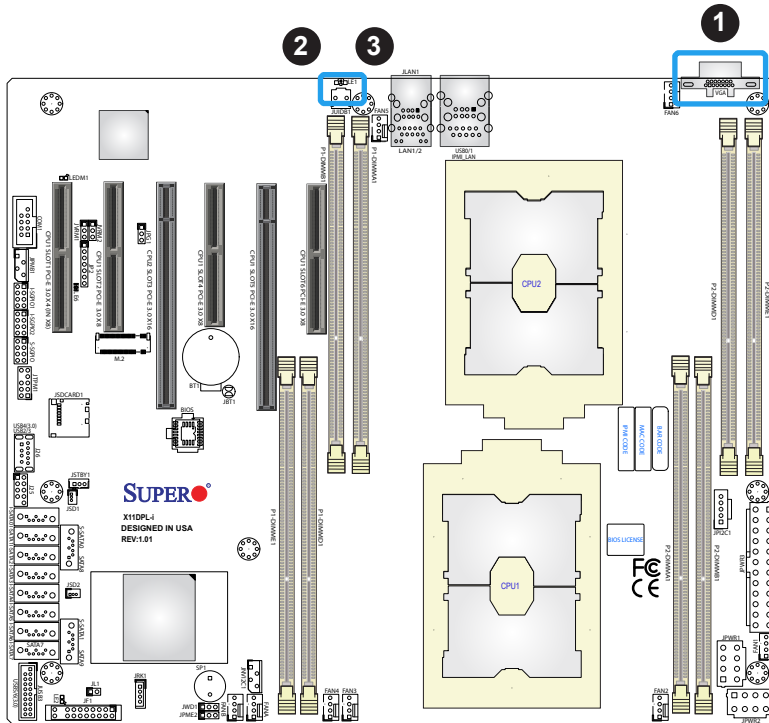

UID LED Pin Definitions	
Color	Status
Blue	On
	Unit Identified

UID Switch Pin Definitions	
Pin#	Definition
1	Button In
2	Ground
3	Ground
4	Ground

1. VGA Port
2. UID Switch
3. UID LED

Universal Serial Bus (USB) Ports

There are two USB 2.0 ports (USB0/1) on the I/O back panel.

Pin#	Definition	Pin#	Definition
1	+5V	5	+5V
2	USB_N	6	USB_N
3	USB_P	7	USB_P
4	Ground	8	Ground

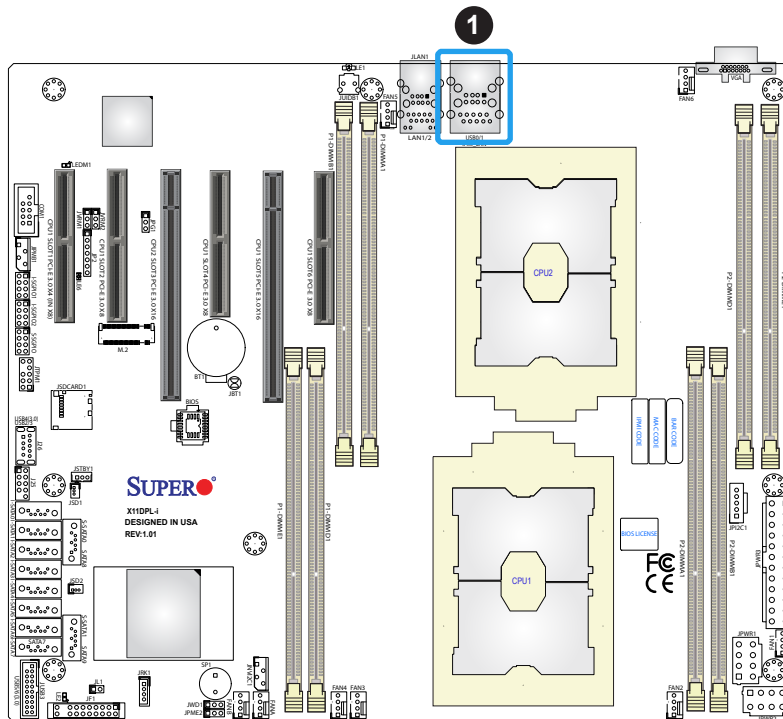

1. USB0/1

Ethernet Ports

Two LAN ports (LAN1/LAN2) and a dedicated IPMI LAN are located on the I/O back panel. IPMI_LAN is supported by the onboard AST 2500 BMC and accepts an RJ45 type cable. Refer to the LED Indicator Section for LAN LED information.

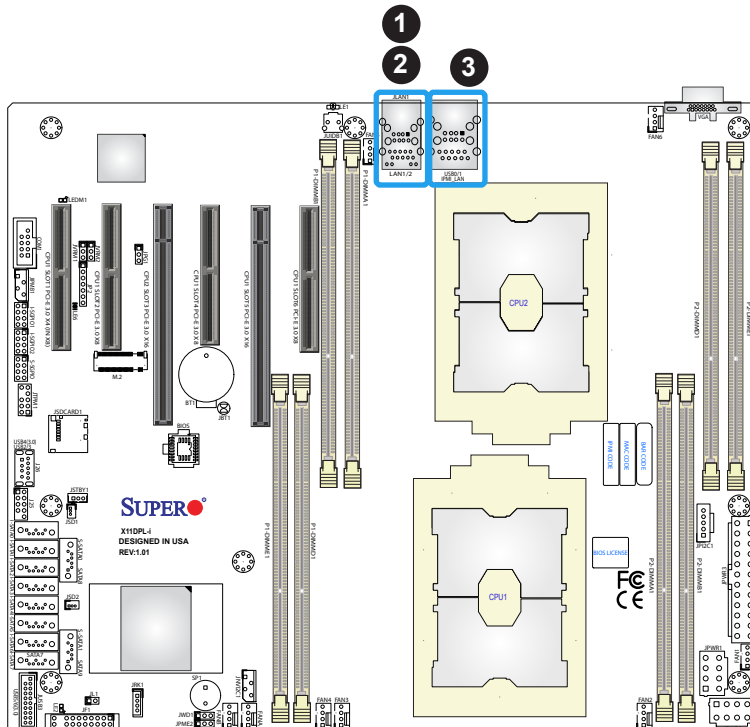

- 1. LAN2
- 2. LAN1
- 3. IPMI LAN

2.6 Front Control Panel

JF1 contains header pins for various buttons and indicators that are normally located on a control panel at the front of the chassis. These connectors are designed specifically for use with Supermicro chassis. See the figure below for the descriptions of the front control panel buttons and LED indicators.

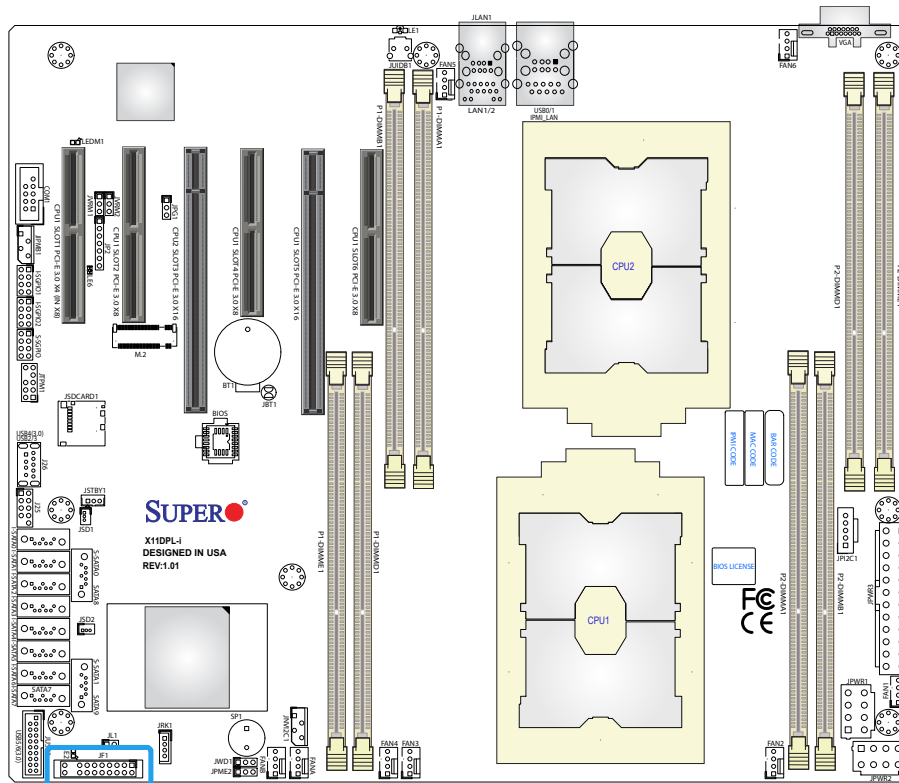

Figure 2-3. JF1 Header Pins

	1	2	
Power Button	PWR	○	Ground
Reset Button	Reset	○	Ground
	3.3V	○	Power Fail
UID LED	○	○	OH/Fan Fail LED
3.3V Stby	○	○	NIC2 Activity LED
3.3V Stby	○	○	NIC1 Activity LED
3.3V Stby	○	○	HDD LED
3.3V	○	○	Power LED
X	○	○	X
NMI	○	○	Ground
	19	20	

Power Button

The Power Button connection is located on pins 1 and 2 of JF1. Momentarily contacting both pins will power on/off the system. This button can also be configured to function as a suspend button (with a setting in the BIOS - see Chapter 4). To turn off the power when the system is in suspend mode, press the button for 4 seconds or longer. Refer to the table below for pin definitions.

Power Button Pin Definitions (JF1)	
Pins	Definition
1	Signal
2	Ground

Reset Button

The Reset Button connection is located on pins 3 and 4 of JF1. Attach it to a hardware reset switch on the computer case to reset the system. Refer to the table below for pin definitions.

Reset Button Pin Definitions (JF1)	
Pins	Definition
3	Reset
4	Ground

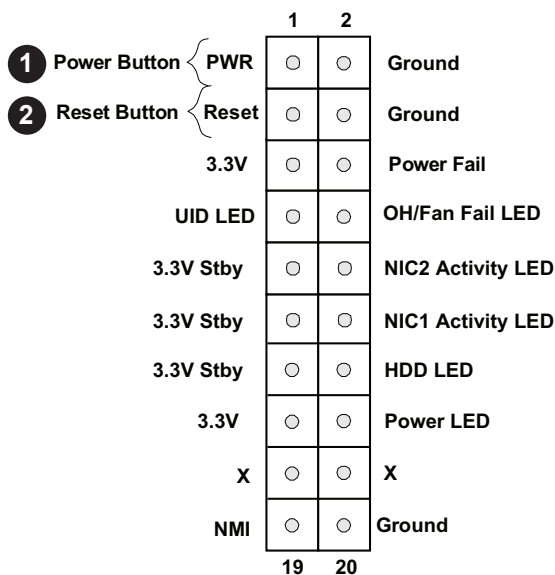

1. PWR Button
2. Reset Button

Power Fail LED

The Power Fail LED connection is located on pins 15 and 16 of JF1. Refer to the table below for pin definitions.

Power LED Pin Definitions (JF1)	
Pins	Definition
5	+3.3V
6	Power Fail LED

Fan Fail and UID LED

Connect an LED cable to pins 7 and 8 of the front control panel to use the Overheat/Fan Fail LED connections. The LED on pin 8 provides warnings of overheat or fan failure. Refer to the tables below for pin definitions.

OH/Fan Fail Indicator Status	
State	Definition
Off	Normal
On	Overheat
Flashing	Fan Fail

OH/Fan Fail LED Pin Definitions (JF1)	
Pin#	Definition
7	UID LED
8	OH/Fan Fail LED

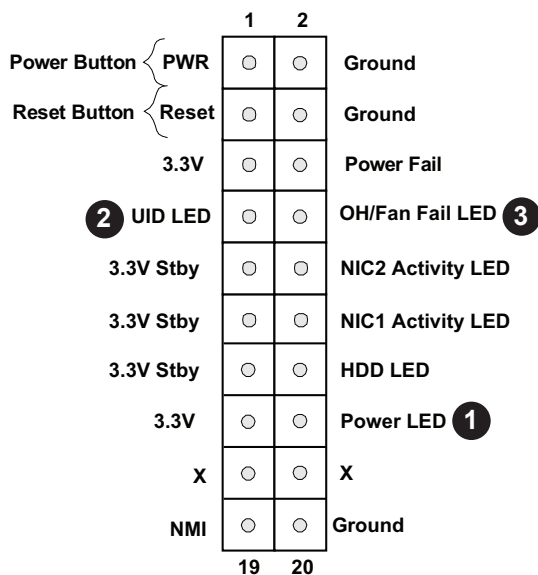

1. Power Fail LED
2. UID LED
3. OH/Fan Fail LED

NIC1/NIC2 (LAN1/LAN2)

The NIC (Network Interface Controller) LED connection for LAN port 1 is located on pins 11 and 12 of JF1, and the LED connection for LAN Port 2 is on pins 9 and 10. Attach NIC LED cables to NIC1 and NIC2 LED indicators to display network activities. Refer to the table below for pin definitions.

LAN1/LAN2 LED Pin Definitions (JF1)	
Pins	Definition
9/11	+3.3V Stby
10/12	NIC Activity LED

HDD LED

The HDD LED connection is located on pins 13 and 14 of JF1. Attach a cable to pin 14 to show hard drive activity status. Refer to the table below for pin definitions.

HDD LED Pin Definitions (JF1)	
Pins	Definition
13	3.3V Stdbby
14	HDD Active

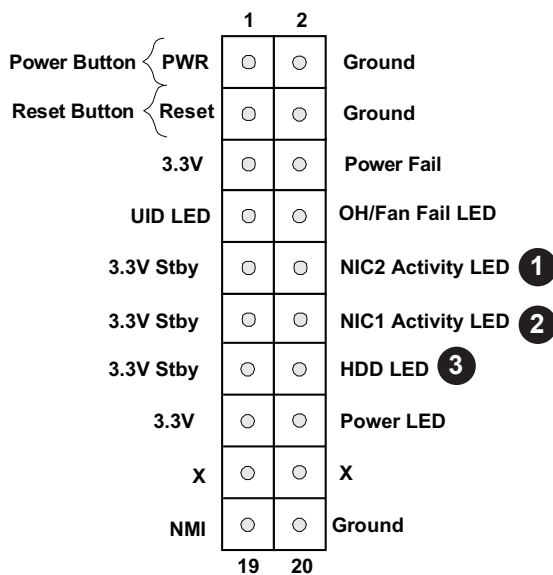

1. NIC2 LED
2. NIC1 LED
3. HDD LED

Power LED

The Power LED connection is located on pins 15 and 16 of JF1. Refer to the table below for pin definitions.

Power LED Pin Definitions (JF1)	
Pins	Definition
15	+3.3V
16	PWR LED

NMI Button

The non-maskable interrupt (NMI) button header is located on pins 19 and 20 of JF1. Refer to the table below for pin definitions.

NMI Button Pin Definitions (JF1)	
Pins	Definition
19	Control
20	Ground

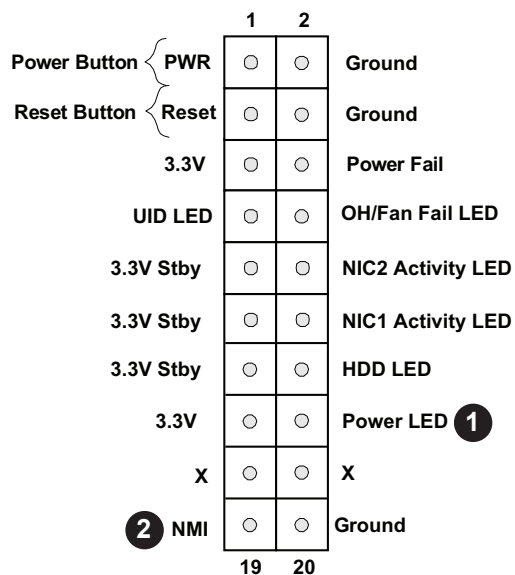

1. Power LED

2. NMI

2.7 Connectors

Power Connector

ATX and CPU Power Connectors

JPWR3 is the 24-pin ATX main power supply connector. This primary power supply connector meets the ATX SSI EPS 24-pin specification. You must also connect the 8-pin (JPWR1/JPWR2) CPU power connectors to your power supply.

ATX Power 24-pin Connector Pin Definitions			
Pin#	Definition	Pin#	Definition
13	+3.3V	1	+3.3V
14	NC	2	+3.3V
15	Ground	3	Ground
16	PS_ON	4	+5V
17	Ground	5	Ground
18	Ground	6	+5V
19	Ground	7	Ground
20	Res (NC)	8	PWR_OK
21	+5V	9	5VSB
22	+5V	10	+12V
23	+5V	11	+12V
24	Ground	12	+3.3V

Required Connection

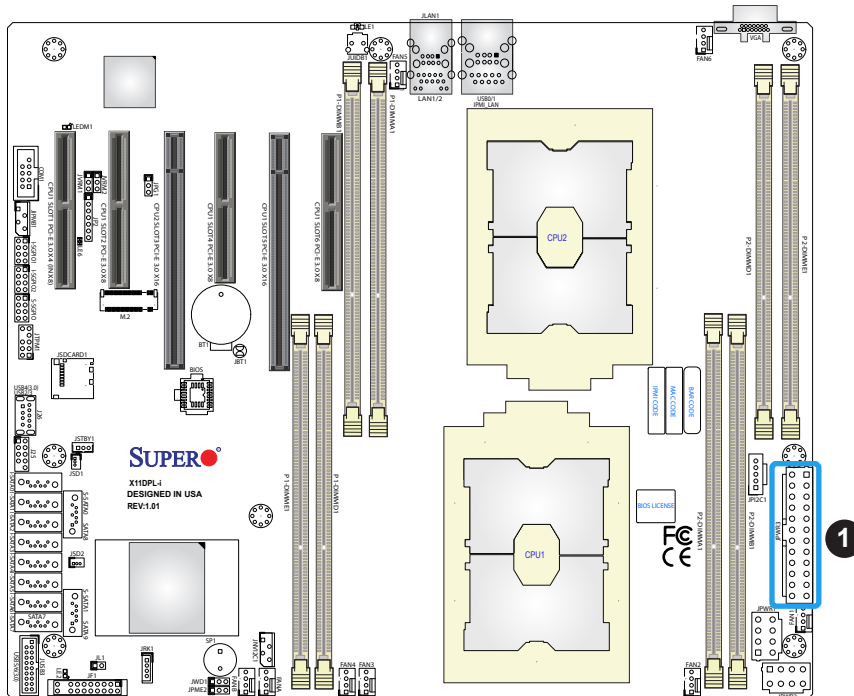

1. JPWR3 24-pin Power Supply

12V 8-pin CPU Power Connectors

JPWR1 and JPWR2 are the 8-pin 12V DC power input for the CPU or alternative single power source for a special enclosure when the 24-pin ATX power is not in use. Refer to the table below for pin definitions.

12V 8-pin Power Pin Definitions	
Pin#	Definition
1 - 4	Ground
5 - 8	+12V

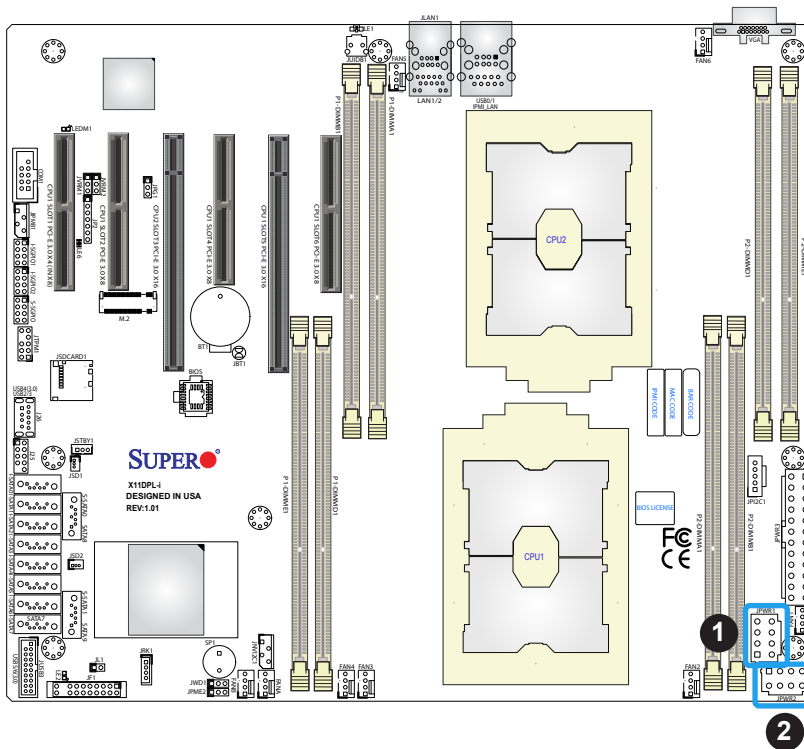

1. JPWR1
2. JPWR2

Headers

Onboard Fan Header

This motherboard has eight fan headers (FAN1~6, FANA, FANB). All these 4-pin fan headers are backward-compatible with traditional 3-pin fans. However, onboard fan speed control is available only when all 4-pin fans are used on the motherboard. Fan speed control is supported by Thermal Management via IPMI 2.0 interface. See the table below for pin definitions.

Fan Header Pin Definitions	
Pin#	Definition
1	Ground (Black)
2	+12V (Red)
3	Tachometer
4	PWM Control

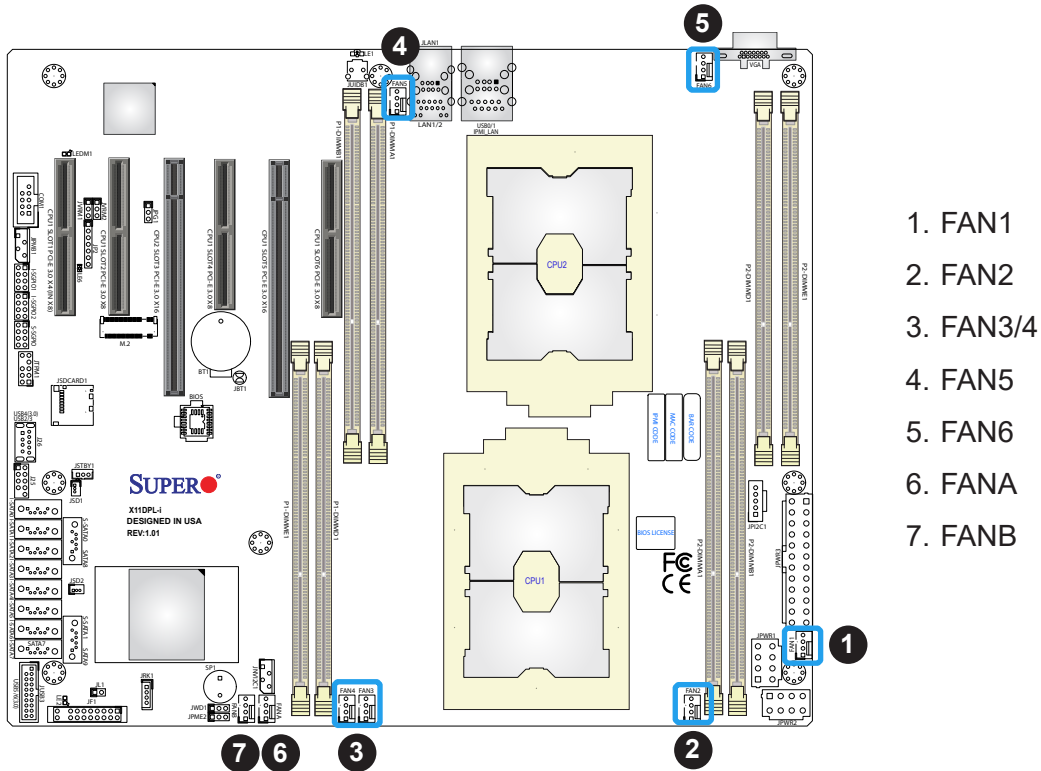

- 1. FAN1
- 2. FAN2
- 3. FAN3/4
- 4. FAN5
- 5. FAN6
- 6. FANA
- 7. FANB

TPM Header

The JTPM1 header is used to connect a Trusted Platform Module (TPM)/Port 80, which is available from a third-party vendor. A TPM/Port 80 connector is a security device that supports encryption and authentication in hard drives. It allows the motherboard to deny access if the TPM associated with the hard drive is not installed in the system. See the table below for pin definitions.

Trusted Platform Module/Port 80 Header Pin Definitions			
Pin#	Definition	Pin#	Definition
1	+3.3V	2	SPI_CS#
3	RESET#	4	SPI_MISO
5	SPI_CLK	6	GND
7	SPI_MOSI	8	
9	+3.3V Stdby	10	SPI_IRQ#

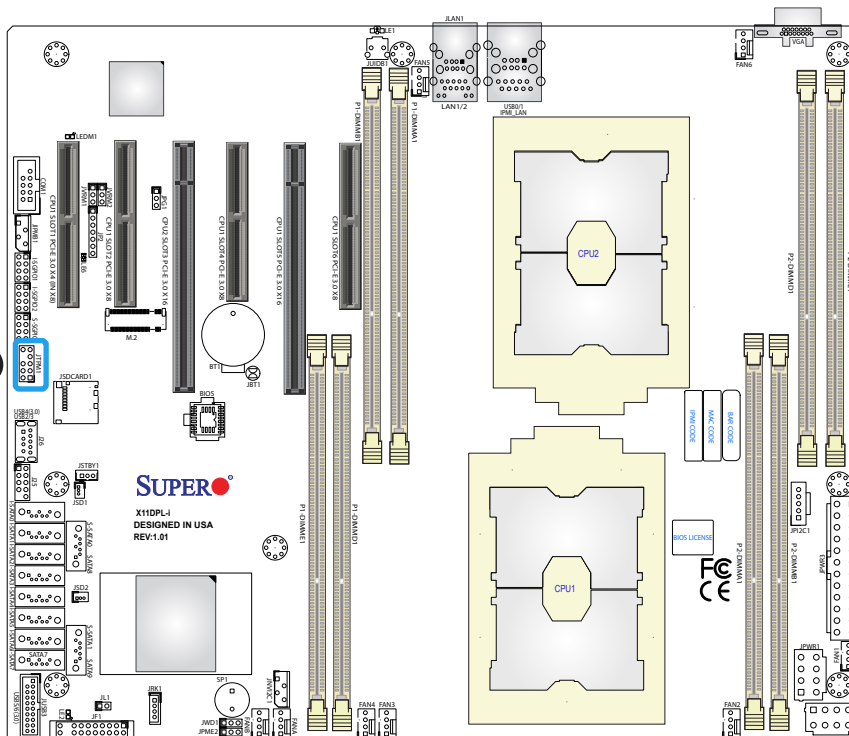

1. TPM/Port 80 Header

M.2-CPU1 Slot

The X11DPL-i motherboard has one M.2 slot that is supported by CPU1 (M.2-CPU1). M.2 was formerly Next Generation Form Factor (NGFF) and are used to replace mini PCI-E. M.2 supports a variety of card sizes with increased functionality and spatial efficiency. The M.2 socket on the motherboard supports PCI-E 3.0 X4 (32 Gb/s) SSD cards in the 2280 and 22110 form factors.

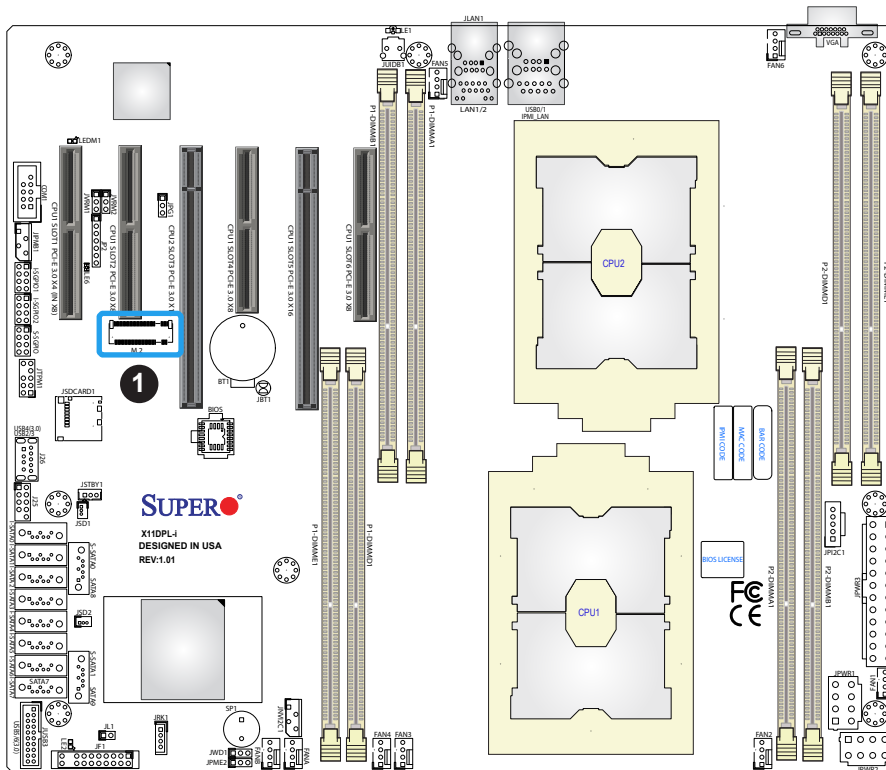
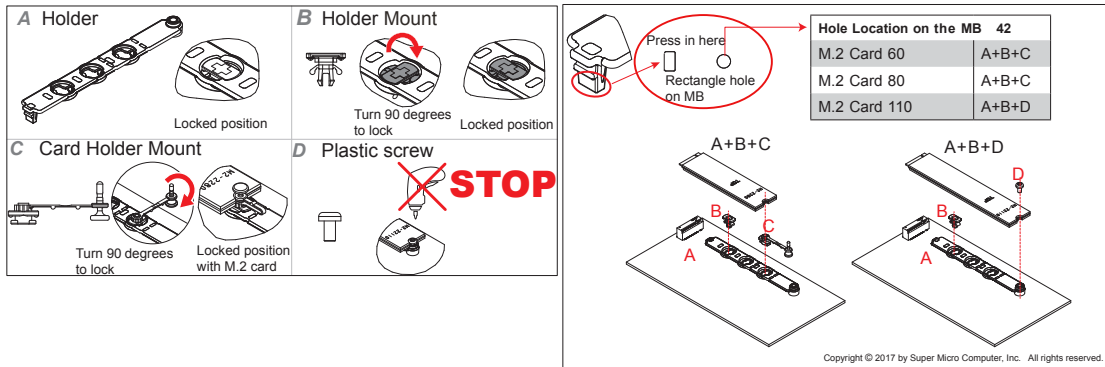

1. M.2 Slot

Chassis Intrusion

A Chassis Intrusion header is located at JL1 on the motherboard. Attach the appropriate cable from the chassis to inform you of a chassis intrusion when the chassis is opened. Refer to the table below for pin definitions.

Chassis Intrusion Pin Definitions	
Pin#	Definition
1	Intrusion Input
2	Ground

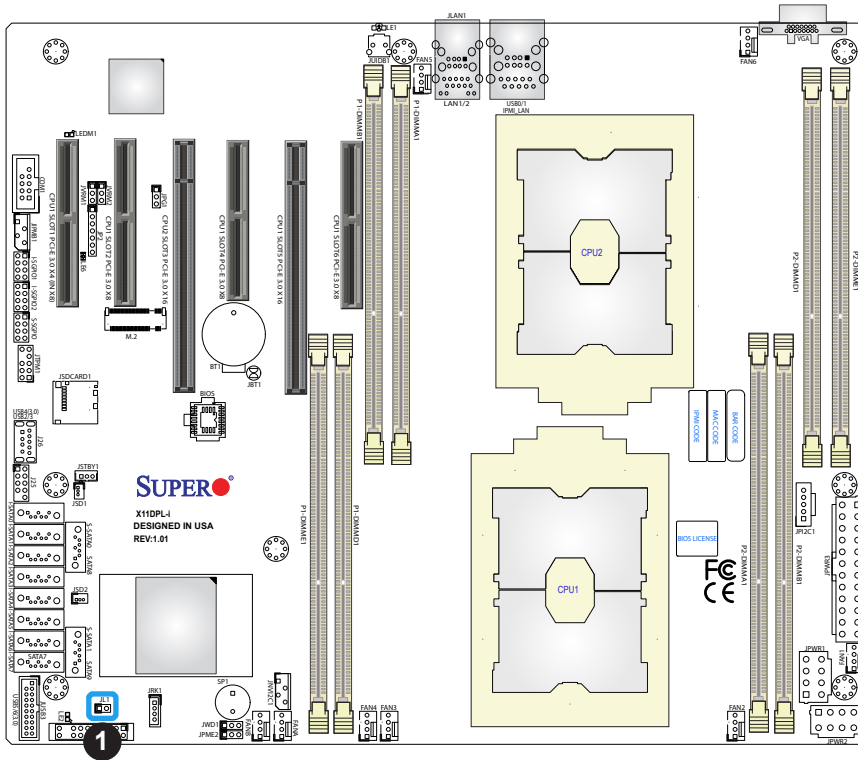

1. JL1

I-SATA 3.0 and S-SATA 3.0 Ports

The X11DPL-i has eight I-SATA 3.0 ports (I-SATA0~7) and two S-SATA 3.0 ports (S-SATA0/1) on the motherboard. These SATA ports are supported by the Intel C621 chipset. All these SATA ports provide serial-link signal connections, which are faster than the connections of Parallel ATA.

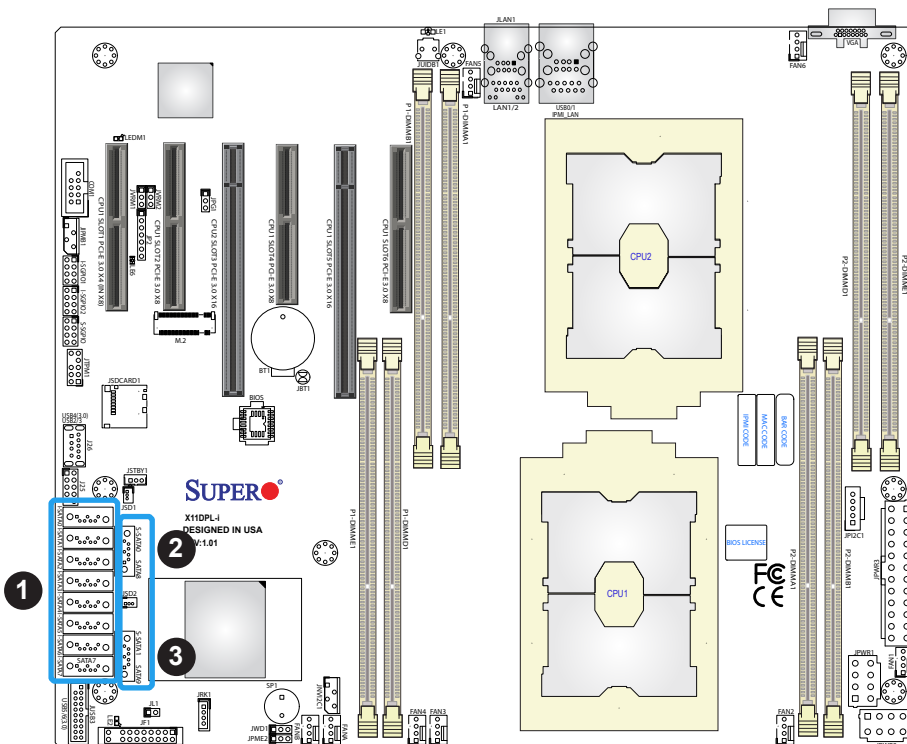

1. I-SATA0-7
2. S-SATA0
3. S-SATA1

2.8 Jumper Settings

How Jumpers Work

To modify the operation of the motherboard, jumpers can be used to choose between optional settings. Jumpers create shorts between two pins to change the function of the connector. Pin 1 is identified with a square solder pad on the printed circuit board. See the diagram at right for an example of jumping pins 1 and 2. Refer to the motherboard layout page for jumper locations.

 **Note:** On two-pin jumpers, "Closed" means the jumper is on and "Open" means the jumper is off the pins.

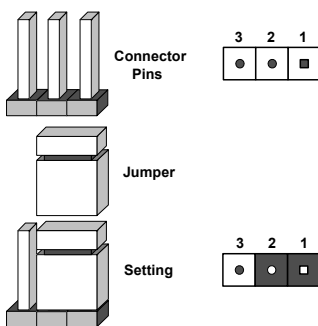

CMOS Clear

JBT1 is used to clear CMOS, which will also clear any passwords. Instead of pins, this jumper consists of contact pads to prevent accidentally clearing the contents of CMOS.

To Clear CMOS

1. First power down the system and unplug the power cord(s).
2. Remove the cover of the chassis to access the motherboard.
3. Remove the onboard battery from the motherboard.
4. Short the CMOS pads with a metal object such as a small screwdriver for at least four seconds.
5. Remove the screwdriver (or shorting device).
6. Replace the cover, reconnect the power cord(s), and power on the system.

 **Note:** Clearing CMOS will also clear all passwords.



Do not use the PW_ON connector to clear CMOS.

VGA Enable/Disable

JPG1 allows you to enable or disable the VGA port using the onboard graphics controller. The default setting is Enabled.

VGA Enable/Disable Jumper Settings	
Jumper Setting	Definition
Pins 1-2	Enabled
Pins 2-3	Disabled

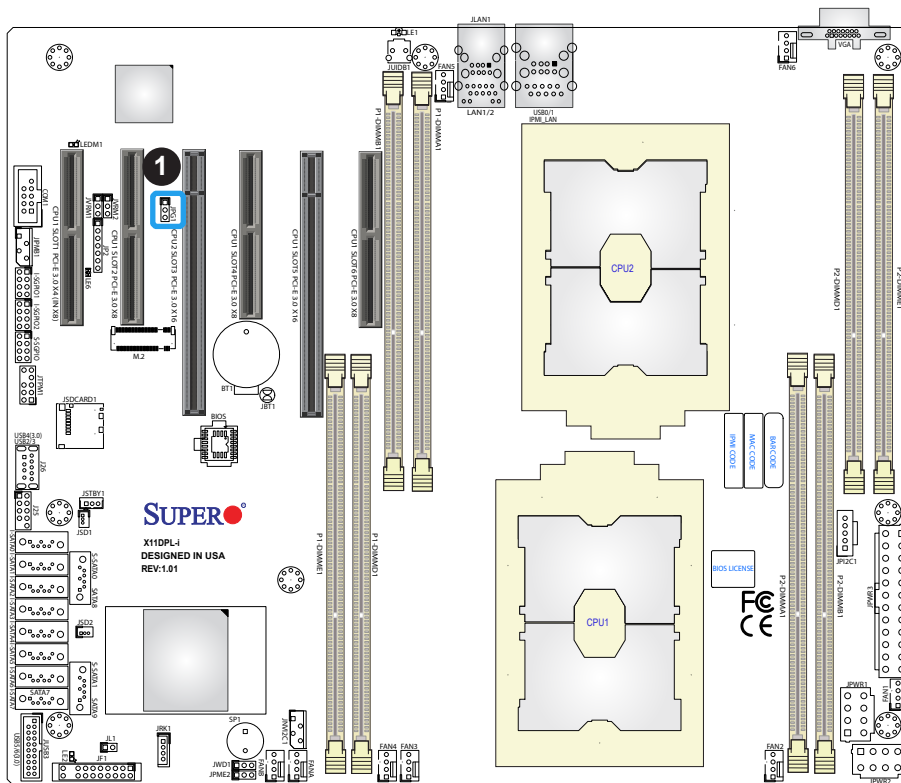

1. VGA Enable/Disable

Manufacturing Mode

Close JPME2 to bypass SPI flash security and force the system to use the Manufacturing Mode, which will allow you to flash the system firmware from a host server to modify system settings. See the table below for jumper settings.

Manufacturing Mode Select Jumper Settings	
Jumper Setting	Definition
Pins 1-2	Normal (Default)
Pins 2-3	Manufacturing Mode

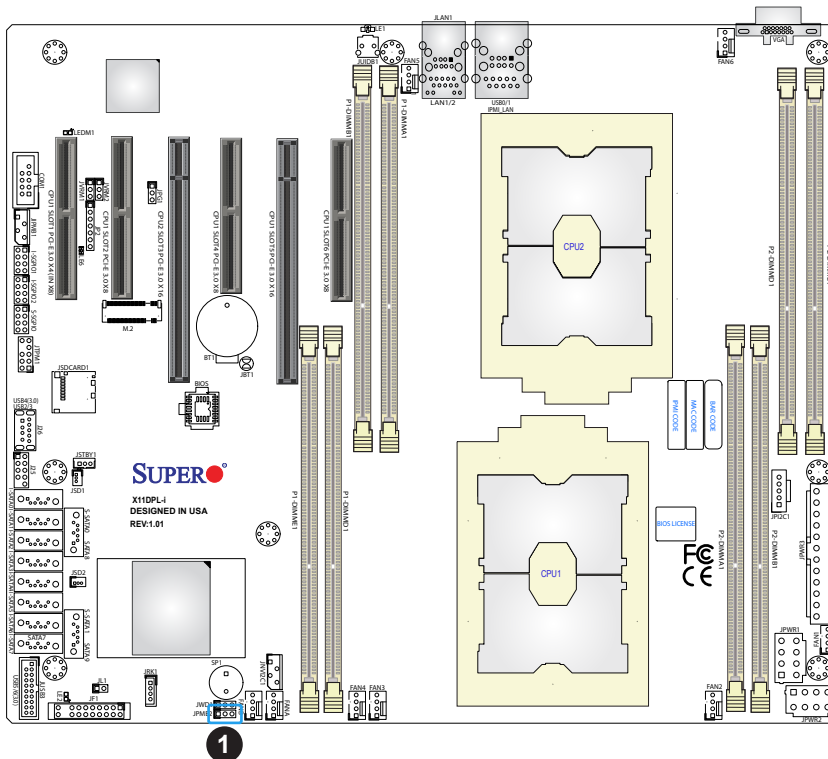

1. Manufacturing Mode

I²C Bus for VRM

Jumpers JVRM1 and JVRM2 allow the BMC or the PCH to access CPU and memory VRM controllers. See the table below for jumper settings.

VRM Jumper Settings		
Jumper	Jumper Setting	Definition
JVRM1	Pins 1-2	SMB Clock to BMC/PCH
JVRM2	Pins 1-2	SMB Data to BMC/PCH

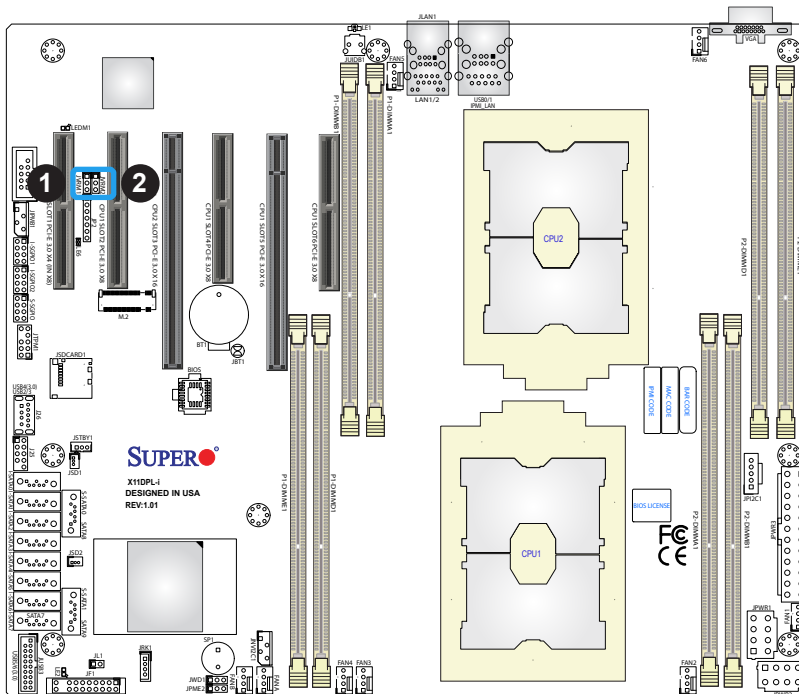

1. JVRM1
2. JVRM2

2.9 LED Indicators

IPMI LAN LEDs

A dedicated IPMI LAN, located on the back panel, has two LED indicators. The amber LED on the right of the IPMI LAN port indicates activity, while the LED on the left indicates the speed of the connection. See the table below for more information.

IPMI LAN

Link LED Activity LED



IPMI LAN LEDs		
	Color/State	Definition
Link (left)	Green: Solid	100 Mbps
	Amber: Solid	1Gbps
Activity (Right)	Amber: Blinking	Active

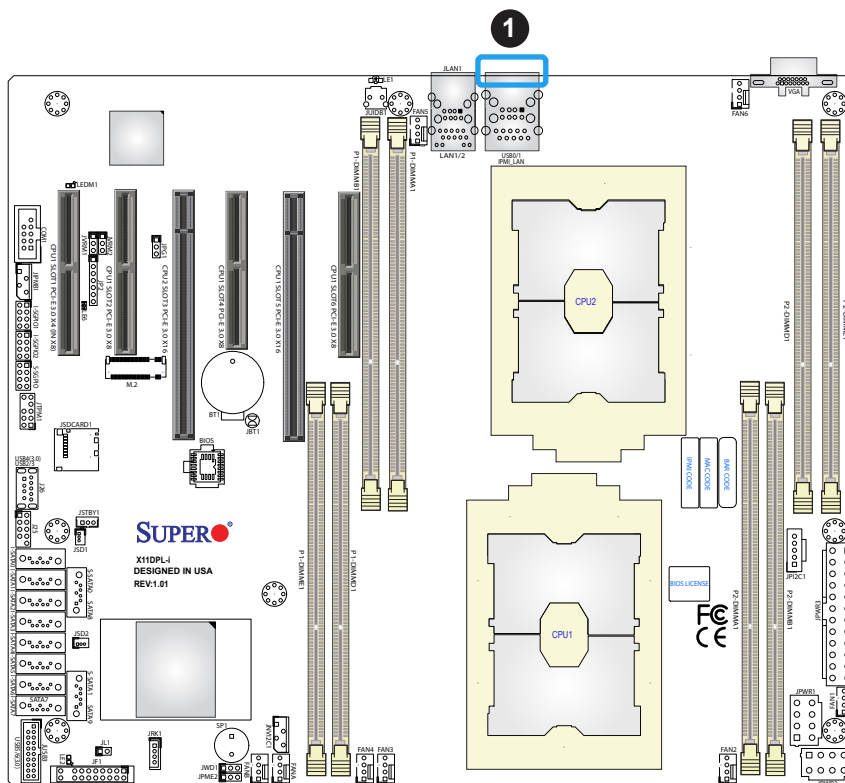

1. IPMI LAN LED

BMC Heartbeat LED

LEDM1 is the BMC heartbeat LED. When the LED is blinking green, BMC is functioning normally. See the table below for the LED status.

BMC Heartbeat LED Indicator	
LED Color	Definition
Green:	BMC Normal
Blinking	

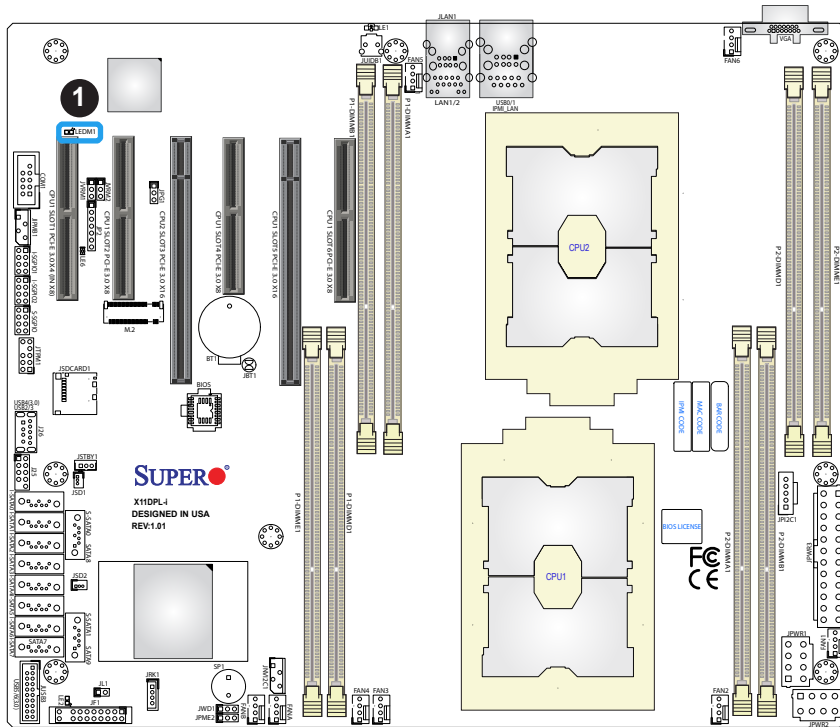

1. BMC Heartbeat LED

Unit ID LED

A rear UID LED indicator at UID_LED1 is located near the UID switch on the back panel. This UID indicator provides easy identification of a system unit that may need service.

UID LED LED Indicator	
LED Color	Definition
Blue: On	Unit Identified

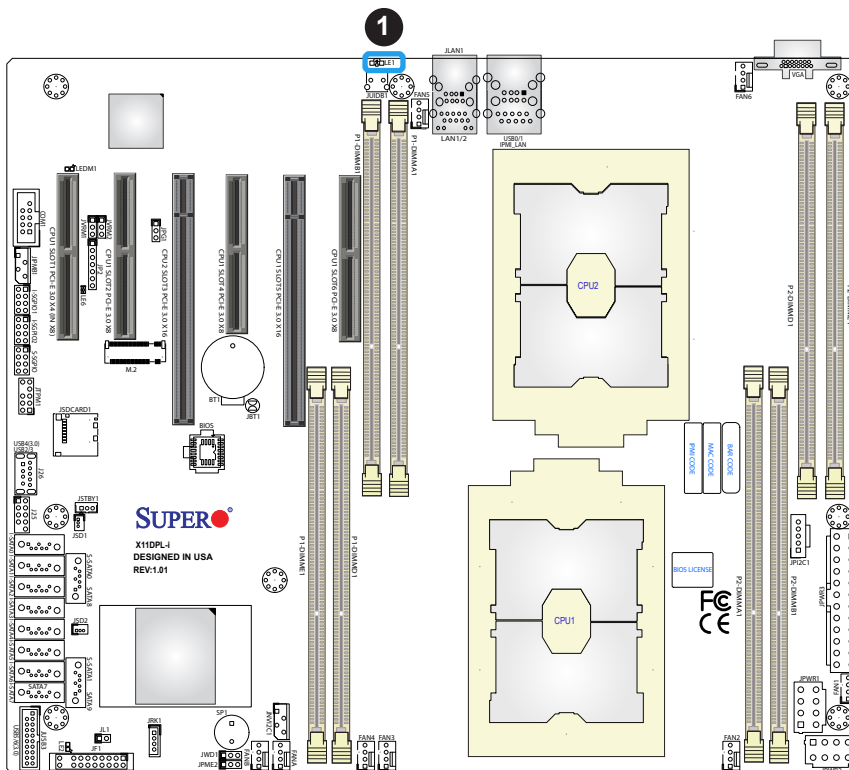

1. UID LED

2.10 PCI-E 3.0 Slots

PCI-E 3.0 Slots

There are several PCI-E slots located on the motherboard. Refer to the layout below for their locations.

1. PCI-E 3.0 x4 (in x8) (CPU1)
2. PCI-E 3.0 x8 (CPU1)
3. PCI-E 3.0 x16 (CPU2)
4. PCI-E 3.0 x8 (CPU1)
5. PCI-E 3.0 x16 (CPU1)
6. PCI-E 3.0 x8 (CPU1)

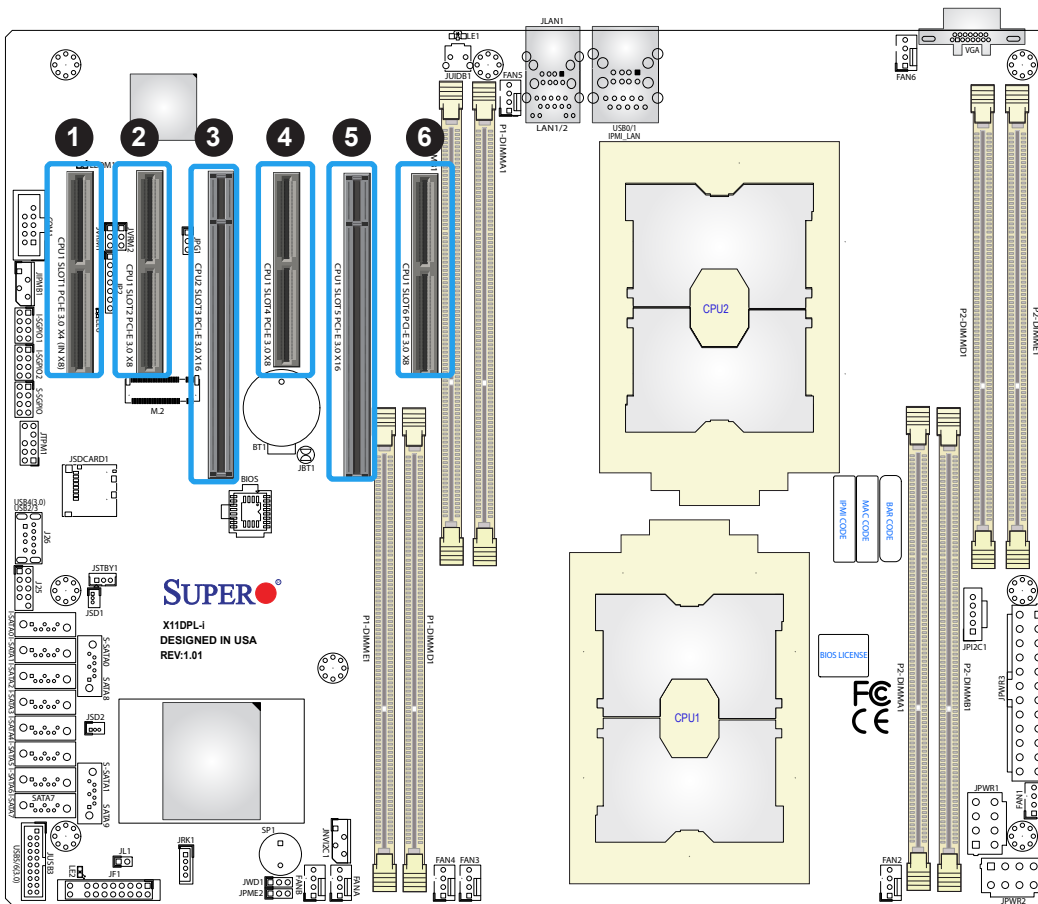

Chapter 3

Troubleshooting

3.1 Troubleshooting Procedures

Use the following procedures to troubleshoot your system. If you have followed all of the procedures below and still need assistance, refer to the 'Technical Support Procedures' and/or 'Returning Merchandise for Service' section(s) in this chapter. Always disconnect the AC power cord before adding, changing or installing any non hot-swap hardware components.

Before Power On

1. Check that the power LED on the motherboard is on.
2. Make sure that the power connector is connected to your power supply.
3. Make sure that no short circuits exist between the motherboard and chassis.
4. Disconnect all cables from the motherboard, including those for the keyboard and mouse.
5. Remove all add-on cards.
6. Install a CPU, a heatsink*, and connect the internal speaker and the power LED to the motherboard. Check all jumper settings as well. (Make sure that the heatsink is fully seated.)
7. Use the correct type of onboard CMOS battery (CR2032) as recommended by the manufacturer. To avoid possible explosion, do not install the CMOS battery upside down.

No Power

1. Make sure that no short circuits exist between the motherboard and the chassis.
2. Verify that all jumpers are set to their default positions.
3. Check that the 115V/230V switch on the power supply is properly set.
4. Turn the power switch on and off to test the system.
5. The battery on your motherboard may be old. Check to verify that it still supplies ~3VDC. If it does not, replace it with a new one.

No Video

1. If the power is on but you have no video, remove all the add-on cards and cables.
2. Use the speaker to determine if any beep codes exist. Refer to Appendix A for details on beep codes.

System Boot Failure

If the system does not display POST (Power-On-Self-Test) or does not respond after the power is turned on, check the following:

1. Check for any error beep from the motherboard speaker.
 - If there is no error beep, try to turn on the system without DIMM modules installed. If there is still no error beep, replace the motherboard.
 - If there are error beeps, clear the CMOS settings by unplugging the power cord and contacting both pads on the CMOS Clear Jumper (JBT1). Refer to chapter 2.
2. Remove all components from the motherboard, especially the DIMM modules. Make sure that system power is on and that memory error beeps are activated.
3. Turn on the system with only one DIMM module installed. If the system boots, check for bad DIMM modules or slots by following the Memory Errors Troubleshooting procedure in this Chapter.

Memory Errors

1. Make sure that the DIMM modules are properly and fully installed.
2. Confirm that you are using the correct memory. Also, it is recommended that you use the same memory type and speed for all DIMMs in the system. See Section 2.4 for memory details.
3. Check for bad DIMM modules or slots by swapping modules between slots and noting the results.
4. Check the power supply voltage 115V/230V switch.

Losing the System's Setup Configuration

1. Make sure that you are using a high quality power supply. A poor quality power supply may cause the system to lose the CMOS setup information. Refer to Section 1.6 for details on recommended power supplies.
2. The battery on your motherboard may be old. Check to verify that it still supplies ~3VDC. If it does not, replace it with a new one.
3. If the above steps do not fix the setup configuration problem, contact your vendor for repairs.

When the System Becomes Unstable

A. If the system becomes unstable during or after OS installation, check the following:

1. CPU/BIOS support: Make sure that your CPU is supported and that you have the latest BIOS installed in your system.
2. Memory support: Make sure that the memory modules are supported by testing the modules using memtest86 or a similar utility.



Note: Refer to the product page on our website at <http://www.supermicro.com> for memory and CPU support and updates.

3. HDD support: Make sure that all hard disk drives (HDDs) work properly. Replace the bad HDDs with good ones.
4. System cooling: Check the system cooling to make sure that all heatsink fans and CPU/system fans, etc., work properly. Check the hardware monitoring settings in the IPMI to make sure that the CPU and system temperatures are within the normal range. Also check the front panel Overheat LED and make sure that it is not on.
5. Adequate power supply: Make sure that the power supply provides adequate power to the system. Make sure that all power connectors are connected. Please refer to our website for more information on the minimum power requirements.
6. Proper software support: Make sure that the correct drivers are used.

B. If the system becomes unstable before or during OS installation, check the following:

1. Source of installation: Make sure that the devices used for installation are working properly, including boot devices such as CD.
2. Cable connection: Check to make sure that all cables are connected and working properly.

3. Using the minimum configuration for troubleshooting: Remove all unnecessary components (starting with add-on cards first), and use the minimum configuration (but with a CPU and a memory module installed) to identify the trouble areas. Refer to the steps listed in Section A above for proper troubleshooting procedures.
4. Identifying bad components by isolating them: If necessary, remove a component in question from the chassis, and test it in isolation to make sure that it works properly. Replace a bad component with a good one.
5. Check and change one component at a time instead of changing several items at the same time. This will help isolate and identify the problem.
6. To find out if a component is good, swap this component with a new one to see if the system will work properly. If so, then the old component is bad. You can also install the component in question in another system. If the new system works, the component is good and the old system has problems.

3.2 Technical Support Procedures

Before contacting Technical Support, please take the following steps. Also, note that as a motherboard manufacturer, we do not sell directly to end-users, so it is best to first check with your distributor or reseller for troubleshooting services. They should know of any possible problem(s) with the specific system configuration that was sold to you.

1. Please review the 'Troubleshooting Procedures' and 'Frequently Asked Questions' (FAQs) sections in this chapter or see the FAQs on our website before contacting Technical Support.
2. BIOS upgrades can be downloaded from our website. **Note:** Not all BIOS can be flashed depending on the modifications to the boot block code.
3. If you still cannot resolve the problem, include the following information when contacting us for technical support:
 - Motherboard model and PCB revision number
 - BIOS release date/version (this can be seen on the initial display when your system first boots up)
 - System configuration

An example of a Technical Support form is posted on our website.

Distributors: For immediate assistance, please have your account number ready when contacting our technical support department by e-mail.

3.3 Frequently Asked Questions

Question: What type of memory does my motherboard support?

Answer: The X11DPL-i motherboard supports up to 1TB of 3DS LRDIMM/LRDIMM/RDIMM/NV-DIMM DDR4 ECC 2666/2400/2133 MHz memory in 8 memory slots. See Section 2.4 for details on installing memory.

Question: How do I update my BIOS?

Answer: It is recommended that you **do not** upgrade your BIOS if you are not experiencing any problems with your system. Updated BIOS files are located on our website at <http://www.supermicro.com>. Please check our BIOS warning message and the information on how to update your BIOS on our website. Select your motherboard model and download the BIOS file to your computer. Also, check the current BIOS revision to make sure that it is newer than your BIOS before downloading. You can choose from the zip file and the .exe file. If you choose the zip BIOS file, please unzip the BIOS file onto a bootable USB device. Run the batch file using the format FLASH.BAT filename.rom from your bootable USB device to flash the BIOS. Then, your system will automatically reboot.

Question: Why can't I turn off the power using the momentary power on/off switch?

Answer: The instant power off function is controlled in BIOS by the Power Button Mode setting. When the On/Off feature is enabled, the motherboard will have instant off capabilities as long as the BIOS has control of the system. When the Standby or Suspend feature is enabled or when the BIOS is not in control such as during memory count (the first screen that appears when the system is turned on), the momentary on/off switch must be held for more than four seconds to shut down the system. This feature is required to implement the ACPI features on the motherboard.

3.4 Battery Removal and Installation

Battery Removal

To remove the onboard battery, follow the steps below:

1. Power off your system and unplug your power cable.
2. Locate the onboard battery as shown below.
3. Using a tool such as a pen or a small screwdriver, push the battery lock outwards to unlock it. Once unlocked, the battery will pop out from the holder.
4. Remove the battery.

Proper Battery Disposal

Please handle used batteries carefully. Do not damage the battery in any way; a damaged battery may release hazardous materials into the environment. Do not discard a used battery in the garbage or a public landfill. Please comply with the regulations set up by your local hazardous waste management agency to dispose of your used battery properly.

Battery Installation

1. To install an onboard battery, follow the steps 1 & 2 above and continue below:
2. Identify the battery's polarity. The positive (+) side should be facing up.
3. Insert the battery into the battery holder and push it down until you hear a click to ensure that the battery is securely locked.



Important: When replacing a battery, be sure to only replace it with the same type.

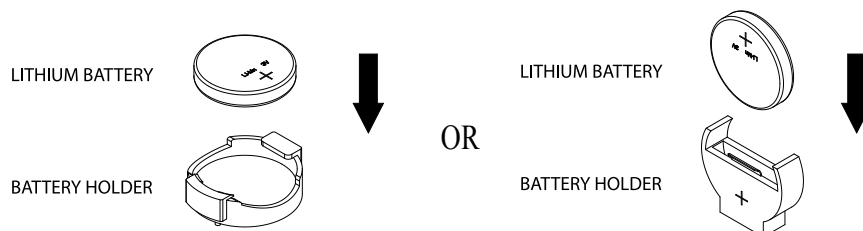

3.5 Returning Merchandise for Service

A receipt or copy of your invoice marked with the date of purchase is required before any warranty service will be rendered. You can obtain service by calling your vendor for a Returned Merchandise Authorization (RMA) number. When returning to the manufacturer, the RMA number should be prominently displayed on the outside of the shipping carton and mailed prepaid or hand-carried. Shipping and handling charges will be applied for all orders that must be mailed when service is complete.

For faster service, RMA authorizations may be requested online (<http://www.supermicro.com/support/rma/>).

This warranty only covers normal consumer use and does not cover damages incurred in shipping or from failure due to the alteration, misuse, abuse or improper maintenance of products.

During the warranty period, contact your distributor first for any product problems.

Chapter 4

BIOS

4.1 Introduction

This chapter describes the AMIBIOS™ Setup utility for the motherboard. The BIOS is stored on a chip and can be easily upgraded using a flash program.



Note: Due to periodic changes to the BIOS, some settings may have been added or deleted and might not yet be recorded in this manual. Please refer to the Manual Download area of our website for any changes to BIOS that may not be reflected in this manual.

Starting the Setup Utility

To enter the BIOS Setup Utility, hit the <Delete> key while the system is booting-up. (In most cases, the <Delete> key is used to invoke the BIOS setup screen. There are a few cases when other keys are used, such as <F1>, <F2>, etc.) Each main BIOS menu option is described in this manual.

The Main BIOS screen has two main frames. The left frame displays all the options that can be configured. “Grayed-out” options cannot be configured. The right frame displays the key legend. Above the key legend is an area reserved for a text message. When an option is selected in the left frame, it is highlighted in white. Often a text message will accompany it. (Note that BIOS has default text messages built in. We retain the option to include, omit, or change any of these text messages.) Settings printed in **Bold** are the default values.

A " ►" indicates a submenu. Highlighting such an item and pressing the <Enter> key will open the list of settings within that submenu.

The BIOS setup utility uses a key-based navigation system called hot keys. Most of these hot keys (<F1>, <F2>, <F3>, <Enter>, <ESC>, <Arrow> keys, etc.) can be used at any time during the setup navigation process.

4.2 Main Setup

When you first enter the AMI BIOS setup utility, you will enter the Main setup screen. You can always return to the Main setup screen by selecting the Main tab on the top of the screen. The Main BIOS setup screen is shown below. The following Main menu items will be displayed:

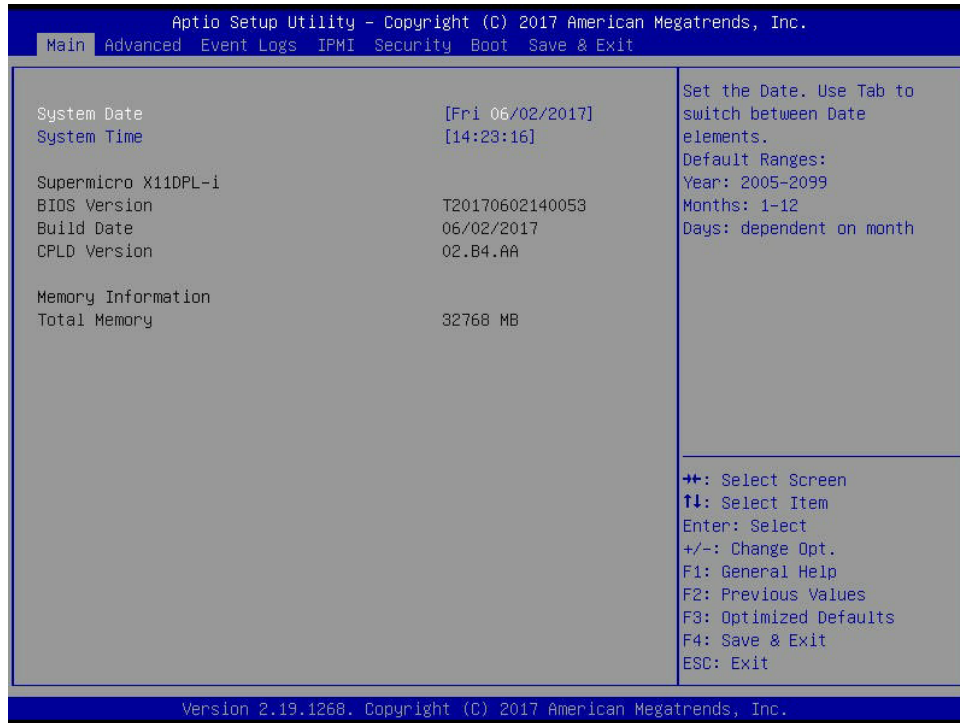

System Date/System Time

Use this option to change the system date and time. Highlight *System Date* or *System Time* using the arrow keys. Enter new values using the keyboard. Press the <Tab> key or the arrow keys to move between fields. The date must be entered in MM/DD/YYYY format. The time is entered in HH:MM:SS format.

 **Note:** The time is in the 24-hour format. For example, 5:30 P.M. appears as 17:30:00. The date's default value is 01/01/2015 after RTC reset.

Supermicro X11DPL-i

BIOS Version

This item displays the version of the BIOS ROM used in the system.

Build Date

This item displays the date when the version of the BIOS ROM used in the system was built.

Memory Information

Total Memory

This item displays the total size of memory available in the system.

4.3 Advanced Setup Configurations

Use the arrow keys to select Boot Setup and press <Enter> to access the submenu items.

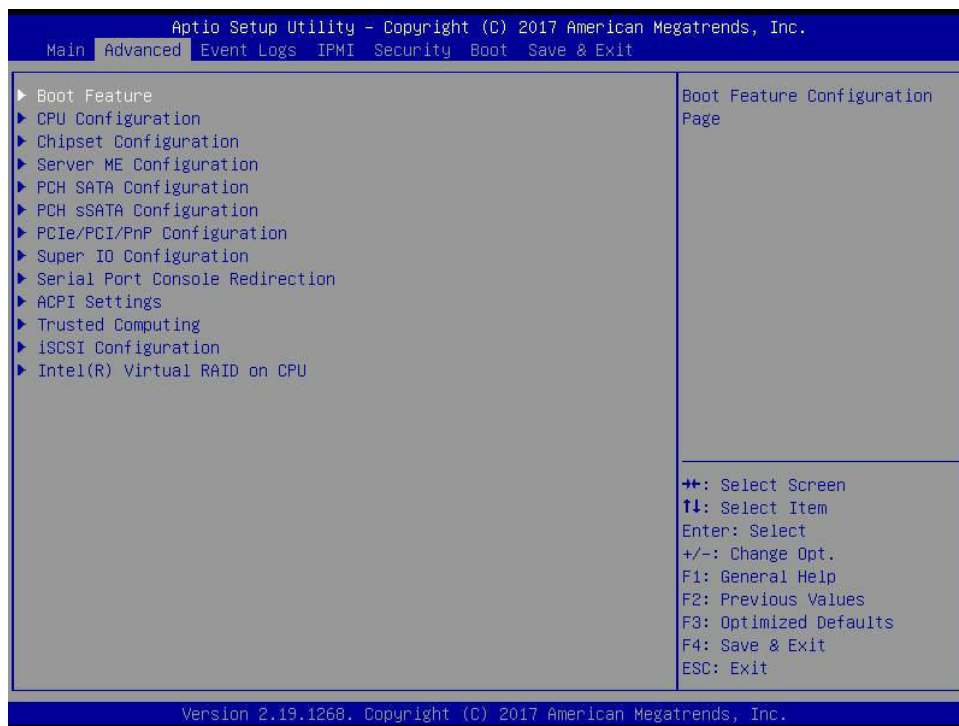

Warning: Take caution when changing the Advanced settings. An incorrect value, a very high DRAM frequency, or an incorrect DRAM timing setting may make the system unstable. When this occurs, revert to the default to the manufacture default settings.

► Boot Feature

Quiet Boot

Use this feature to select the screen display between the POST messages and the OEM logo upon bootup. Select Disabled to display the POST messages. Select Enabled to display the OEM logo instead of the normal POST messages. The options are Disabled and **Enabled**.

Option ROM Messages

Use this feature to set the display mode for the Option ROM. Select Keep Current to display the current AddOn ROM setting. Select Force BIOS to use the Option ROM display set by the system BIOS. The options are **Force BIOS** and Keep Current.

Bootup NumLock State

Use this feature to set the Power-on state for the <Numlock> key. The options are **On** and Off.

Wait For "F1" If Error

Use this feature to force the system to wait until the 'F1' key is pressed if an error occurs. The options are Disabled and **Enabled**.

INT19 (Interrupt 19) Trap Response

Interrupt 19 is the software interrupt that handles the boot disk function. When this item is set to Immediate, the ROM BIOS of the host adaptors will "capture" Interrupt 19 at bootup immediately and allow the drives that are attached to these host adaptors to function as bootable disks. If this item is set to Postponed, the ROM BIOS of the host adaptors will not capture Interrupt 19 immediately and allow the drives attached to these adaptors to function as bootable devices at bootup. The options are **Immediate** and Postponed.

Re-try Boot

If this item is enabled, the BIOS will automatically reboot the system from a specified boot device after its initial boot failure. The options are **Disabled**, Legacy Boot, and EFI Boot.

Install Windows 7 USB Support

Enable this feature to use the USB keyboard and mouse during the Windows 7 installation, since the native XHCI driver support is unavailable. Use a SATA optical drive as a USB drive, and USB CD/DVD drives are not supported. Disable this feature after the XHCI driver has been installed in Windows. The options are **Disabled** and Enabled.

Port 61h Bit-4 Emulation

Select Enabled to enable the emulation of Port 61h bit-4 toggling in SMM (System Management Mode). The options are **Disabled** and Enabled.

►Power Configuration**Watch Dog Function**

If enabled, the Watch Dog Timer will allow the system to reset or generate NMI based on jumper settings when it is expired for more than five minutes. The options are **Disabled** and Enabled.

Restore on AC Power Loss

Use this feature to set the power state after a power outage. Select Stay Off for the system power to remain off after a power loss. Select Power On for the system power to be turned on after a power loss. Select Last State to allow the system to resume its last power state before a power loss. The options are Stay Off, Power On, and **Last State**.

Power Button Function

This feature controls how the system shuts down when the power button is pressed. Select 4 Seconds Override for the user to power off the system after pressing and holding the power button for 4 seconds or longer. Select Instant Off to instantly power off the system as soon as the user presses the power button. The options are **Instant Off** and 4 Seconds Override.

Throttle on Power Fail

This feature allows the system to decrease system power requirements by throttling CPU frequency in the event of one power supply failing.

► CPU Configuration

Processor Configuration

The following CPU information will display:

- Processor BSP Revision
- Processor Socket
- Processor ID
- Processor Frequency
- Processor Max Ratio
- Processor Min Ratio
- Microcode Revision
- L1 Cache RAM
- L2 Cache RAM
- L3 Cache RAM
- Processor 0 Version
- Processor 1 Version

Hyper-Threading (ALL) (Available when supported by the CPU)

Select Enable to support Intel Hyper-threading Technology to enhance CPU performance. The options are Disable and **Enable**.

Execute Disable Bit (Available if supported by the OS & the CPU)

Select Enabled to enable the Execute-Disable Bit which will allow the processor to designate areas in the system memory where an application code can execute and where it cannot, thus preventing a worm or a virus from flooding illegal codes to overwhelm the processor or damage the system during an attack. The default is **Enable**. (Refer to the Intel® and Microsoft® websites for more information.)

Intel Virtualization Technology

Use feature to enable the Vanderpool Technology. This technology allows the system to run several operating systems simultaneously. The options are Disable and **Enable**.

PPIN Control

Select Unlock/Enable to use the Protected-Processor Inventory Number (PPIN) in the system. The options are Unlock/Disable and **Unlock/Enable**

Hardware Prefetcher (Available when supported by the CPU)

If set to Enabled, the hardware prefetcher will prefetch streams of data and instructions from the main memory to the L2 cache to improve CPU performance. The options are Disable and **Enable**.

Adjacent Cache Prefetch (Available when supported by the CPU)

The CPU prefetches the cache line for 64 bytes if this feature is set to Disabled. The CPU prefetches both cache lines for 128 bytes as comprised if this feature is set to **Enable**.

DCU Streamer Prefetcher (Available when supported by the CPU)

Select Enabled to enable the DCU (Data Cache Unit) Streamer Prefetcher which will stream and prefetch data and send it to the Level 1 data cache to improve data processing and system performance. The options are Disable and **Enable**.

DCU IP Prefetcher (Available when supported by the CPU)

Select Enabled for DCU (Data Cache Unit) IP Prefetcher support, which will prefetch IP addresses to improve network connectivity and system performance. The options are **Enable** and Disable.

LLC Prefetch

If set to Enabled, the hardware prefetcher will prefetch streams of data and instructions from the main memory to the L3 cache to improve CPU performance. The options are Disable and **Enable**.

Extended APIC

Select Enable to activate APIC (Advanced Programmable Interrupt Controller) support. The options are Disable and **Enable**.

AES-NI

Select Enable to use the Intel Advanced Encryption Standard (AES) New Instructions (NI) to ensure data security. The options are Disable and **Enable**.

► Advanced Power Management Configuration

► CPU P State Control

This feature allows the user to configure the following CPU power settings

Speedstep (Pstates)

Intel SpeedStep Technology allows the system to automatically adjust processor voltage and core frequency to reduce power consumption and heat dissipation. The options are Disabled and **Enabled**.

EIST PSD Funtion

This feature allows the user to choose between Hardware and Software to control the processor's frequency and performance (P-state). In HW_ALL mode, the processor hardware is responsible for coordinating the P-state, and the OS is responsible for keeping the P-state request up to date on all logical processors. In SW_ALL mode, the OS Power Manager is responsible for coordinating the P-state, and must initiate the transition on all Logical Processors. In SW_ANY mode, the OS Power Manager is responsible for coordinating the P-state and may initiate the transition on any Logical Processors.

Options available: HW_ALL/SW_ALL/SW_ANY. Default setting is HW_ALL.

Turbo Mode

This feature will enable dynamic control of the processor, allowing it to run above stock frequency.

► Hardware PM State Control

Hardware P-States

This setting allows the user to select between OS and hardware-controlled P-states. Selecting Native Mode allows the OS to choose a P-state. Selecting Out of Band Mode allows the hardware to autonomously choose a P-state without OS guidance. Selecting Native Mode with No Legacy Support functions as Native Mode with no support for older hardware.

► CPU C State Control

Autonomous Core C-State

Enabling this setting allows the hardware to autonomously choose to enter a C-state based on power consumption and clock speed.

CPU C6 Report

Select Enabled to allow the BIOS to report the CPU C6 State (ACPI C3) to the operating system. During the CPU C6 State, the power to all cache is turned off. The options are Disable and **Enable**.

Enhanced Halt State (C1E)

Select Enabled to use Enhanced Halt-State technology, which will significantly reduce the CPU's power consumption by reducing the CPU's clock cycle and voltage during a Halt-state. The options are Disable and **Enable**.

► Package C State Control

Package C State

This feature allows the user to set the limit on the C State package register. The options are C0/C1 State, C2 State, C6 (Non Retention) State, C6 (Retention) state, No Limit, and **Auto**.

► CPU T State Control

Software Controlled T-States

Enabling this feature allows the OS to choose a T-State. The options are Enable and **Disable**.

► Chipset Configuration

Warning: Setting the wrong values in the following features may cause the system to malfunction.

► North Bridge

This feature allows the user to configure the following North Bridge settings.

► UPI Configuration

► UPI General Configuration

UPI Status

The following UPI information will display:

- Number of CPU
- Number of IIO
- Current UPI Link Speed

- Current UPI Link Frequency
- UPI Global MMIO Low Base / Limit
- UPI Global MMIO High Base / Limit
- UPI Pci-e Configuration Base / Size

Degrade Precedence

Use this feature to set degrade precedence when system settings are in conflict. Select Topology Precedence to degrade Features. Select Feature Precedence to degrade Topology. The options are Topology Precedence and Feature Precedence. Link L0p Enable Select Enable for Link L0p support. The options are **Enable** and Disable.

Link L1 Enable

Select Enable for Link L1 support. The options are **Enable** and Disable.

IO Directory Cache (IODC)

IO Directory Cache is an 8-entry cache that stores the directory state of remote IIO writes and memory lookups, and saves directory updates. Use this feature to lower cache to cache (C2C) transfer latencies. The options are Disable, **Auto**, Enable for Remote InvltoM Hybrid Push, InvltoM AllocFlow, Enable for Remote InvltoM Hybrid AllocNonAlloc, and Enable for Remote InvltoM and Remote WViLF.

Isoc Mode

Select Enabled for Isochronous support to meet QoS (Quality of Service) requirements. This feature is especially important for Virtualization Technology. The options are Enable and **Disable**.

► Memory Configuration

Enforce POR

Select Enable to enforce POR restrictions on DDR4 frequency and voltage programming. The options are **Enabled** and Disable.

Memory Frequency

Use this feature to set the maximum memory frequency for onboard memory modules. The options are **Auto**, 1333, 1400, 1600, 1800, 1867, 2000, 2133, 2200, and 2400.

Data Scrambling for NVDIMM

Use this feature to enable or disable data scrambling for non-volatile DIMM (NVDIMM) memory. The options are **Auto**, Disable, and Enable.

Data Scrambling for DDR4

Use this feature to enable or disable data scrambling for DDR4 memory. The options are **Auto**, **Disable**, and **Enable**.

tCCD_L Relaxation

If Enabled, the tCCD_L overrides the SPD. When disabled, it is enforced based on memory frequency. The options are **Enable** and **Disable**.

Enable ADR

Select **Enable** for ADR (Automatic Diagnostic Repository) support to enhance memory performance. The options are **Disable** and **Enable**.

2X REFRESH

This option allows the user to select 2X refresh mode. The options are **Auto**, **Enabled**, and **Disabled**.

►Memory Topology

This feature displays DIMM population information.

►Memory RAS Configuration

Static Virtual Lockstep Mode

Select **Enable** to run the system's memory channels in lockstep mode to minimize memory access latency. The options are **Disable** and **Enable**.

Mirror Mode

This feature allows memory to be mirrored between two channels, providing 100% redundancy. The options are **Disable**, **Mirror Mode 1LM**, and **Mirror Mode 2LM**.

UEFI ARM Mirror

This options allows the system to imitate the behavior of the UEFI based Address Range Mirror with setup option. The options are **Disable** and **Enable**.

Memory Rank Sparing

Select **Enable** to enable memory-sparing support for memory ranks to improve memory performance. The options are **Disable** and **Enable**.

Correctable Error Threshold

Use this item to specify the threshold value for correctable memory-error logging, which sets a limit on the maximum number of events that can be logged in the memory-error log at a given time. The default setting is **10**.

SDDC

Single Device Data Correction (SDDC) organizes data in a single bundle (x4/x8 DRAM). If any or all the bits become corrupted, corrections occur. The x4 condition is corrected on all cases. The x8 condition is corrected only if the system is in Lockstep Mode. The options are **Disable** and **Enable**.

ADDDC Sparing

Adaptive Double Device Data Correction (ADDDC) Sparing detects when the predetermined threshold for correctable errors is reached, copying the contents of the failing DIMM to spare memory. The failing DIMM or memory rank will then be disabled. The options are **Disable** and **Enable**.

Patrol Scrub

Patrol Scrubbing is a process that allows the CPU to correct correctable memory errors detected on a memory module and send the correction to the requestor (the original source). When this item is set to **Enable**, the IO hub will read and write back one cache line every 16K cycles, if there is no delay caused by internal processing. By using this method, roughly 64 GB of memory behind the IO hub will be scrubbed every day. The options are **Disable** and **Enable**.

Patrol Scrub Interval

This feature allows you to decide how many hours the system should wait before the next complete patrol scrub is performed. Use the keyboard to enter a value from 0-24. The default setting is **24**.

► IIO Configuration

EV DFX Features

► CPU1 Configuration

IOU0 (IIO PCIe Br1)

This item configures the PCI-E port Bifurcation setting for a PCI-E port specified by the user. The options are x4x4x4x4, x4x4x8, x8x4x4, x8x8, x16, and **Auto**.

IOU1 (IIO PCIe Br2)

This item configures the PCI-E port Bifurcation setting for a PCI-E port specified by the user. The options are x4x4x4x4, x4x4x8, x8x4x4, x8x8, x16, and **Auto**.

IOU2 (IIO PCIe Br3)

This item configures the PCI-E port Bifurcation setting for a PCI-E port specified by the user. The options are x4x4x4x4, x4x4x8, x8x4x4, x8x8, x16, and **Auto**.

► **CPU SLOT6 PCI-E 3.0 X8 / CPU SLOT4 PCI-E X8 / CPU SLOT5 3.0 PCI-E X16/
CPU SLOT2 PCI-E 3.0 X8 / CPU SLOT1 PCI-E 3.0 X4**

Link Speed

Use this item to select the link speed for the PCI-E port specified by the user. The options are **Auto**, Gen 1 (2.5 GT/s), Gen 2 (5 GT/s), and Gen 3 (8 GT/s).

PCI-E Port Max Payload Size

Selecting **Auto** for this feature will enable the motherboard to automatically detect the maximum Transaction Layer Packet (TLP) size for the connected PCI-E device, allowing for maximum I/O efficiency. Selecting 128B or 256B will designate maximum packet size of 128 or 256. Options are **Auto**, 128, and 256. **Auto** is enabled by default.

► **CPU2 Configuration**

IOU2 (IIO PCIe Br3)

This item configures the PCI-E port Bifurcation setting for a PCI-E port specified by the user. The options are x4x4x4x4, x4x4x8, x8x4x4, x8x8, x16, and **Auto**.

► **CPU SLOT3 PCI-E 3.0 X16**

Link Speed

Use this item to select the link speed for the PCI-E port specified by the user. The options are **Auto**, Gen 1 (2.5 GT/s), Gen 2 (5 GT/s), and Gen 3 (8 GT/s).

PCI-E Port Max Payload Size

Selecting **Auto** for this feature will enable the motherboard to automatically detect the maximum Transaction Layer Packet (TLP) size for the connected PCI-E device, allowing for maximum I/O efficiency. Selecting 128B or 256B will designate maximum packet size of 128 or 256. Options are **Auto**, 128, and 256. **Auto** is enabled by default.

► **IOAT Configuration**

Disable TPH

Transparent Hugepages is a Linux memory management system that enables communication in larger blocks (pages). Enabling this feature will increase performance. The options are **No** and Yes.

Prioritize TPH

Use this feature to enable Prioritize TPH support. The options are Enable and **Disable**.

Relaxed Ordering

Select Enable to enable Relaxed Ordering support which will allow certain transactions to violate the strict-ordering rules of PCI bus for a transaction to be completed prior to other transactions that have already been enqueued. The options are **Disable** and **Enable**.

► Intel® VT for Directed I/O (VT-d)

Intel® VT for Directed I/O (VT-d)

Select Enable to use Intel Virtualization Technology for Direct I/O VT-d support by reporting the I/O device assignments to the VMM (Virtual Machine Monitor) through the DMAR ACPI tables. This feature offers fully-protected I/O resource sharing across Intel platforms, providing greater reliability, security and availability in networking and data-sharing. The options are **Disabled** and **Enabled**.

Interrupt Remapping

Select Enable for Interrupt Remapping support to enhance system performance. The options are **Enable** and **Disable**.

PassThrough DMA

Use this feature to allow devices such as network cards to access the system memory without using a processor. Select Enable to use the Non-Iscoch VT_D Engine Pass Through Direct Memory Access (DMA) support. The options are **Enable** and **Disable**.

ATS

Use this feature to enable Non-Iscoch VT-d Engine Address Translation Services (ATS) support. ATS translates virtual addresses to physical addresses. The options are **Enable** and **Disable**.

Posted Interrupt

Use this feature to enable VT_D Posted Interrupt. The options are **Enable** and **Disable**.

Coherency Support (Non-Iscoch)

Use this feature to maintain setting coherency between processors or other devices. Select Enable for the Non-Iscoch VT-d engine to pass through DMA to enhance system performance. The options are **Enable** and **Disable**.

▶ Intel® VMD Technology

▶ Intel® VMD for Volume Management Device on CPU1

VMD Config for PStack0

Intel® VMD for Volume Management Device

Select Enable to use the Intel Volume Management Device Technology for this stack. The options are **Disable** and Enable.

**If the item "Intel VMD for Volume Management Device" above is set to Enable, the following items will be displayed:*

CPU SLOT6 PCI-E 3.0 X8 VMD (Available when the device is detected by the system)

Select Enable to use the Intel Volume Management Device Technology for this specific root port. The options are **Disable** and Enable.

CPU SLOT4 PCI-E 3.0 X8 VMD (Available when the device is detected by the system)

Select Enable to use the Intel Volume Management Device Technology for this specific root port. The options are **Disable** and Enable.

Hot Plug Capable (Available when the device is detected by the system)

Use this feature to enable hot plug support for PCIe root ports 1A~1D. The options are **Disable** and Enable.

VMD Config for PStack1

Intel® VMD for Volume Management Device

Select Enable to use the Intel Volume Management Device Technology for this stack. The options are **Disable** and Enable.

**If the item "Intel VMD for Volume Management Device" above is set to Enable, the following items will be displayed:*

CPU SLOT5 PCI-E 3.0 X16 VMD (Available when the device is detected by the system)

Select Enable to use the Intel Volume Management Device Technology for this specific root port. The options are **Disable** and Enable.

Hot Plug Capable (Available when the device is detected by the system)

Use this feature to enable hot plug support for PCIe root ports 2A~2D. The options are **Disable** and **Enable**.

VMD Config for PStack2**Intel® VMD for Volume Management Device**

Select **Enable** to use the Intel Volume Management Device Technology for this stack. The options are **Disable** and **Enable**.

****If the item "Intel VMD for Volume Management Device" above is set to Enable, the following items will be displayed:***

CPU SLOT2 PCI-E 3.0 X8 VMD (Available when the device is detected by the system)

Select **Enable** to use the Intel Volume Management Device Technology for this specific root port. The options are **Disable** and **Enable**.

CPU SLOT1 PCI-E 3.0 X4 VMD (Available when the device is detected by the system)

Select **Enable** to use the Intel Volume Management Device Technology for this specific root port. The options are **Disable** and **Enable**.

Hot Plug Capable (Available when the device is detected by the system)

Use this feature to enable hot plug support for PCIe root ports 3A~3D. This will allow the user to replace the components without shutting down the system. The options are **Disable** and **Enable**.

► Intel® VMD for Volume Management Device on CPU2**VMD Config for PStack2****Intel® VMD for Volume Management Device**

Select **Enable** to use the Intel Volume Management Device Technology for this stack. The options are **Disable** and **Enable**.

****If the item "Intel VMD for Volume Management Device" above is set to Enable, the following items will be displayed:***

CPU SLOT3 PCI-E 3.0 X16 VMD (Available when the device is detected by the system)

Select **Enable** to use the Intel Volume Management Device Technology for this specific root port. The options are **Disable** and **Enable**.

Hot Plug Capable (Available when the device is detected by the system)

Use this feature to enable hot plug support for PCIe root ports 3A~3D. The options are **Disable** and Enable.

PCI-E Completion Timeout Disable

Use this feature to enable PCI-E Completion Timeout support for electric tuning. The options are Yes, **No**, and Per-Port.

► South Bridge**Legacy USB Support**

This feature enables support for USB 2.0 and older. The options are **Enabled** and Disabled. Default setting is **Enabled**.

XHCI Hand-off

When this feature is disabled, the motherboard will not support USB 3.0. Options are Enabled and **Disabled**. Default setting is **Disabled**.

Port 60/64 Emulation

Select Enabled for legacy I/O support for USB devices such as mice and keyboards. The options are **Enabled** and disabled. Default setting is **Enabled**.

► Server ME (Management Engine) Configuration

This feature displays the following system ME configuration settings.

- General ME Configuration
- Operational Firmware Version
- ME Firmware Type
- Recovery Firmware Version
- ME Firmware Features
- ME Firmware Status #1
- ME Firmware Status #2
- Current State
- Error Code

► PCH SATA Configuration

When this submenu is selected, the AMI BIOS automatically detects the presence of the SATA devices that are supported by the Intel PCH chip and displays the following items:

SATA Controller

This item enables or disables the onboard SATA controller supported by the Intel PCH chip. The options are Disable and **Enable**.

Configure SATA as

Select IDE to configure a SATA drive specified by the user as an IDE drive. Select AHCI to configure a SATA drive specified by the user as an AHCI drive. Select RAID to configure a SATA drive specified by the user as a RAID drive. The options are IDE, **AHCI**, and RAID.

SATA HDD Unlock

This feature allows the user to remove any password-protected SATA disk drives.

Aggressive Link Power Management

When this item is set to Enabled, the SATA AHCI controller manages the power usage of the SATA link. The controller will put the link in a low power mode during extended periods of I/O inactivity, and will return the link to an active state when I/O activity resumes. The options are Disabled and **Enabled**.

****If the item above "Configure SATA as" is set to RAID, the following items will display:***

SATA Port 0 ~ Port 7

This item displays the information detected on the installed SATA drive on the particular SATA port.

- Model number of drive and capacity
- Software Preserve Support

Port 0 ~ Port 7 Hot Plug

Set this item to Enabled for hot-plugging support, which will allow the user to replace a SATA drive without shutting down the system. The options are Disabled and **Enabled**.

Port 0 ~ Port 6 Spin Up Device

On an edge detect from 0 to 1, set this item to allow the PCH to initialize the device. The options are **Disabled** and Enabled.

Port 0 ~ Port 6 SATA Device Type

Use this item to specify if the SATA port specified by the user should be connected to a Solid State drive or a Hard Disk Drive. The options are **Hard Disk Drive** and Solid State Drive.

► PCH sSATA Configuration

When this submenu is selected, the AMI BIOS automatically detects the presence of the SATA devices that are supported by the Intel PCH chip and displays the following items:

sSATA Controller

This item enables or disables the onboard sSATA controller supported by the Intel PCH chip. The options are Disable and **Enable**.

Configure sSATA as

Select AHCI to configure an sSATA drive specified by the user as an AHCI drive. Select RAID to configure an sSATA drive specified by the user as a RAID drive. The options are **AHCI**, and RAID.

SATA HDD Unlock

This feature allows the user to remove any password-protected SATA disk drives.

Aggressive Link Power Management

When this item is set to Enabled, the SATA AHCI controller manages the power usage of the SATA link. The controller will put the link in a low power mode during extended periods of I/O inactivity, and will return the link to an active state when I/O activity resumes. The options are Disabled and **Enabled**.

****If the item above "Configure SATA as" is set to RAID, the following items will display:***

sSATA Port 0 ~ Port 2

This item displays the information detected on the installed sSATA drive on the particular sSATA port.

- Model number of drive and capacity
- Software Preserve Support

Port 0 ~ Port 2 Hot Plug

Set this item to Enabled for hot-plugging support, which will allow the user to replace a SATA drive without shutting down the system. The options are Disabled and **Enabled**.

Port 0 ~ Port 2 Spin Up Device

On an edge detect from 0 to 1, set this item to allow the PCH to initialize the device. The options are **Disabled** and Enabled.

Port 0 ~ Port 2 SsATA Device Type

Use this item to specify if the SATA port specified by the user should be connected to a Solid State drive or a Hard Disk Drive. The options are **Hard Disk Drive** and Solid State Drive.

► PCIe/PCI/PnP Configuration

The following information will display:

- PCI Bus Driver Version
- PCI Devices Common Settings:

Above 4G Decoding (Available if the system supports 64-bit PCI decoding)

Select Enabled to decode a PCI device that supports 64-bit in the space above 4G Address. The options are **Disabled** and Enabled.

SR-IOV Support

Use this feature to enable or disable Single Root IO Virtualization Support. The options are **Disabled** and Enabled.

MMIOHBase

Use this item to select the base memory size according to memory-address mapping for the IO hub. The options are **56 TB**, 40 TB, 24 TB, 3 TB, 2 TB, and 1 TB.

MMIO High Granularity Size

Use this item to select the high memory size according to memory-address mapping for the IO hub. The options are **256 GB**, 128 GB, 512 GB, and 1024 GB.

PCI PERR/SERR Support

Select Enabled to allow a PCI device to generate a PERR/SERR number for a PCI Bus Signal Error Event. The options are Enabled and **Disabled**.

Maximum Read Request

Select Auto for the system BIOS to automatically set the maximum size for a read request for a PCI-E device to enhance system performance. The options are **Auto**, 128 Bytes, 256 Bytes, 512 Bytes, 1024 Bytes, 2048 Bytes, and 4096 Bytes.

MMCFG Base

Use this item to select the low base address for PCIE adapters to increase base memory. The options are 1G, 1.5G, 1.75G, **2G**, 2.25G. and 3G.

NVMe Firmware Source

Use this item to select the NVMe firmware to support booting. The options are **Vendor Defined Firmware** and AMI Native Support. The default option, Vendor Defined Firmware, is pre-installed on the drive and may resolve errata or enable innovative functions for the drive. The other option, AMI Native Support, is offered by the BIOS with a generic method.

VGA Priority

Use this item to select the graphics device to be used as the primary video display for system boot. The options are **Onboard** and Offboard.

CPU SLOT1 PCI-E 3.0 X4 OPROM

Select Enabled to enable Option ROM support to boot the computer using a device installed on the slot specified by the user. The options are Disabled, Legacy and EFI. Use this feature to select which firmware type to be loaded for the add-on card in this slot. The options are Disabled, **Legacy**, and EFI.

CPU SLOT2 PCI-E 3.0 X8 OPROM

Use this feature to select which firmware type to be loaded for the add-on card in this slot. The options are Disabled, **Legacy**, and EFI.

CPU SLOT3 PCI-E 3.0 X16 OPROM

Use this feature to select which firmware type to be loaded for the add-on card in this slot. The options are Disabled, **Legacy**, and EFI.

CPU SLOT4 PCI-E 3.0 X8 OPROM

Use this feature to select which firmware type to be loaded for the add-on card in this slot. The options are Disabled, **Legacy**, and EFI.

CPU SLOT5 PCI-E 3.0 X16 OPROM

Use this feature to select which firmware type to be loaded for the add-on card in this slot. The options are Disabled, **Legacy**, and EFI.

CPU SLOT6 PCI-E 3.0 X8 OPROM

Use this feature to select which firmware type to be loaded for the add-on card in this slot. The options are Disabled, **Legacy**, and EFI.

M.2 PCI-E 3.0 X4 OPROM

Use this feature to select which firmware type to be loaded for the add-on card in this slot. The options are Disabled, **Legacy**, and EFI.

Onboard LAN Device

Select Enabled to enable the Onboard LAN device. The options are **Enabled** and Disabled.

Onboard LAN1 Option ROM

Use this feature to select which firmware function to be loaded for LAN Port1 used for system boot. The options are Disabled, **Legacy**, and EFI.

Onboard LAN2 Option ROM

Use this feature to select which firmware function to be loaded for LAN Port2 used for system boot. The options are **Disabled**, Legacy, and EFI.

Onboard NVMe1 Option ROM

Use this feature to select which firmware function to be loaded for NVMe1 used for system boot. The options are Disabled, Legacy, and **EFI**.

Onboard NVMe2 Option ROM

Use this feature to select which firmware function to be loaded for NVMe2 used for system boot. The options are Disabled, Legacy, and **EFI**.

Onboard Video Option ROM

Use this item to select the Onboard Video Option ROM type. The options are Disabled, **Legacy**, and EFI.

► Network Stack Configuration

Network Stack

Select Enabled to enable PXE (Preboot Execution Environment) or UEFI (Unified Extensible Firmware Interface) for network stack support. The options are **Enabled** and Disabled.

IPv4 PXE Support

Select Enabled to enable IPv4 PXE boot support. The options are Disabled and **Enabled**.

IPv4 HTTP Support

Select Enabled to enable IPv4 HTTP boot support. The options are **Disabled** and Enabled.

IPv6 PXE Support

Select Enabled to enable IPv6 PXE boot support. The options are Disabled and **Enabled**.

IPv6 HTTP Support

Select Enabled to enable IPv6 HTTP boot support. The options are **Disabled** and Enabled.

PXE Boot Wait Time

Use this option to specify the wait time to press the ESC key to abort the PXE boot. Press "+" or "-" on your keyboard to change the value. The default setting is **0**.

Media Detect Count

Use this option to specify the number of times media will be checked. Press "+" or "-" on your keyboard to change the value. The default setting is **1**.

► Super IO Configuration

The following Super IO information will display:

- Super IO Chip AST2500

► Serial Port 1 Configuration

This submenu allows the user the configure settings of Serial Port 1.

Serial Port 1

Select Enabled to enable the selected onboard serial port. The options are Disabled and **Enabled**.

Device Settings

This item displays the status of a serial part specified by the user.

Serial Port 1 Change Settings

This feature specifies the base I/O port address and the Interrupt Request address of a serial port specified by the user. Select Auto to allow the BIOS to automatically assign the base I/O and IRQ address.

The options for Serial Port 1 are **Auto**, (IO=3F8h; IRQ=4;), (IO=3F8h; IRQ=3, 4, 5, 6, 7, 9, 10, 11, 12;), (IO=2F8h; IRQ=3, 4, 5, 6, 7, 9, 10, 11, 12;), (IO=3E8h; IRQ=3, 4, 5, 6, 7, 9, 10, 11, 12;), and (IO=2E8h; IRQ=3, 4, 5, 6, 7, 9, 10, 11, 12;).

► SOL Configuration

This submenu allows the user to configure the settings of Serial Port 2.

SOL

Select Enabled to enable the selected onboard serial port. The options are Disabled and **Enabled**.

Device Settings

This item displays the status of a serial port specified by the user.

Change Settings

This feature specifies the base I/O port address and the Interrupt Request address of a serial port specified by the user. Select Auto to allow the BIOS to automatically assign the base I/O and IRQ address.

The options for Serial Port 2 are **Auto**, (IO=2F8h; IRQ=3;), (IO=3F8h; IRQ=3, 4, 5, 6, 7, 9, 10, 11, 12;), (IO=2F8h; IRQ=3, 4, 5, 6, 7, 9, 10, 11, 12;), (IO=3E8h; IRQ=3, 4, 5, 6, 7, 9, 10, 11, 12;), and (IO=2E8h; IRQ=3, 4, 5, 6, 7, 9, 10, 11, 12;).

SOL Attribute

Select SOL to use COM Port 2 as a Serial Over LAN (SOL) port for console . The options are **SOL** and **COM**.

► Serial Port Console Redirection

COM0 Console Redirection

Select Enabled to enable console redirection support for a serial port specified by the user. The options are Enabled and **Disabled**.

**If the item above set to Enabled, the following items will become available for user's configuration:*

► COM1 Console Redirection Settings

This feature allows the user to specify how the host computer will exchange data with the client computer, which is the remote computer used by the user.

Terminal Type

This feature allows the user to select the target terminal emulation type for Console Redirection. Select VT100 to use the ASCII Character set. Select VT100+ to add color and function key support. Select ANSI to use the Extended ASCII Character Set. Select VT-UTF8 to use UTF8 encoding to map Unicode characters into one or more bytes. The options are VT100, **VT100+**, VT-UTF8, and ANSI.

Bits per second

Use this feature to set the transmission speed for a serial port used in Console Redirection. Make sure that the same speed is used in the host computer and the client computer. A lower transmission speed may be required for long and busy lines. The options are 9600, 19200, 38400, 57600 and **115200** (bits per second).

Data Bits

Use this feature to set the data transmission size for Console Redirection. The options are 7 Bits and **8 Bits**.

Parity

A parity bit can be sent along with regular data bits to detect data transmission errors. Select Even if the parity bit is set to 0, and the number of 1's in data bits is even. Select Odd if the parity bit is set to 0, and the number of 1's in data bits is odd. Select None if you do not want to send a parity bit with your data bits in transmission. Select Mark to add a mark as a parity bit to be sent along with the data bits. Select Space to add a Space as a parity bit to be sent with your data bits. The options are **None**, Even, Odd, Mark, and Space.

Stop Bits

A stop bit indicates the end of a serial data packet. Select 1 Stop Bit for standard serial data communication. Select 2 Stop Bits if slower devices are used. The options are **1** and 2.

Flow Control

Use this feature to set the flow control for Console Redirection to prevent data loss caused by buffer overflow. Send a "Stop" signal to stop sending data when the receiving buffer is full. Send a "Start" signal to start sending data when the receiving buffer is empty. The options are **None** and Hardware RTS/CTS.

VT-UTF8 Combo Key Support

Select Enabled to enable VT-UTF8 Combination Key support for ANSI/VT100 terminals. The options are Disabled and **Enabled**.

Recorder Mode

Select Enabled to capture the data displayed on a terminal and send it as text messages to a remote server. The options are **Disabled** and Enabled.

Resolution 100x31

Select Enabled for extended-terminal resolution support. The options are Disabled and **Enabled**.

Legacy OS Redirection Resolution

Use this feature to select the number of rows and columns used in Console Redirection for legacy OS support. The options are 80x24 and **80x25**.

Putty KeyPad

This feature selects the settings for Function Keys and KeyPad used for Putty, which is a terminal emulator designed for the Windows OS. The options are **VT100**, LINUX, XTERMR6, SC0, ESCN, and VT400.

Redirection After BIOS POST

Use this feature to enable or disable legacy console redirection after BIOS POST. When set to Bootloader, legacy console redirection is disabled before booting the OS. When set to Always Enable, legacy console redirection remains enabled when booting the OS. The options are **Always Enable** and Bootloader.

SOL Console Redirection

Select Enabled to use the SOL port for Console Redirection. The options are Disabled and **Enabled**.

****If the item above is set to Enabled, the following items will become available for configuration:***

► SOL Console Redirection Settings

Use this feature to specify how the host computer will exchange data with the client computer, which is the remote computer used by the user.

Terminal Type

Use this feature to select the target terminal emulation type for Console Redirection. Select VT100 to use the ASCII Character set. Select VT100+ to add color and function key support. Select ANSI to use the Extended ASCII Character Set. Select VT-UTF8 to use UTF8 encoding to map Unicode characters into one or more bytes. The options are ANSI, VT100, **VT100+**, and VT-UTF8.

Bits Per Second

Use this feature to set the transmission speed for a serial port used in Console Redirection. Make sure that the same speed is used in the host computer and the client computer. A lower transmission speed may be required for long and busy lines. The options are 9600, 19200, 38400, 57600 and **115200** (bits per second).

Data Bits

Use this feature to set the data transmission size for Console Redirection. The options are 7 Bits and **8 Bits**.

Parity

A parity bit can be sent along with regular data bits to detect data transmission errors. Select Even if the parity bit is set to 0, and the number of 1's in data bits is even. Select Odd if the parity bit is set to 0, and the number of 1's in data bits is odd. Select None if you do not want to send a parity bit with your data bits in transmission. Select Mark to add a mark as a parity bit to be sent along with the data bits. Select Space to add a Space as a parity bit to be sent with your data bits. The options are **None**, Even, Odd, Mark and Space.

Stop Bits

A stop bit indicates the end of a serial data packet. Select 1 Stop Bit for standard serial data communication. Select 2 Stop Bits if slower devices are used. The options are **1** and **2**.

Flow Control

Use this feature to set the flow control for Console Redirection to prevent data loss caused by buffer overflow. Send a "Stop" signal to stop sending data when the receiving buffer is full. Send a "Start" signal to start sending data when the receiving buffer is empty. The options are **None** and Hardware RTS/CTS.

VT-UTF8 Combo Key Support

Select Enabled to enable VT-UTF8 Combination Key support for ANSI/VT100 terminals. The options are Disabled and **Enabled**.

Recorder Mode

Select Enabled to capture the data displayed on a terminal and send it as text messages to a remote server. The options are **Disabled** and Enabled.

Resolution 100x31

Select Enabled for extended-terminal resolution support. The options are Disabled and **Enabled**.

Legacy OS Redirection Resolution

Use this feature to select the number of rows and columns used in Console Redirection for legacy OS support. The options are **80x24** and 80x25.

Putty KeyPad

This feature selects Function Keys and KeyPad settings for Putty, which is a terminal emulator designed for the Windows OS. The options are **VT100**, LINUX, XTERMR6, SCO, ESCN, and VT400.

Redirection After BIOS POST

Use this feature to enable or disable legacy Console Redirection after BIOS POST. When set to Bootloader, legacy Console Redirection is disabled before booting the OS. When set to Always Enable, legacy Console Redirection remains enabled when booting the OS. The options are **Always Enable** and Bootloader.

Legacy Console Redirection

Legacy Serial Redirection Port

Use this feature to select a COM port to display redirection of Legacy OS and Legacy OPROM messages. The options are **COM1** and SOL/COM2.

EMS (Emergency Management Services) Console Redirection

Select Enabled to use a COM port selected by the user for EMS Console Redirection. The options are Enabled and **Disabled**.

****If the item above is set to Enabled, the following items will become available for configuration:***

► EMS Console Redirection Settings

This feature allows the user to specify how the host computer will exchange data with the client computer, which is the remote computer used by the user.

Out-of-Band Mgmt Port

The feature selects a serial port in a client server to be used by the Microsoft Windows Emergency Management Services (EMS) to communicate with a remote host server. The options are COM1 and SOL/COM2.

Terminal Type

Use this feature to select the target terminal emulation type for Console Redirection. Select VT100 to use the ASCII character set. Select VT100+ to add color and function key support. Select ANSI to use the extended ASCII character set. Select VT-UTF8 to use UTF8 encoding to map Unicode characters into one or more bytes. The options are VT100, VT100+, **VT-UTF8**, and ANSI.

Bits Per Second

This item sets the transmission speed for a serial port used in Console Redirection. Make sure that the same speed is used in the host computer and the client computer. A lower transmission speed may be required for long and busy lines. The options are 9600, 19200, 57600, and **115200** (bits per second).

Flow Control

Use this item to set the flow control for Console Redirection to prevent data loss caused by buffer overflow. Send a "Stop" signal to stop sending data when the receiving buffer is full. Send a "Start" signal to start sending data when the receiving buffer is empty. The options are **None**, Hardware RTS/CTS, and Software Xon/Xoff.

Data Bits, Parity, Stop Bits

►ACPI Settings

Numa

This setting **Enables** or Disables Non-Uniform Memory Access (NUMA), a feature that improves memory-to-processor communication and performance. The options are **Enabled** or Disabled.

WHEA Support

Select Enabled to support the Windows Hardware Error Architecture (WHEA) platform and provide a common infrastructure for the system to handle hardware errors within the Windows OS environment to reduce system crashes and to enhance system recovery and health monitoring. The options are Enabled and **Disabled**.

High Precision Timer

Select Enabled to activate the High Precision Event Timer (HPET) that produces periodic interrupts at a much higher frequency than a Real-time Clock (RTC) does in synchronizing multimedia streams, providing smooth playback and reducing the dependency on other timestamp calculation devices, such as an x86 RDTSC Instruction embedded in the CPU. The High Performance Event Timer is used to replace the 8254 Programmable Interval Timer. The options are **Enabled** and Disabled.

►Trusted Computing Configuration (Available when a TPM device is installed and detected by the BIOS)

When a TPM (Trusted-Platform Module) device is detected in your machine, the following information will be displayed.

- TPM2.0 Device Found
- Vendor
- Firmware Version

Security Device Support

If this feature and the TPM jumper (JPT1) on the motherboard are both enabled, the onboard security (TPM) device will be enabled in the BIOS to enhance data integrity and system security. Please note that the OS will not show the security device. Neither TCG EFI protocol nor INT1A interaction will be made available for use. If you have made changes on the setting on this item, be sure to reboot the system for the change to take effect. The options are Disable and **Enable**. If this option is set to Enable, the following screen and items will display:



- Active PCR Banks
- Available PCR Banks

Pending Operation

Use this feature to schedule a TPM-related operation to be performed by a security (TPM) device at the next system boot to enhance system data integrity. Your system will reboot to carry out a pending TPM operation. The options are **None** and TPM Clear.

Note: Your system will reboot to carry out a pending TPM operation.

Platform Hierarchy (for TPM Version 2.0 and above)

Select Enabled for TPM Platform Hierarchy support which will allow the manufacturer to utilize the cryptographic algorithm to define a constant key or a fixed set of keys to be used for initial system boot. This early boot code is shipped with the platform and is included in the list of "public keys". During system boot, the platform firmware uses this trusted public key to verify a digital signature in an attempt to manage and control the security of the platform firmware used in a host system via a TPM device. The options are **Enabled** and Disabled.

Storage Hierarchy

Select Enabled for TPM Storage Hierarchy support that is intended to be used for non-privacy-sensitive operations by the platform owner such as an IT professional or the end user. Storage Hierarchy has an owner policy and an authorization value, both of which can be set and are held constant (-rarely changed) through reboots. This hierarchy can be cleared or changed independently of the other hierarchies. The options are **Enabled** and Disabled.

Endorsement Hierarchy

Select Enabled for Endorsement Hierarchy support, which contains separate controls to address the user's privacy concerns because the primary keys in this hierarchy are certified by the TPM or a manufacturer to be constrained to an authentic TPM device that is attached to an authentic platform. A primary key can be an encrypted, and a certificate can be created using TPM2_ActivateCredential. It allows the user to independently enable "flag, policy, and authorization value" without involving other hierarchies. A user with privacy concerns can disable the endorsement hierarchy while still using the storage hierarchy for TPM applications and permitting the platform software to use the TPM. The options are **Enabled** and Disabled.

PH (Platform Hierarchy) Randomization (for TPM Version 2.0 and above)

Select Enabled for Platform Hierarchy Randomization support, which is used only during the platform developmental stage. This feature cannot be enabled in the production platforms. The options are **Disabled** and Enabled.

TXT Support

Select Enabled to enable Intel Trusted Execution Technology (TXT) support to enhance system security and data integrity. The options are **Disabled** and Enabled.

Note 1: If the option for this item (TXT Support) is set to Enabled, be sure to disable EV DFX (Device Function On-Hide) support for the system to work properly. (EV DFX is under "IIO Configuration" in the "Chipset/North Bridge" submenu).

Note 2: For more information on TPM, please refer to the TPM manual at <http://www.supermicro.com/manuals/other>.

► iSCSI Configuration

iSCSI Initiator Name

This feature allows the user to enter the unique name of the iSCSI Initiator in IQN format. Once the name of the iSCSI Initiator is entered into the system, configure the proper settings for the following items.

► Add an Attempt

► Delete Attempts

► Change Attempt Order

► Intel(R) Virtual RAID on CPU

Intel(R) VROC with VMD Technology 5.0.0.1205

RAID volumes and Intel VMD Controllers information will be displayed if they are detected by the system.

4.4 Event Logs

Use this feature to configure Event Log settings.

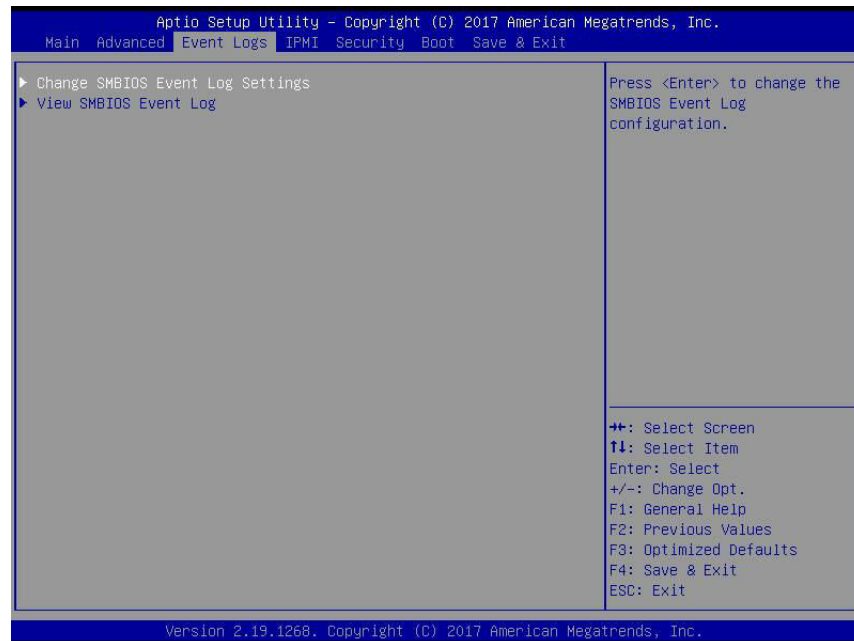

► Change SMBIOS Event Log Settings

Enabling/Disabling Options

SMBIOS Event Log

Change this item to enable or disable all features of the SMBIOS Event Logging during system boot. The options are **Enabled** and Disabled.

Erasing Settings

Erase Event Log

If No is selected, data stored in the event log will not be erased. Select Yes, Next Reset, data in the event log will be erased upon next system reboot. Select Yes, Every Reset, data in the event log will be erased upon every system reboot. The options are **No**, Yes, Next reset, and Yes, Every reset.

When Log is Full

Select Erase Immediately for all messages to be automatically erased from the event log when the event log memory is full. The options are **Do Nothing** and Erase Immediately.

SMBIOS Event Long Standard Settings

Log System Boot Event

This option toggles the System Boot Event logging to enabled or disabled. The options are **Disabled** and **Enabled**.

MECI

The Multiple Event Count Increment (MECI) counter counts the number of occurrences that a duplicate event must happen before the MECI counter is incremented. This is a numeric value. The default value is **1**.

METW

The Multiple Event Time Window (METW) defines number of minutes must pass between duplicate log events before MECI is incremented. This is in minutes, from 0 to 99. The default value is **60**.

Note: After making changes on a setting, be sure to reboot the system for the changes to take effect.

►View SMBIOS Event Log

This section displays the contents of the SMBIOS Event Log.

4.5 IPMI

Use this feature to configure Intelligent Platform Management Interface (IPMI) settings.

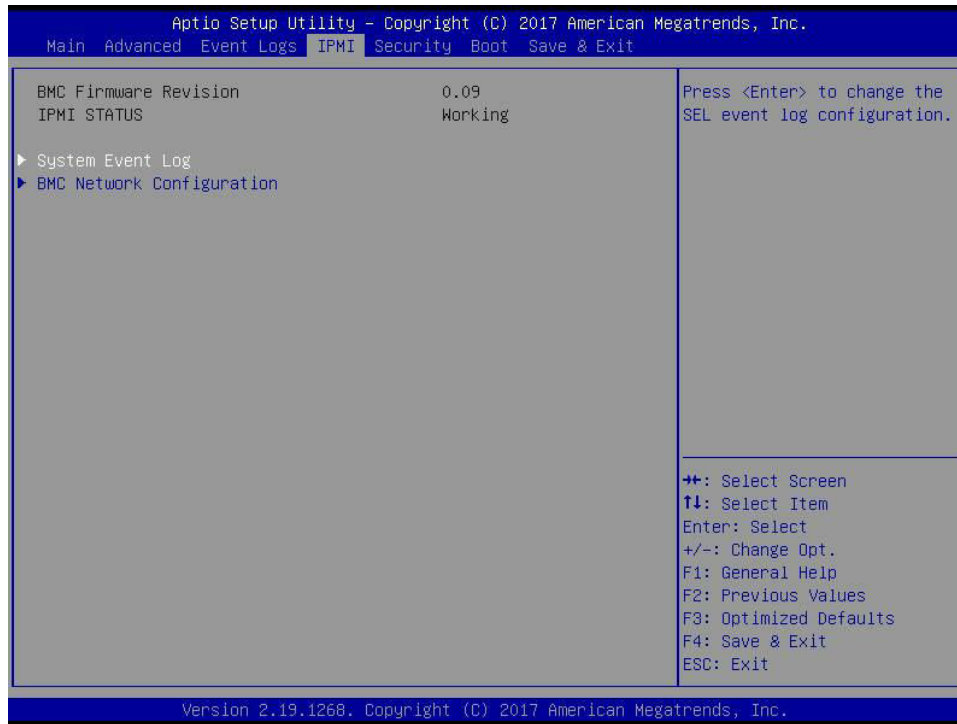

BMC Firmware Revision

This item indicates the IPMI firmware revision used in your system.

IPMI Status (Baseboard Management Controller)

This item indicates the status of the IPMI firmware installed in your system.

▶ System Event Log

Enabling/Disabling Options

SEL Components

Select Enabled for all system event logging at bootup. The options are **Enabled** and Disabled.

Erasing Settings

Erase SEL

Select Yes, On next reset to erase all system event logs upon next system reboot. Select Yes, On every reset to erase all system event logs upon each system reboot. Select No to keep all system event logs after each system reboot. The options are **No**, Yes, On next reset, and Yes, On every reset.

When SEL is Full

This feature allows the user to decide what the BIOS should do when the system event log is full. Select Erase Immediately to erase all events in the log when the system event log is full. The options are **Do Nothing** and Erase Immediately.

Note: After making changes on a setting, be sure to reboot the system for the changes to take effect.

►BMC Network Configuration

BMC Network Configuration

Configure IPV4 support

IPMI LAN Selection

This item displays the IPMI LAN setting. The default setting is **Failover**.

IPMI Network Link Status

This item displays the IPMI Network Link status. The default setting is **Dedicated LAN**.

Update IPMI LAN Configuration

Select Yes for the BIOS to implement all IP/MAC address changes at the next system boot. The options are No and Yes.

****If the item above set to Yes, the following item will become available for user's configuration:***

Configuration Address Source

This feature allows the user to select the source of the IP address for this computer. If Static is selected, you will need to know the IP address of this computer and enter it to the system manually in the field. If DHCP is selected, the BIOS will search for a DHCP (Dynamic Host Configuration Protocol) server in the network that is attached to and request the next available IP address for this computer. The options are **DHCP** and Static.

Station IP Address

This item displays the Station IP address for this computer. This should be in decimal and in dotted quad form (i.e., 192.168.10.253).

Subnet Mask

This item displays the sub-network that this computer belongs to. The value of each three-digit number separated by dots should not exceed 255.

Station MAC Address

This item displays the Station MAC address for this computer. Mac addresses are 6 two-digit hexadecimal numbers.

Gateway IP Address

This item displays the Gateway IP address for this computer. This should be in decimal and in dotted quad form (i.e., 172.31.0.1).

VLAN

This item displays the virtual LAN settings.

Configure IPV6 Support

This section displays configuration features for IPV6 support.

LAN Channel 1**IPV6 Support**

Use this feature to enable IPV6 support. The options are **Enabled** and Disabled.

Configuration Address Source

This feature allows the user to select the source of the IP address for this computer. If Static is selected, you will need to know the IP address of this computer and enter it to the system manually in the field. If DHCP is selected, the BIOS will search for a DHCP (Dynamic Host Configuration Protocol) server in the network that is attached to and request the next available IP address for this computer. The options are **Unspecified**, Static, and DHCP.

****If the item "Configuration Address Source" above is set to Static, the following items will become available for configuration:***

- Station IPV6 Address
- Prefix Length
- IPV6 Router1 IP Address

4.6 Security

This menu allows the user to configure the following security settings for the system.

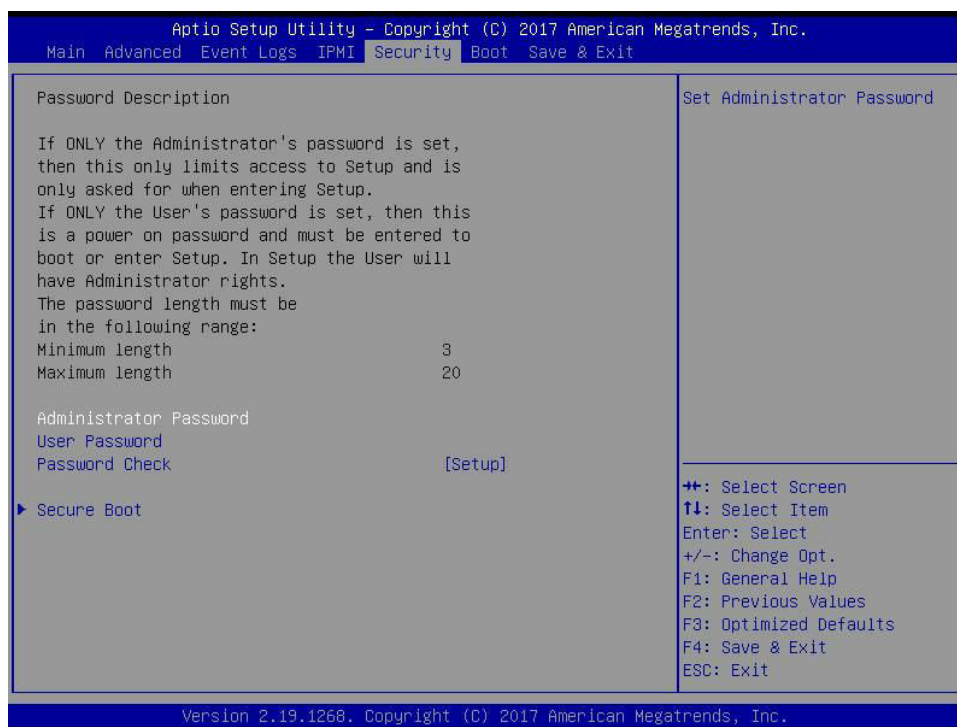

Administrator Password

Press Enter to create a new, or change an existing, Administrator password.

User Password

Press Enter to create a new, or change an existing, User password.

Password Check

Select Setup for the system to check for a password at Setup. Select Always for the system to check for a password at bootup or upon entering the BIOS Setup utility. The options are **Setup** and **Always**.

► Secure Boot Menu

This section displays the contents of the following secure boot features:

- System Mode
- Secure Boot
- Vendor Keys

Secure Boot

Use this item to enable secure boot. The options are **Disabled** and Enabled.

Secure Boot Mode

Use this item to configure Secure Boot variables without authentication. The options are Standard and **Custom**.

CSM Support

Select Enabled to support the EFI Compatibility Support Module (CSM), which provides compatibility support for traditional legacy BIOS for system boot. The options are **Enabled** and Disabled.

▶ Key Management

This submenu allows the user to configure the following Key Management settings.

Provision Factory Default Keys

Select Enabled to install the default Secure-Boot keys set by the manufacturer. The options are **Disabled** and Enabled.

▶ Enroll All Factory Default Keys

Select Yes to install all default secure keys set by the manufacturer. The options are **Yes** and No.

Save All Secure Boot Variables

This feature allows the user to decide if all secure boot variables should be saved.

▶ Platform Key (PK)

This feature allows the user to configure the settings of the platform keys.

Set New Key

Select Yes to load the new platform keys (PK) from the manufacturer's defaults. Select No to load the platform keys from a file. The options are **Yes** and No.

▶ Key Exchange Key**Set New Key**

Select Yes to load the KEK from the manufacturer's defaults. Select No to load the KEK from a file. The options are Yes and No.

Append Key

Select Yes to add the KEK from the manufacturer's defaults list to the existing KEK. Select No to load the KEK from a file. The options are Yes and No.

▶ Authorized Signatures

Set New Key

Select Yes to load the database from the manufacturer's defaults. Select No to load the DB from a file. The options are Yes and No.

Append Key

Select Yes to add the database from the manufacturer's defaults to the existing DB. Select No to load the DB from a file. The options are Yes and No.

▶ Forbidden Signatures

Set New Key

Select Yes to load the DBX from the manufacturer's defaults. Select No to load the DBX from a file. The options are Yes and No.

Append Key

Select Yes to add the DBX from the manufacturer's defaults to the existing DBX. Select No to load the DBX from a file. The options are Yes and No.

▶ Authorized TimeStamps

Set New Key

Select Yes to load the DBT from the manufacturer's defaults. Select No to load the DBT from a file. The options are Yes and No.

Append Key

Select Yes to add the DBT from the manufacturer's defaults list to the existing DBT. Select No to load the DBT from a file. The options are Yes and No.

▶ OsRecovery Signature

This item uploads and installs an OSRecovery Signature. You may insert a factory default key or load from a file. The file formats accepted are:

- 1) Public Key Certificate
 - a. EFI Signature List
 - b. EFI CERT X509 (DER Encoded)
 - c. EFI CERT RSA2048 (bin)
 - d. EFI SERT SHA256 (bin)
- 2) EFI Time Based Authenticated Variable

When prompted, select "Yes" to load Factory Defaults or "No" to load from a file.

Delete OSRecovery Signatures

This item deletes a previously installed OS Recovery Signature.

Append OsRecovery Signature

This item uploads and adds an OSRecovery Signature into the Key Management. You may insert a factory default key or load from a file. When prompted, select "Yes" to load Factory Defaults or "No" to load from a file.

4.7 Boot

Use this feature to configure Boot Settings:

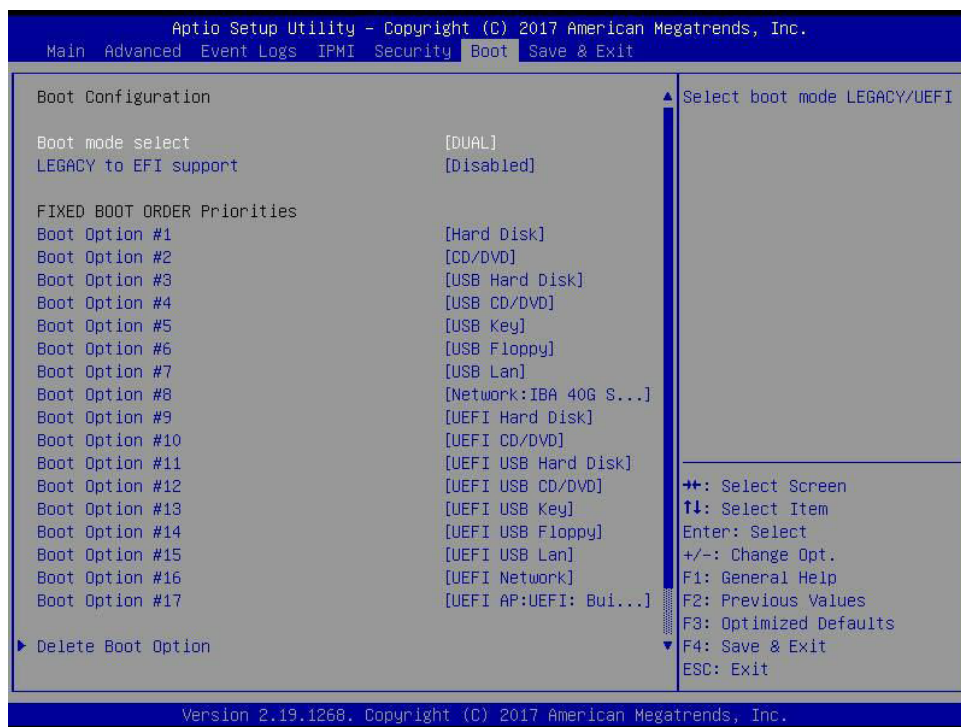

Boot Mode Select

Use this item to select the type of device that the system is going to boot from. The options are Legacy, UEFI, and **Dual**. The default setting is Dual.

Legacy to EFI Support

This feature **Enables** the system to boot to EFI OS if boot fails from Legacy boot order. The options are **Enabled** or Disabled.

Fixed Boot Order Priorities

This option prioritizes the order of bootable devices that the system to boot from. Press <Enter> on each entry from top to bottom to select devices.

****If the item above set to Legacy, UEFI/Dual the following items will be displayed:***

- Legacy/UEFI/Dual/Boot Order #1
- Legacy/UEFI/Dual/Boot Order #2
- Legacy/UEFI/Dual/Boot Order #3
- Legacy/UEFI/Dual/Boot Order #4
- Legacy/UEFI/Dual/Boot Order #5
- Legacy/UEFI/Dual/Boot Order #6
- Legacy/UEFI/Dual/Boot Order #7
- Legacy/UEFI/Dual/Boot Order #8
- UEFI/Dual/Boot Order #9
- Dual/Boot Order #10
- Dual/Boot Order #11
- Dual/Boot Order #12
- Dual/Boot Order #13
- Dual/Boot Order #14
- Dual/Boot Order #15
- Dual/Boot Order #16
- Dual/Boot Order #17

► Delete Boot Option

Use this feature to remove a pre-defined boot device from which the system will boot during startup.

The settings are [any pre-defined boot device].

► UEFI Application Boot Priorities

This feature allows the user to specify which UEFI devices are boot devices.

- UEFI Boot Order #1
- UEFI Boot Order #2

► NETWORK Drive BBS Priorities

This feature allows the user to specify which UEFI network drive devices are boot devices.

UEFI Boot Order #

4.8 Save & Exit

Select the Exit tab from the BIOS setup utility screen to enter the Exit BIOS Setup screen.

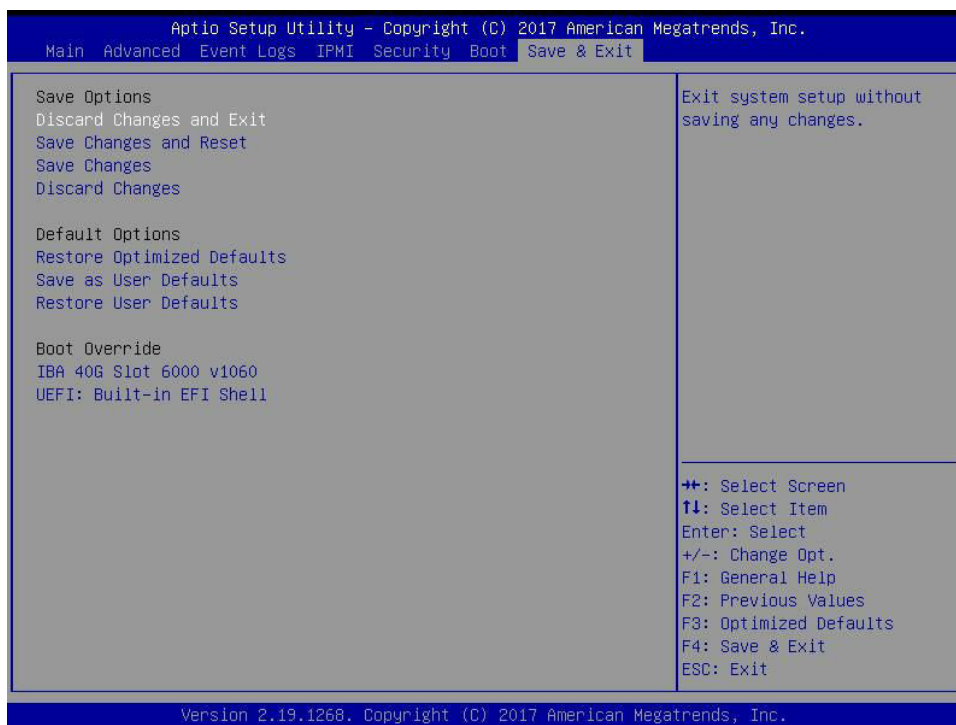

Save Options

Discard Changes and Exit

Select this option to quit the BIOS Setup without making any permanent changes to the system configuration, and reboot the computer. Select Discard Changes and Exit from the Save & Exit menu and press <Enter>.

Save Changes and Reset

After completing the system configuration changes, select this option to save the changes you have made. This will not reset (reboot) the system.

Save Changes

When you have completed the system configuration changes, select this option to leave the BIOS setup utility and reboot the computer for the new system configuration parameters to take effect. Select Save Changes from the Save & Exit menu and press <Enter>.

Discard Changes

Select this option and press <Enter> to discard all the changes and return to the AMI BIOS utility program.

Default Options

Restore Optimized Defaults

To set this feature, select Restore Defaults from the Save & Exit menu and press <Enter>. These are factory settings designed for maximum system stability, but not for maximum performance.

Save As User Defaults

To set this feature, select Save as User Defaults from the Save & Exit menu and press <Enter>. This enables the user to save any changes to the BIOS setup for future use.

Restore User Defaults

To set this feature, select Restore User Defaults from the Save & Exit menu and press <Enter>. Use this feature to retrieve user-defined settings that were saved previously.

Boot Override

Listed in this section are other boot options for the system (i.e., Built-in EFI shell). Select an option and press <Enter>. Your system will boot to the selected boot option.

Appendix A

BIOS Codes

A.1 BIOS Error POST (Beep) Codes

During the POST (Power-On Self-Test) routines, which are performed each time the system is powered on, errors may occur.

Non-fatal errors are those which, in most cases, allow the system to continue the boot-up process. The error messages normally appear on the screen.

Fatal errors are those which will not allow the system to continue the boot-up procedure. If a fatal error occurs, you should consult with your system manufacturer for possible repairs.

These fatal errors are usually communicated through a series of audible beeps. The numbers on the fatal error list (on the following page) correspond to the number of beeps for the corresponding error. All errors listed, with the exception of Beep Code 8, are fatal errors.

BIOS Beep (POST) Codes		
Beep Code	Error Message	Description
1 beep	Refresh	Circuits have been reset (Ready to power up)
5 short, 1 long	Memory error	No memory detected in system
5 long, 2 short	Display memory read/write error	Video adapter missing or with faulty memory
1 long continuous	System OH	System overheat condition

A.2 Additional BIOS POST Codes

The AMI BIOS supplies additional checkpoint codes, which are documented online at <http://www.supernmicro.com/support/manuals/> ("AMI BIOS POST Codes User's Guide").

When BIOS performs the Power On Self Test, it writes checkpoint codes to I/O port 0080h. If the computer cannot complete the boot process, a diagnostic card can be attached to the computer to read I/O port 0080h (Supernmicro p/n AOC-LPC80-20).

For information on AMI updates, please refer to <http://www.ami.com/products/>.

Appendix B

Software Installation

B.1 Installing Software Programs

The Supermicro FTP site contains drivers and utilities for your system at <ftp://ftp.supermicro.com>. Some of these must be installed, such as the chipset driver.

After accessing the FTP site, go into the CDR_Images directory and locate the ISO file for your motherboard. Download this file to create a CD/DVD of the drivers and utilities it contains. (You may also use a utility to extract the ISO file if preferred.)

After creating a CD/DVD with the ISO files, insert the disk into the CD/DVD drive on your system and the display shown in Figure B-1 should appear.

Another option is to go to the Supermicro website at <http://www.supermicro.com/products/>. Find the product page for your motherboard here, where you may download individual drivers and utilities to your hard drive or a USB flash drive and install from there.

 **Note:** To install the Windows OS, please refer to the instructions posted on our website at <http://www.supermicro.com/support/manuals/>.

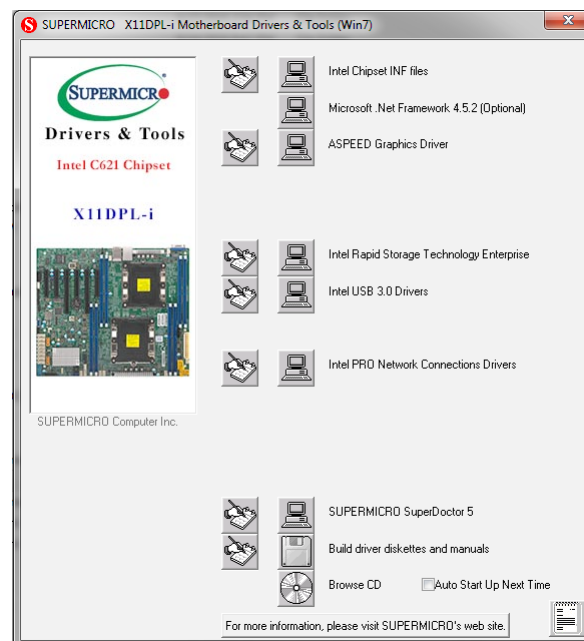

Figure B-1. Driver/Tool Installation Display Screen

Click the icons showing a hand writing on the paper to view the readme files for each item. Click a computer icon to the right of an item to install an item (from top to the bottom) one at a time. After installing each item, you must reboot the system before proceeding with the next item on the list. The bottom icon with a CD on it allows you to view the entire contents of the CD.

When making a storage driver diskette by booting into a driver CD, please set the SATA Configuration to "Compatible Mode" and configure SATA as IDE in the BIOS Setup. After making the driver diskette, be sure to change the SATA settings back to your original settings.

B.2 SuperDoctor® 5

The Supermicro SuperDoctor 5 is a hardware monitoring program that functions in a command-line or web-based interface in Windows and Linux operating systems. The program monitors system health information such as CPU temperature, system voltages, system power consumption, fan speed, and provides alerts via email or Simple Network Management Protocol (SNMP).

SuperDoctor 5 comes in local and remote management versions and can be used with Nagios to maximize your system monitoring needs. With SuperDoctor 5 Management Server (SSM Server), you can remotely control power on/off and reset chassis intrusion for multiple systems with SuperDoctor 5 or IPMI. SD5 Management Server monitors HTTP, FTP, and SMTP services to optimize the efficiency of your operation.



Note: The default Username and Password for SuperDoctor 5 is admin / admin.

Figure B-2. SuperDoctor 5 Interface Display Screen (Health Information)

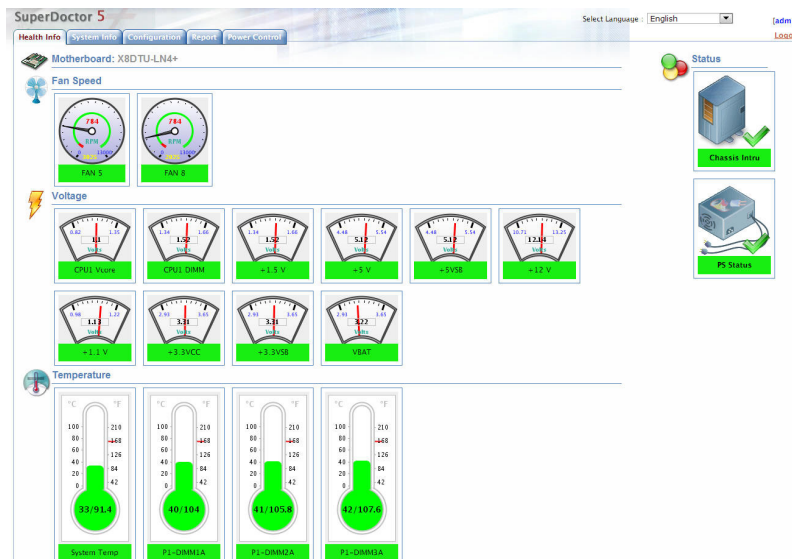

Note: The SuperDoctor 5 program and user's manual can be downloaded from the Supermicro website at http://www.supermicro.com/products/info/sms_sd5.cfm.

Appendix C

Standardized Warning Statements

The following statements are industry standard warnings, provided to warn the user of situations which have the potential for bodily injury. Should you have questions or experience difficulty, contact Supermicro's Technical Support department for assistance. Only certified technicians should attempt to install or configure components.

Read this section in its entirety before installing or configuring components.

These warnings may also be found on our website at http://www.supermicro.com/about/policies/safety_information.cfm.

Battery Handling



Warning! There is the danger of explosion if the battery is replaced incorrectly. Replace the battery only with the same or equivalent type recommended by the manufacturer. Dispose of used batteries according to the manufacturer's instructions

電池の取り扱い

電池交換が正しく行われなかった場合、破裂の危険性があります。交換する電池はメーカーが推奨する型、または同等のものを使用下さい。使用済電池は製造元の指示に従って処分して下さい。

警告

電池更換不當會有爆炸危險。請只使用同類電池或制造商推薦的功能相當的電池更換原有電池。請按製造商的說明處理廢舊電池。

警告

電池更換不當會有爆炸危險。請使用製造商建議之相同或功能相當的電池更換原有電池。請按照製造商的說明指示處理廢棄舊電池。

Warnung

Bei Einsetzen einer falschen Batterie besteht Explosionsgefahr. Ersetzen Sie die Batterie nur durch den gleichen oder vom Hersteller empfohlenen Batterietyp. Entsorgen Sie die benutzten Batterien nach den Anweisungen des Herstellers.

Attention

Danger d'explosion si la pile n'est pas remplacée correctement. Ne la remplacer que par une pile de type semblable ou équivalent, recommandée par le fabricant. Jeter les piles usagées conformément aux instructions du fabricant.

¡Advertencia!

Existe peligro de explosión si la batería se reemplaza de manera incorrecta. Reemplazar la batería exclusivamente con el mismo tipo o el equivalente recomendado por el fabricante. Desechar las baterías gastadas según las instrucciones del fabricante.

אזהרה!

קיימת סכנת פיצוץ של הסוללה במידה והוחלפה בדרך לא תקינה. יש להחליף את הסוללה בסוג התואם מחברת יצרן מומלצת. סילוק הסוללות המשומשות יש לבצע לפי הוראות היצרן.

هناك خطر من انفجار في حالة اسبدال البطارية بطريقة غير صحيحة فعلياً
اسبدال البطارية فقط بنفس النوع أو ما يعادلها مما أوصت به الشركة المصنعة
جخلص من البطاريات المسحمة وفقاً لتعليمات الشركة الصانعة

경고!

배터리가 올바르게 교체되지 않으면 폭발의 위험이 있습니다. 기존 배터리와 동일하거나 제조사에서 권장하는 동등한 종류의 배터리로만 교체해야 합니다. 제조사의 안내에 따라 사용된 배터리를 처리하여 주십시오.

Waarschuwing

Er is ontploffingsgevaar indien de batterij verkeerd vervangen wordt. Vervang de batterij slechts met hetzelfde of een equivalent type die door de fabrikant aanbevolen wordt. Gebruikte batterijen dienen overeenkomstig fabrieksvoorschriften afgevoerd te worden.

Product Disposal



Warning! Ultimate disposal of this product should be handled according to all national laws and regulations.

製品の廃棄

この製品を廃棄処分する場合、国の関係する全ての法律・条例に従い処理する必要があります。

警告

本产品的废弃处理应根据所有国家的法律和规章进行。

警告

本產品的廢棄處理應根據所有國家的法律和規章進行。

Warnung

Die Entsorgung dieses Produkts sollte gemäß allen Bestimmungen und Gesetzen des Landes erfolgen.

¡Advertencia!

Al deshacerse por completo de este producto debe seguir todas las leyes y reglamentos nacionales.

Attention

La mise au rebut ou le recyclage de ce produit sont généralement soumis à des lois et/ou directives de respect de l'environnement. Renseignez-vous auprès de l'organisme compétent.

סילוק המוצר

אזהרה!

סילוק סופי של מוצר זה חייב להיות בהתאם להנחיות וחוקי המדינה.

عند التخلص النهائي من هذا المنتج ينبغي التعامل معه وفقا لجميع القوانين واللوائح الوطنية

경고!

이 제품은 해당 국가의 관련 법규 및 규정에 따라 폐기되어야 합니다.

Waarschuwing

De uiteindelijke verwijdering van dit product dient te geschieden in overeenstemming met alle nationale wetten en reglementen.

Appendix D

UEFI BIOS Recovery

Warning: Do not upgrade the BIOS unless your system has a BIOS-related issue. Flashing the wrong BIOS can cause irreparable damage to the system. In no event shall Supermicro be liable for direct, indirect, special, incidental, or consequential damages arising from a BIOS update. If you need to update the BIOS, do not shut down or reset the system while the BIOS is updating to avoid possible boot failure.

D.1 Overview

The Unified Extensible Firmware Interface (UEFI) provides a software-based interface between the operating system and the platform firmware in the pre-boot environment. The UEFI specification supports an architecture-independent mechanism that will allow the UEFI OS loader stored in an add-on card to boot the system. The UEFI offers clean, hands-off management to a computer during system boot.

D.2 Recovering the UEFI BIOS Image

A UEFI BIOS flash chip consists of a recovery BIOS block and a main BIOS block (a main BIOS image). The boot block contains critical BIOS codes, including memory detection and recovery codes for the user to flash a new BIOS image if the original main BIOS image is corrupted. When the system power is first turned on, the boot block codes execute first. Once this process is completed, the main BIOS code will continue with system initialization and the remaining POST (Power-On Self-Test) routines.



Note 1: Follow the BIOS recovery instructions below for BIOS recovery when the main BIOS boot crashes.

Note 2: When the BIOS boot block crashes, you will need to follow the procedures to make a Returned Merchandise Authorization (RMA) request. (For a RMA request, please see section 3.5 for more information). Also, you may use the Supermicro Update Manager (SUM) Out-of-Band (OOB) (https://www.supermicro.com.tw/products/nfo/SMS_SUM.cfm) to reflash the BIOS.

D.3 Recovering the BIOS Block with a USB Device

This feature allows the user to recover a BIOS image using a USB-attached device without additional utilities used. A USB flash device such as a USB Flash Drive, or a USB CD/DVD ROM/RW device can be used for this purpose. However, a USB Hard Disk drive cannot be used for BIOS recovery at this time.

The file system supported by UEFI is FAT (including FAT12, FAT16, and FAT32) which is installed on a bootable or non-bootable USB-attached device. However, the BIOS might need several minutes to locate the SUPER.ROM file if the media size becomes too large due to the huge volumes of folders and files stored in the device.

To perform UEFI BIOS recovery using a USB-attached device, follow the instructions below.

1. Using a different machine, copy the "Super.ROM" binary image file into the disc Root "\\" directory of a USB device or a writable CD/DVD.

 **Note:** If you cannot locate the "Super.ROM" file in your driver disk, visit our website at www.supermicro.com to download the BIOS image into a USB flash device and rename it "Super.ROM" for BIOS recovery use.

2. Insert the USB device that contains the new BIOS image ("Super.ROM") into your USB drive and power on the system
3. While powering on the system, please keep pressing <Ctrl> and <Home> simultaneously on your keyboard *until the following screen (or a screen similar to the one below) displays.*

Warning: Please **stop** pressing the <Ctrl> and <Home> keys immediately when you see the screen (or a similar screen) below; otherwise, it will trigger a system reboot.



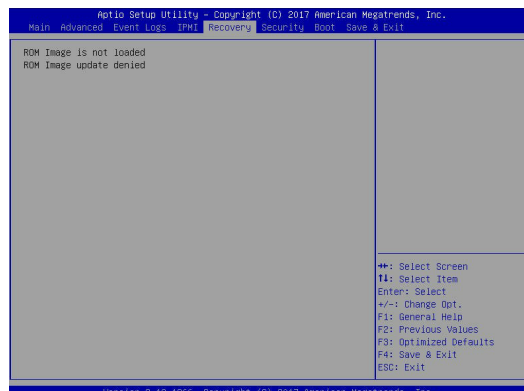

SYSTEM INSTALLING... BMC DP10.102.160.120 F1

 **Note:** On the other hand, if the following screen displays, please load the "Super.ROM" file to the root folder and connect this folder to the system. (You can do so by inserting a USB device that contains the new "Super.ROM" image to your machine for BIOS recovery.)

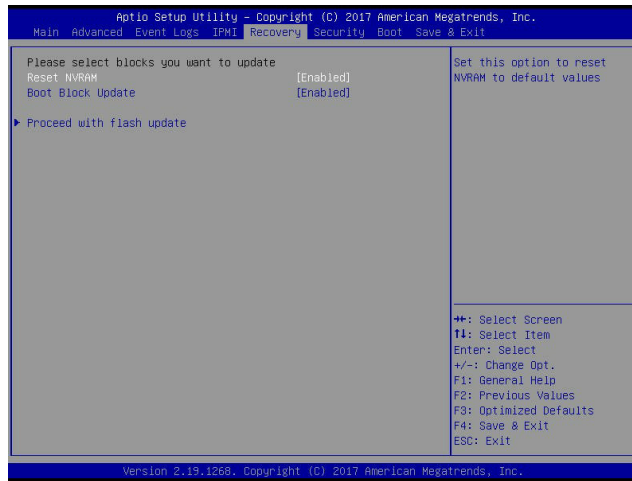

- After locating the new BIOS binary image, the system will enter the BIOS Recovery menu as shown below.



 **Note:** At this point, you may decide if you want to start the BIOS recovery. If you decide to proceed with BIOS recovery, follow the procedures below.

- When the screen as shown above displays, use the arrow keys to select the item "Proceed with flash update" and press the <Enter> key. You will see the BIOS recovery progress as shown in the screen below.

 **Note:** Do not interrupt the BIOS flashing process until it has completed.

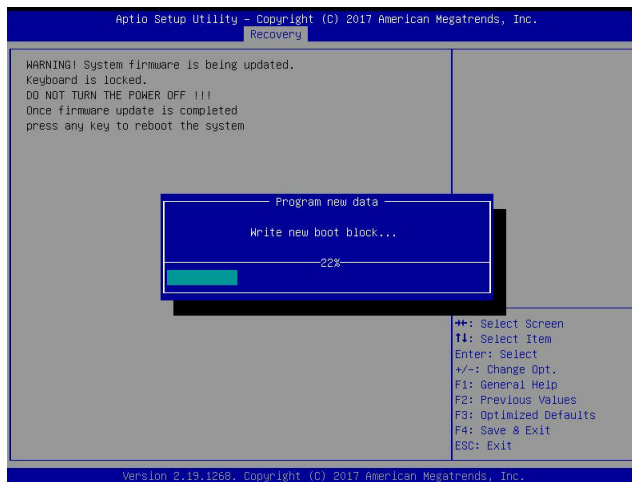

6. After the BIOS recovery process is completed, press any key to reboot the system.

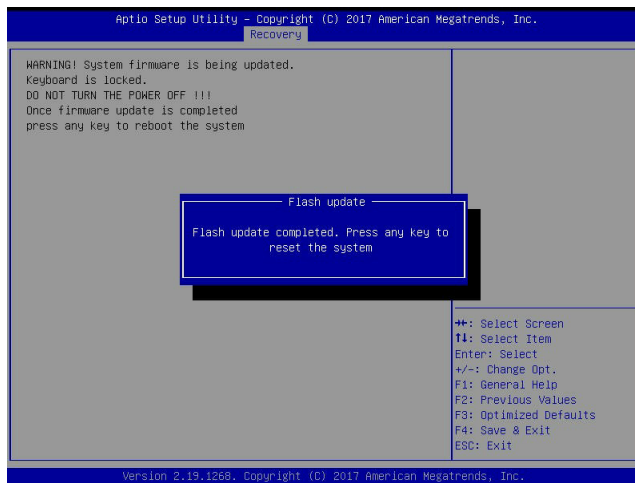

7. Using a different system, extract the BIOS package into a USB flash drive.
8. Press continuously during system boot to enter the BIOS setup utility. From the top of the tool bar, click on Boot and press <Enter> to enter the submenu. From the submenu list, select Boot Option #1 as shown below. Then, boot Option #1 to [UEFI AP:UEFI: Built-in EFI Shell]. Press <F4> to save the settings and exit the BIOS setup utility.

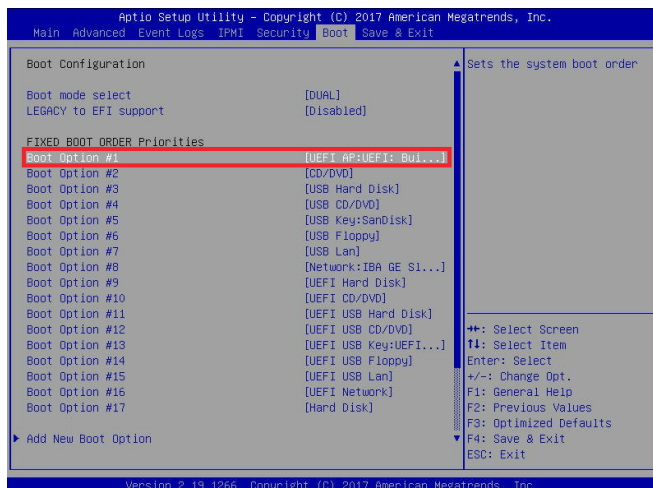

- When the UEFI Shell prompt appears, type `fs#` to change the device directory path. Go to the directory that contains the BIOS package you extracted earlier from Step 7. Enter `flash.nsh BIOSname.###` at the prompt to start the BIOS update process.

```

UEFI Interactive Shell v2.1
EDK II
UEFI v2.50 (American Megatrends, 0x0005000C)
Mapping table
  FS0: Alias(s):HD0:0B:BLK1:
      PciRoot(0x0)/Pci(0x14,0x0)/USB(0x11,0x0)/HD(1,MBR,0x37910122,0x800,0x1
DR9592)
  BLK0: Alias(s):
      PciRoot(0x0)/Pci(0x14,0x0)/USB(0x11,0x0)
Press F8 in 1 seconds to skip startup.nsh or any other key to continue.
Shell: fs#
FS0:\> cd AFUDOS
FS0:\AFUDOS> cd SNIJME2_03162017
FS0:\AFUDOS\SNIJME2_03162017> flash.nsh X11DPU7_314
    
```



Note: Do not interrupt this process until the BIOS flashing is complete.

```

Done.
[ Access Cmos Port Ex ]
<Read>
Index 0x51: 0x10

Done.
*****
* Program BIOS and ME (including FDT) regions...
*****
| AMT Firmware Update Utility v5.09.01.1917
| Copyright (C)2017 American Megatrends Inc. All Rights Reserved.
|-----|
CPUID = 50652

Reading flash ..... done
- ME Data Size checking - ok
- FFS checksums ..... ok
- Check RomLayout ..... Ok
Erasing Boot Block ..... done
Updating Boot Block ..... done
Verifying Boot Block ..... done
Erasing Main Block ..... 0x00132000 (0x)
    
```

- The screen above indicates that the BIOS update process is completed. When you see the screen above, unplug the AC power cable from the power supply, clear CMOS, and plug the AC power cable in the power supply again to power on the system.

```

Verifying NDB Block ..... done
- Update success for FDR
- Update success for IE
- Successful Update Recovery Loader to OPRx11
- Successful Update MFSB11
- Successful Update FPR11
- Successful Update MFS, IVBI and IVB211
- Successful Update FLOG and UTDK11
- ME Entire Image update success !!
WARNING : System must power-off to have the changes take effect!
Moving FS0:\AFUDOS\SNIJME2_03162017\Fdtv64.efi -> FS0:\AFUDOS\SNIJME2_03162017\F
dt1.smc
- [ok]
Moving FS0:\AFUDOS\SNIJME2_03162017\Fuef1x64.efi -> FS0:\AFUDOS\SNIJME2_0316201
7\Fuef1.smc
- [ok]
*****
* Please ignore this 'Shell: Cannot read from file - Device Error'
* warning message due to it does not impact flashing process.
*****
Deleting "C:\uefi\boot\rom"
Delete successful.
FS0:\>
    
```

- Press `` continuously to enter the BIOS setup utility.
- Press `<F3>` to load the default settings.
- After loading the default settings, press `<F4>` to save the settings and exit the BIOS setup utility.