

TANDBERG DATA

Securing your Information



StorageLibrary T40+ Series

Installation and User Guide

Revision 433599-06
2012-07-18

Copyright © 2012 Tandberg Data GmbH

The information contained in this document is subject to change without notice.

This document contains proprietary information which is protected by copyright. All rights are reserved. No part of this document may be reproduced, modified, distributed, or translated to another language without the prior written consent of Tandberg Data.

Tandberg Data Norge
Lorenveien 68
N-0580 Oslo, Norway
www.tandbergdata.com

This document may describe designs for which patents are pending, or have been granted. By publishing this information, Tandberg Data conveys no license under any patents or any other rights.

Tandberg Data does not accept liability for errors contained herein or for incidental or consequential damages (including lost profits) in connection with the furnishing, performance or use of this material whether based on warranty, contract, or other legal theory. Tandberg Data makes no representation or warranty with respect to the contents of this document and specifically disclaims any implied warranties of merchantability or fitness for any particular purpose. Further, Tandberg Data reserves the right to revise or change this document without obligation on the part of Tandberg Data to notify any person or organization of such revision or change.

Every effort has been made to acknowledge trademarks and their owners. All trademarks within this document are the property of their respective owners. Trademarked names are used solely for identification or exemplary purposes, and any omissions are unintentional.

Published: July 2012

Part No.: 433599-06

Table of Contents

1 About This Guide	11
Waste Electrical and Electronic Equipment Directive	11
Regulatory Name	11
Explanation of Symbols and Notes	11
Other Documents You May Need	12
Getting More Information or Help.....	12
International Headquarter	12
Technical Support.....	12

2 Product Overview	13
Product Description	14
Tape Drive Support	14
Data Transfer Rates	14
Magazines	14
Front Panel	14
Rear Panel.....	15
Library Features	17
Operator Interfaces.....	17
ADI Bridging and LUN	17
Partitions	17
Control Path.....	17
I/E Station	17
Simple Network Management Protocol (SNMP)	17
Capacity on Demand (COD).....	17
Pass-Thru Upgrade	18
Redundant Power Supply.....	18
Browser Requirements	18

3 Unpacking the StorageLibrary	19
Finding a Location for the StorageLibrary.....	19
Unpacking	19

4 Hardware Installation	21
Preparing for Installation	22
Installing one or more StorageLibrary Product(s) in a Rack	22
Remove the Transport Locking Screws	33
Mounting the Rack mount Ears.....	34
Installing the Library Cables.....	35
Connecting SCSI Cables.....	35

Connecting SAS Cables	36
Connecting Fibre Channel Cables.....	37
System Power-on.....	38
Labeling Cartridges for the Barcode Reader	39

5 Operator Interfaces 41

Front Panel Interface (FPI).....	41
Scroll Function	41
Remote Management Interface (RMI)	42
Menu Trees	42
Home Screen	45
Operator Privileges	45
Words Commonly Used on the FPI and the RMI.....	46

6 Configuring the Library 49

About the Setup Wizard	49
Using the Default Administrative User Account (Administrator)	49
Using the Setup Wizard	50
Setup Wizard Tasks	50
Applying a License Key.....	52
Configuring Pass-Thru	52
Configuring I/E Slots	52
Configuring Cleaning Slots.....	53
Configuring Auto Clean	54
Configuring Partitions	54
Creating Partitions	54
Re-configuring Partitions	55
Changing Partition Modes	55
Setting Drive ID.....	56
Modifying the Control Path	57
Configuring Menu Timeout.....	57
Setting Date and Time	57
Configuring Barcode Scan	58
Configuring Audible Alarm	58
Configuring Network Settings.....	58
Remote Access.....	59
Configuring FPI Password	59
Configuring RMI Password	59
Configuring SNMP	60
Configuring Notifications	60
Severity Level	60
Configuring E-mail Notification	61

7 Running the Library 63

Logging In.....	63
Logging Out.....	63
Importing Cartridges.....	63
Importing Cartridges via I/E Slot.....	64
Import Cartridges via Bulk Loading of Magazines.....	65
Exporting Cartridges	65
Loading to Tape Drives	65
Unloading from Tape Drives	65
Cleaning Tape Drives.....	66
Importing Cleaning Media.....	66
Cleaning Media Handling	66
Exporting Cleaning Media	66

Auto Clean	66
Manual Clean.....	67
Taking a Library Online/Offline.....	67
Taking a Library Online	67
Taking a Library Offline	67
Magazine Handling	67
Using the Mail Slot.....	67
Removing the Magazine from the Unit	68
Inserting Cartridges into the Magazine.....	68
Removing Cartridges from the Magazine.....	69
Inserting a Magazine into the Unit	69
Manual/Emergency Release of Magazines	69
Standby Functionality.....	70

8 Getting Status and Information 71

Library Settings	71
Partition and Drive Information.....	71
Network	72
Statistics.....	73
Event Log.....	73

9 Adding, Removing and Replacing 75

Power Supply Unit.....	75
Replacing a Power Supply	76
Adding a Redundant Power Supply.....	77
Hot-Swapping a Redundant Power Supply	78
Tape Drive Unit	79
Adding a Tape Drive	79
Permanently Removing a Tape Drive	79
Removing and Replacing a Tape Drive.....	80

10 Updating Firmware 81

Updating Library Firmware.....	81
Updating Drive Firmware	82

11 Working With Cartridges and Barcodes 85

Handling Cartridges Properly	85
Write-Protecting Cartridges.....	86
Barcode Requirements	86
Attaching Barcode Labels	86

12 Troubleshooting 87

About RAS Tickets	87
Viewing RAS Tickets	87
Closing RAS Tickets.....	88
Supported RAS Tickets	88
Interpreting LEDs	93
The Maintenance Menu	93
The Diagnostics Menu	93
Verifying Hardware.....	94
Software Checking	94
Verifying Recent Changes	94
Troubleshooting Matrix.....	95

13 Shipping or Transporting the StorageLibrary	101
Re-inserting the Transport Locking Screws	101
Packing the StorageLibrary.....	102

14 Specifications	103
Library Dimensions	105
Library Component Weights.....	105
Power Requirements.....	106
Climatic Specifications	106

15 Safety and Regulatory Information	107
Safety Approvals	107
EMC Approvals	107
Conformity Declarations.....	108

16 Approved Drive Types	109
--------------------------------	------------

Figures

Figure 1. Front Panel of the StorageLibrary	15
Figure 2. Rear Panel of the StorageLibrary with 1 full-height SCSI Drive Installed	16
Figure 3. Two T40+ units mounted in a rack	21
Figure 4. Position of the Rack Installation Stencil (Front View).....	25
Figure 5. Matching the Hole-set	25
Figure 6. Position of the Rack Installation Stencil (Rear View)	26
Figure 7. Aligning of the Rack Installation Stencils for systems with more than two units	26
Figure 8. The Rail Assemblies	27
Figure 9. Screw Mounting Sequence (Front View)	27
Figure 10. Rear View of the Rack	28
Figure 11. Rack-Ear Mounting Holes	28
Figure 12. Remove the top blanking plate of the lower-most unit	29
Figure 13. Remove the bottom blanking plate of the upper-most unit.....	29
Figure 14. Slide the units onto the rails, leaving ~100mm for ear mounting.....	30
Figure 15. Remove the transport locking screws.....	30
Figure 16. Mount the ears on the side of the units	31
Figure 17. Ear screws mounting sequence	31
Figure 18. Install the Pass-Thru box in the Pass-Thru magazine	32
Figure 19. Exchange the right lower-most magazine with the Pass-Thru magazine in all the units except the upper most unit ..	32
Figure 20. The Complete System	33
Figure 21. Transport Locking Screws Marked with Red Plastic Tabs	33
Figure 22. Mounting the Rack Mount Ears	34
Figure 23. StorageLibrary Cabling (SCSI interface)	35
Figure 24. StorageLibrary Cabling (SAS interface).....	36
Figure 25. StorageLibrary Cabling (Fibre Channel interface).....	37
Figure 26. Positioning of Barcode Label for LTO Cartridges	39
Figure 27. Available Tandberg Data Cartridge Labels.....	39
Figure 28. Front Panel Interface (FPI) Top Level Menu Tree	43
Figure 29. Remote Management Interface (RMI) Top Level Menu Tree.....	44
Figure 30. Remote Management Interface Home Screen	45
Figure 31. Maps Menu on the FPI.....	47
Figure 32. Removing a Magazine from the Library.....	68
Figure 33. Inserting a Cartridge into the Magazine Slot.....	68
Figure 34. Ejecting a Cartridge from the Magazine Slot.	69
Figure 35. Inserting a Magazine into the Unit.....	69
Figure 36. Ejecting a Magazine using the Emergency Release Tool.....	70
Figure 37. The Back of the Library	75
Figure 38. Replacing a Power Supply	76
Figure 39. Adding a second Power Supply	77
Figure 40. Hot-Swapping a Power Supply.....	78
Figure 41. Adding or Removing a Tape Drive	80
Figure 42. Cartridge Write-Protect Switch and Correct Label Location.....	86
Figure 43. Transport Locking Screws Marked with Red Plastic Tab.....	102
Figure 44. The StorageLibrary partly packed	102

Tables

Table 1. Data Transfer Rates.....	14
Table 2. Commonly Used Words on FPI and RMI.....	46
Table 3. Cartridge Present Symbols on FPI during Inventory and in the Maps Menu	46
Table 4. Supported RAS Tickets.....	88
Table 5. Maintenance Menus - Item Name and Description.....	93
Table 6. Diagnostics Menu - Item Name and Description.....	93
Table 7. Troubleshooting Matrix - Power with Solution.....	95
Table 8. Troubleshooting Matrix - Cartridge Movement with Solution.....	96
Table 9. Troubleshooting Matrix - Media with Solution.....	97
Table 10. Troubleshooting Matrix - SCSI with Solution	97
Table 11. Troubleshooting Matrix - Library Performance with Solution.....	98
Table 12. Troubleshooting Matrix - Cleaning with Solution.....	98
Table 13. Troubleshooting Matrix - Write or Read Issues with Solution.....	99
Table 14. Troubleshooting Matrix - LED Error Messages with Solutions	99
Table 15. Troubleshooting Matrix - Errors Displayed on Front Panel with Solution.....	100
Table 16. Troubleshooting Matrix - Remote Management with Solution.....	100
Table 17. Troubleshooting Matrix - Forgot Password with Solution	100
Table 18. Library Specification Summary.....	103
Table 19. Library Dimensions	105
Table 20. Library Component Weights.....	105
Table 21. Library Power Requirements.....	106
Table 22. Temperature Range	106
Table 23. Humidity Range	106
Table 24. Altitude Range	106
Table 25. Approved Drive Types and Compatible Cartridges.....	109

1

About This Guide

This guide contains information and instructions necessary for the normal operation and management of the Tandberg Data StorageLibrary T40+ Series. It is intended for anyone interested in learning or needing to know how to install, configure, and operate the StorageLibrary T40+ Series. Please note that Administrator level privileges are required in order to configure many of the features described in this guide.



Note

Be sure to read all operating instructions in this manual before operating this product.

Waste Electrical and Electronic Equipment Directive

This product contains materials that are recyclable under the Waste Electrical and Electronic Equipment (WEEE) directive of the European Union. This product should not be disposed of as unsorted municipal waste.

Regulatory Name

The Tandberg StorageLibrary T40+ Regulatory Name is: Model 1040.

Explanation of Symbols and Notes

To highlight important information, the following symbols appear throughout this document.



Caution

Indicates a situation that may cause possible damage to equipment, loss of data, or interference with other equipment.



Warning

Indicates a potentially hazardous situation which, if not avoided, could result in death or bodily injury.



Note

Indicates information intended to help you make better use of your system.

Other Documents You May Need

The following documents are also available for this product. These documents can be found at www.tandbergdata.com

- *StorageLibrary T40+ Series, Quick Installation Guide* (433559) gives you an overview of how to install the library.
- *StorageLibrary T40+ Series, Pass-Thru Installation Manual* (433831) helps you mount the StorageLibrary T40+ Series or Pass-Thru system correctly into a rack.
- *StorageLibrary T40, SCSI Functional Specification*, (433489) provides the SCSI interface specification for the Tandberg Data StorageLibrary T40.
- *StorageLibrary T40+ Series, Customer Replaceable Unit (CRU) Tape Drive Instruction* (433601).
- *StorageLibrary T40+ Series, Customer Replaceable Unit (CRU) Power Supply Instruction* (433602).

Getting More Information or Help

For further assistance please visit our web at www.tandbergdata.com or contact these regional locations:

International Headquarter

Tandberg Data GmbH,
Feldstr. 81
44141 Dortmund
Germany
Tel: +49 (0) 231 5436 - 0
Fax: +49 (0) 231 5436 - 111
www.tandbergdata.com

Technical Support

Americas

- USA and Canada: Tel: +1 303-417-7792
- South America Tel: +11-50422270 Email: suporte@tandberg.com.br

Europe

- Austria, Belgium, Czech Republic, Denmark, Finland, France, Germany, Hungary, Ireland, Italy, Norway, Poland, Portugal, Spain, Sweden, Switzerland, The Netherlands, United Kingdom*
Tel: 00800 826 323 74 (toll-free)
Or +49 (0) 231 5436-142 Email: supportemea@tandbergdata.com

Asia

- Australia Tel: 1300 309 108
- New Zealand Tel: 0800 507 560
- China, Malaysia, Philippines and Taiwan Tel: 00 800 8628 8000
- Hong Kong, Singapore, Thailand Tel: 001 800 8628 8000
- India Tel: 000 800 650 1187
- Indonesia Tel: 001 803 65 7586
- Pakistan Tel: 00 800 11065
- Sri Lanka Tel: 2430 0800*
(* Enter "2" at the voice prompt, then dial 6396 0786)
Email: support@tandberg.com.sg

2

Product Overview

The Tandberg Data StorageLibrary T40+ Series is a professional tape backup and data protection solution, providing excellent value for money. It is ideal for users who require a flexible, future-proof and reliable backup solution with scalable capacities and maximum performance at a low cost per GB.

The StorageLibrary T40+ is a compact 4U high and can be mounted in a 19" rack or used as a tabletop unit. The height of the rack mount version is 4U. The StorageLibrary T40+ contains 4 removable magazines, 40 tape slots and is available with either Half-Height (HH) or Full-Height (FH) LTO tape drives (see [Approved Drive Types](#)).

The StorageLibrary T40+ is easy to use and is designed to simplify backup operations:

- Optional Pass-Thru feature allows upto 5x units to be stacked together as one logical unit.
- Optional Redundant Power Supply.
- Four removable magazines allow easy management of data sets or archival storage.
- A user friendly operator control panel, with backlit LCD provides easy access for configuration and diagnostic operations.
- Remote management interface to operate the library remotely via a Web Browser.
- Menu Wizards for simplified library configuration.
- Integrated barcode reader.
- Support for SCSI/LVD, SAS and Fibre Channel Tape Drives.
- On-board Diagnostics and fault analysis.
- Standby functionality for power saving.
- Customer replaceable tape drives and power supplies.
- Customer upgradeable by adding tape drives, cartridge slots, and redundant power supply.



Caution

Review the Caution at the beginning of chapter [Unpacking the StorageLibrary](#) before you power up the unit for the first time.

Product Description

Tape Drive Support

For additional specification information for this model, see [Specifications](#). The drive types supported by the StorageLibrary T40+ are given in chapter [Approved Drive Types](#). The StorageLibrary T40+ supports 1-2 FH drives or 1-4 HH drives or a combination of HH and FH drives. The library supports Fibre Channel, SAS and SCSI tape drive interfaces.

Tape drives are installed into tape drive bays at the back of the library. If a tape drive bay is empty, a cover plate covers the empty tape drive bay to prevent dust from entering the library. Tape drives can be installed in any available tape drive bay.

Data Transfer Rates

Table 1. Date Transfer Rates

StorageLibrary Model	Maximum Sustained Rate, Native	Maximum Sustained Rate, Compressed
LTO-3 SCSI	80MB/s	160MB/s
LTO-3 SAS	80MB/s	160MB/s
LTO-3 FC	80MB/s	160MB/s
LTO-4 SCSI	120MB/s	240MB/s
LTO-4 SAS	120MB/s	240MB/s
LTO-4 FC	120MB/s	240MB/s

Magazines

The library is equipped with four removable magazines, all accessible from the front of the unit. The lower magazines hold 12 cartridges each and the two upper magazines hold 8 cartridges each. There are no hidden slots. To cool the library, there are air intake holes on the front bezels. For easy removal of the magazines, use the handles on the sides of the bezels. For details on magazine handling, see the section [Magazine Handling](#).

Front Panel

The Front Panel includes the Operator control panel with LCD display, four control buttons, two LED indicators and a standby switch. The bezels of the four magazines are also visible from the front. See [Figure 1](#).

LCD – Liquid Crystal Display

The display is a backlit 128 x 68, dot-matrix graphical display that can show 8 lines of 20 characters.

In various modes of operation, the display panel screens and control buttons allow you to do the following:

- Enter settings for StorageLibrary configuration.
- Issue operational commands.
- View StorageLibrary status and information.
- Test StorageLibrary functionality.

Figure 1. Front Panel of the StorageLibrary

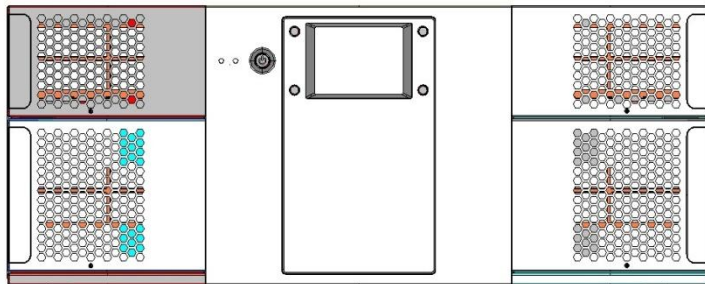

Control Buttons

The labels for the four control buttons are displayed in the corners of the LCD. All buttons have “soft function” for different modes of operation, i.e. the functions of the buttons change during different activities. The actual function for each button is always visible on the display.

LED Indicators

The two LED indicators are green and amber. They indicate the StorageLibrary activity as follows:

- Green LED on: The StorageLibrary is either running or ready for operation.
- Green LED blinking: Short blinks followed by long intervals indicate that the library is in low power standby mode.
- Amber LED on: Fault LED; the StorageLibrary has encountered an electrical or mechanical failure.

Standby Switch

A switch on the front panel provides a Library Standby mode. If the switch is pushed when the library is active, the library completes the current operation and then goes offline and enters standby mode. See [Standby Functionality](#) for more details.

Rear Panel

[Figure 2](#) show the rear panel at the back of the library.

Cooling Fans

Forced-air cooling fans are integrated in the power supply, tape drive, and behind the library control board. The fans pull air inwards through vents in the front bezels and expel it out the back. The fans start when tape drive(s) are operating or if the internal temperature becomes too high.

Main Power Switches/Fuses/Power Cord Connections

The main power switches and power connectors are located at the back of the library. The fuses in the fuse-holders are rated 250V 2A.

SCSI, SAS and Fibre Channel Interface Connectors

The library supports both SCSI, SAS and FC drives. The SCSI tape drive has two shielded 68-pin HD SCSI connectors on the rear panel. The FC tape drive has one FC connector, and the SAS drive has one SAS connector. The connectors are used for connecting the tape drive and the StorageLibrary to the host.

The FC and SAS connectors can link to the following:

- A shielded male HD68 SCSI cable

- A shielded male HD68 SCSI terminator
- SAS port cable
- FC port cable

Ethernet Port

This port is for networking in support of the Web Client. It is also used to communicate between units that share cartridges in a Pass-Thru system. It allows you to connect the StorageLibrary to a 10 BaseT compatible Ethernet network.

Battery Holder

The battery for the Real Time Clock (RTC) is located behind a plate at the back of the library. See [Figure 2](#). A drive power extension cable can be found in the same location.

Back Panel Cover plate

If a drive bay is empty, a cover plate covers the opening to prevent dust from entering the library.

Redundant Power Supply

A redundant power supply is installed in the power supply slot marked 2. See [Adding, Removing and Replacing](#) for more information.

Figure 2. Rear Panel of the StorageLibrary with 1 full-height SCSI Drive Installed

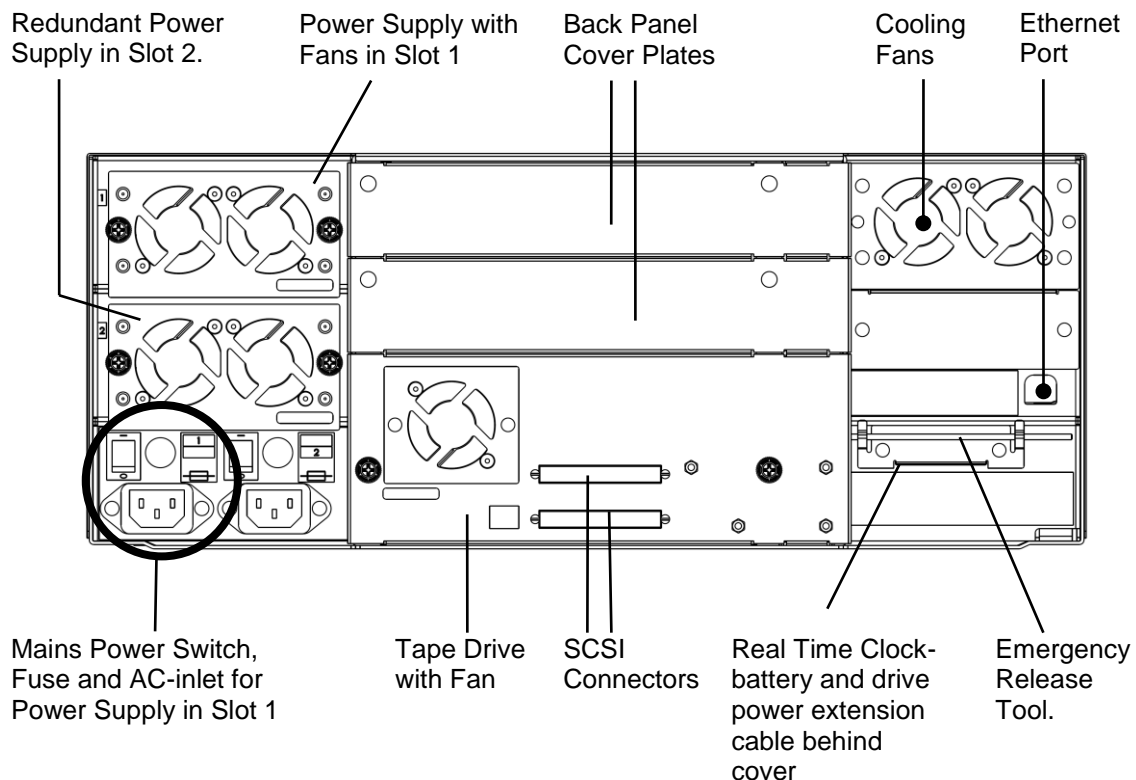

Library Features

This section describes several features of the StorageLibrary.

Operator Interfaces

The front panel is located on the front of the library and allows users to work locally on the library using the Front Panel Interface ([FPI](#)). The Web Client is a Remote Management Interface ([RMI](#)) that allows users to view and perform library functions from remote sites and is accessible through a internet browser. For more information about the front panel and the remote management interface, see [Operator Interfaces](#).

ADI Bridging and LUN

The StorageLibrary implements Automation Drive Interface (ADI) bridging with Logical Unit Numbering (LUN) addressing. The purpose of the LUN interface is to eliminate the requirement for a host interface on the library controller board. This means that the library controller does not have its own host interface, but SCSI commands to the library controller are sent via one of the installed tape drives. The tape drive and the library controller will have a common SCSI ID but different LUN numbers. The SCSI commands to/from the library controller are sent via the tape drive's ADI port.

Partitions

The partitioning feature allows users to create up to four virtual tape libraries for separating departmental data. The StorageLibrary can be divided into a maximum of four partitions. At least one tape drive and one magazine must be assigned to each partition. The robot, the import/export slots and the cleaning slots are common resources to all partitions. For more information on partitions, please see [Configuring Partitions](#).

Control Path

The "control path" tape drive is used to connect a partition to a host application. Only one tape drive can be selected as the control path at any time. By default, the first tape drive assigned to a partition is designated the control path. In the event that the control path connection to the host application fails, you may select a new control path for the partition.

I/E Station

I/E station enables the importing and exporting of cartridges without interrupting normal library operations. I/E station slots are located in either the lower left or the upper left magazine. The number of I/E slots for the 40 slot library is user settable to 0 (none), 3 or 8. The number of I/E slots for the 24 slot library is user settable to 0 (none) or 3.

The I/E slots are shared among all partitions. When a cartridge in an I/E slot is assigned to a partition, only that partition can access that I/E slot. Access to the I/E slot is managed through the front panel interface only.

Simple Network Management Protocol (SNMP)

The StorageLibrary supports system monitoring via SNMP and SNMP Notifications.

Capacity on Demand (COD)

In StorageLibrary, LTO storage slots are licensed for use. At any time, Capacity on Demand (COD) allows you to enable the unused storage slots within a library via a firmware license key. The

StorageLibrary comes with 24 slots (two lower magazines) and supports licensing of an additional 16 slots (two upper magazines).

Details about the COD license key:

- The license key does not expire.
- Once a license key is installed it cannot be removed.

To order a COD License Key, please contact our Technical Support, or open a service request. For contact information, see [Getting More Information or Help](#).

To view your library's current configuration and slot availability, open the home screen of the remote management interface.

An instruction sheet describing how to use the license key is provided in the accessory kit. Once you receive the license key, enter it via the front panel of the library. When the license key has been entered, the total number of available slots in the library increases.

Pass-Thru Upgrade

The StorageLibrary T40+ Series incorporates the new Tandberg Data automation "Pass-Thru" feature. The Pass-Thru feature allows up to five T40+ units to be stacked together in a 19" rack configuration. The Pass-Thru feature is simple to install and allows users to add additional storage capacity and drives to increase performance.

The Pass-Thru upgrade takes about 30 minutes and consists of removing the required blanking plates, installing additional T40+ units directly above the existing T40+, and re-configuring the system. After replacing the bottom right magazine with a Pass-Thru magazine, the system will briefly perform a calibration before it is ready for use. For information on how to set-up Pass-thru, please see [Configuring Pass-Thru](#).

Redundant Power Supply

The StorageLibrary T40+ is supplied with redundant power supplies. The secondary power supply is fitted to provide redundancy for mission critical operations, and to avoid power interruption to the library. Both power supplies share the load under normal operating conditions. However, if one of the power supplies fails, the other will provide the full load.

The two modular power supplies can be easily fitted and removed using thumb screws on the back of the library. The two power supplies have independent power disconnect switches to enable hot-swapping of each power supply. The auto-ranging power supplies are capable of using AC supplies between 100v and 240v. See [Adding a Redundant Power Supply](#) for replacement of power supplies.

Browser Requirements

The supported browsers include:

- Firefox™ version 1.0.6 and above
- Internet Explorer™ version 6.0 and above

3

Unpacking the StorageLibrary

This chapter provides detailed information for preparing the library location.



Caution

After the library is unpacked it needs to acclimatise for 8 hours before the power is turned on.

Finding a Location for the StorageLibrary

- The StorageLibrary must be located in a stable environment.
- The StorageLibrary is designed to operate in a horizontal position. **Do not attempt to operate the StorageLibrary in any other position than horizontally.**
- Make sure a power source is available (On StorageLibrary with redundant power you need two power sources).
- Route any cable to avoid walking on them or pinching them with items placed on or against them. Pay particular attention to the cord at the wall plug, and the point where the cord exits from the StorageLibrary.
- Make sure that objects will not fall and liquids will not spill into the chassis openings of the StorageLibrary.
- Make sure the airflow around the front and back of the StorageLibrary is not obstructed.
- Make sure there is a minimum of 60 cm (24 inch) free space in front of the unit to allow the operator to safely remove the magazines.
- Make sure the display and operator controls can easily be accessed.
- Make sure the StorageLibrary is away from the floor and in a clean environment with temperatures within specifications. See [Specifications](#).

Unpacking



Caution

You must remove the transport locking screws when powering up the unit for the first time or it will not operate. This procedure is described in the [Hardware Installation](#) chapter.

To unpack the StorageLibrary, follow the instructions below.

Carefully unpack the unit from the shipping container. Save the container and packing materials in case you need to transport the StorageLibrary in the future. The packaging is specifically designed for the library to ensure it is not damaged during transportation.

The StorageLibrary could be lifted by one person if drives, power supply, and magazines are removed. However, for absolute safety, it is recommended that two people lift the StorageLibrary. Full library weight = 38 kg / 84 lbs (2 FH drives). Empty library weight = 23.6 kg / 52 lbs (does not include drives, magazines or power supply).

Review the contents of the shipping container to be sure that all parts were included in the shipment and no parts are damaged. A standard package for the StorageLibrary consists of the following items:

- A factory-assembled StorageLibrary unit containing four cartridge magazines
- A standard accessory kit containing:
 - Printed copy of the Quick Start Guide
 - Printed copy of the T40 Mounting installation Guide.
 - 1 Warranty/Registration Information
 - Rack mounting kit including rack mount ears
 - 2 power cords: one for USA/Japan and one for European power outlets
 - 1 Ethernet cable
 - Media barcode label kit (contains media labels and cleaning cartridge labels)

There will be variations of this list. Depending on the number of drives in your library and whether or not your library is equipped with SCSI, SAS or Fibre Channel drives. The accessory kit for SCSI drives contains a terminator and SCSI cable.

The StorageLibrary accessory kit contains no cartridges.

Complete product registration online at <http://www.tandbergdata.com>, Support, Register Your Product.

4

Hardware Installation

This chapter provides the following information:

- [Preparing for Installation](#)
- [Installing one or more StorageLibrary Product\(s\) in a Rack](#)
- [Removing the Transport Locking Screws](#)
- [Mounting the Rack Mount Ears](#)
- [Installing the Library Cables](#)
- [Labeling Cartridges for the Barcode Reader](#)

 **Caution** You must remove the transport locking screws when powering up the unit for the first time, or it will not operate.

 **Caution** The StorageLibrary T40+ has blanking plates on the top and bottom cover. Do NOT remove any blanking plates before instructed to do so. Some of the blanking plates are removed if two or more units are used in a Pass-Thru system.

Figure 3. Two T40+ units mounted in a rack

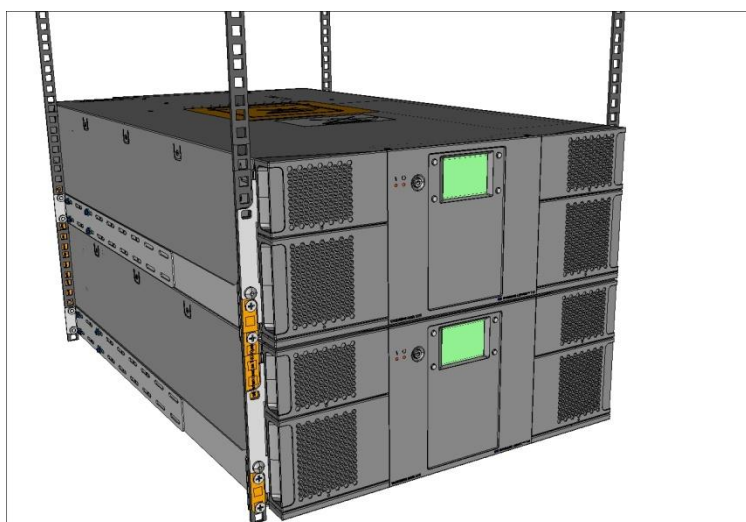

Preparing for Installation

The procedures for mounting the unit(s) in a rack are described in this chapter and consist of 3 main steps: (A) Preparing the Rack Rail Assemblies and positioning them before mounting them in a Rack, (B) Preparing the unit(s) to be mounted, and (C) Mounting the unit(s) into the rack.

The StorageLibrary unit is designed for use in a 19" rack system, using 4U of rack space and special rack mount rail assemblies. It is also designed to operate in a horizontal position. Do not attempt to operate the StorageLibrary in any other position than horizontally. Also make sure that:

- The airflow around the front and back of the StorageLibrary is not obstructed.
- There is a minimum of 60 cm (24 inch) free space in front of the unit to allow the operator to safely remove the magazines.
- The display and operator controls can easily be accessed.
- The StorageLibrary is away from the floor and in a clean environment, with temperatures within defined specifications. For specifications and safety information, see [Specifications](#) and [Safety and Regulatory Information](#).
- The length of the power cord and the primary interface cables restrict the placement.

Please make sure that the Rack Mounting Kit contains the following items:

- Two Rack Mount Ears
- One Left Rail Assembly
- One Right Rail Assembly
- Four Rack Installation Stencils.
- Eight M3x4 Screws.
- Two M6x12 Pan Head Screws
- Eight M6x12 Countersink Screws.

Installing one or more StorageLibrary Product(s) in a Rack

The purpose of these instructions is to help you mount the StorageLibrary T40+ Series / Pass-Thru system correctly into a rack, using the special rack assemblies included with the unit(s). Follow the same mounting instructions and drawings when increasing the number of units from 2 to 3, or 3 to 4, and so on. The correct vertical distance in the rack, between pairs of units, is obtained by using a special rack installation stencil. This stencil allows the rail mounting screws to only pass thru its punched holes.

Steps 1 to 4 are identical for both the stand-alone and the Pass-Thru option. For the steps explaining the preparation of the unit(s) (steps 4-14), the text description will differ between the stand-alone option and the Pass-Thru option.

STEP A: RAIL MOUNTING INTO A RACK

- 1) Position the rack installation stencil on the rack in 4 places as shown in [Figure 4](#) and [Figure 6](#). The two rear stencils are optional. The stencils must be positioned on the rack at the same vertical distance from the bottom of the rack.
(NOTE: The holes in a standard rack are NOT evenly distributed. Make sure that the holes in the stencil fully match the hole-set, see [Figure 5](#). Also make sure that the stencil is placed with the single hole downwards, and the double hole upwards).
The holes and the text on the stencil ensure the correct vertical position for the rails of one pair of units. If the system contains more than 2 units, repeat the stencil attachment with the appropriate number of stencils, see [Figure 7](#).

- 2) If necessary, adjust the Left and Right rail set according to the length of the Rack to be used. See illustration of the rail set in [Figure 8](#).
Rack size ≤ 800 mm: Always use the hole-set close to the rear of the adjustable / sliding part of the rail assembly. The second hole-set to be used should be 100mm from the rear hole-set.
Rack size > 800 mm: Use the hole-set closest to the rear of the stationary part of the rail assembly. The distance between this hole-set and the next one to be used should be 100 mm. This will ensure optimum rail stiffness. See [Figure 8](#).
- 3) Mount the rails on the Rack by attaching the rails with the screws thru the marked holes on the stencil (see [Figure 9](#), [Figure 10](#), and [Figure 11](#)).
NOTE: Follow the numbered screw-mounting sequence in [Figure 9](#) and use the eight M6x12mm countersink screws for this operation (for each set of rails).
- 4) Repeat this Rail Mounting Sequence for all units.

STEP B: PREPARING THE UNIT(S) TO BE MOUNTED:

- 5) **Pass-Thru Option:** (NOTE: Skip this step if you are using the **stand-alone option**.) Remove the appropriate blanking plates on the two units as shown in [Figure 12](#) and [Figure 13](#). The holes are normally blinded, and by removing the blanking plate the unit will have a physical hole in the top plate or the bottom plate, or both top & bottom plates. If the unit is the lower-most (**Master Library**) in the new combined structure, only the top plate is removed (see [Figure 12](#)). If the unit is the upper-most (**Add-on Library**) in the new combined structure, only the bottom plate is removed (see [Figure 13](#)). If the unit is in-between two other units, both top and bottom plates are removed.



Caution

Make sure you do not remove any blanking plates when you install a stand-alone system.



Caution

Remove only the upper blanking plate of the lower-most unit (Master Library), the top blanking plate of the upper-most unit (Add-On Library) of the combined system. For units in-between the upper and lower-most unit, remove both blanking plates. Make sure you do not remove any other blanking plates.

STEP C: MOUNTING THE UNIT(S) INTO THE RACK

- 6) Slide the unit(s) onto the rails, leaving a space of approximately 100mm for later ear rack mounting (step 11). See [Figure 14](#).
- 7) Connect the power cable(s) to the unit(s). If using the redundant power supply option connect both power inlets on the unit(s). Otherwise connect one of the power outlets on the unit(s). Switch on the corresponding power switch on the unit(s).
- 8) The library detects that the transport locking screws are present. Follow the instructions on the front panel display to remove all the magazines and obtain access to the locking screws.



Caution

Be careful not to drop any of the transport locking screws inside the unit.

- 9) Remove the four transport locking screws on each unit as shown in [Figure 15](#). If necessary, see [Remove the Transport Locking Screws](#) for a detailed description.
- 10) Mount the Ears on the sides of each unit. Use the eight M3x4mm countersink screws included with each unit. See [Figure 16](#) and [Mounting the Rack mount Ears](#) for further details.
- 11) Slide the unit(s) fully into the rack and fasten them by mounting the ears to the rack using the two M6x12mm pan-head screws per unit (see [Figure 17](#)).
NOTE: mount the screw on the left side before the right side in order to give the correct sideways orientation of the unit.
- 12) Connect the unit's Ethernet cable.

- 13) Connect Drive cables according to section [Installing the Library Cables](#).
- 14) Follow the Setup Wizard in the display for setting up the system. You may re-configure the library at a later stage if necessary. Please refer to [Configuring the Library](#) for more information.
- 15) **Pass-Thru Option:** Put the Pass-Thru box into the Pass-Thru magazine (see [Figure 18](#), [Figure 19](#) and [Figure 20](#)). Exchange the original T40 LOWER RIGHT MAGAZINE with the PASS-THRU MAGAZINE (with the Pass-Thru box inserted) and slide it into the **LOWER UNIT's** right lower magazine opening. Re-insert the three other magazines. Repeat for all units except the upper unit. Re-insert all the **original magazines on the upper unit**. The system will now run the inventory sequence and perform calibration of the unit(s), and it is ready for use. Continue configuring the library. Please refer to [Configuring the Library](#) for more information.

Stand-alone Option: Re-insert all four magazines as-is.

The system will now run the inventory sequence and perform calibration of the unit(s), and it is ready for use. Continue configuring the library. Please refer to [Configuring the Library](#) for more information.



You must remove the transport locking screws when powering up the unit for the first time, or it will not operate.

Figure 4. Position of the Rack Installation Stencil (Front View)

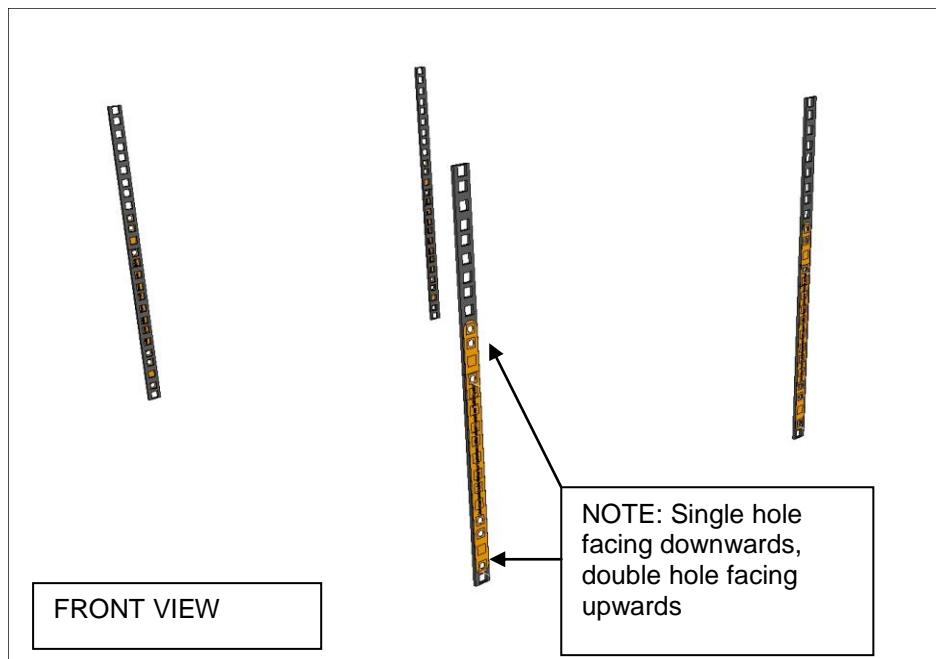

Figure 5. Matching the Hole-set

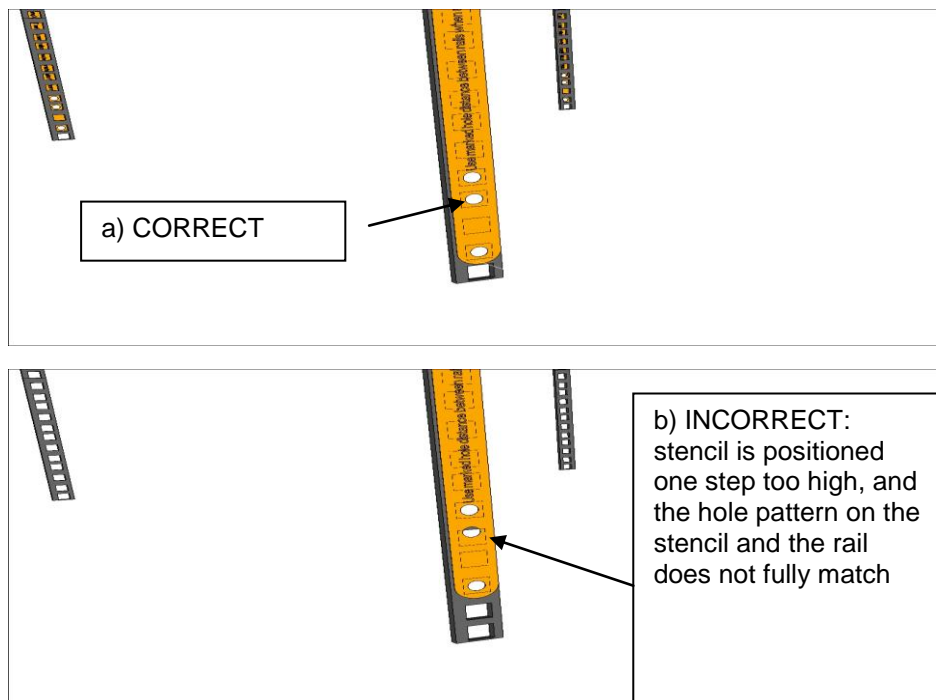

Figure 6. Position of the Rack Installation Stencil (Rear View)

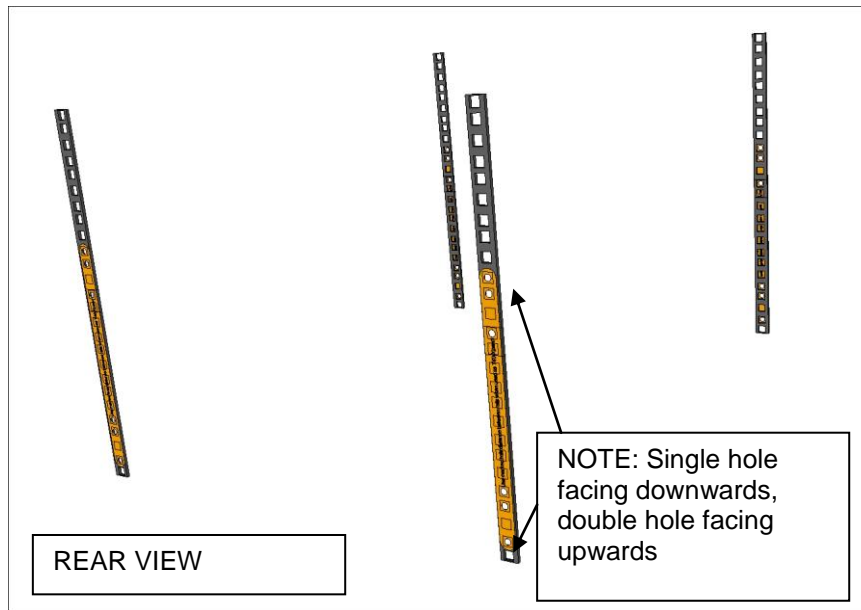

Figure 7. Aligning of the Rack Installation Stencils for systems with more than two units



Figure 8. The Rail Assemblies

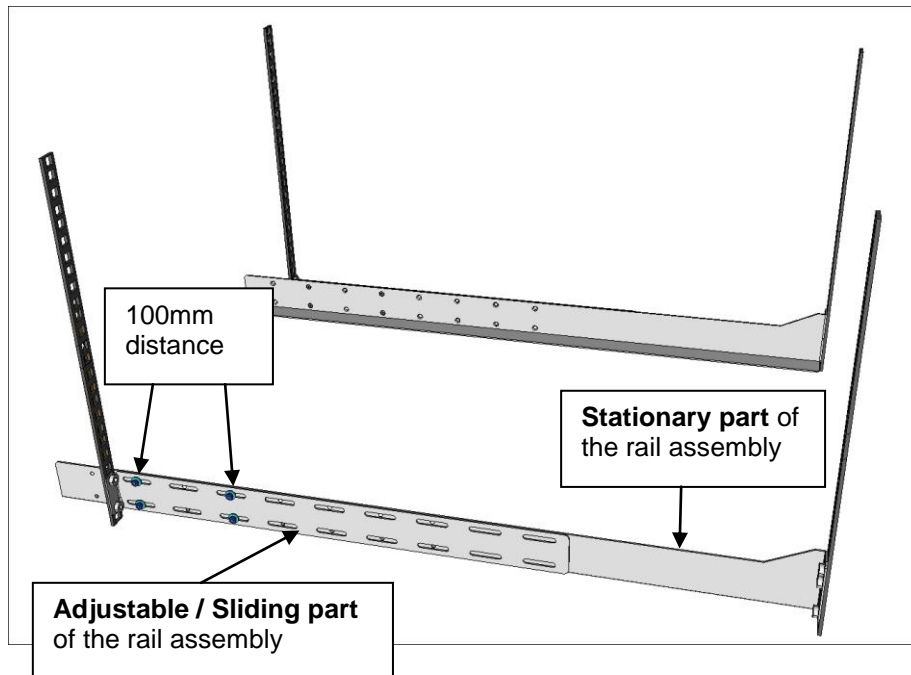

Figure 9. Screw Mounting Sequence (Front View)

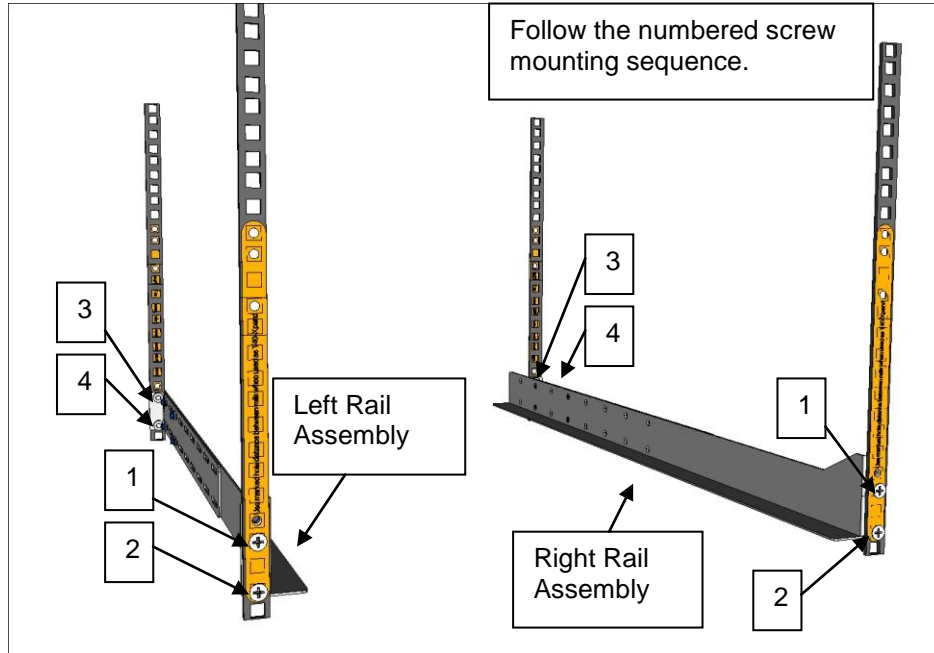

Figure 10. Rear View of the Rack

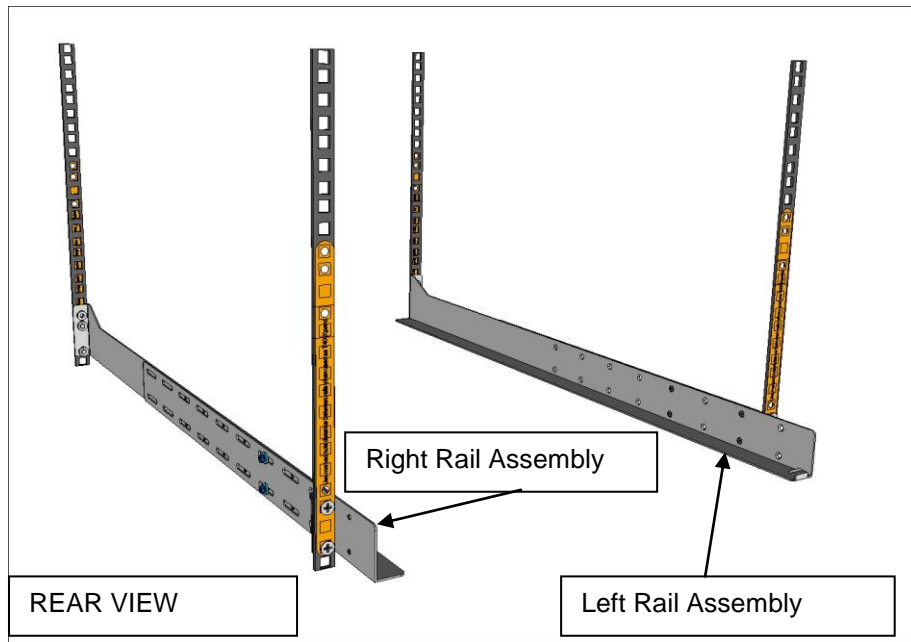
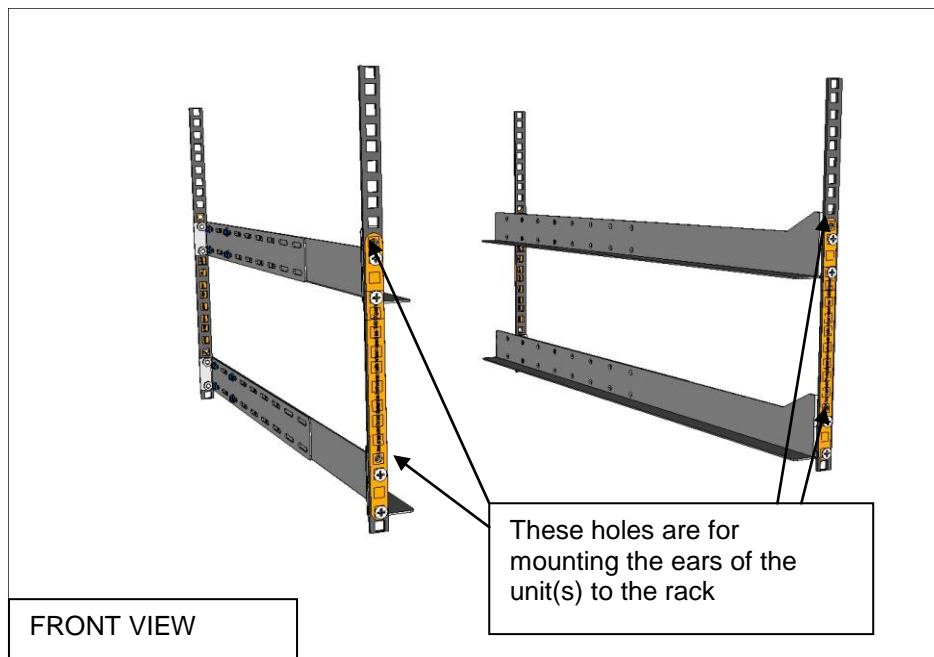
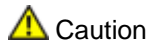

Figure 11. Rack-Ear Mounting Holes





Caution

Remove only the upper blanking plate of the lower-most unit (Master Library), the top blanking plate of the upper-most unit (Add-On Library) of the combined system. For units in-between the upper and lower-most unit, remove both blanking plates. Make sure you do not remove any other blanking plates.

Figure 12. Remove the top blanking plate of the lower-most unit

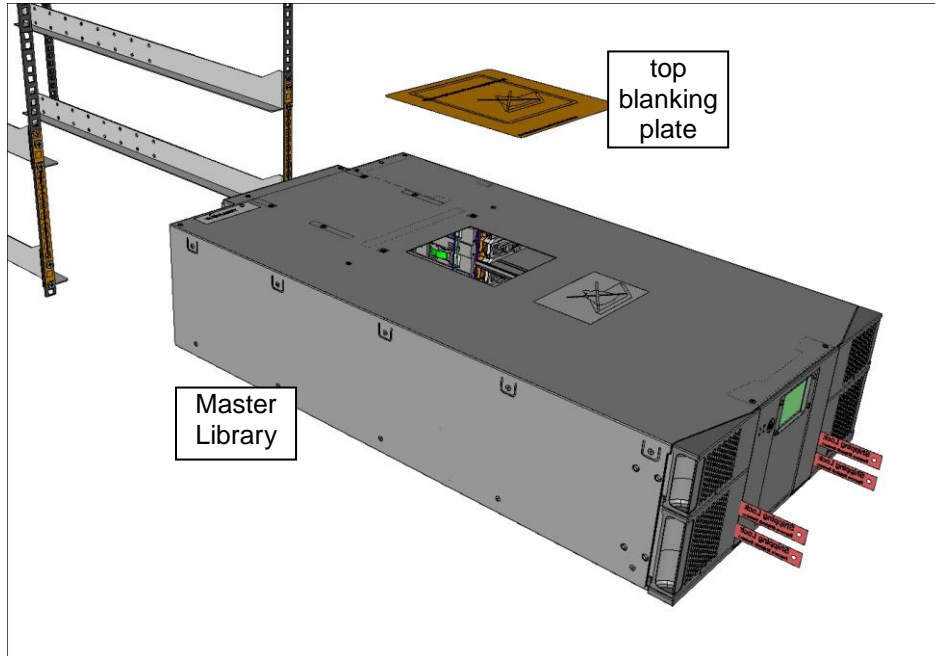
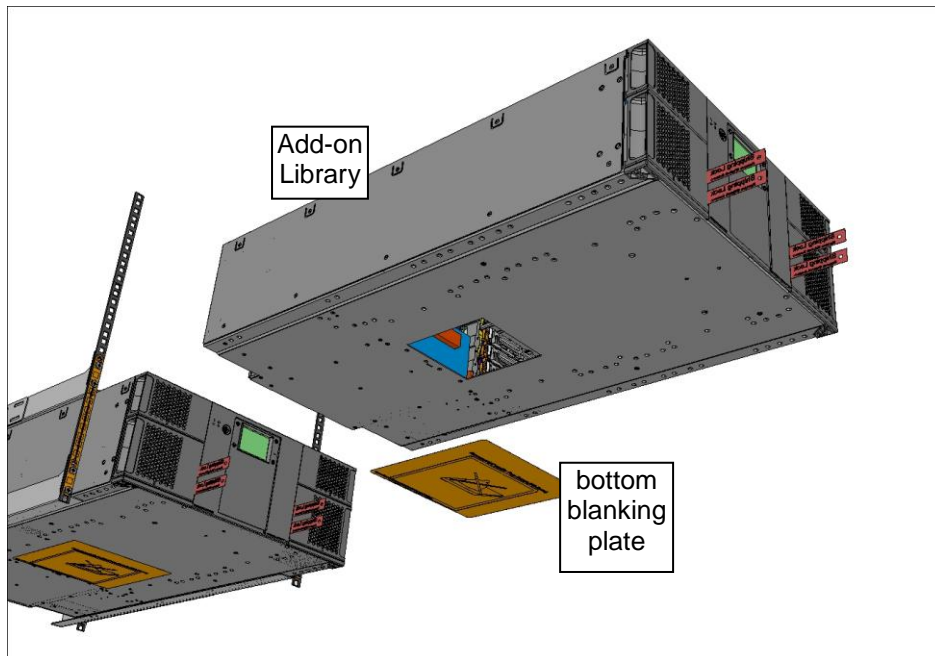

Figure 13. Remove the bottom blanking plate of the upper-most unit



Note

If the unit is in-between two other units, both top and bottom plates are removed.

Figure 14. Slide the units onto the rails, leaving ~100mm for ear mounting

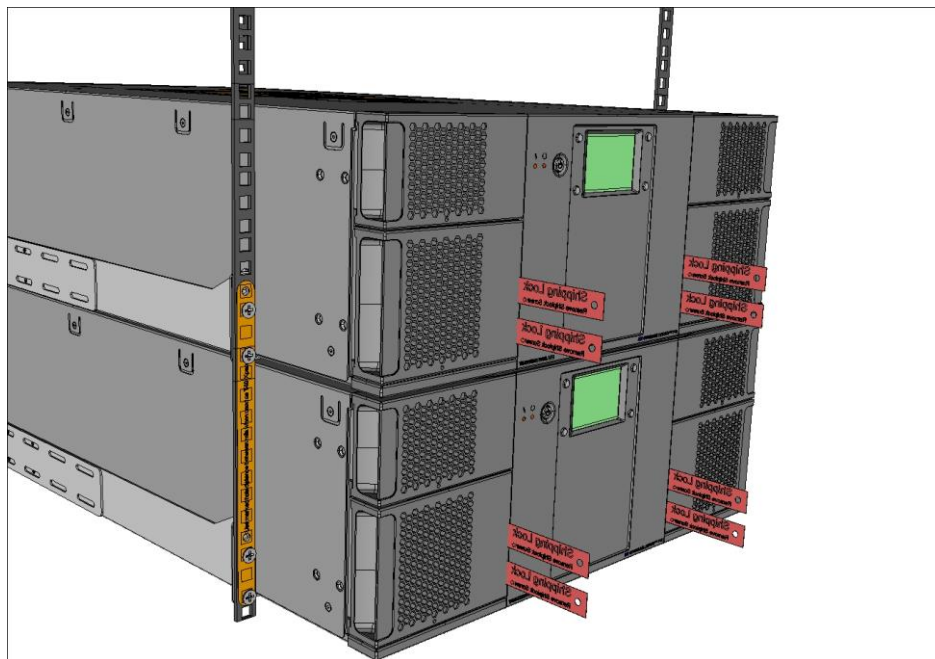
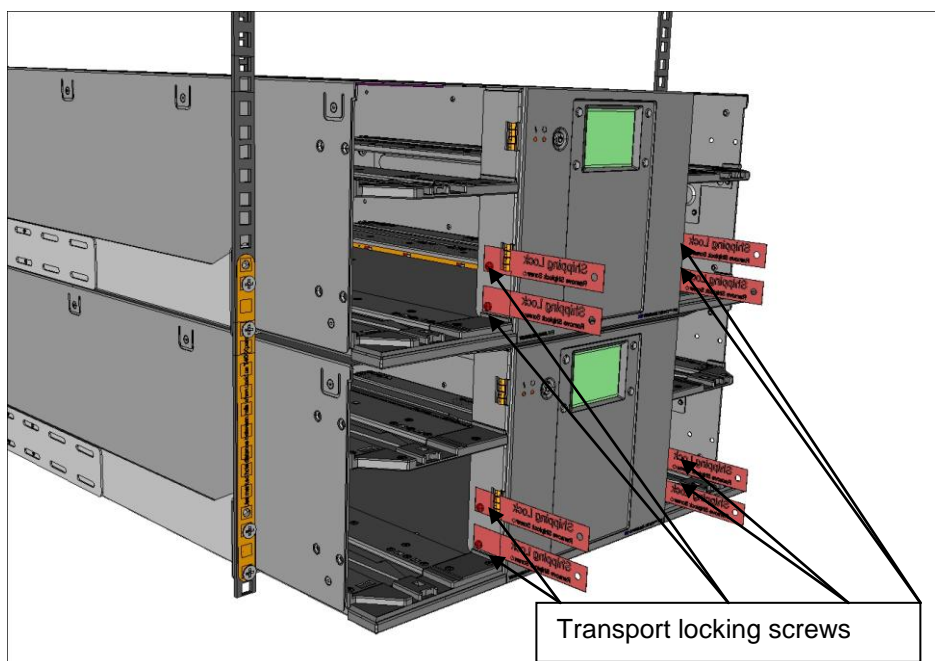

Figure 15. Remove the transport locking screws



⚠ Caution

The transport locking screws must be removed before the StorageLibrary can operate normally. Be careful not to drop any of the transport locking screws inside the unit.

Figure 16. Mount the ears on the side of the units

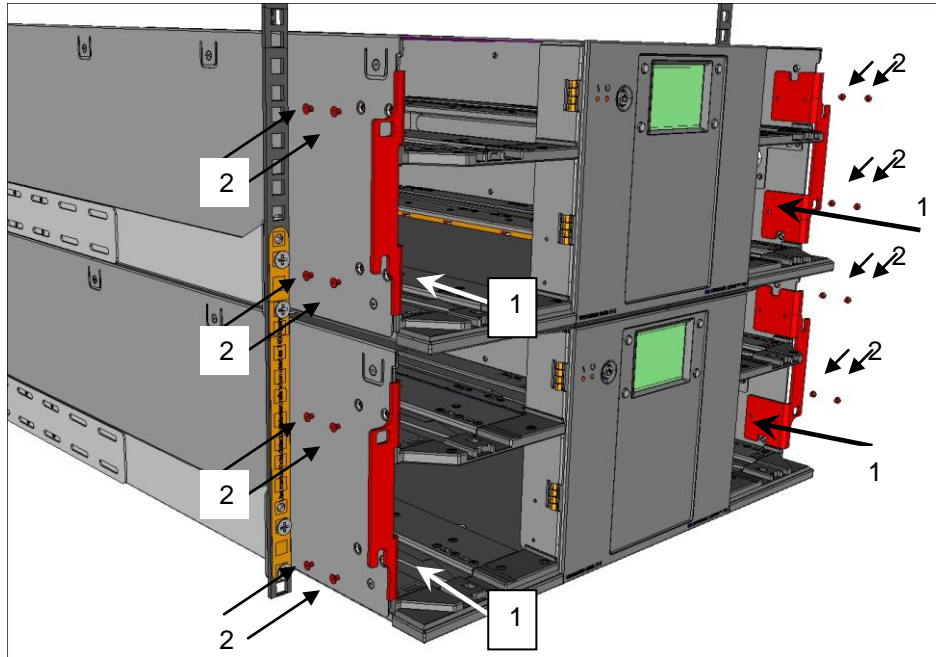

Figure 17. Ear screws mounting sequence

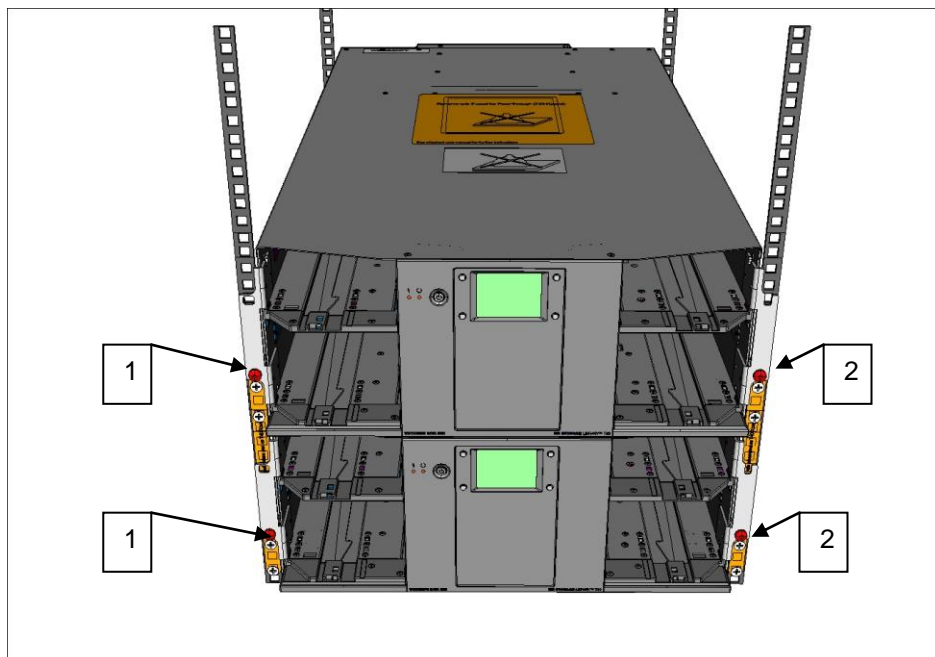

Figure 18. Install the Pass-Thru box in the Pass-Thru magazine

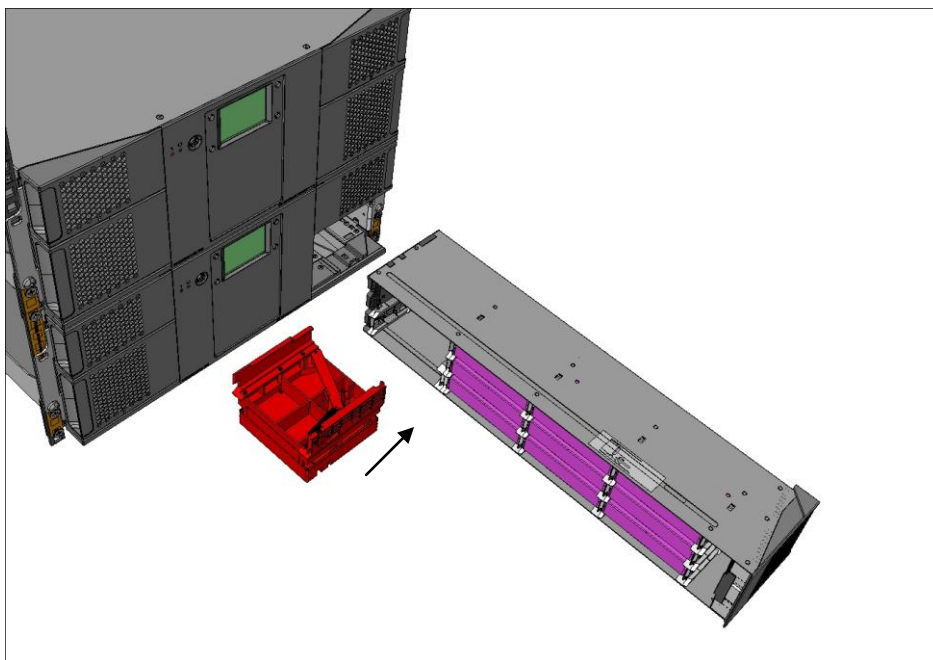

Figure 19. Exchange the right lower-most magazine with the Pass-Thru magazine in all the units except the upper most unit

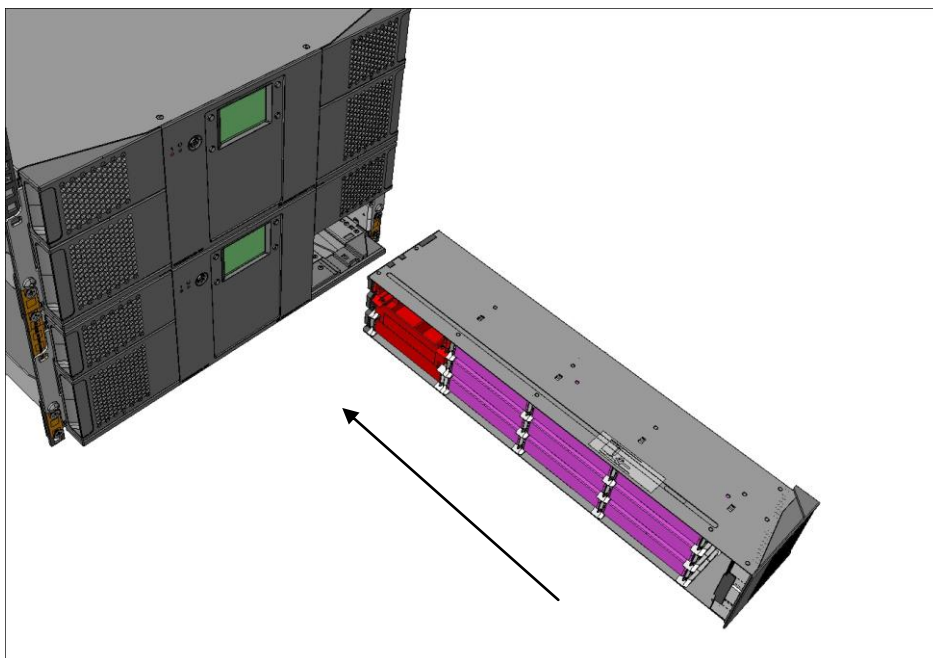
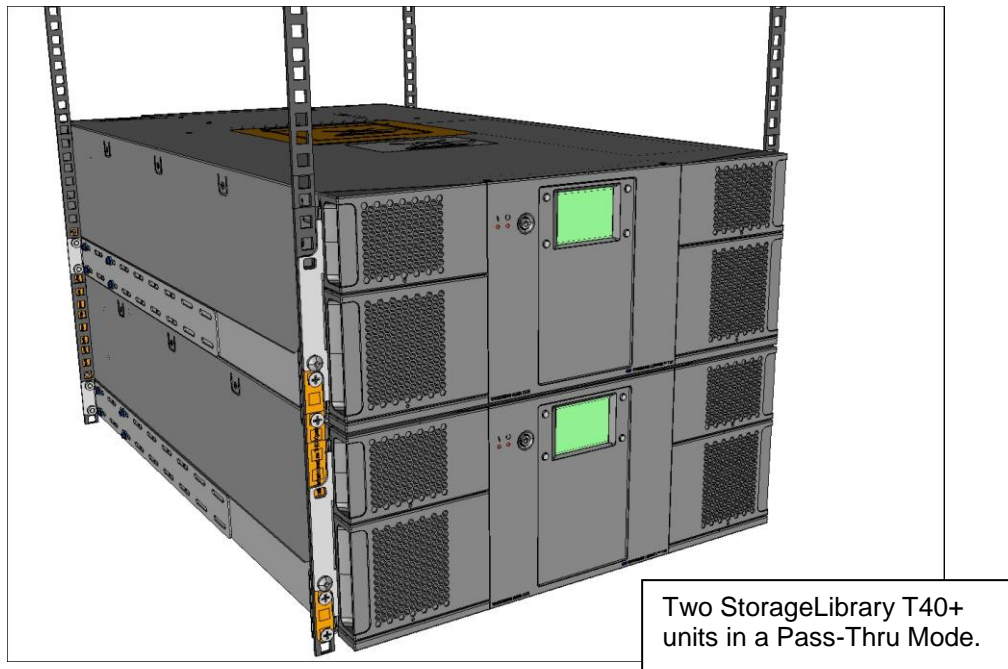

Figure 20. The Complete System



Remove the Transport Locking Screws

To protect the library during transport, four transport locking screws hold the robotics in a locked position. The screws are marked with red plastic tabs protruding between the magazines and the front panel.



Caution

The transport locking screws must be removed before the StorageLibrary can operate normally. Be careful not to drop any of the transport locking screws inside the unit.

Figure 21. Transport Locking Screws Marked with Red Plastic Tabs



The transport locking screws will be detected when the StorageLibrary is powered on. To remove the screws follow the instructions below:

1. Connect the power cord to the power connector on the back of the library.
2. Turn on the power switch on the back of the library.
3. The library detects that the transport locking screws are present. Follow the instructions on the front panel display to remove the magazines in order to get access to the screws. Remove the screws and re-insert the magazines.

The library will now continue its power-on sequence.



Note

Keep the transport locking screws in a safe place. You will need them to lock the robotics if you need to return your StorageLibrary for service or repair.



Caution

The warranty does not cover damage to the library if it is transported without the transport locking screws properly installed. See [Re-inserting the Transport Locking Screws](#) for instructions on how to re-install the transport locking screws.

Mounting the Rack mount Ears

To mount the rack mount ears, the four magazines must be removed. To remove the magazines, follow the instructions below:

1. Connect the power cord to the power connector (for power supply 1) at the back of the library.
2. Turn on the power switch (for power supply 1) at the back of the library.
3. Wait until the library completes its power-on sequence.
4. Use the front panel interface to remove the magazines (**Menu > Operations > Eject Magazine**).
5. Physically remove the magazines from the library, see [Magazine Handling](#).

If your library supports 24 magazine slots only, you need to use the emergency eject tool to remove the two upper magazines. The emergency eject tool is located at the back of the library. See [Manual/Emergency Release of Magazines](#). Mount the ears to the chassis of the library. Gently re-insert the magazines into the library.

Figure 22. Mounting the Rack Mount Ears



Installing the Library Cables

After [mounting the StorageLibrary into a rack](#), you must connect the cables to the library. Three sets of cabling instructions are available:

- For libraries with SCSI tape drives
- For libraries with SAS tape drives
- For libraries with Fibre Channel tape drives

Follow the instructions below:

Connecting SCSI Cables

Follow this procedure if you are installing a library that includes SCSI tape drives.

Figure 23. StorageLibrary Cabling (SCSI interface)

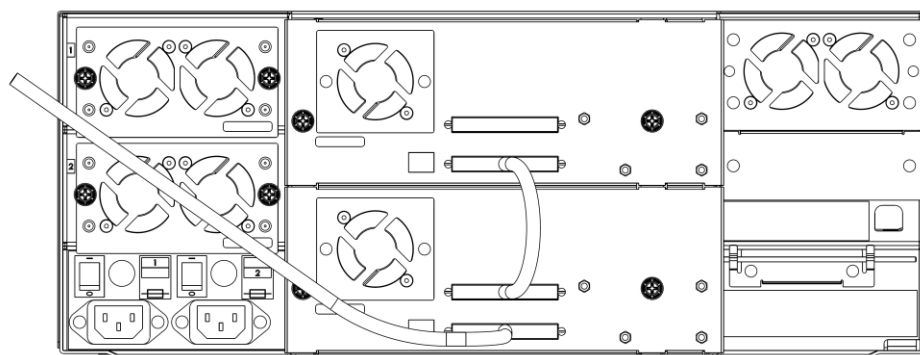

Guidelines for Connecting SCSI Cables

1. Before SCSI bus cables are connected to the StorageLibrary, make sure the StorageLibrary power switch is off.
2. Make sure your host system is in a state where a new SCSI device can be safely connected to the SCSI bus.
 - Do not exceed SCSI bus length restrictions.
 - Add the length of all external and internal SCSI cables on the bus.
 - Add 26.4 cm (10.4 inch) for the internal cable length in the StorageLibrary.
3. If the number of SCSI devices exceeds two, the maximum allowed length of an LVD SCSI bus is 12 m (39 ft).
4. Before the StorageLibrary is powered on and the system is re-started, make sure the SCSI bus is properly terminated.

Connecting the Cables

1. Connect SCSI cables to the tape drive .
 - Connect a jumper cable between the top SCSI connector of the bottom drive and the bottom SCSI connector of the drive above it. Repeat this step for all the drives on the SCSI bus. Secure the cable with the thumbscrews on the connectors.
 - Terminate the last device on the SCSI bus using the appropriate SCSI terminator.
 - Connect a cable between the first drive on the SCSI bus and the host.
2. Connect your Ethernet cable to the Ethernet port on the back of the library. This will give remote access to the library via the remote management interface. Push the cable until it snaps into place. Connect the other end to a normal 10/100 BaseT Ethernet outlet.

3. Connect a power cord to the outlet on the power supply at the back of the library.
4. Power on the library by turning on the rear power switch.
5. Power up the host system.
6. Verify communication with all devices on the bus.
7. Configure your library using the commands on the front panel. For configuration information, please refer to [Configuring the Library](#).



Warning

Make sure the AC outlet that you connect the StorageLibrary power cable into is reliably earthed.

Adding the StorageLibrary to an existing rack installation can cause a leaking current fault condition because of the summation of the leaking currents.

For safety, a 250V 2A fuse is located near the power switch.



Note

Tandberg Data recommends that all external SCSI devices, including the StorageLibrary, are powered on before the computer system is re-started (Steps 5 and 6 above).

Connecting SAS Cables

Follow this procedure if you are installing a library that includes SAS tape drives.

Figure 24. StorageLibrary Cabling (SAS interface)

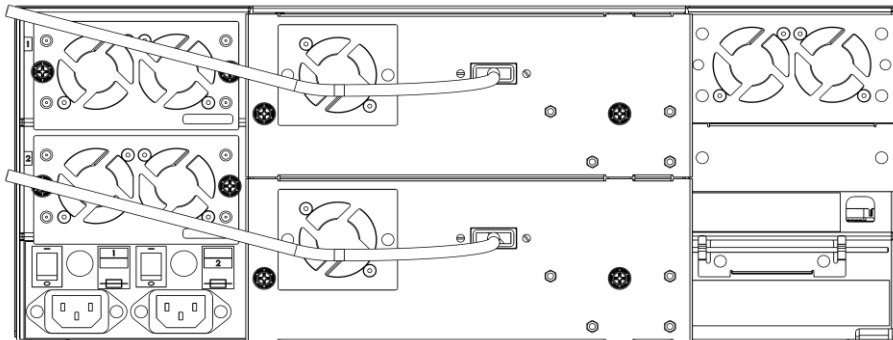

1. If your library includes tape drives with SAS interface, connect SAS cables to the tape drives. Attach one end of the SAS cable to the SAS port on each drive. Attach the other end of the cable to the host.
2. Connect your Ethernet cable to the Ethernet port on the back of the library for remote access to the library via the remote management interface. Push the cable until it snaps into place. Connect the other end to a normal 10/100 BaseT Ethernet outlet.
3. Connect a power cord to the outlet on the power supply at the back of the library.
4. Power on the library by turning on the rear power switch.
5. Power up the host system.
6. Verify communication with all devices on the bus.
7. Configure your library using the commands on the front panel. For configuration information, please refer to [Configuring the Library](#).

Connecting Fibre Channel Cables

Use this procedure if you are installing a library that includes Fibre Channel tape drives.

Figure 25. StorageLibrary Cabling (Fibre Channel interface)

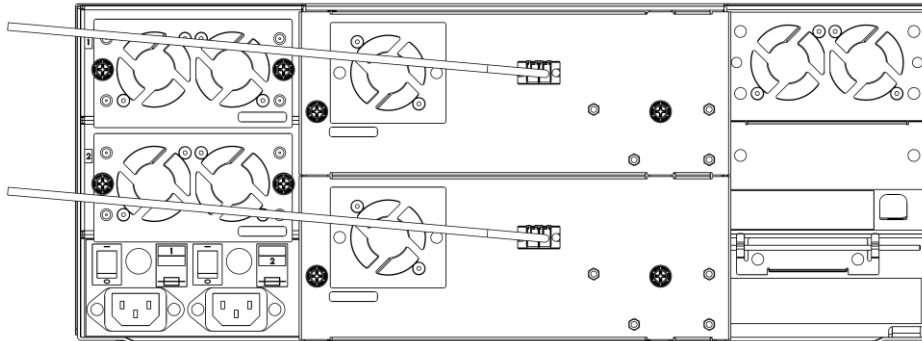

1. Connect the fibre cables to the tape drive.
2. Attach one end of the fibre cable to the fibre port on each tape drive.
3. Attach the other end of the cable to the host, switch or hub.



Note

The fibre cable can be connected from the tape drive to a switch rather than a host.

4. Connect your Ethernet cable to the Ethernet port on the back of the library for remote access to the library via the remote management interface. Push the cable until it snaps into place. Connect the other end to a normal 10/100 BaseT Ethernet outlet.
5. Connect a power cord to the outlet on the power supply at the back of the library.
6. Power on the library by turning on the rear power switch.
7. Power up the host system.
8. Verify communication with all devices on the bus.
9. Configure your library using the commands on the front panel. For configuration information, please refer to [Configuring the Library](#).

System Power-on

At power-on, for the first few seconds the unit performs a sequence of diagnostic tests called Power-On Self Tests (POST). POST also includes a loop-back test of the robotics cabling.

After the POST sequence completes successfully, the library will respond to SCSI selections. Then the system starts a series of initialization functions, a process that consists of robot calibration operations and cartridge inventory of magazines and drive. The barcode labels on the cartridges will be read when running inventory.

During these operations, the library continuously shows the map status on the screen. The status of all magazine slots and the drives are initially unknown, and a question mark (?) is displayed for each slot. As the robot searches the magazine slots for cartridges during inventory, the display is updated.



Note

You should turn on the power at least 60 seconds before the computer system is started. The tape drive needs up to 60 seconds after power-on until it is active on the SCSI bus.



Note

If the self-diagnostics and the inventory sequence are successfully completed, the green LED illuminates and the display returns to the home screen. The library is now ready for further configuration and operation.

If a problem occurs during the power-on sequence, the StorageLibrary displays an error message on the display. Please refer to [Troubleshooting](#) to learn the procedures for resolving the problem.

Labeling Cartridges for the Barcode Reader

If you want to use the barcode reader functionality in the library, you must attach barcode labels to the cartridges.



Note

You need to use StorageLibrary specific bar code labels to ensure reliable functionality of the barcode reader.



Caution

Cartridge labels must be oriented on the cartridges as shown in the Figure 26. Other orientations of the cartridge labels may interfere with the loaders operation.

Cartridge labels must be positioned on the cartridges as shown in Figure 26. The locking mechanism should be on the left. For more information, see the [Working With Cartridges and Barcodes](#) chapter.

Figure 26. Positioning of Barcode Label for LTO Cartridges



In this figure, the dotted rectangle show the correct placement for the cartridge labels.

If you need more cartridge labels, you can order more labels from your local Tandberg Data sales representative. Two types of cartridge labels are available. See Figure 27 below for part numbers.

Figure 27. Available Tandberg Data Cartridge Labels.



Label for all LTO cartridges: Part No. 870222



Labels for LTO3-cartridges: Part No. 1015514
Labels for LTO4-cartridges: Part No. 1017351

Figure 27 show the two Tandberg Data specific cartridge labels available. It also show the corresponding part numbers needed when ordering labels.

For the **cleaning cartridges**, use the labels starting with prefix CLN. In the right-most image, the prefix of this type of label is *CLNvnnLg*, where *v* identifies a drive unique cleaning cartridge, *nn* is used to track individual cleaning cartridge activity (for example usage and life), and *g* is the LTO generation.

5

Operator Interfaces

The StorageLibrary has two operator interfaces: the **Front Panel Interface (FPI)** and the **Remote Management Interface (RMI)**. Operations on the StorageLibrary can be performed locally on the library using the front panel interface, or remotely on your computer using the remote management interface. Similar functionality with common elements is used for both operator interfaces.



Note

Both the front panel and the remote management interface are required to access all options for operating the library. Some functionality is only available thru the remote management interface, and some functionality is only available thru the front panel interface. However, whenever possible it is recommended that you use the remote management interface rather than the front panel to perform library operations.

Front Panel Interface (FPI)

The front panel interface is physically attached to the front of the library. For executing basic library management functions, the operator interface appears on the LCD display of the front panel.

The functions of the four control buttons are displayed in the corners of the LCD. The functions of the buttons change during different activities, and the actual function for each button is always visible on the display.

The front panel interface includes the operator control panel with LCD display, four control buttons, two LED indicators and a standby switch.

Scroll Function

The LCD display on the front panel interface is able to display 20 characters in a line. Some functionality requires more than 20 characters. To access all characters a scroll function is implemented. The buttons on the front panel interface are used to scroll the text left or right (a left arrow appears on the left button and a right arrow appears on the right button to indicate the scroll function).

The number of lines on the display is limited. If the text to be displayed contains more than 8 lines, a similar scroll function, to that described above, is used. For line scrolling, the arrows on the buttons indicate scroll up or down function.

Remote Management Interface (RMI)

The remote management interface (RMI) is similar to the front panel interface (FPI). The remote management interface is accessible from any supported web browser. For more information on supported web browsers, please refer to [Browser Requirements](#). To manage the library from a remote management interface, you must set up the library's initial network configuration from the front panel interface. For information on network configuration settings for remote use, please refer to [Configuring Network Settings](#).

Menu Trees

The following four menus on the FPI and the RMI organize commands into logical groupings:

- The Operations menu consists of commands that enable you to change the library's mode of operations, import and export cartridges, load and unload tape drives, eject magazines, clean the drive and change partition mode.
- The Setup menu consists of commands that you can use to set up and configure various aspects of the library, including network, Pass-Thru, partitions, I/E stations, cleaning slots, drive configuration, license, password, menu timeout, date and time, barcode scan, and audible alarm.
- The Reports menu consists of summaries of the values assigned during library setup. It also includes viewing of RAS tickets and diagnostic logs.
- The Tools menu consists of commands that you can use to maintain your library such as restore default settings, restore web password, reboot, prepare for shipping, update firmware, and run system tests.

[Figure 28](#) and [Figure 29](#) give an overview of menus displayed on the [FPI](#) and the RMI.

Figure 28. Front Panel Interface (FPI) Top Level Menu Tree

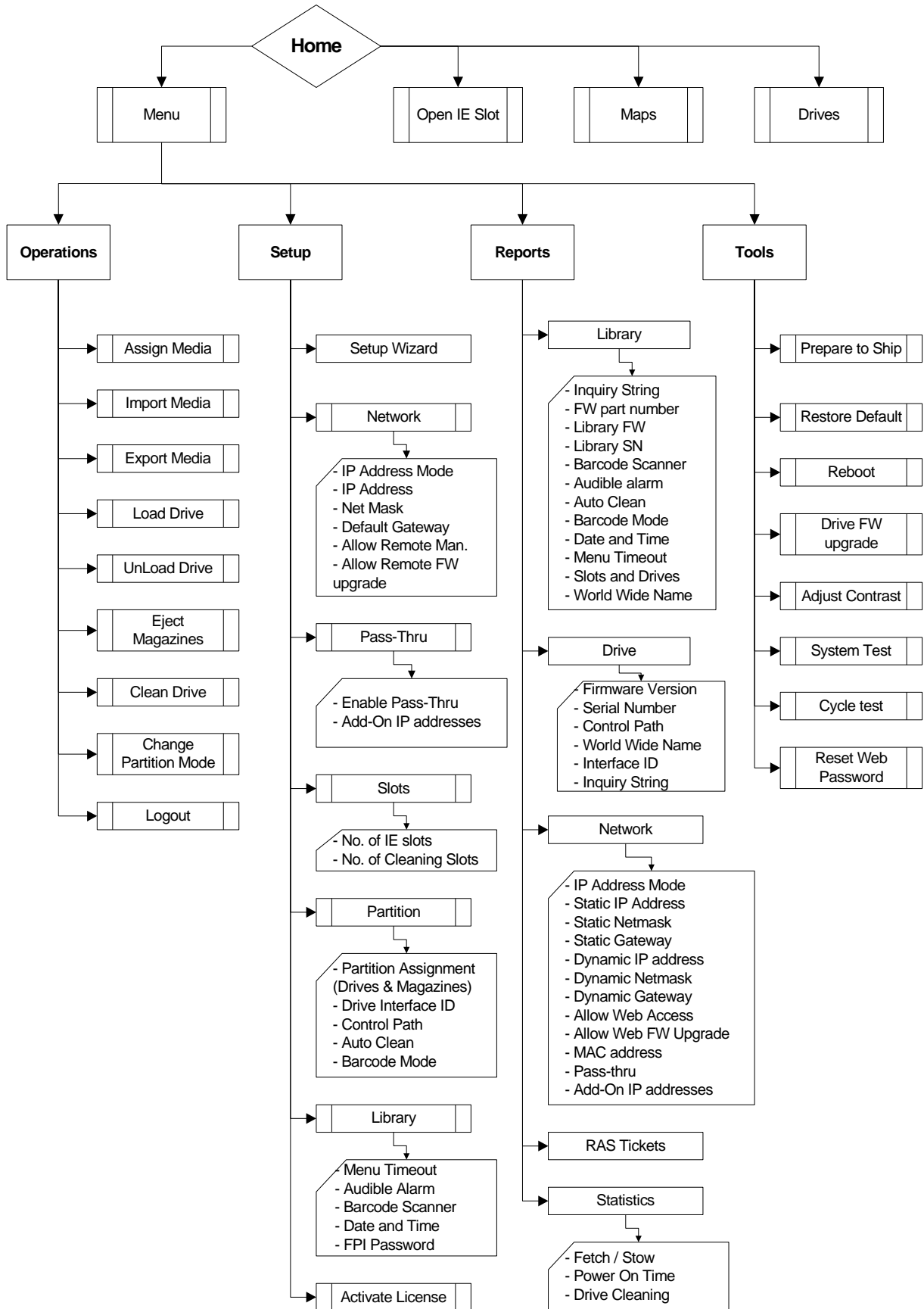
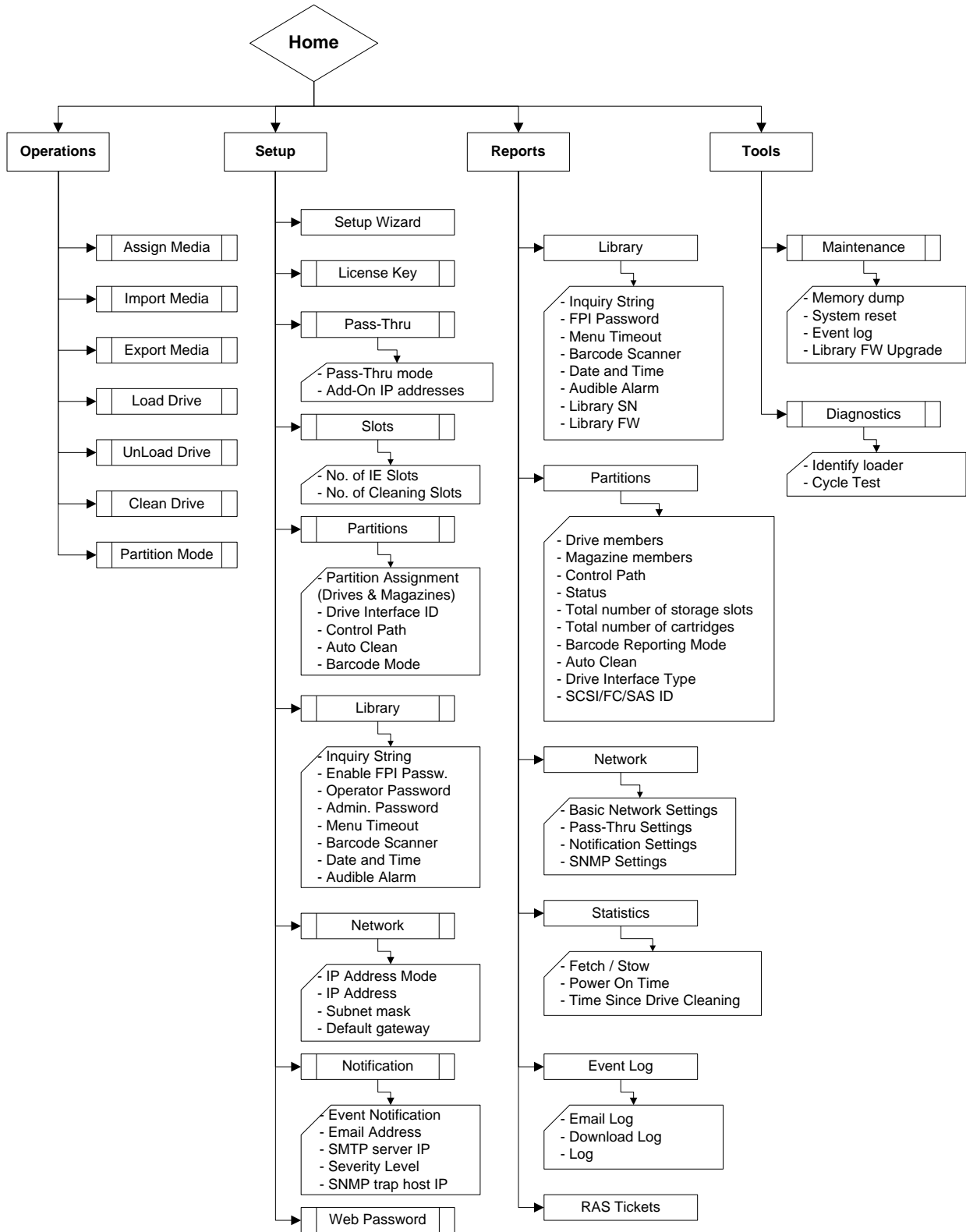

Figure 29. Remote Management Interface (RMI) Top Level Menu Tree



Home Screen

The [RMI](#) Home Screen is shown in [Figure 30](#). To navigate in the RMI menu, use the pull down menus. Click on the graphics to display status information and details about the library components.

Figure 30. Remote Management Interface Home Screen

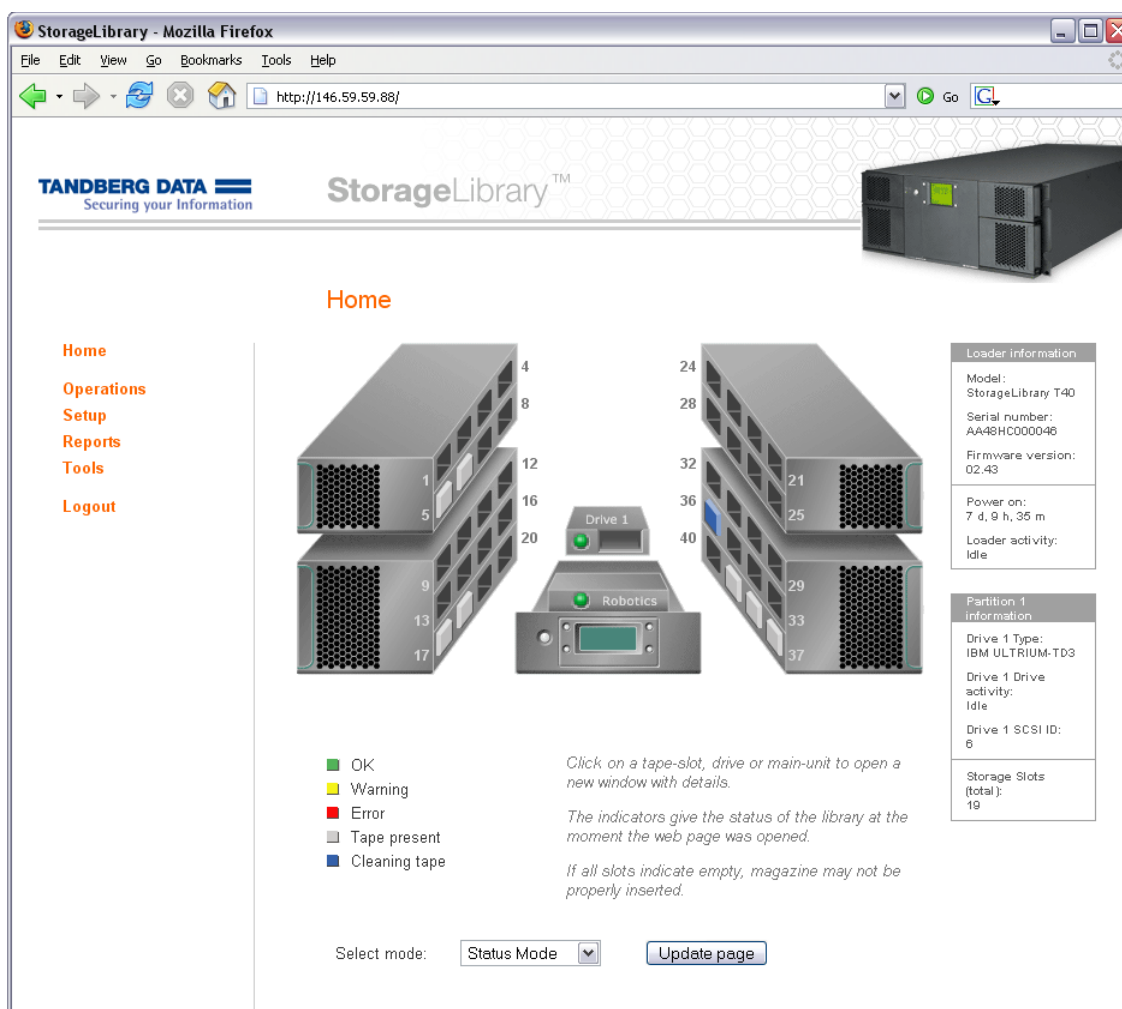

Operator Privileges

Controlling access to screens and operations within the library preserves the integrity of the library and the data that is stored within it. There are two user privilege levels within the library: Administrator and Operator.

1. Administrator is allowed access to the entire physical library and all of its partitions.
2. Operator has access to all partitions and can perform functions within partitions, such as performing cartridge and tape drive operations. An operator cannot perform operations that affect the physical library, such as creating or deleting partitions.

Details on user privileges include:

- One administrative login is available on the library. The user name is Administrator.
- One operator login is available on the library. The user name is "Operator".
- Any operator or administrative user who is logged in and inactive for more than "N" minutes is automatically logged out. "N" is user configurable, from 1 to 9 minutes.

- Selecting “Log Out” or “X” in the top right corner of the [RMI](#) closes the application and logs the user out.
- Only one user can be logged in at one time from either the [FPI](#) or the [RMI](#).

Words Commonly Used on the FPI and the RMI

Some of the words displayed on the front panel interface ([FPI](#)) and the remote management interface ([RMI](#)) screens may need an explanation. See Table 2 for commonly used words.

Table 2. Commonly Used Words on FPI and RMI

Word	Abbr. in FPI	Description
Idle		The library is idle.
Drive Empty	—	There is no cartridge in the drive.
Drive Loaded	ld	A cartridge is loaded in the drive.
Drive Idle	ie	A cartridge is loaded and the drive is ready to use it.
Drive Rewinding	rw	The drive is rewinding the tape.
Drive Seeking	sk	The drive is searching for specific data on the tape.
Drive Reading	rd	The drive is reading data for transfer to a host via the SCSI interface.
Drive Writing	wr	The drive is writing data received from a host to the tape.
Drive Erasing	er	The drive is erasing data from parts of, or the whole of, the tape.
Drive Cleaning	cl	A cleaning cartridge has been inserted into the drive, and the drive is using it to clean the relevant mechanical parts.
Drive Loading	ld	A tape has been inserted into the drive. The drive is in the process of mechanically loading the tape.
Drive Unloading	ul	The drive is in the process of mechanically unloading the tape.
Drive Update Ready	ur	The drive has completed an internal update.
Drive Updating	ud	The drive is in the process of performing an internal firmware update.
Drive Calibrating	ca	A data tape has been inserted and loaded into the drive. The drive is in the process of measuring its physical properties.

During inventory and in the Maps menu, different symbols are displayed on the [FPI](#) to indicate if there are cartridges present in the magazines, in the drives, and in the robotics. A description of the symbols are enlisted in Table 3.

Table 3. Cartridge Present Symbols on FPI during Inventory and in the Maps Menu

	Symbol on FPI	Description

Drive Status	—	Drive Present, load status empty
	??	Drive present, load status unknown
	**	Drive not installed
Magazine slot and Robotics status	■	Grey box if magazine slot/robotics status is unknown
	■	Black box if cartridge is present in the magazine slot/the robotics
	□	White box if cleaning cartridge is present in the magazine slot
	—	The magazine slot/the robotics is empty

A Maps Menu on the FPI is shown in [Figure 31](#). The figure also indicate where the Robotics Status Symbol is located on the display. An example of the library taking inventory is also shown.

- The robotics status is unknown (grey).
- Slot 30 is occupied.
- Slot 36 has a cleaning cartridge.
- Slots 29, 31 to 35, and 37 to 40, are empty.
- The status of the rest of the slots are unknown.
- One drive is installed in the lowest position, and the load status is still unknown.

Figure 31. Maps Menu on the FPI.

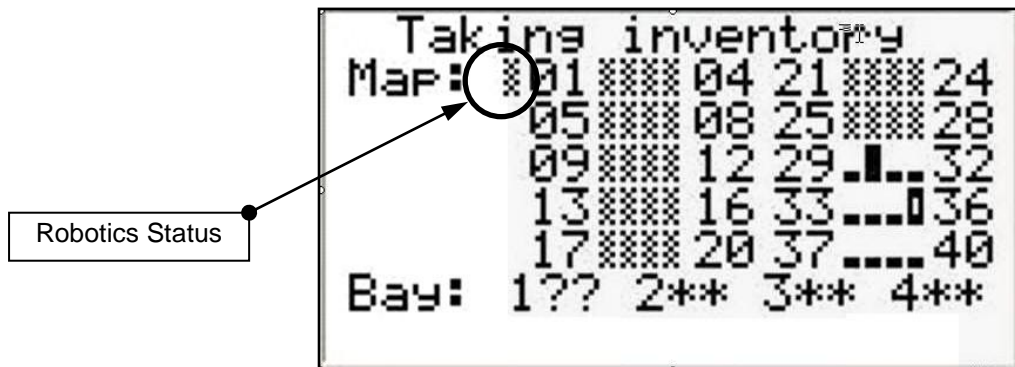

6

Configuring the Library

After you have installed the hardware described in the previous chapters, you are ready to configure your library settings. A Setup Wizard helps you get started configuring your library, and the menu commands on both the front panel interface ([FPI](#)) and the remote management interface ([RMI](#)) allow you to re-configure your library at any time.

About the Setup Wizard

When you first power on the library, the front panel interface ([FPI](#)) displays the Setup Wizard, which walks you through the initial configuration of the library's operational settings. These include network settings that enable you to access the library from the remote management interface ([RMI](#)). You must begin with the **Setup Wizard** on the front panel, although you have the option to complete the Setup Wizard on the RMI.

The Setup Wizard prompts you to enter the network settings that allow the RMI to access the library. Once this step is complete, you must choose to either complete the wizard locally (on the [FPI](#)) or remotely (on the RMI).

Configuring the library is not a one-time process. The Setup Wizard is simply an aid to assist you with the initial configuration. You can always return to the Setup Wizard, or use commands on the Setup menu, to modify all library settings, including network settings.



Note

Power cycling (powering the library on and off) is not necessary in order to configure the library.

Using the Default Administrative User Account (Administrator)

When you power on the library for the first time, it is not necessary to log in to use the front panel interface (FPI). You can start using the Setup Wizard immediately. When the library is powered ON for the first time, the password protection to the FPI is disabled. As long as there is no FPI password enabled, regardless of how many times the system is re-started, the library will have this “free access”.

Once you enable the FPI password, you will always need the password to access the FPI.

A User Name and password is always required to access the system via the Web client. It is not possible to access the library remotely without entering a password. The library ships with a default administrative user account for the RMI. When you see the Login screen on the RMI, type the **Administrator** in the User Name field, leaving the Password field blank. The user name and password are case-sensitive.



Note

You cannot delete the default Administrator account. You can, however, change the password.

Using the Setup Wizard

The Setup Wizard simplifies the process of configuring the library. When you first power on the library, the front panel interface ([FPI](#)) displays the Setup Wizard. As you work through the Setup Wizard screens, follow the on-screen instructions.

The recommended procedure for using the Setup Wizard for the initial configuration is as follows:

1. Turn on the library and go to the Setup Wizard on the FPI. Be sure to configure network settings.
 2. When the Setup Wizard screen text prompts you to choose Local or Remote, you must choose whether to complete the wizard either locally on the FPI, or remotely on the [RMI](#).
 3. If you choose to complete the wizard remotely, you must log in to the RMI. Use the default Administrator account. The **default User Name** is Administrator, and the default password field is blank.
 4. Complete the Setup Wizard.
- You may choose to use the default settings that the Setup Wizard suggests, but you must confirm the proposed settings and complete the Setup Wizard before you can begin to use the library.
 - If you choose to complete the Setup Wizard remotely, the FPI wizard automatically displays the network settings you need to access the RMI.
 - If you run the Setup Wizard from the FPI and you do not complete all the Setup Wizard screens, the library will save whatever modifications (if any) you have made. However if you run the Setup Wizard from the RMI, you need to confirm that you want to save the setup.
 - You do not need to log into the library from the FPI when the Setup Wizard appears on the front panel, the first time the library is powered on.
 - When you power-on your library for the first time, you can only configure network settings on the FPI, and you cannot log into the library from the RMI until you have configured network settings.
 - You can always return to the Setup Wizard whenever you are logged in as Administrator to either the FPI or RMI.



Note

The setup wizard may need to reboot your library one or more times during setup

Setup Wizard Tasks

The Setup Wizard contains all configuration options. When you first power on the library you must complete the Setup Wizard. When you later want to re-configure the library you can choose to either use the Setup Wizard or the individual configuration options found in the Setup menus.

This section includes an overview of the Setup Wizard configurations. The configurations are described in detail in the following chapters.



Note

You may not see all the choices presented below when running the Setup Wizard using the [FPI](#). It routes you past choices that have become irrelevant because of previous selections.

Example: If you select DHCP mode on the RMI, the Static IP address, netmask and default gateway are irrelevant.

- Welcome - Welcomes you to the Setup Wizard.

- Configuring I/E Slots ([FPI](#) and [RMI](#)) - Allows you to configure the number of Import/Export (I/E) slots.
- Configuring Cleaning Slots (FPI and RMI) - Allows you to configure the number of dedicated cleaning slots to be used through the host application.
- Configuring Partitions (FPI and RMI) - Allows you to select the number of partitions and the drives and magazines assigned to each partition.
- Modifying Control Path (FPI and RMI) - Allows you to configure which drive shall be the control path in each of the partitions.
- Configuring Auto Clean (FPI and RMI) - Allows you to enable/disable automatic drive cleaning.
- Configuring Barcode Scan (FPI and RMI) - Allows you to enable/disable the barcode reader.
- Configuring Severity Level (RMI) – Allows you to choose what errors and warnings are to be reported.
- Configuring E-mail Notification (RMI) – Allows you to enter an e-mail address to receive notification of warnings and errors.
- Configuring Network Settings (FPI) - Allows you to enter your network settings for remote access.
- Choosing the Interface (FPI): - Allows you to choose to continue locally on the front panel interface (FPI) or on the remote management interface (RMI). If you choose Local, the wizard proceeds on the FPI. If you choose Remote, the FPI presents a Refresh button that needs to be selected until the Network Setting appears. Exit the FPI, log in to the RMI using the Network Setting, and select Setup Wizard to resume configuring your library.
- Applying a License Key (FPI and RMI) - Allows you to enter a numeric code (License Key) for capacity on demand.
- Configuring Pass-Thru (FPI and RMI) – Allows you to combine two or more libraries to expand the storage capacity.
- Setting Tape Drive ID (FPI and RMI) – Allows you to configure the SCSI ID of the SCSI drives if your library includes SCSI drives. If your library includes fibre channel or SAS drives the node name and port name appear.
- Modifying Library Inquiry String (FPI and RMI) - Allows you to configure the Inquiry String for the library.
- Configuring Password (FPI and RMI) - Allows you to set password on the FPI.
- Configuring Menu Timeout (FPI and RMI) - Allows you to configure the timeout delay on the FPI and the RMI menus.
- Setting Date and Time (FPI and RMI) - Allows you to set the date and time on your library (set the real time clock).
- Configuring Audible Alarm (FPI and RMI) - Allows you to enable/disable the audible alarm.
- Confirm Settings (FPI and RMI) - Allows you to confirm your library settings.



Note

Configure the date and time of the library from the Setup menu immediately after initial configuration of the library using the Setup Wizard.

The front panel displays the Setup Wizard the first time you power on. After that, you can log in as Administrator to access the Setup Wizard. The paths used to open the appropriate screen are:

- From the RMI, select **Setup > Setup Wizard**
- From the FPI, select **Menu > Setup > Setup Wizard**

Applying a License Key

A license key can be purchased and applied to the library to increase the number of available slots from 24 to 40. The license key is applied during the initial configuration of the library, and may also be applied at any time in the future.

An instruction sheet that describes how to use the license key is provided in the accessory kit. Contact Technical Support for more information on obtaining a license key. For contact information, see [Getting More Information or Help](#).



Note

The license key is composed of a maximum of five printable characters. The license key is case-sensitive.

The license key is verified when it is applied to the library. It cannot be transferred to another library.

The license key can be entered when running the Setup Wizard. After the initial setup of your library you can later access the Activate License configuration screens directly:

- From the [RMI](#), select **Setup > License Key**
- From the [FPI](#), select **Menu > Setup > Activate License**

The library reboots after three failed activation attempts.

Configuring Pass-Thru

Pass-Thru is used to combine two or more libraries to increase the number of available slots to above the 40 available with one unit, and to allow the combined system to operate as one logical unit. The bottom-most unit in the Pass-Thru system is called Master Library, and the units above are called Add-on Libraries.

Before you start the Pass-Thru configuration, you must have a Pass-Thru kit available. A Pass-Thru kit can be purchased from your Tandberg Data distributor. Follow the instructions given in the [Hardware Installation](#) chapter to install the Pass-Thru kit.

To configure two or more T40+ units as a Pass-Thru system, start the Pass-Thru Wizard beginning with the master library. Follow the directions on-screen, and when so prompted, start the Pass-Thru Wizard on the add-on units. The Setup Wizard on the add-on units will give you the information necessary to complete the configuration of the master library.

When the Pass-Thru system has been fully configured, both units will reboot. Insert the Pass-Thru magazine after the system has rebooted.

The Pass-Thru settings are configured with the Setup Wizard. After the initial setup of your library, you can later access the Pass-Thru configuration screens directly:

- From the [RMI](#), select **Setup > Pass-Thru**
- From the [FPI](#), select **Menu > Setup > Pass-Thru**

Configuring I/E Slots

I/E slots are used to import and export tape cartridges into and out of the library without disrupting normal library operations.

The 24-slot version of the T40+ can be configured to have 0 or 3 I/E slots, and the 40-slot version or Pass-Thru system can be configured to have 0, 3, or 8 I/E slots. A library configured with 3 I/E slots will have the I/E slots located in the front of the lower left magazine. In a library configured with 8 I/E slots, the entire upper left magazine will be used as an I/E station.



Caution

Configuring I/E slots with cartridges already loaded compromises data security. First remove cartridges from the I/E slots, and then configure the I/E slots.

I/E slots are shared by all partitions within a library.

Before you change the number of I/E slots, it is recommended that you remove any cartridges from the slots that will become the new I/E slots. If the new I/E setting specifies 3 I/E slots, the number of slots in the partition owning the lower left magazine will be decreased by 3. If the new I/E setting specifies 8 I/E slots, the partition owning the upper left magazine will lose all 8 slots in this magazine. Any cartridges left in the new I/E slots will become unassigned.

When changing the number of I/E slots from 3 to 0 or 8, the 3 front slots in the lower left magazine will automatically be assigned to the same partition as the rest of the slots in this magazine.

When changing the number of I/E slots from 8 to 0 or 3, the entire upper left magazine will automatically be assigned to one of the existing partitions, as determined by the original partition configuration.

When the I/E setup is changed, it is highly recommended that the partition setup also be changed accordingly.

To identify how the I/E magazine is configured, view the Partitions report available from the Reports menu.

The I/E slots are configured while running the Setup Wizard. After the initial setup of your library, you can later access the I/E Station configuration screens directly:

- From the [RMI](#), select **Setup > Slots**
- From the [FPI](#), select **Menu > Setup > Slots**

Configuring Cleaning Slots

The Cleaning Slot configuration screen provides information on configuring dedicated cleaning slots, which are used to store cleaning cartridges that the library uses to clean tape drives. These dedicated cleaning slots are not visible to the host application.

The Setup Wizard Cleaning Slot Configuration screen prompts you to enter the number of cleaning slots you want to designate for your library. You can also access the Cleaning Slot Configuration screens directly from either the front panel or the remote management interface.

Configuring one or more dedicated cleaning slots is required to enable the library's cleaning feature. The library supports 0-3 cleaning slots. These are located as the three innermost slots (innermost column) of the lower right magazine. If the unit has a Pass-Thru magazine, the cleaning slots are located at the innermost slots next to the Pass-Thru box slot (see [Figure 18](#)).

If the library has been previously configured, the number of cleaning slots that are currently configured appears on the screen. The cleaning slots are shared by all partitions within a library. Each partition can use a cleaning slot to manually clean its tape drive(s).



Note

If cleaning is managed by the host application, you should set the number of cleaning slots to zero.



Caution

Make sure the library has empty slots available in the cleaning slot magazine before you add more cleaning slots. These are located as the three innermost slots (innermost column) of the lower right magazine. If the unit has a Pass-Thru magazine, the cleaning slots are located at the innermost slots next to the Pass-Thru box slot (see [Figure 18](#)).

When the number of cleaning slots is increased, the added slots are taken from the partition owning the lower right magazine. The number of available slots in the affected partition is decreased by the same number.

When the number of cleaning slots is decreased, the released slots are added to the partition owning the lower right magazine. Make sure you remove the cleaning cartridges from the library before you reduce the number of cleaning slots.

The cleaning slots are configured with the Setup Wizard. After the initial setup of your library you can later access the cleaning slot configuration screens directly:

- From the [RMI](#), select **Setup > Slots > No. of Cleaning Slots**
- From the [FPI](#), select **Menu > Setup > Slots > No. of Cleaning Slots**

Configuring Auto Clean

The library supports automatic cleaning of the drives. After a successful move medium command, but before responding with status to the host, the system requests status from the drive to determine if the drive requires cleaning. If Auto Clean is enabled and a usable cleaning cartridge of the correct media type is available, a cleaning operation will be initiated. The library selects a cleaning cartridge, mounts it into the drive and waits for the drive to complete the cleaning operation. The drive automatically unloads the cleaning cartridge. The library returns it to its original location, and then returns the completion status to the host.

The Auto Clean is configured with the Setup Wizard. After the initial setup of your library you can later access the Auto Clean configuration screens directly:

- From the [RMI](#), select **Setup > Partitions**
- From the [FPI](#), select **Menu > Setup > Partition**

Configuring Partitions

Partitions are virtual sections within a library that present the appearance of multiple, separate libraries for purposes of file management, access by multiple users, or dedication to one or more host applications. By default, the library has one partition, which includes all of the library's resources.

Administrator can create and delete all partitions. The partitions are generated manually one at a time. You can create partitions on either the front panel or the remote management interface. Operator has access to all partitions but cannot create or delete partitions.

As a minimum, a partition consists of one tape drive and one magazine. The tape drive or slot cannot be shared with another partition (exceptions to the sharing restrictions are cleaning cartridges and the I/E station slots, which are shared among all partitions).

You can later change your partition setup either from the front panel or the remote management interface.

Partitions are not supported for pass-thru systems. (T80 / T120 / T160)



Note

During configuration, you can select which drives and magazines that are to be visible to the backup software. By removing some drives or magazines, you can comply to your backup software's licencing requirements. To let the library operate at full capacity, leave all drives and magazines activated.

Creating Partitions

Use the front panel or remote management interface to create partitions. The maximum number of partitions that can be created depends on how many drives are installed (up to 4). The Administrator must define at least one partition.

To define Partition 1, the user will be asked to select the drives that are to be associated with the partition.

The user will also be asked to select which available magazines are to be included in the partition. Depending on the selections for I/E and cleaning slots, the number of slots for some magazines may be affected.

Based on the input for I/E and cleaning, the wizard displays the number of slots associated with each magazine so that the information is visible to the operator.

For each partition, the user is asked to verify, or change, the SCSI ID and Control Path, to specify whether he wants Auto Clean enabled or disabled, and to specify the Barcode Reporting mode (6 characters or 13 characters).

If there is at least one unassigned drive and one unassigned magazine, the wizard asks if the user wants to configure another partition. If yes, then repeat the steps for partition setup. If no, the user receives a warning that there are unassigned resources in the library.

The partitions are configured with the Setup Wizard. If you later want to change your partition configuration, you can either re-run the Setup Wizard or access the partition configuration screens directly:

- From the [RMI](#), select **Setup > Partitions**
- From the [FPI](#), select **Menu > Setup > Partition**

Re-configuring Partitions

You may later need to re-configure your partition setup if the number of cleaning slots or the I/E slot configuration are changed, or if you need to split the library into a larger og smaller number of partitions.



Note

Exporting all cartridges already assigned to the partitions is recommended before you reconfigure your partition.

It is not possible to edit your partition setup. If you choose to re-configure your partition setup from the front panel interface, the old setup will be deleted.

If you choose to re-configure your partition setup from the remote management interface and your current partition configuration has used all available resources, you will need to remove at least one partition. The resources from the deleted partition(s) can then be allocated to the remaining partition(s).

The appropriate screens to re-configure your partition setup are:

- From the [RMI](#), select **Setup > Partitions**
Use the “next” button in the setup to move to the last partition. Use the “remove partition” button to remove the partition. Remove as many partitions as you want to, and then allocate the drives/magazines from the deleted partitions to the remaining or new partitions.
- From the [FPI](#), select **Menu > Setup > Partition**

Changing Partition Modes

The library has two partition modes, Online and Offline.



Note

When changing the partition mode from online to offline, all host application commands are completed if they are in progress when the mode is changed.

- Online — the normal operating condition for the partition. In this mode, the robotics is enabled and all host application commands are processed.
- Offline — the partition does not process any host application commands. If a partition is taken offline, the physical library and other partitions are not affected.

The library is automatically taken offline when the unit is busy executing internal time consuming tasks.

In addition, the user can manually take the physical library, or any of its partitions, online or offline. You can take a partition offline rather than the entire library so as to minimize disruption of library operations. You may manually change the partition mode to online or offline from the front panel or from the remote management interface.

Details on changing partition mode include:

- The default partition mode is online.
- The partition mode must be set to Offline if you want to restrict host access to the specified partition.

When you are changing partition mode, be aware of the following information:

- The Online/Offline buttons toggle between states.
- It is only possible to set a partition offline when the partition is not in use.
- Set the button to read Online to take either the physical library or a partition (depending on the current view) to an online state. This is the normal operating condition. In this mode, robotics is enabled and all host commands are processed.
- Set the button to read Offline to take either the physical library or a partition (depending on the current view) to an offline state. If only the physical library is taken offline, the library's partitions will not process robotics commands, even though they are online. If only a partition is taken offline, neither the physical library nor the other partitions will be affected

The paths to open the appropriate screens are:

- From the [RMI](#), select **Operations > Partition Mode**
- From the [FPI](#), select **Menu > Operations > Change Partition Mode**

Setting Drive ID

A SCSI ID is a value between 0–15. Each device on a SCSI bus (including the HBA) needs to have a unique ID. Changing the SCSI ID is necessary when there is a duplicate ID on a single bus. Typically, the HBA SCSI ID is set to 7. For example, if two tape drives are connected together on the same bus, each tape drive must have different SCSI IDs and they must be different from the HBA SCSI ID.

The library assigns default SCSI IDs to SCSI tape drives. The SCSI ID for drives is based on the bay position in the library, and not the drive itself. This means that if a drive is replaced, or moved to a different bay, the drive will take on the SCSI ID of the bay that it is installed in. The Set Drive ID feature allows the operator to change the SCSI ID for any drive position. The default SCSI ID for the drive bays is defined as follows:

Drive Bay	Default SCSI ID
1 (bottom)	0
2	1
3	2
4 (top)	3

The drive SCSI ID is configured with the Setup Wizard. After the initial setup of your library you can later access the SCSI ID configuration screens directly:

- From the [RMI](#), select **Setup > Partitions**
- From the [FPI](#), select **Menu > Setup > Partition**

If your library includes fibre channel or SAS tape drives, the Setup Drive ID screen shows the world-wide node name and port name of the drive. These are not configurable.

The world-wide node name and port name for drives is based on the bay position in the library, and not the drive itself. This means that if a drive is replaced, or moved to a different bay, the drive will take on the node name and port name of the bay that it is installed in.

The node names and port names are unique for each library and are assigned to the library during manufacturing.

Modifying the Control Path

The control path tape drive is used to connect a partition to a host application. For normal operation, only one tape drive should be selected as the control path for each partition at any one time. By default, the lowest tape drive assigned to a partition is designated the control path. In the event that the control path connection to the host application fails, you may manually select a new control path for the partition.



Note

You may need to modify settings in your host application as a result of modifying the control path. For details, please refer to your host application documentation.

The control path is configured with the Setup Wizard. After the initial setup of your library you can later access the control path configuration screens directly:

- From the [RMI](#), select **Setup > Partitions**

Configuring Menu Timeout

The Menu Timeout feature allows you to configure the timeout delay on the front panel and remote management interface. If there has been no activity on the front panel or remote management interface for a specified time, the FPI and RMI screens return to the home screens. The menu timeout is user settable from 1 to 9 minutes. The default value is 1 minute.

The menu timeout is configured with the Setup Wizard. After the initial setup of your library you can later access the Menu Timeout configuration screens directly:

- From the [RMI](#), select **Setup > Library**
- From the [FPI](#), select **Menu > Setup > Library**

Setting Date and Time

The library is equipped with a battery backed up real time clock. The time is set initially during manufacturing, but needs to be re-set to the local time by the user. As a minimum, it is recommended that the library's date and time be set during initial configuration. The settings are used to log the date and time that events have taken place. The library date and time settings can be modified at any time.

The time is set to a 24 hour clock. For example, four o'clock in the afternoon is entered as 16:00.

The Date & Time is configured with the Setup Wizard. After the initial setup of your library you can later access the Date & Time configuration screens directly:

- From the [RMI](#), select **Setup > Library**
- From the [FPI](#), select **Menu > Setup > Library**

Configuring Barcode Scan

This feature allows the operator to enable or disable the barcode scanner from the front panel or the remote management interface. The default setting for the library is “barcode scanner enabled”. If disabled, the library will locate cartridges using the robotics.

The Barcode Scan is configured with the Setup Wizard. After the initial setup of your library you can later access the Barcode Scan configuration screens directly:

- From the [RMI](#), select **Setup > Library**
- From the [FPI](#), select **Menu > Setup > Library**

Configuring Audible Alarm

The library is equipped with an audible alarm that is activated upon certain error conditions. The alarm can either be enabled/disabled from the front panel or from the remote management interface. The default for the library is audible alarm disabled.

The Audible Alarm is configured with the Setup Wizard. After the initial setup of your library you can later access the Audible Alarm configuration screens directly:

- From the RMI, select **Setup > Library**
- From the FPI, select **Menu > Setup > Library**

Configuring Network Settings

The Network configuration screen provides information on the network settings that are configurable from the front panel. The network settings include:

- Dynamic or static IP address
- Static IP address
- Static default gateway
- Static subnet mask
- Enable/disable RMI interface
- Enable/disable RMI FW upgrade

Use the Network configuration screen to configure the library network settings. The network settings set the connectivity of the library to the network.

If Dynamic Host Configuration Protocol (DHCP) is enabled on your network, enabling DHCP will automatically configure the library network settings. If DHCP is not enabled on your network, you need to manually configure the IP address, subnet mask, and default gateway settings.

Details on network settings include:

- The library can be set to DHCP mode. In this mode the IP address, subnet mask, and default gateway is configured by a DHCP server. DHCP is selected by default. If DHCP mode is not selected, IP address, subnet mask, and default gateway must be entered.
- The IP Address, Subnet Mask, and Default Gateway text boxes are limited to numeric characters. Each of the four groups cannot have a value greater than 255.

The paths to open the appropriate screens are:

- From the RMI select **Setup > Network**

After the initial setup of your library you can access the Network configuration screens directly from both the FPI and the RMI:

- From the [RMI](#), select **Setup > Network**
- From the [FPI](#), select **Menu > Setup > Network**

Remote Access

If you choose to complete the Setup Wizard remotely, the wizard on the front panel interface ([FPI](#)) automatically displays the Network settings you need in order to access the remote management interface ([RMI](#)).

The network settings are also viewable from the front panel **Menu > Reports > Network** screen. The screen provides the information necessary to access the remote management interface.

The screen lists the IP address of the library. Use this IP address to access the remote management interface using a web browser. When typing the IP address into a web browser, make sure you precede it with “http://” (for example, http://123.123.123.123).

The legal values are enable and disable.

Configuring FPI Password

There are two user access levels in the library: Operator and Administrator. The FPI has two levels of password corresponding to the two access levels.

The Operator has access to all of the features in the Reports and Operations sub-menus. These features allow the Operator to check statistics and issue basic tape management functions. The Operator does not have access to any features that change settings in the library or run diagnostics. The Administrator has access to all features.

If a password is enabled, it is enabled for both the Operator and the Administrator. If the password is disabled, it is disabled for both the Operator and the Administrator. Enabling the password prompts the operator to set passwords for both the Operator and Administrator. The default for the library is password disabled.

The FPI Operator and Administrator passwords are configured from the FPI or RMI.

The FPI password is limited to a maximum of 4 numeric characters. The password text is masked when being entered through the FPI.

If the FPI passwords are enabled, the FPI interface requires that the Administrator password is entered before it allows access to the Change Passwords dialog.



Caution

If you set a password, make sure you do not forget it. If you do, it can only be reset with assistance from Tandberg technical support. For contact information, please refer to [Getting More Information or Help](#).

The FPI password is configured with the Setup Wizard. After the initial setup of your library you can later access the FPI Password configuration screens directly:

- From the RMI, select **Setup > Library**
- From the FPI, select **Menu > Setup > Library**

Configuring RMI Password

When you log into the RMI, a specific level of security is always assigned. It is not possible to access the library remotely without entering a password. Use the default administrator account if you want to log in as administrator and the default operator account if you want to log in as operator. The default administrator user name is “Administrator” and its default password field is blank. The default operator user name is “Operator” and its default password field is blank.

The remote Administrator has access to all features in the library. The remote operator has access to the same features as the local operator. The remote Administrator is the only one to set the remote passwords for both the Administrator and Operator. All remote Operators log in using the same password. All remote Administrators log in using the same password.

Note that when setting the remote password, the password is transmitted in plain text over the network. On subsequent use, however, password encryption is used.

The path to open the appropriate screen is:

- From the [RMI](#), select **Setup > Web Password**

Configuring SNMP

The library supports system monitoring via SNMP (Simple Network Management Protocol) and SNMP notifications. To enable SNMP, the remote management interface must be running. To enable SNMP notifications, you need to register the IP address of the notification recipient (host).

The library ignores all SNMP SET operations, so external management applications cannot register themselves to receive SNMP traps from the library. The SNMP notification screen lets you manually register an external application.

SNMP notification can only be set up by the Administrator from the remote management interface. The screen lists the existing IP address. The Port number is fixed to 162 UDP.

The user needs to register the IP address of the notification recipient in the empty IP address field displayed on the screen.

If you want to disable SNMP notifications enter 0.0.0.0 in the IP address field. Note that this disables notification only. The library will continue to process SNMP Get requests as long as the RMI is enabled.



Note

You need to install the appropriate MIB for your FW version on the host on which the SNMP manager is running.

The path to open the appropriate screen is:

- From the RMI, select **Setup > Notification**

Configuring Notifications

The library can be configured to automatically notify whenever an issue of a particular severity level occurs with one of its components. The notification can be received on the [FPI](#), [RMI](#) or by e-mail.

The notification received by e-mail provides a so called RAS ticket, a short problem description, and a possible cause which may be of help either to you or a customer service engineer. For more information about RAS tickets, please refer to [About RAS Tickets](#).

Severity Level

The library can be configured to filter out RAS tickets according to a Severity Level Threshold. There are three levels available:

- **Low** – An error has occurred in the library, but the library is not in danger of failing. (This setting enables all RAS tickets.)
- **High** - The library is not in immediate danger of failing, but current problems could lead to a failure in the future. (This setting enables RAS tickets with priority 1 and 2 only.)

- **Urgent** - The library has failed or is in immediate danger of failing. A resolution must be found immediately. (This setting enables RAS tickets with priority 1 only.)

Configuring E-mail Notification

Before you can configure e-mail notifications, you must configure the library's e-mail account so that the library can send notifications to the designated recipient. E-mail notification can only be configured from the [RMI](#).

You need to complete the following steps to configure e-mail Event Notification:

1. Enable or disable the e-mail notification feature, as appropriate.
2. Enter the recipient's e-mail address to be used for event notification. This will be used in the "To:"-field of e-mail sent by the library.
3. Enter the IP address of the SMTP server (Simple Mail Transport Protocol) the library should use. This should be an SMTP server that will handle or relay e-mails destined for the domain specified in the event notification e-mail address. This can be found by looking up the MX record of the domain in question in DNS.
4. Set Severity Level. Event notification e-mails will not be generated for errors of a severity below the one chosen.

The screen also provides a method to verify that the chosen settings are valid, by generating a test notification.

The path to open the appropriate screen is:

- From the [RMI](#), select **Setup > Notification**

7

Running the Library

This chapter explains how to access and operate your library. Most of the library functions described here can be found under the Operations menu.

Logging In

To access the remote management interface, the Operator and Administrator must first log in to the library, in order to perform library functions or view library operations.

If you are logging in to the library for the first time using the default Administrator account (Administrator), leave the password field blank. As soon as you have logged on, it is recommended that you change the default Administrator password.

The password protection on the front panel interface is disabled when you power ON the library for the first time. This means that anyone has full access to the library, and can do anything without being asked for a password. As long as there is no [FPI](#) password enabled, regardless of how many times the system is re-started, the library will have this “free access”.

Once the FPI password is enabled, the user will need to enter an Operator password or an Administrator password. Access to the library is now limited at two levels. When a user tries to access the library now, an “Enter Password” prompt appears on the screen.

Logging Out

Log out functionality is available on both the front panel and the remote management interface. Log out when you have finished accessing the library. Logging out secures the library from being accessed by unauthorized users.

From the remote management interface, select the LOGOUT button at the top of the screen to log out, or select X in the top right corner of the screen to close the browser window and log both the Operator and Administrator out.

From the front panel interface, select Logout from the Operations menu to log out from the library.

Importing Cartridges

StorageLibrary provides two methods for importing cartridges: via the I/E slot or via bulk loading of magazines.

Importing Cartridges via I/E Slot



Note

You can import cartridges using either the library interface or the host server software application. The instructions included below focus on the library interface method for importing cartridges. Please refer to your host application documentation if you wish to use the host to import cartridges.

1. Insert cartridges into the I/E station using the **Open IE Slot** command on the Front Panel Interface ([FPI](#)). Once the library has performed an inventory of the I/E slots, the user is prompted to assign the inserted cartridges to a partition. This assignment can either be performed directly, or postponed until later.

Do not insert cartridges into the I/E station during the library power cycle.



Note

There is no hard stop on the import slot. Stop pulling the magazine at the stop line indicated on the mail slot label on the top of the magazine. See section [Magazine Handling](#) in this chapter for more information.

2. Assign the cartridges to a partition via the **Menu > Operation > Assign Media** command.

After cartridges are loaded into the I/E station, the I/E station magazine is closed and an inventory of the I/E station is performed. A prompt appears on the display asking if you want to assign the cartridges to a partition. To begin using cartridges for data storage, cartridges must be assigned to a partition. After having selected which partition to assign the unassigned I/E cartridges to, the cartridges are ready for use.

If you select the wrong partition, open the I/E magazine, move the cartridge to a different I/E slot and close the I/E magazine. The library re-scans the I/E slots and the **Assign Media** screen appears again.

3. Use the **Import Media** command to physically move the cartridge from the I/E slot to a free storage slot in the partition where it is assigned.

If the library contains multiple partitions, the import operation will not affect operations in other partitions. Commands received through the control path of the different partitions will be queued and executed when the Import operation has been completed.

To import media, you need to provide the following information in the Operator interface:

- Partition lists the partitions that you are assigned access to view.
- Cartridges listed include the cartridges that you want to move.



Note

Moving cartridges may necessitate updating your host application. Please refer to your host application documentation.

The **Open I/E Slot** command can be accessed from FPI only.

The **Assign Media** and **Import Media** commands can be accessed from both FPI and RMI.

The paths to open the appropriate screens are:

- From the [RMI](#), select
 - **Operations > Assign Media**
 - **Operations > Import Media**
- From the [FPI](#), select
 - **Open IE Slot**
 - **Menu > Operations > Assign Media**
 - **Menu > Operations > Import Media**

Import Cartridges via Bulk Loading of Magazines

Another way to import cartridges is through bulk loading. Eject the magazines and manually insert, directly into storage slots, as many cartridges as you plan to use. Once the magazines are inserted and the inventory completed, the library configuration can be viewed from the remote management home screen or from the “**s1ots**” button on the front panel interface ([FPI](#)) home screen.

Cartridges bulk loaded this way will automatically be assigned to the partition owning the magazine.

If the magazine contains cleaning slots, cartridges installed in these slots are assumed to be cleaning cartridges and are not accessible by the partition.

If the magazine contains I/E slots, cartridges installed in these slots will be unassigned. Use the appropriate functions in the [RMI](#) or the [FPI](#) to assign these cartridges to a partition.



Caution

Cartridges must be placed in their appropriately configured slot location. e.g. cleaning cartridges should not be placed in slots configured for storage.

After your library begins operating, you may use the Import Media screen to add cartridges without interrupting library operations. Place the cartridges in an available I/E slot. The library's scanner will automatically read the barcode on new cartridges.

Exporting Cartridges

When you export cartridges from a library with logical libraries, cartridges are exported to the library's I/E slots. You can only export cartridges if there are empty I/E slots. The **Export Media** command enables you to export one or more cartridges from a partition to the I/E slots.

To export cartridges you need to provide information on which tape cartridges you want to export.



Note

Moving cartridges may necessitate updating your host application. Please refer to your host application documentation.

The paths to open the appropriate screen are:

- From the RMI, select **Operations > Export Media**
- From the FPI, select **Menu > Operations > Export Media**

Loading to Tape Drives

The Load Drive operation enables you to load cartridges from a storage slot to a tape drive, as long as they are in the same partition. The library/partition is taken offline during the load operation.

The paths to open the appropriate screens are:

- From the RMI, select **Operations > Load Drive**
- From the FPI, select **Menu > Operations > Load Drive**

Unloading from Tape Drives

The Unload Drive operation allows the Administrator to unload cartridges from a single tape drive to a storage slot, as long as they are in the same partition. The library/partition will be taken offline during the unload operation.

NB: When you are unloading tape drives, only drives loaded with media appear.

The paths to open the appropriate screens are:

- From the [RMI](#), select **Operations > UnLoad Drive**
- From the [FPI](#), select **Menu > Operations > UnLoad Drive**

Cleaning Tape Drives

Tape drives require periodic cleaning at recommended intervals. At least one cleaning slot must be configured to enable automatic cleaning of tape drives. Manual cleaning can be performed even if no cleaning slots are configured. On a manual clean request, the library will scan the cleaning slots, if any, and then the I/E slots for a cleaning cartridge.

If you want to use host-based cleaning, configure zero cleaning slots on the library and set up your host application to manage the cleaning process.

For more information on configuring cleaning slots, please refer to [Configuring Cleaning Slots](#).

Cleaning cartridges remove accumulated residue from the tape drive and the read/write head.

Importing Cleaning Media

The Import Media command previously described is also used to import cleaning media. To import cleaning media, you should open the I/E station and insert one or more cleaning cartridges. Once the I/E station is closed and the inventory has completed, the cartridges must be assigned to the Cleaning or System partition. If cleaning slots are configured, you may Import the cartridges to the cleaning slots. Each cleaning cartridge, when imported, is moved to the first free cleaning slot.

If no cleaning slots are configured, the cleaning cartridges assigned will remain in the I/E station.

Cleaning Media Handling

When a cleaning cartridge is imported into a cleaning slot, the cleaning count for that cartridge is set to zero. Each time the cartridge is used for drive cleaning, the cleaning count is incremented.

The tape drive will detect when the specified life-span of a cleaning cartridge has expired and report this back to the library. The cartridge is then flagged as expired and no longer used. The Administrator is prompted to export the expired cartridge and import a new one.

If the drive detects that a cartridge used for cleaning is a data cartridge, this is also reported to the library, as for expired cartridges. The cartridge is flagged as a data cartridge and not used. The Administrator is prompted to export the expired cartridge and import a new one.

Exporting Cleaning Media

The Export Media command previously described is used if you want to export a cleaning cartridge from a cleaning slot to the I/E station.

Auto Clean

If Auto Clean is enabled, and at least one cleaning slot is configured and stocked with a cleaning cartridge, the library will initiate cleaning when this is required. For more information on configuring cleaning slots and enabling Auto Clean, please refer to [Configuring the Library](#).

An automated cleaning operation is performed, if requested by the tape drive, when a cartridge is moved out of the drive. The response to the Move command will be delayed until the cleaning operation has been performed.

Manual Clean

Both the front panel and the remote management interface provide menu and command selections to perform manual drive cleaning operations. Manual drive cleaning operations allow the selection of a drive to be cleaned, regardless of the drive has requested cleaning or not. The library will automatically scan through the cleaning slots, if any, and select the most used cleaning cartridge. If there are no cleaning slots, or if there are no cartridges in these slots, the library will scan the I/E station for a cleaning cartridge.

When the cleaning has completed, the cleaning cartridge is moved back to its source location.

The paths to open the appropriate screens are:

- From the [RMI](#), select **Operations > Clean Drive**
- From the [FPI](#), select **Menu > Operations > Clean Drive**

Taking a Library Online/Offline

Taking a library online makes it accessible to host applications via the Storage Area Network (SAN). Taking a library offline makes it inaccessible to host applications via the SAN.

Taking a Library Online

1. Using the library's front panel or the remote management interface, select **Operations > Partition Mode**.
4. For each partition that you want to take online, click **Online**.
5. Click **Apply**.

Taking a Library Offline

1. Using the library's front panel or the remote management interface, select **Operations > Partition Mode**.
6. For each partition that you want to take offline, click **Offline**.
7. Click **Apply**.

Magazine Handling

The operator is allowed to eject any or all of the magazines in the library through the [FPI](#). This feature is not implemented in the [RMI](#) because there is no means to re-insert the magazine remotely.

The paths to open the appropriate screens are:

- From the [FPI](#) only, select **Menu > Operations > Eject Magazines**

As long as at least one magazine is present in the library, the library continues to operate normally.

Using the Mail Slot

There is no hard stop on the import/export slot.

When the system is configured for 3 I/E-slots please observe the following procedure:

- Open the lower left magazine until the three first magazine slots are accessible. Stop pulling the magazine at the stop line indicated on the mail slot label. By exceeding the stop line, the library cannot distinguish whether the whole magazine has been exposed or only the three first I/E slots. Thus when you re-insert the magazine the library will need to take an inventory check on all 12 slots instead of only the I/E slots.

Removing the Magazine from the Unit

The following illustration shows the correct way to remove the magazine from its bay.



Note

You cannot remove the magazine if the unit is password protected or locked by host software through a Prevent Medium Removal SCSI command.

When ejecting the magazine it automatically pops out a few inches. With one hand, grip the handle on the outer side of the magazine bezel and hold the other hand under the magazine. See [Figure 32](#). Pull out the magazine carefully, keeping it horizontally level with the library. If the magazine is filled with cartridges, be prepared for the weight of the magazine. Keep one hand underneath the magazine to prevent the back of the magazine falling down when it leaves the magazine bay.

Figure 32. Removing a Magazine from the Library

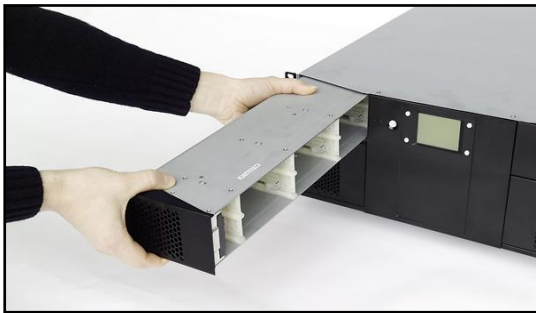

Inserting Cartridges into the Magazine

When inserting cartridges, the access door of the cartridge must face the magazine slot opening. Push the cartridge carefully into the magazine slot until it locks in place. See [Figure 33](#).

NOTE: The rear side of the cartridge with the Write Protect switch and the barcode label must be facing outwards. Make sure the cartridges latch properly. For handling of the cartridges in the magazines, see [Working With Cartridges and Barcodes](#).

Figure 33. Inserting a Cartridge into the Magazine Slot



a) Gently push the cartridge into the magazine slot until it locks in place. NOTE: The write protect switch and the barcode label (if any) must be facing outwards.

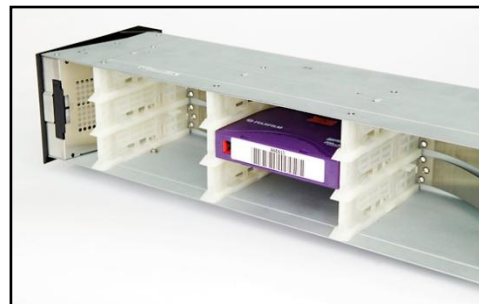

b) The cartridge locked in place. Make sure that the cartridge latch properly.

Removing Cartridges from the Magazine

Gently press the cartridge release tab towards the cartridge until the cartridge is released. See [Figure 34](#). The cartridge is spring loaded, so it is important to prevent the cartridge from popping all the way out.



Warning

Prevent the cartridge from falling down, in order to avoid possible damage or loss off data.

Figure 34. Ejecting a Cartridge from the Magazine Slot.



Gently press the cartridge release tab towards the cartridge until the cartridge is released.

Inserting a Magazine into the Unit

The right and left magazines are mirrored and can only be inserted into the correct left or right magazine bay.

1. Insert the back of the magazine into the correct magazine bay. Make sure it is horizontally level with the library.
2. Slide the magazine in carefully until the eject spring engages. See [Figure 35](#).
3. Gently push the magazine further in against the spring until the magazine is latched.

Figure 35. Inserting a Magazine into the Unit

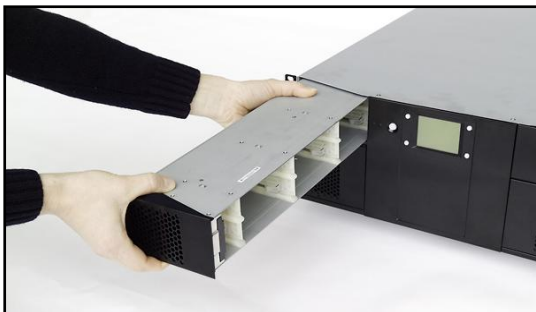

Manual/Emergency Release of Magazines

In failure situations (either with the library itself, in the event of a power loss, or in situations where you need to manually release the magazines), a manual/emergency release operation is available. To

activate the emergency magazine release feature, you must use the magazine release tool that is fastened to the back of the library. See [Figure 2](#). This tool must be inserted through the hole at the bottom of each magazine, as shown in [Figure 36](#).



Caution

Make sure you turn OFF the power before you use the manual emergency release tool

Figure 36. Ejecting a Magazine using the Emergency Release Tool



Ejecting the lower left Magazine by using the Emergency Release Tool. This tool must be inserted through the hole as shown in the picture above.

Standby Functionality

A standby button is available on the front panel.

To activate Standby mode, press the button for a minimum of 2 seconds. The StorageLibrary will enter a standby mode in a controlled manner. The following operations are performed before the StorageLibrary goes into standby mode:

1. Any current StorageLibrary activities are completed.
2. The power to the tape drives is switched off.
3. The display is turned off.
4. No StorageLibrary activity is allowed until the standby button is pressed again.
5. The green LED on the front will blink with short blinks over long intervals.
6. To leave the standby mode, press the standby button for 2 seconds. The StorageLibrary will then re-start and perform a full inventory check.

8

Getting Status and Information

Operator and Administrator can view information about the library by accessing items under the Reports menu.

The Reports Menu Information is available from both the front panel interface ([FPI](#)) and remote management interface ([RMI](#)). We recommend using the RMI to view the reports due to the limited amount of information it is possible to display on the compact LCD screen on the FPI. Also, the FPI reports show only a subset of the RMI reports.

The status information listed in this chapter constitutes the reports available from the RMI. For an overview of the reports available from the FPI, please refer to [Figure 28](#).

Library Settings

The Library Settings Report contains information on the following library settings:

- Inquiry string
- FPI Password - Enabled or Disabled
- Menu Timeout - from 1 to 9
- Barcode Scanner - Enabled or Disabled
- Date and Time - Current date and time
- Audible Alarm - enabled or disabled
- Library Serial Number (Library SN)
- Library Firmware Version (Library FW)

The path to open the library report from the [RMI](#) is **Reports > Library**.

Partition and Drive Information

The Partitions Setting Report is a dynamic representation of the physical locations of various library resources, including tape drives, magazine slots, partitions, and modules.

The following drive information is available from the Partitions Report:

- Drive Vendor Name <value>
- Drive Product Name <value>

- SCSI ID <value as applicable>
- Fibre Channel ID <value as applicable>
- Fibre Topology <value as applicable>
- Fibre Channel Speed <value as applicable>
- SAS Address <value as applicable>
- SAS Port Address <value as applicable>
- Assigned Partition <1, 2, 3, or 4>
- Control Path <Enabled, Disabled>
- Drive Serial Number (Drive SN) <value>
- Drive Firmware Version (Drive FW) <value>
- World-Wide Name
- World-Wide Node Name

The following partition and drive information is available from the Partitions Report:

- Partition Number
- Drive members <Drive ID>
- Magazine members
- Control Path <Yes or No, Drive ID>
- Status <online/offline>
- Total number of storage slots
- Total number of cartridges
- Barcode Reporting Mode <6 Character or 13 Character>
- Auto Clean <Enabled or Disabled>

The path to open the report from the [RMI](#) is **Reports > Partitions**.

Network

The Network Report provides information on the following library settings:

- Basic Network Settings: Address mode (static or dynamic), IP address, subnet mask, gateway, MAC address.
- Notification Settings: SNMP server, IP address, E-mail address, Notification enabled or disabled, Severity Level.
- Pass-Thru Settings: Pass-Thru mode, slave library IP address.

The paths to open the appropriate screens are:

- From the [RMI](#), select **Reports > Network**
- From the [FPI](#), select **Menu > Reports > Network**

Statistics

The Statistics Report contains the following statistics of the library:

- Number of Fetches
- Number of Stows
- Power On Time
- Time since drive cleaning

The paths to open the appropriate screens are:

- From the [RMI](#), select **Reports > Statistics**
- From the [FPI](#), select **Menu > Reports > Statistics**

Event Log

The Event Log Report provides information on library events and errors.

- Email Log
- Download Log
- Log

The path to open the report from the [RMI](#) is **Reports > Event Log**.

9

Adding, Removing and Replacing

This chapter describes how to add, remove, and replace hardware within your library. Adding, removing, or replacing library components requires you to power off the entire library if you do not have a redundant power supply system.

Power Supply Unit

These instructions explain how to remove and replace a power supply, how to add a second power supply to achieve a fully redundant power supply solution.

Figure 37. The Back of the Library



Replacing a Power Supply

These instructions explain how to remove a single power supply to replace it with a new one.

When adding a power supply, no interaction on the front panel or the remote management interface is necessary. If the library is fitted with two power supply modules, then it is possible to replace the power supply without switching off the power. For more information about replacing a second power supply, see [Hot-Swapping a Redundant Power Supply](#)



Caution

You must power off the library and remove power cords before performing this procedure.

Required tools: None

1. Prepare the host application for system shutdown.
2. Access the back of the library, and locate the power supply. See Figure 37.
3. Turn off the power of the library using the switch on the rear.
NOTE: T40+: Please turn off both power switches. The T40 has only one power switch.
4. Remove the power cord(s).
NOTE: T40+: Please remove both power cords. The T40 has only one power cord.
5. Loosen the power supply thumbscrews. Please ensure you loosen both screws simultaneously. See [Figure 38](#).
6. Remove the power supply by gripping the thumbscrews and pulling the power supply towards you.
7. Insert the new power supply into the empty power supply bay.
NOTE: The power supply must be installed horizontally level, and pushed gently into position. Do not apply excessive force when performing this operation.
8. Secure the power supply by tightening the power supply thumbscrews simultaneously.
NOTE: It is important that the two thumbscrews are tightened simultaneously.
9. Plug in the power cord (For T40+: Plug in the power cord at the AC-inlet marked **1**).
10. Turn on the power switch (For T40+: Turn on the power switch marked **1**).

Figure 38. Replacing a Power Supply



Adding a Redundant Power Supply

These instructions explain how to add a second (redundant) power supply.

It is possible to perform this operation without interrupting the operation of the library. No interaction on the front panel or the remote management interface is necessary when adding a power supply.

 **Caution** You must switch off the correct power switch and remove the correct power cord when performing this procedure. The correct switch and power cord are noted in this procedure.

Required tools: Screwdriver (Philips)

1. Access the back of the library, and locate the power supply. See Figure 37
2. Locate the power switch marked .

NOTE: Please ensure that you turn off the correct switch. Please refer to [Troubleshooting](#).

3. Turn off the power switch that you located in step 2.
4. Remove the blanking plate by loosening the two screws. See Figure 39a.
5. Insert the new power supply into the empty power supply bay. See Figure 39b.

NOTE: The power supply must be installed horizontally level and pushed gently into position. Do not apply excessive force when performing this operation.

6. Secure the power supply by tightening the power supply thumbscrews simultaneously. See Figure 39c.

NOTE: It is important that you tighten the two thumbscrews simultaneously.



7. Connect a new power cord for the AC-inlet marked .
8. Turn on the power switch marked .

Figure 39. Adding a second Power Supply



a) Remove the blanking plate.

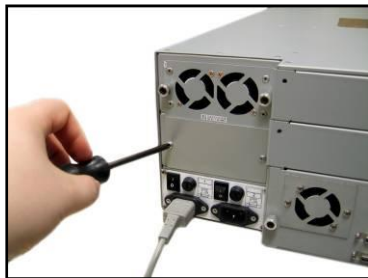

b) When inserting the power supply, keep it horizontally level to slide it in gently.



c) Tighten the two thumbscrews simultaneously.

Hot-Swapping a Redundant Power Supply

These instructions explain how to hot-swap a redundant power supply in T40+ if it is fitted with 2x power supplies.

It is possible to perform this procedure without interrupting the operation of T40. No interaction on the front panel or the remote management interface is necessary when adding a power supply.



Caution

You must switch off the correct power switch and remove the correct power cord when performing this procedure. The correct switch and power cord are noted in this procedure. To determine which power supply has failed, please refer to [Troubleshooting](#).

Required tools: None

1. Access the back of the library, and locate the power supply to be replaced. See [Figure 37](#).
8. Locate the switch and power cord belonging to the power supply that is to be replaced.
NOTE: Please ensure that you turn off the correct switch. Please refer to [Troubleshooting](#).
2. Turn off the power switch and disconnect the power cord that you located in step 2.
3. Loosen the power supply thumbscrews for the power supply to be replaced, making sure you loosen both screws simultaneously.
4. Remove the power supply by gripping the thumbscrews and pulling it towards you.
5. Insert the new power supply into the empty power supply bay. See [Figure 40a](#).
NOTE: The power supply must be installed horizontally level and pushed gently into position. Do not apply excessive force when performing this operation.
6. Secure the power supply by tightening the power supply thumbscrews simultaneously. See [Figure 40b](#).
NOTE: It is important that you tighten the two thumbscrews simultaneously.
7. Re-connect the power cord.
8. Turn on the power switch.

Figure 40. Hot-Swapping a Power Supply



a) When replacing the power supply, keep it horizontally level to slide it in smoothly.



b) Tighten the two thumbscrews simultaneously. Re-connect the power cord. Turn on the power switch.

Tape Drive Unit



Note

To make sure you do not interrupt your host system, we recommend that you power off your library before you add, remove or replace a tape drive unit.

Adding a Tape Drive

You can add tape drives so that your library contains four half-height drives, two full-height drives, or a combination of these.



Note

A full-height drive can occupy the bottom two half-height drive positions or the top two half-height drive positions, but NOT the middle two half-height drive positions.

These instructions explain how to add a tape drive to your library.

Required tools: Screwdriver.

1. Power-off the library. switching (both) the switch(es) off located at the back.
2. Detach the cover plate for the bay where the tape drive will be added. Use a screwdriver to loosen the cover plate screws and remove the plate. Save the cover plate. If you later decide to remove the tape drive, you will need to re-install the cover plate.
3. Insert the tape drive into the drive bay. Using the guide rails on both the tape drive and in the drive bay, slowly slide the tape drive into the bay. The tape drive must be horizontally level for it to slide in smoothly.
4. Tighten the thumbscrews to secure the tape drive to the module.

The thumbscrews must be aligned with the module's screw holes. If they are not aligned, the tape drive will not be inserted correctly. Tighten the thumbscrews simultaneously.
5. Connect the host interface cables to the tape drive. If the tape drive is a SCSI drive, and the drive is the last device on the bus, you must also connect the SCSI terminator.
6. Power-on the library.
7. Run the setup wizard from the front panel or the remote management interface.
8. Update Drive firmware by following the instructions provided in [Updating Firmware](#).



Note

If you do not have a cover plate, order a replacement. To keep unwanted materials out of the library, it is important that all empty drive bays have a cover plate.

Permanently Removing a Tape Drive

These instructions explain how to remove a tape drive that you do not intend to replace with another one.

You CANNOT remove a tape drive while the library is powered on.

Required tools: Screwdriver.

1. Prepare host applications for tape drive removal.
2. Using the remote management interface or the front panel interface, remove the drive from the partition that uses the target tape drive.
3. If there is a cartridge in the target tape drive, use the remote management interface or the front panel interface to eject it.
4. Turn the library off using the switch(es) located at the back.
5. Disconnect the host interface cables from the tape drive that you want to remove.
6. From the back of the library, loosen the tape drive thumbscrews.
7. Remove the tape drive by gripping the thumbscrews and pulling the entire drive unit towards you.

8. Install cover plates over the empty drive bay. Use a screwdriver to mount the plates.

If you do not have enough cover plates, order replacements. It is important that all empty drive bays have cover plates to keep unwanted materials out of the library.



Warning

Running the library without a cover plate can be dangerous.

Removing and Replacing a Tape Drive

These instructions explain how to remove a tape drive and replace it with a new one.

Required tools: None.

1. Prepare host applications for tape drive removal.
9. If there is a cartridge in the Drive, use the remote management interface to eject it.
2. Turn the library off using the switch(es) located at the back.
3. Disconnect the host interface cables from the tape drive that you want to remove.
4. From the back of the library, loosen the tape drive thumbscrews.
5. Remove the tape drive by gripping the thumbscrews and pulling the entire tape drive towards you.
6. Add the new tape drive to the empty drive bay. Using the guide rails on both the tape drive and the tape drive bay, slowly slide the tape drive into the bay. The tape drive must be level in order to slide it in smoothly.
7. Tighten the tape drive's thumbscrews to secure the tape drive to the module. Tighten the thumbscrews simultaneously. See Figure 41.
The thumbscrews must be aligned with the module's screw holes. If they are not aligned, the tape drive was not inserted correctly.
8. Connect the host interface cables to the tape drive. If the tape drive is a SCSI drive, and the drive is the last device on the bus, you must also connect the SCSI terminator.
9. Power-on the library.
10. If necessary, update Drive firmware by following the instructions provided in the Updating Firmware.

Figure 41. Adding or Removing a Tape Drive



10

Updating Firmware

The Administrative User is able to update firmware on the StorageLibrary. The latest firmware versions for the library can be found on <http://www.tandbergdata.com>.

You can also regularly monitor the website for firmware updates, but you need to make sure that the firmware you download is compatible with your library and tape drives.

There are two types of firmware that can be updated on the library: library firmware and tape drive firmware. This chapter explains how to update both the library firmware and the tape drive firmware.

Updating Library Firmware

Using the **Update Library Firmware** command, you can install new library firmware from the remote management interface ([RMI](#)).



Caution

If you choose to update tape drive firmware during this procedure, make sure that NO cartridges are loaded in any of the tape drives.

Update the library application firmware using the following steps:

1. Download the Library Firmware.
 - a. Access <http://www.tandbergdata.com>.
 - b. Select “Service” / “Support by Product”. Then choose “StorageLibrary” and “StorageLibrary T40”.
 - c. Verify with technical support or published Release Notes that you are selecting the correct firmware version to download.
 - d. Select the appropriate firmware version and download the files to your computer.
10. Update Library Firmware.
 - e. Update the library application firmware using the **Library FW Upgrade** command on the **Tools > Maintenance** menu from the [RMI](#).

Note: The **Allow Remote FW upgrade** must be enabled in the **Menu > Setup > Network** menu from the [FPI](#).
 - f. Browse to the firmware file that was downloaded in Step 1 and apply the selection.
 - g. Click on the “Upgrade” button. The upgrade process has now started.



Caution

Once the update process has started, you must wait until it completes. Do **NOT** attempt to interrupt the process in any way, or loss of either data or library operability could result.

2. Open **Reports > Library** on the library to verify that the library firmware was updated.

*NOTE: After uploading the file, the **RMI** is inoperable. The progress of the FW upgrade process is displayed on the front panel interface (**FPI**). The library reboots when the FW upgrade has completed. The library is now accessible on the **RMI**.*

Updating Drive Firmware

Update the tape drive firmware using TDkit software available at <http://www.tandbergdata.com>. TDkit is available for Windows 2000, Windows 2003 and Windows XP. *TDkit USER's GUIDE* is available in the TDkit folder after installation.

You should normally update firmware on all of the tape drives in the library at the same time to make sure that they are all at the same firmware level. You should avoid using different levels of tape drive firmware in the library.

It is important to make sure that the library is running the appropriate level of tape drive firmware, compatible with the tape drive type. To determine the appropriate tape drive firmware, please refer to the library's *Release Notes*, or contact Technical Support.

After you have identified the need to update tape drive firmware on one or more tape drives, use the following steps to load the firmware onto the tape drives:

1. Install TDkit software.
 - a. Download and install TDkit. It is available at <http://www.tandbergdata.com>.
 - b. Read the *TDkit USER's GUIDE* located in the TDkit folder.
 - c. Run TDkit. When started, the program displays all detected SCSI devices. If not, click **Function** in the top menu, and then click **SCSI rescan**.
NOTE: Most Windows operating systems require that all backup services started by the backup software application must be stopped before the TDkit utility is started.
 - d. Make sure the computer has detected the tape drive. (Look for "Tape drives" in the "Device Manager": Right click "My Computer" – "Manage" – "Device Manager").
2. Download Drive Firmware
 - a. Access the drive manufacturer's web site and download the firmware file to your computer.
 - b. From the home page, navigate to your product's firmware.
 - c. Verify from the published Release Notes or Tandberg Technical Support that you are selecting the correct firmware version to download.
 - d. Select the appropriate firmware version and download the files to your computer's hard drive. Download the firmware to a known location on your computer.
3. Update Drive Firmware
 - a. Start the TDkit utility and select the appropriate tape drive in Device overview tab.
NOTE: If you are using 3rd party device driver for the tape drive, e.g. from a backup software application, this must be temporarily disabled before flashing new firmware. This can be performed in the Computer Management > Device Manager.
 - b. Click the **Device configuration** tab, then click **FW update** button.
 - c. Follow the instructions in the program.



Caution

Once the update process has started, you must wait until it completes. Do **NOT** attempt to interrupt the process in any way, or loss of either data or library operability could result.

4. Verify Drive Firmware Update

- a. In TDkit, click **Device Overview** and take a look at the label **FW revision**; below the picture of the tape drive.

NOTE: Be aware that some tape drives do not report when flashing is finished. Wait 5 minutes before rebooting the StorageLibrary.

It is also possible to verify the drive's FW version using either the StorageLibrary front panel or remote management interface. The paths to open the appropriate screen are:

- From the [RMI](#), select **Reports > Partitions**
- From the [FPI](#), select **Menu > Reports > Drive**

11

Working With Cartridges and Barcodes

This chapter describes how to work with cartridges and barcodes. When working with cartridges, there are certain considerations that should be taken into account. It is recommended that all cartridges in the library should have a barcode label. In addition, when loading your library, you should be aware of whether or not your cartridges are write-protected.

This section discusses these types of items in general terms. Please refer to [Approved Drive Types](#) for information on what type of tape cartridges are supported for specific tape drive types.

It is recommended that you allocate a cleaning cartridge to each library partition.

Handling Cartridges Properly

To secure the longest possible cartridge life-span, we recommend that you follow these guidelines:

- Select a visible location in order to post procedures that describe proper media handling.
- Ensure that anyone who handles cartridges has been properly trained on all procedures.
- Do not drop or strike cartridges. Excessive shock could damage the internal contents of cartridges or the cartridge casings themselves, rendering the cartridges unusable.
- Do not expose cartridges to direct sunlight or sources of heat, including portable heaters and heating ducts.
- Do not stack cartridges more than five high.
- The operating temperature range for LTO cartridges is 10°–35°C. The storage temperature range is 16°–32°C in a dust-free environment, with a relative humidity range between 20%–80% (non-condensing).
- If cartridges have been exposed to temperatures outside the ranges specified above, stabilize the cartridges at room temperature for the same amount of time that they have been exposed to extreme temperatures, or for 24 hours, whichever is less.
- Do not place cartridges near sources of electromagnetic energy or strong magnetic fields, such as computer monitors, cellular phones, electric motors, speakers, or x-ray equipment. Exposure to electromagnetic energy or magnetic fields can destroy data and the embedded servo code written on the media by the cartridge manufacturer, rendering the cartridges unusable.
- Place identification labels only in the designated slots on the cartridges.
- If you ship cartridges, ship them in their original packaging or something stronger.
- Do not insert damaged cartridges into tape drives.
- Avoid touching the tape or tape leader.



Caution

Do not degauss cartridges that you intend to re-use.

Write-Protecting Cartridges

All cartridges have a write-protect (write-inhibit) switch to prevent accidental erasure or overwriting of data. The switch is located on the left side of the cartridge front. To write-protect the cartridge, slide the red or orange write-protect switch to the right so that the padlock shows in the closed position. See [Figure 42](#).

Before loading a cartridge into the library, make sure the write-protect switch is positioned correctly (either on or off).

Figure 42. Cartridge Write-Protect Switch and Correct Label Location



a) Write-protected cartridge
(The red write-protect switch slid to the right)



b) Write-enabled cartridge
(The red write-protect switch slid to the left)

Barcode Requirements

It is recommended that the barcode label is both machine and operator-readable. A barcode must use only uppercase letters A to Z and/or numeric values 0–9. The library supports barcode symbology “Code 39”.



Caution

To ensure reliable functionality of the barcode reader, you must use StorageLibrary specific barcode labels supported by Tandberg Data.

Attaching Barcode Labels

It is recommended that cartridges have an external barcode label. For purposes of identifying the barcode, it is recommended that the label is both machine and operator-readable.

All barcode labels must be attached to the front of a cartridge. Peel off the label and place it on the cartridge. Verify that the label is positioned as illustrated in [Figure 42](#). You should avoid attaching stickers or labels to the top or bottom of the cartridge, since if the labels become loose, they may get caught in the tape drives, or else become scanner unreadable.



Caution

Place the barcode label ONLY according to [Figure 42](#). Placing the label elsewhere may cause failure or possible damage to the library.

12

Troubleshooting

The library includes advanced system monitoring and alerting mechanisms that inform you of library status and issues. It also notifies you of the issues it detects, and guides you through diagnosing and correcting issues before problems otherwise start to interfere with backups.

This chapter describes commands that you can select from the **Tools** menu to monitor the library, configure and test tape drives, work with connectivity, e-mail current logs, and save and restore library configurations.

About RAS Tickets

The library uses advanced problem detection, reporting, and notification technology to alert customers of problems as soon as they occur. The library performs numerous self-tests to monitor the library's temperature, voltage and currents, and standard library operations. It performs these self-tests each time the library is powered on, and during normal operation when the library is idle.

If the self-test detects a problem, the library generates a service report, or RAS ticket, which identifies which component is probably causing the problem. The library's LEDs may also turn on or off and flash to indicate an abnormal state. If the problem is not severe, the library continues to provide full functionality to all unaffected partitions.

Whenever possible, the library provides instructions for resolving problems. These instructions appear on the library's front panel, and are also available via the remote management interface. Access the library's online Help system if you have questions about the instructions provided.

Viewing RAS Tickets

You can view library RAS tickets from the **Reports** menu on both the front panel and the remote management interface. RAS tickets are special service reports that summarize the current reliability, availability, and serviceability of the library. RAS tickets provide detailed information about system problems. From the remote management interface and the front panel interface, this view lists all of the library RAS tickets in the order in which they were created, starting with the most recent. All RAS tickets are considered unopened until a user clicks **OK**. After you click **OK**, the ticket is considered opened.

Also included on the RAS tickets log is an explanation of what error the library encountered.

The paths to open the appropriate screens are:

- From the [RMI](#), select **Reports > RAS tickets**
- From the [FPI](#), select **Menu > Reports > RAS tickets**

Closing RAS Tickets

After using the information in the RAS ticket to resolve your library issue, use the prompts on the screen to close the RAS ticket.

Supported RAS Tickets

Table 4. Supported RAS Tickets

RAS Ticket	Severity Level	Display Message	Description	Suggested Action
R01ZZ	High	Diagnostic number ZZ failed.	The diagnostics number ZZ failed.	Reboot the loader and retry the operation.
R0200	Urgent	Initialization of the robotics failed.	The robotics failed to complete the calibration or the inventory sequence.	Reboot the loader and retry the operation. Verify that the magazines are locked. Turn off the loader and try to remove the magazines by using the emergency eject pin. Contact your service representative.
R0201	High	The Fan is stuck.	The fan is stuck.	Please verify that the fan is not mechanically blocked. If the fan is stuck due to dust, please clean the fan. Reboot the loader and retry the operation. If the problem persists please contact technical support to replace the defective fan.
R0202	High	The Fan is not running.	The fan is not running.	Please verify that the fan cables are connected. Reboot the loader and retry the operation. If the problem persists please contact technical support to replace the defective fan.
R0203	Urgent	Robot Inventory failure. Too many cartridges	Too many cartridges has been detected during the inventory sequence.	Please eject the magazine and remove one cartridge.
R0204	Urgent	The system has reported an unmanaged fault.	An unidentified problem has occurred.	Reboot the loader and retry the operation. If the problem persists please contact technical support.
R0205	High	Drive-n cleaning failed. No cleaning tape present.	The cleaning operation failed because no cleaning cartridge is present in the system.	Please import a cleaning media. To import cleaning media, you should open the I/E station and insert one or more cleaning tapes. The cartridges must be assign to the Cleaning or System partition.

(table continued on next page...)

RAS Ticket	Severity Level	Display Message	Description	Suggested Action
R0206	High	Drive-n cleaning failed. Expired cleaning tape.	The cleaning operation failed due to an expired cleaning tape.	Please remove the expired cleaning media from the system, and import a new cleaning media. To import cleaning media, you should open the I/E station and insert one or more cleaning tapes. The cartridges must be assign to the Cleaning or System partition.
R0207	High	Cleaning cartridge in drive-n. Can not be moved home.	An cleaning cartridge has been found in one of the drives witch can not be moved home.	All I/E and cleaning slots are occupied. Please remove a tape from the I/E station, or from the cleaning slots, or use the Unload Drive command to move the cleaning cartridge from the drive. When a cartridge has been removed, please reboot the loader and retry the operation.
R0208	High	Drive-n cleaning failed. Invalid cleaning tape.	The cleaning operation failed due to an invalid cleaning tape.	Please remove the invalid cleaning media from the system, and import a new cleaning media. To import cleaning media, you should open the I/E station and insert one or more cleaning tapes. The cartridges must be assign to the Cleaning or System partition.
R0210	High	Power loss detected on power source #1.	Power loss detected on power source #1.	Power loss detected on power source #1. This failure can be caused by an AC power loss, the power supply being turned off, the power cable not being inserted properly, or a Power CRU hardware failure.
R0211	High	Power loss detected on power source #2	Power loss detected on power source #2.	Power loss detected on power source #2. This failure can be caused by an AC power loss, the power supply being turned off, the power cable not being inserted properly, or a Power CRU hardware failure.
R1001	Urgent	Failed moving the robotics.	The robotics was not able to move.	Reboot the loader and retry the operation.
R1100-R1128	Urgent	Failed to stow at slot n.	The robotics is not able to stow the cartridge to the magazine	Reboot the loader and retry the operation. Remove the magazine if possible. Remove all cartridges. Verify that the cartridge is not damaged. Insert empty magazines. Power cycle the loader. Retry the operation. Retry the operation with a new magazine.

RAS Ticket	Severity Level	Display Message	Description	Suggested Action
R1129- R112C	Urgent	Failed to stow at drive n.	Failed to insert cartridge in drive	Reboot the loader and retry the operation. If failure persists, insert the cartridge into a magazine slot, remove the magazine and verify that the cartridge is not damaged. If failure persists, replace the drive CRU.
R1200- R1228	Urgent	Failed to fetch at slot n.	The robotics is not able to fetch the requested cartridge from the magazine	Reboot the loader and retry the operation. Remove the magazine if possible. Remove all cartridges. Verify that the cartridge is not damaged. Insert empty magazines. Power cycle the loader. Retry the operation. Retry the operation with a new magazine
R1229- R122C	Urgent	Failed to fetch at drive n.	Failed to fetch cartridge in drive	Reboot the loader and retry the operation. If failure persists, replace the drive CRU.
R2000	Urgent	No drive detected	The library is not able to detect the drive.	Please verify that the drive CRU is installed. Reboot the loader and retry the operation. If the problem persists please contact technical support.
R2001	Urgent	Drive hardware fault is detected	The library has detected a drive hardware fault.	Please verify that the drive CRU is installed. Reboot the loader and retry the operation. If failure persists, replace the drive CRU.
R2002	Low	Drive firmware update available	A firmware update is available for the tape drive	Update the drive firmware to the latest version available from http://www.tandbergdata.com .
R2003	Urgent	Drive firmware update recommended	A firmware update is recommended for the tape drive.	Update the drive firmware to the latest version available from http://www.tandbergdata.com .
R3000	Urgent	The Pass-Thru system is not correctly installed.	The library was not able to move the Pass-Thru box between the systems.	Please verify that the blind plate has been removed, and that the systems are correctly installed into the rack.
R3001	Urgent	The Pass-Thru magazine is not in place	The Pass-Thru magazine is not in place.	Please insert the Pass-Thru magazine and retry the operation.

RAS Ticket	Severity Level	Display Message	Description	Suggested Action
R3002	Urgent	The Pass-Thru box is not in place	The Pass-Thru box is not in place.	Eject the Pass-Thru magazine and insert the Pass-Thru box. Re-insert the Pass-Thru magazine and retry the operation.
R3003	Urgent	The Pass-Thru box is not empty	A cartridge has been detected in the Pass-Thru box.	Eject the Pass-Thru magazine and remove the cartridge from the Pass-Thru box. Re-insert the pass-thru magazine and retry the operation.
R3004	Urgent	Network connection failed	The master library is not able to connect to the add-on library.	Verify the TCP/IP addresses in the pass-thru configuration, and that the network connection between the master and the add-on library is working.
R3005	Urgent	Pass-Thru configuration failed	The master library is not able to configure to the add-on library.	Verify that all libraries in the pass-thru system are using the same firmware revision. Also verify that the TCP/IP communication between the master and the add-on library is working. Reboot and retry the operation
R3006	Urgent	Pass-Thru is disabled in the add-on library	The Pass-Thru functionality is disabled in the add-on library.	Please run the Setup Wizard on the add-on library and set the Pass-Thru configuration to "Add-on".
R6005	High	Drive n Tape Alert 5. Read Failure.	The tape is damaged or the drive is faulty.	Clean the drive. Try another cartridge. If the problem persists, replace the tape drive.
R6006	High	Drive n Tape Alert 6. Write Failure.	The tape is from a faulty batch or the tape drive is faulty.	Clean the drive. Use a good tape to test the drive. If the problem persists, replace the tape drive.
R6007	High	Drive n Tape Alert 7. Media Life.	The tape cartridge has reached the end of its calculated useful life.	Copy any data you need to another tape Discard the old tape.
R6008	High	Drive n Tape Alert 8. Not Data Grade.	The tape cartridge is not data-grade. Any data you back up to the tape is at risk.	Replace the cartridge with a data-grade tape.
R6009	High	Drive n Tape Alert 9. Write Protect.	You are trying to write to a write-protected cartridge.	Remove the write-protection or use another tape.

RAS Ticket	Severity Level	Display Message	Description	Suggested Action
R6012	High	Drive n Tape Alert 12. Unsupported Format.	You have tried to load a cartridge of a type which is not supported by this drive.	Use another tape.
R6020	High	Drive n Tape Alert 20. Clean Now.	The tape drive needs cleaning.	If the operation has stopped, eject the tape and clean the drive If the operation has not stopped, wait for it to finish and then clean the drive. Check the user manual for cleaning instructions.
R6022	High	Drive n Tape Alert 22. Expired Cleaning Media.	The last cleaning cartridge used in the tape drive is worn out.	Discard the worn out cleaning cartridge. Wait for the current operation to finish. Then use a new cleaning cartridge.
R6030	High	Drive n Tape Alert 30. Hardware A.	The tape drive has a hardware fault.	Eject the tape. Reset the drive. Re-start the operation.
R6031	High	Drive n Tape Alert 31. Hardware B.	The tape drive has a hardware fault.	Turn the tape drive off and then on again. Re-start the operation. If the problem persists, call the tape drive supplier helpline.
R6032	High	Drive n Tape Alert 32. Interface.	The tape drive has a problem with the host interface.	Check the cables and cable connections. Re-start the operation.
R6034	High	Drive n Tape Alert 34. Download Fail.	The firmware download has failed because you have tried to use the incorrect firmware for this tape drive.	Obtain the correct firmware and try again.
R6036	High	Drive n Tape Alert 36. Drive Temperature.	Environmental conditions inside the tape drive are outside the specified temperature range	Verify that the drive CRU fan is running.
R6039	High	Drive n Tape Alert 39. Diagnostics Required.	The tape drive may have a fault.	Check for availability of diagnostic information and run extended diagnostics if applicable. Check the tape drive users manual for instructions on running extended diagnostic tests and retrieving diagnostic data

Interpreting LEDs

LEDs provide a visual indication of the status of certain library components. LEDs can sometimes communicate that a problem exists when the RAS ticket cannot. For example, a LED can indicate a firmware problem that prohibits the library from generating RAS tickets.

The following components of the library have LEDs:

- Front Panel
- Ethernet Connector

The Maintenance Menu

Table 5. Maintenance Menu - Item Name and Description

Item name	Description
Library FW upgrade	Upgrades the library FW through RMI
Prepare to Ship	When selected, the robotics is positioned for installing the transport locking screws. The magazines are ejected to facilitate the installation. The library cannot be safely shipped with cartridges in the magazines. The Prepare to ship command must be run before the library is transported, in order to re-install the transport locking screws and to remove all cartridges in the library. The Prepare to ship command is available at the Front Panel Interface (FPI).
Reboot	Performs a hard reset of the library.
Restore default	Sets the library settings to their factory default values.
Clear WEB password	Clears the WEB password (from FPI only)

The Diagnostics Menu

Table 6. Diagnostics Menu - Item Name and Description

Item name	Description
Event log	Displays a log that contains information about library and drive configuration, event log and error log. This log can be saved to a file or sent via e-mail to technical support.
System test	Runs a test of the library hardware.
Cycle test	Starts a test where cartridges are moved randomly between magazine slots and between the drive and the magazines.

Verifying Hardware

1. If you are using SCSI, the library uses one SCSI ID for each SCSI tape drive. Verify that the drive SCSI IDs are set to unique SCSI IDs that are not used by any other SCSI device on the same bus. Depending on other devices attached to the same SCSI bus and their SCSI IDs, you may need to change the SCSI ID of the tape drive(s) before you can use the library.
2. Verify that the system recognizes the tape drives during the boot process.
3. Verify that the SCSI host adapter recognizes the tape drives during its initialization.
4. Verify that the SAS host adapter supports SAS tape drives.
5. Verify that the status on the library's front panel interface is OK.
6. Verify that the power cable is inserted correctly.
7. Verify that the cables are properly connected at both ends. Check that the cables are not damaged. If you are using SCSI, verify the lengths of your SCSI cabling. The length of the internal SCSI cabling inside the library is 26.4 cm (10.4 inch). This length must be included in any calculation of cable length.
8. If you are using SCSI, verify that the SCSI bus is properly terminated. Only devices physically at the beginning and end of the cable must be terminated.

Software Checking

1. Verify that the controller can see all devices during boot sequence. If not, enter HBA-bios (Host Bus Adapter) and check that LUN-scanning is enabled. It might be disabled by default.
2. Verify that operating system can see all devices, both robotics and tape drives.
3. Verify that drivers are loaded properly. Some applications use their own drivers so the device should appear "unknown" in the device manager. Drivers from the hardware vendor should normally be preferred.
4. Verify that the Backup software detects loader and drives properly and does not report errors. Run "Device Configuration Wizard" again if needed.

Verifying Recent Changes

If the library has been installed previously and operated correctly but is now incurring a problem, verify any recent changes to the system to ensure that these changes are not causing the problem. Try the following:

1. If the system configuration has changed: Remove the change to see if it affected the library.
2. If an operating system corrective patch has been installed: Remove it to see if it affected the library.
3. If a SCSI device has been added: Check for SCSI ID conflicts.
4. If a SCSI device has been added: Check to see if the SCSI termination has been properly set.
5. If a tape drive has been added or removed, please run the library's Setup Wizard again.

Troubleshooting Matrix

The tables below describe different problem situations and suggested actions to try to resolve the problem.

Table 7. Troubleshooting Matrix - Power with Solution

Problem	Solution
Power	
Library does not power on	<p>Check the power cord connections and check that the power cords are connected in the correct AC-inlet.</p> <p>Make sure there is power to the outlet. Try another working outlet.</p> <p>Verify that the power supply is properly inserted into the bay.</p> <p>Check that the correct power switches are in the ON position.</p> <p>Replace the power cord.</p> <p>Make sure the fuses are not blown. Replace the fuse with a 250V / 2A fast fuse if blown.</p> <p>Replace power supplies.</p> <p>Contact your service representative.</p>
The display is dead	<p>Check the power cord connections and check that the power cords are connected in the correct AC-inlet.</p> <p>Make sure there is power to the outlet. Try another working outlet.</p> <p>Verify that the power supply unit is properly inserted into the bay.</p> <p>Check that the correct power switches are in the ON position.</p> <p>Power cycle the library. If you use redundant power supplies, remember to turn both switches OFF. Verify that the fans start at power-on and that they calm down after a few seconds.</p> <p>Replace the power cord.</p> <p>Make sure the fuses are not blown. Replace the fuse with a 250V / 2A fast fuse if blown.</p> <p>Replace power supplies.</p> <p>Contact your service representative.</p>
The front panel does not display information but the back light on the front panel is on	<p>Power cycle the library. If you use redundant power supplies, remember to turn both switches OFF.</p> <p>Verify that the fans start at power on and that they stop after a few seconds.</p> <p>Contact your service representative.</p>

Table 8. Troubleshooting Matrix - Cartridge Movement with Solution

Problem	Solution
Cartridge Movement	
Library does not take inventory	<p>Make sure the transport screws are removed.</p> <p>Make sure all magazines are in their locked position.</p> <p>Write down any error information given on the FPI or RMI.</p> <p>Contact your service representative.</p>
Cartridge stuck in drive	<p>Power cycle the library. If you use redundant power supplies, remember to turn both switches OFF. Allow both the library and the drive to complete initialization, which in rare cases can take as long as 10 minutes, and then retry unloading the tape from the FPI or RMI.</p> <p>Make sure that the backup software is not reserving the slot or preventing the tape drive from ejecting the cartridge. The backup software needs to cancel the reservation and any hold it has on the tape drive.</p> <p>Temporarily disconnecting the library from the host server system eliminates the host system and its software as a problem source.</p> <p>Remove the tape drive unit from the drive bay. Connect power to the drive either by connecting it to the library's power supply or to an external power supply. Try to eject the cartridge by pushing the drive's eject button. The drive unit can be connected to the library's power supply by using the power extension cable located behind the battery holder cover plate on the back of the library.</p> <p>Follow the drive's emergency eject procedure to remove the cartridge from the drive.</p> <p>Replace the tape drive unit.</p> <p>Contact your service representative.</p>
Cartridge stuck in magazine	<p>Eject the magazine using the front panel interface. Manually remove the cartridge from the magazine slot.</p> <p>Contact your service representative.</p>
Cartridge stuck in robotics	<p>Power cycle the library. If you use redundant power supplies, remember to turn both switches OFF.</p> <p>Write down any error information given on the FPI or RMI.</p> <p>Contact your service representative.</p>
Failed to move cartridges	<p>Write down any error information given on the FPI or RMI.</p> <p>Contact your service representative.</p>
Failed to insert cartridge into drive	<p>Check failing media for pin damage (buckling pin).</p> <p>Hold the cartridge in your hand with the Write Protect Switch to your left and orientation arrow pointing away from you. On the right side, all the way in front, is a small door that can be opened by sliding a door towards you. Inside the cartridge you should see a metal pin. The pin must be parallel with the cartridge front and is held in place by two metal grippers at each end (top and bottom of the cartridge). The media should be attached to this pin. You see only the top and bottom part of the pin. If the pin is missing, loose or damaged, the tape will be damaged and rejected from the drive.</p>

Table 9. Troubleshooting Matrix - Media with Solution

Problem	Solution
Media	
Media barcode labels	<p>Make sure the barcode labels are applied in the correct orientation on the cartridge. See Labeling Cartridges for the Barcode Reader.</p> <p>Make sure there are no wrinkles on the label.</p> <p>Make sure that StorageLibrary specific labels are used.</p> <p>If all of the above are OK, replace the label with a new one.</p> <p>If problem continues, contact your service representative.</p>
Data cartridge incompatible with drive	<p>Make sure you are using a data cartridge that is compatible with the drive. See the tape drive's reference manuals for details.</p> <p>The SW backup application detects if an incompatible data cartridge is used, and communicates this to the user.</p> <p>Remove the cartridge from the library.</p>
Cannot write to, or read from, tape	<p>Make sure that the cartridge is write enabled (move the write-protect switch to the enabled position).</p> <p>Make sure that the cartridge has not been written using an incompatible format.</p> <p>Make sure that the cartridge is an acceptable format for your drive type. See the tape drive reference manuals for details.</p> <p>Make sure the cartridge has not been exposed to harsh environmental or electrical conditions or is not physically damaged in any way.</p> <p>Many backup applications do not read or write to cartridges that were created using a different backup application. In this case, you may have to perform an erase, format, or label operation on the cartridge.</p> <p>Make sure you understand any data protection or overwrite protection schemes that your backup application may be using, which could prevent you from writing to a given cartridge.</p> <p>Retry the operation with a different, known good tape.</p> <p>Clean the tape drive. See Cleaning Tape Drives.</p>

Table 10. Troubleshooting Matrix - SCSI with Solution

Problem	Solution
SCSI problems	
Changed SCSI ID, but the host server system does not recognize the new ID	<p>Make sure that all SCSI devices on the same bus have unique ID numbers.</p> <p>If the SCSI bus is narrow (50-pin) only SCSI IDs 0 through 7 are available.</p> <p>Make sure that you reboot the library after changing the SCSI ID.</p> <p>Reboot the host server system.</p>
The tape drive does not respond on the SCSI bus to the host	<p>Verify that a SCSI terminator is attached to both the last and first SCSI device on the SCSI bus.</p> <p>Verify that the SCSI cables are connected to the back of the library. See Connecting SCSI Cables.</p> <p>Make sure that the correct host controller card is installed.</p> <p>Verify that the SCSI cables are not damaged and that the total</p>

Problem	Solution
SCSI problems	
	<p>SCSI cable length does not exceed the maximum required length.</p> <p>Verify that the drive SCSI IDs are set to unique SCSI IDs that are not used by any other SCSI device on the same bus.</p> <p>Verify that the host application and the device drivers are installed with the most recent patches to support the tape drive.</p> <p>Issue a system reset from the front panel or remote management.</p> <p>Make sure the tape drive is properly inserted into the bay.</p> <p>Power cycle the library. If you use redundant power supplies, remember to turn both switches OFF.</p> <p>Reboot the host system when the library has completed its power on sequence.</p> <p>Contact your service representative.</p>

Table 11. Troubleshooting Matrix - Library Performance with Solution

Problem	Solution
Library Performance	
The library is not efficiently backing up data	<p>Check the network bandwidth from the host system. If you are backing up data over a network, consider comparing to a local-only backup.</p> <p>Verify that the host application and the device drivers are installed with the most recent patches to support the tape drive and the library.</p> <p>Make sure that you don't have any bottlenecks in the path between the tape drive and the SAS host controller. If you use SAS extenders, make sure that the extenders have the same or higher maximum speed than the tape drive and host controller.</p> <p>Connect the library to a LVD SCSI bus and make sure there are no SE devices on the same bus, otherwise this will cause the entire bus to negotiate down to SE speed.</p> <p>Clean the tape drive. See Cleaning Tape Drives.</p> <p>Try a new cartridge. A marginal cartridge can cause performance problems due to bad spots on the tape requiring retries.</p> <p>Backing up compressed data lowers performance.</p> <p>Check the size of the files. Small file size can impact performance.</p>

Table 12. Troubleshooting Matrix - Cleaning with Solution

Problem	Solution
Cleaning	
Cannot load the cleaning Cartridge	<p>Make sure there is no cartridge present in the drive before you load a cleaning cartridge.</p> <p>Make sure the cleaning cartridge has not expired.</p> <p>Contact your service representative.</p>

Table 13. Troubleshooting Matrix - Write or Read Issues with Solution

Problem	Solution
Write or Read Issues	
Contaminated head	Avoid contamination by ensuring that the library is installed in a clean, contamination-free environment. Cartridges should be stored vertically in their plastic cases. Continue cleaning the tape drive as needed. If a cleaning cartridge is not successful in resolving the problem after 3 or more attempts, the cleaning cartridge may be contaminated and should not be used in another drive.
Non-acclimatised media	A cartridge should be acclimatised for at least 24 hours before being used, particularly if it has been stored at a substantially different temperature or level of humidity than the library.
Cleaning cartridge is Incompatible	Make sure you are using a permitted cleaning cartridge.
Expired cleaning cartridge	Verify the number of cleanings per cleaning cartridge for your media type.
Bad/defective/contaminated media	If the write/read errors persist and the drive has been cleaned, that cartridge should be suspected as being defective, unless it is an invalid cleaning cartridge. If this occurs, export the cartridge and load a known good cartridge. In some cases, a cartridge can be worn out, have a defective cartridge memory, or it may have been formatted as a Firmware Upgrade Tape. Any cartridge that is suspected of being defective or contaminated should NOT be re-used in any drive.

Table 14. Troubleshooting Matrix - LED Error Messages with Solutions

Problem	Solution
LED Error Messages	
Amber LED on	When the amber LED is on, the library has encountered an electrical or mechanical failure. An error message will be displayed on the front panel (and RMI). Please refer to Supported RAS Tickets for details.

Table 15. Troubleshooting Matrix - Errors Displayed on Front Panel with Solution

Problem	Solution
Errors Displayed on Front Panel	
There is an error information on the LCD display	Write down the error information given on the FPI . Follow the instructions given in the RAS ticket. Power cycle the library. If you use redundant power supplies, remember to turn both switches OFF. Contact your service representative.
There is an error information on the RMI	Write down the error information given on the RMI . Follow the instructions given in the RAS ticket. Power cycle the library. If you use redundant power supplies, remember to turn both switches OFF. Contact your service representative.

Table 16. Troubleshooting Matrix - Remote Management with Solution

Problem	Solution
Remote Management	
The unit does not respond on the RMI	Verify that the Ethernet cable is connected to the correct hub. Verify that the RMI is enabled in the setup wizard via the front panel. See Operator Interfaces for details. Reboot the library by issuing a system reset. Wait at least 30 seconds for the RMI to initialize. Power cycle the library. If you use redundant power supplies, remember to turn both switches OFF. Wait at least 30 seconds for the RMI to initialize. Contact your service representative.

Table 17. Troubleshooting Matrix - Forgot Password with Solution

Problem	Solution
Forgot Password	
Forgot password on RMI	The RMI password can be cleared from the front panel interface.
Forgot password on FPI	Contact technical support. See Getting More Information or Help .

13

Shipping or Transporting the StorageLibrary

Re-inserting the Transport Locking Screws

If you need to move or ship the StorageLibrary you need to re-install the transport locking screws to protect the robotics, and in order to keep the warranty. The screws secure the robotics to the chassis and hold the robotics in a locked position during transportation. Use the instructions below to re-insert the transport locking screws.

1. Locate the transport locking screws. They are marked with red plastic tabs (four M3x6 mm screws).
2. From the [FPI](#) select **Menu > Tools > Prepare to Ship** and follow the instructions displayed on the front panel interface. The robotics will automatically be moved to the lower front position, and the magazines will pop out.
3. Remove all magazines.
4. Remove all cartridges from all the magazines.
5. Turn off the power switch on the back of the library.
6. Install the four transport locking screws. The screws secure the robotics to the front chassis. The transport locking screws are wound into the robotics from the front of the library, two on each side of the front bezel. See [Figure 43](#).
7. If installed, remove the rack mount ears. If your library is a 24 slot version you need to remove the two upper magazines by using the emergency eject tool. See [Manual/Emergency Release of Magazines](#). Re-insert all magazines.
8. If you need to ship the library, use the original packaging.

Figure 43. Transport Locking Screws Marked with Red Plastic Tab



Packing the StorageLibrary

If you want to ship the library you need to use the original packaging in order to keep the warranty. The packaging has been designed specifically for safe transportation of the StorageLibrary. See [Figure 44](#).

If you need to order new packaging contact Technical Support. For contact information, see [Getting More Information or Help](#).

Figure 44. The StorageLibrary partly packed



14

Specifications

Tandberg Data StorageLibrary T40+ Series follows the specifications described in this chapter. Table 18 lists the library components available.

Table 18. Library Specification Summary

	StorageLibrary			
	T40	T40+	T80+	T120+
Maximum Storage Slots Available	40 slots	40 slots	77 slots	114 slots
Maximum Capacity LTO3 (native/compressed)	16 / 32 TB	16 / 32 TB	30.8 / 61.6 TB	45.6 / 91.2 TB
Maximum Capacity LTO4 (native/compressed)	32 / 64 TB	32 / 64 TB	61.6 / 123.2 TB	91.2 / 182.4 TB
Maximum Drive Capacity	4	4	8	12
Maximum Number of Power Supplies	1	2	4	6
Number of Physical Libraries	1	1	2	3
Number of Logical Libraries	1	1	1	1
Supported Drive Types and Cartridges	See Approved Drive Types			
Library Robot Control	LUN			
Connectivity	Native drive interface			
Library Management	<ul style="list-style-type: none">– Remote management (web) interface– Front panel interface– SNMP protocol			

Library Dimensions

Table 19. Library Dimensions

	T40+ Dimensions
Width	445.0 mm +/- 0.5 mm (17.52" +/- 0.02")
Height	176.4 mm max (6.945")
Rear depth	770.6 mm max (30.34")
Front depth	31.0 mm max (1.22")

The rear depth is measured from the rear surface of rack mount bracket to the rearmost feature of the library.

The front depth is measured from the rear surface of the rack mount bracket to the front most feature of the library.

Library Component Weights

Table 20. Library Component Weights

Components	Weight
Drive CRU FH	3600g / 7.93 lbs
Drive CRU HH	1960g / 4.32 lbs
Power CRU	875g / 1.93 lbs
Magazine without cartridges 8 slots	1600g / 3.53 lbs
Magazine without cartridges 12 slots	1890g / 4.17 lbs
Library with 1 FH drive CRU	35kg / 77.2 lbs
Library with 2 FH drive CRUs	38kg / 83.77 lbs
Library without drive CRUs, magazines	24.5kg / 54 lbs
Library without drive CRUs, magazines, power CRU	23.55kg / 51.9 lbs

Power Requirements

Table 21. Library Power Requirements

Power Requirements	Values
Input Voltage	100 – 240 VAC
Input Frequency	50 – 60 Hz
Inrush Current (Cold Start)	Less than 15 A, 115 VAC Less than 30 A, 230 VAC
Power Consumption Average	70 W
Power Consumption Peak*	120 W*

* Maximum peak length, less than 10ms.

Climatic Specifications

Table 22. Temperature Range

Temperature		
Operating	Range	+10°C to +35°C
	Gradient	10°C/hour
Non-Operating	Range	-30°C to +60°C
	Gradient	20°C/hour

Table 23. Humidity Range

Humidity		
Operating	Range	20%Rh to 80%Rh
	Gradient	10%Rh/hour
Non-Operating	Range	10%Rh to 90%Rh
	Gradient	20%Rh /hour

Table 24. Altitude Range

Altitude		
Operating	Range	-500 to 10000 ft
Non-Operating	Range	-500 to 40000 ft

15

Safety and Regulatory Information

Safety Approvals

This product complies with the following safety standards:

Europe

EN60950-1 / A11: 2004

USA

UL60950-1: 2006, First Edition

Canada

CSA C22.2 No. 60950-1-03 1st Edition, 2006

CB report

IEC 60950-1: 2001

EMC Approvals

This product complies with the following EMC standards:

Europe

EN55022: 1998 +A1: 2000 +A2:2003, Class A

Warning: This is a class A product. In a domestic environment this product may cause radio interference in which case the user may be required to take adequate measures.

EN61000-3-2: 2000

EN61000-3-3: 1995 +A1:2001

EN55024:1998 +A1: 2001 +A2:2003

EN61000-6-2: 2001

USA

FCC: 47 CFR Part 15 Subpart B, Class A

Note: This equipment has been tested and found to comply with the limits for a Class A digital device, pursuant to Part 15 of the FCC Rules. These limits are designed to provide reasonable protection against harmful interference when the equipment is operated in a commercial environment. This equipment generates, uses, and can radiate radio frequency energy and, if not installed and used in accordance with the instruction manual, may cause harmful interference to radio communications

Operation of this equipment in a residential area is likely to cause harmful interference, in which case the user will be required to correct the interference at his/her own expense.

Japan

VCCI, Class A

この装置は、情報処理装置等電波障害自主規制協議会（VCCI）の基準に基づくクラスA情報技術装置です。この装置を家庭環境で使用すると電波妨害を引き起こすことがあります。この場合には使用者が適切な対策を講ずるよう要求されることがあります。

Translation:

This is a Class A product based on the standard of the Voluntary Control Council for Interference by Information Technology Equipment (VCCI). If this equipment is used in a domestic environment, radio interference may occur, in which case, the user may be required to take corrective actions.

Canada

ICES-003: 2004

This Class A digital apparatus complies with the Canadian ICES-003.

Cet appareil numérique de la classe A (ou classe B, si ainsi indiqué sur l'étiquette d'enregistrement) est conforme à la norme NMB-003 du Canada.

Conformity Declarations

Europe

CE

Marking by the CE symbol indicates compliance of this system to the applicable Country Directives of the European Union, including the EMC directive (2004/108/EEC) and the Low Voltage Directive (2006/95/EEC). A 'Declaration of Conformity' in accordance with the applicable directives has been issued for this product.

Australia/New Zealand

C-Tick, Class A

Marking by the C-Tick symbol indicates compliance of this system to the Australian EMC standard AS/NZS 3548: 1995: 'Information Technological Equipment'. A 'Declaration of Conformity' in accordance with the applicable standard has been issued for this product.

16

Approved Drive Types

Table 25. Approved Drive Types and Compatible Cartridges

Drive Type	LTO Generation			
	LTO4	LTO3	LTO2	LTO1
IBM LTO-4 full-height SCSI IBM LTO-4 full-height Fibre Channel IBM LTO-4 half-height SCSI IBM LTO-4 half-height SAS	Yes*	Yes*	Read only	No
IBM LTO-3 full-height SCSI IBM LTO-3 full-height Fibre Channel	No	Yes*	Yes	Read only

* LTO3 and LTO4 drives support WORM cartridges.