



RS700-E8-RS4 Series

1U Rackmount Server

User Guide



Copyright © 2014 ASUSTeK COMPUTER INC. All Rights Reserved.

No part of this manual, including the products and software described in it, may be reproduced, transmitted, transcribed, stored in a retrieval system, or translated into any language in any form or by any means, except documentation kept by the purchaser for backup purposes, without the express written permission of ASUSTeK COMPUTER INC. ("ASUS").

ASUS provides this manual "as is" without warranty of any kind, either express or implied, including but not limited to the implied warranties or conditions of merchantability or fitness for a particular purpose. In no event shall ASUS, its directors, officers, employees, or agents be liable for any indirect, special, incidental, or consequential damages (including damages for loss of profits, loss of business, loss of use or data, interruption of business and the like), even if ASUS has been advised of the possibility of such damages arising from any defect or error in this manual or product.

Specifications and information contained in this manual are furnished for informational use only, and are subject to change at any time without notice, and should not be construed as a commitment by ASUS. ASUS assumes no responsibility or liability for any errors or inaccuracies that may appear in this manual, including the products and software described in it.

Product warranty or service will not be extended if: (1) the product is repaired, modified or altered, unless such repair, modification or alteration is authorized in writing by ASUS; or (2) the serial number of the product is defaced or missing.

Products and corporate names appearing in this manual may or may not be registered trademarks or copyrights of their respective companies, and are used only for identification or explanation and to the owners' benefit, without intent to infringe.

Contents

Safety information.....	vii
About this guide.....	viii

Chapter 1: Product Introduction

1.1	System package contents.....	1-2
1.2	Serial number label.....	1-2
1.3	System specifications	1-3
1.4	Front panel features.....	1-5
1.5	Rear panel features.....	1-5
1.6	Internal features	1-6
1.7	LED information	1-7
1.7.1	Front panel LEDs.....	1-7
1.7.2	LAN (RJ-45) LEDs	1-7
1.7.3	HDD status LED.....	1-8

Chapter 2: Hardware Information

2.1	Chassis cover.....	2-2
2.2	Central Processing Unit (CPU)	2-3
2.2.1	Installing the CPU and heatsink.....	2-3
2.3	System memory	2-10
2.3.1	Overview	2-10
2.3.2	Memory Configurations.....	2-11
2.3.3	Installing a DIMM	2-13
2.3.4	Removing a DIMM	2-13
2.4	Hard disk drives	2-14
2.5	Expansion slot.....	2-16
2.5.1	Installing an expansion card to the PCIE1 slot.....	2-16
2.5.2	Installing expansion cards to the PCIE2 slot.....	2-17
2.5.3	Configuring an expansion card	2-20
2.5.4	Installing Mezzanine cards.....	2-21
2.5.5	Installing M.2 (NGFF) cards.....	2-22
2.6	Cable connections	2-23
2.7	SATA/SAS backplane cabling.....	2-24
2.8	Removable/optional components.....	2-25
2.8.1	System fans	2-25
2.8.2	Redundant power supply module.....	2-27
2.8.3	Replacing optical drive (optional).....	2-28

Contents

Chapter 3: Installation options

3.1	Tool-less Friction Rail Kit.....	3-2
-----	----------------------------------	-----

Chapter 4: Motherboard Info

4.1	Motherboard layout.....	4-2
4.2	Jumpers	4-4
4.3	Internal connectors.....	4-10
4.4	Internal LEDs.....	4-19

Chapter 5: BIOS setup

5.1	Managing and updating your BIOS	5-2
5.1.1	ASUS CrashFree BIOS 3 utility.....	5-2
5.1.2	ASUS EZ Flash Utility	5-3
5.1.3	BUPDATER utility	5-4
5.2	BIOS setup program	5-6
5.2.1	BIOS menu screen.....	5-7
5.2.2	Menu bar	5-7
5.2.3	Menu items.....	5-8
5.2.4	Submenu items	5-8
5.2.5	Navigation keys.....	5-8
5.2.6	General help.....	5-8
5.2.7	Configuration fields	5-8
5.2.8	Pop-up window.....	5-8
5.2.9	Scroll bar	5-8
5.3	Main menu	5-9
5.3.1	System Date [Day xx/xx/xxxx].....	5-9
5.3.2	System Time [xx:xx:xx]	5-9
5.4	Advanced menu	5-10
5.4.1	ACPI Settings.....	5-11
5.4.2	Smart Settings.....	5-11
5.4.3	NCT6779D Super IO Configuration	5-12
5.4.4	Onboard LAN I350 IO Configuration	5-13
5.4.5	Serial Port Console Redirection	5-14
5.4.6	APM	5-17
5.4.7	Advanced Power Management Configuration	5-18
5.4.8	PCI Subsystem Settings	5-19
5.4.9	Network Stack Configuration.....	5-20
5.4.10	CSM Configuration.....	5-21
5.4.11	Trusted Computing.....	5-22

Contents

5.4.12	USB Configuration	5-23
5.4.13	iSCSI Configuration.....	5-24
5.5	IntelRCSetup menu.....	5-25
5.5.1	Processor Configuration.....	5-26
5.5.2	Advanced Power Management Configuration.....	5-28
5.5.3	Common RefCode Configuration.....	5-28
5.5.4	QPI Configuration.....	5-29
5.5.5	Memory Configuration.....	5-30
5.5.6	IIO Configuration	5-32
5.5.7	PCH Configuration	5-33
5.5.8	Miscellaneous Configuration	5-35
5.5.9	Server ME Configuration.....	5-35
5.5.10	Runtime Error Logging Support	5-36
5.6	Server Mgmt menu.....	5-37
5.7	Event Logs menu	5-41
5.7.1	Change Smbios Event Log Settings	5-41
5.7.2	View Smbios Event Log	5-42
5.8	Monitor menu	5-43
5.9	Security menu	5-44
5.10	Boot menu	5-47
5.11	Tool menu.....	5-48
5.12	Exit menu	5-49

Chapter 6: RAID Configuration

6.1	Setting up RAID.....	6-2
6.1.1	RAID definitions	6-2
6.1.2	Installing hard disk drives.....	6-3
6.1.3	Setting the RAID item in BIOS	6-3
6.1.4	RAID configuration utilities.....	6-3
6.2	LSI Software RAID Configuration Utility	6-4
6.2.1	Creating a RAID set	6-5
6.2.2	Adding or viewing a RAID configuration.....	6-11
6.2.3	Initializing the virtual drives	6-12
6.2.4	Rebuilding failed drives.....	6-16
6.2.5	Checking the drives for data consistency.....	6-18
6.2.6	Deleting a RAID configuration.....	6-21
6.2.7	Selecting the boot drive from a RAID set.....	6-22
6.2.8	Enabling WriteCache	6-23

Contents

- 6.3 Intel® Rapid Storage Technology enterprise SATA/SSATA Option ROM Utility 6-24**
 - 6.3.1 Creating a RAID set 6-25
 - 6.3.2 Deleting a RAID set..... 6-27
 - 6.3.3 Resetting disks to Non-RAID 6-28
 - 6.3.4 Exiting the Intel® Rapid Storage Technology enterprise SATA/SSATA Option ROM utility..... 6-29
 - 6.3.5 Rebuilding the RAID..... 6-29
 - 6.3.6 Setting the Boot array in the BIOS Setup Utility..... 6-31
- 6.4 Intel® Rapid Storage Technology enterprise (Windows)..... 6-32**
 - 6.4.1 Creating a RAID set 6-33
 - 6.4.2 Changing a Volume Type..... 6-35
 - 6.4.3 Deleting a volume 6-36
 - 6.4.4 Preferences..... 6-37

Chapter 7: Driver installation

- 7.1 RAID driver installation 7-2**
 - 7.1.1 Creating a RAID driver disk..... 7-2
 - 7.1.2 Installing the RAID controller driver..... 7-3
- 7.2 Management applications and utilities 7-13**
 - installation 7-13**
- 7.3 Running the Support DVD 7-13**
- 7.4 Intel® chipset device software installation 7-17**
- 7.5 Installing the Intel® I350-AM1/I350-AM2/I210 X540-BT2 Gigabit Adapters driver 7-19**
- 7.6 VGA driver installation 7-22**
- 7.7 Intel® Rapid Storage Technology enterprise 4.0 7-24**
 - installation 7-24**

Appendix A: Reference Information

- Z10PP-D24 block diagram A-2**
- Notices A-3**
 - Federal Communications Commission Statement..... A-3
 - Canadian Department of Communications Statement..... A-4
 - REACH A-4
 - ASUS Recycling/Takeback Services A-4
 - Australia statement notice..... A-4
- ASUS contact information..... A-5**

Safety information

Electrical Safety

- Before installing or removing signal cables, ensure that the power cables for the system unit and all attached devices are unplugged.
- To prevent electrical shock hazard, disconnect the power cable from the electrical outlet before relocating the system.
- When adding or removing any additional devices to or from the system, ensure that the power cables for the devices are unplugged before the signal cables are connected. If possible, disconnect all power cables from the existing system before you add a device.
- If the power supply is broken, do not try to fix it by yourself. Contact a qualified service technician or your dealer.

Operation Safety

- Any mechanical operation on this server must be conducted by certified or experienced engineers.
- Before operating the server, carefully read all the manuals included with the server package.
- Before using the server, ensure all cables are correctly connected and the power cables are not damaged. If any damage is detected, contact your dealer as soon as possible.
- To avoid short circuits, keep paper clips, screws, and staples away from connectors, slots, sockets and circuitry.
- Avoid dust, humidity, and temperature extremes. Place the server on a stable surface.
- If you encounter technical problems with the product, contact a qualified service technician or your retailer.



This product is equipped with a three-wire power cable and plug for the user's safety. Use the power cable with a properly grounded electrical outlet to avoid electrical shock.

Lithium-Ion Battery Warning

CAUTION! Danger of explosion if battery is incorrectly replaced. Replace only with the same or equivalent type recommended by the manufacturer. Dispose of used batteries according to the manufacturer's instructions.

CD-ROM Drive Safety Warning

CLASS 1 LASER PRODUCT

Heavy System

CAUTION! This server system is heavy. Ask for assistance when moving or carrying the system.

About this guide

Audience

This user guide is intended for system integrators, and experienced users with at least basic knowledge of configuring a server.

Contents

This guide contains the following parts:

1. Chapter 1: Product introduction

This chapter describes the general features of the server, including sections on front panel and rear panel specifications.

2. Chapter 2: Hardware setup

This chapter lists the hardware setup procedures that you have to perform when installing or removing system components.

3. Chapter 3: Installation options

This chapter describes how to install optional components into the barebone server.

4. Chapter 4: Motherboard information

This chapter gives information about the motherboard that comes with the server. This chapter includes the motherboard layout, jumper settings, and connector locations.

5. Chapter 5: BIOS setup

This chapter tells how to change system settings through the BIOS Setup menus and describes the BIOS parameters.

6. Chapter 6: RAID configuration

This chapter tells how to change system settings through the BIOS Setup menus. Detailed descriptions of the BIOS parameters are also provided.

7. Chapter 7: Driver installation

This chapter provides instructions for installing the necessary drivers for different system components.

Conventions

To ensure that you perform certain tasks properly, take note of the following symbols used throughout this manual.



DANGER/WARNING: Information to prevent injury to yourself when trying to complete a task.



CAUTION: Information to prevent damage to the components when trying to complete a task.



IMPORTANT: Instructions that you **MUST** follow to complete a task.



NOTE: Tips and additional information to help you complete a task.

Typography

Bold text

Indicates a menu or an item to select.

Italics

Used to emphasize a word or a phrase.

<Key>

Keys enclosed in the less-than and greater-than sign means that you must press the enclosed key.

Example: <Enter> means that you must press the Enter or Return key.

<Key1>+<Key2>+<Key3>

If you must press two or more keys simultaneously, the key names are linked with a plus sign (+).

Example: <Ctrl>+<Alt>+<D>

Command

Means that you must type the command exactly as shown, then supply the required item or value enclosed in brackets.

Example: At the DOS prompt, type the command line: **format A:/S**

References

Refer to the following sources for additional information, and for product and software updates.

1. **ASUS Server Web-based Management (ASWM) user guide**

This manual tells how to set up and use the proprietary ASUS server management utility.

2. **ASUS websites**

The ASUS websites worldwide provide updated information for all ASUS hardware and software products. Refer to the ASUS contact information.

Product introduction

1

This chapter describes the general features of the chassis kit. It includes sections on front panel and rear panel specifications.

1.1 System package contents

Check your system package for the following items.

Model Name	RS700-E8-RS4; RS700-E8-RS4-C
Chassis	ASUS R12D 1U Rackmount Chassis
Motherboard	ASUS Z10PP-D24 Server Board
Component	1 x 800W 80PLUS Platinum Power Supply
	1 x SAS 3.5-inch HDD Backplane
	4 x hot-swap 3.5-inch HDD trays
	1 x Front I/O Board
	2 x Riser Card
Accessories	8 x System Fans (40 mm x 40 mm x 56 mm)
	1 x RS700-E8-RS4 Support CD
	1 x ASWM* Enterprise Support CD
	1 x ASMB Support CD
	1 x Bag of Screws
	2 x CPU Heatsink
Optional Items	2 x AC Power Cable
	1 x Redundant 800W 80PLUS Platinum Power Supply (Second PSU)
	1 x Friction Rail Kit
	1 x Slim type DVD-RW

*ASUS System Web-based Management



If any of the above items is damaged or missing, contact your retailer.

1.2 Serial number label

The product's serial number contains 14 characters such as xxS0xxxxxxxx and printed on the server's Asset tag.

The correct serial number of the product is required if you need to request for support from the ASUS Technical Support team.



1.3 System specifications

The ASUS RS700-E8-RS4 Series feature the ASUS Z10PP-D24 server board. The server supports Intel® Socket-R3 LGA2011-3 Xeon® series processors plus other latest technologies through the chipsets onboard.

Model Name	RS700-E8-RS4	RS700-E8-RS4-C
Processor / System Bus	2 x Socket R3 (LGA 2011-3) Intel® Xeon® processor E5-2600 v3 product family QPI 6.4 / 8.0 / 9.6 GT/s	
Core Logic	Intel® C612 chipset	
ASUS Features	Smart Fan	√
	ASWM Enterprise	√
Memory	Total Slots	24 (4-channel per CPU, 12 DIMM per CPU)
	Capacity	Maximum up to 1536 GB
	Memory Type	DDR4 2133/1866/1600/1333 RDIMM/LR-DIMM/NVDIMM
	Memory Size	32 GB, 16 GB, 8 GB, 4 GB (RDIMM) / 64 GB, 32 GB (LRDIMM) * Refer to ASUS server AVL for the latest update
Expansion Slots	Total PCI/PCI-X / PCI-E Slots	3
	Slot Type	1 x PCI-E x16 (Gen3 x16 link), FH, HL 1 x PCI-E x8 (Gen3 x8 link), LP, HL 1 x PCI-E x8 (Gen3 x8 link), proprietary* 1 x PCI-E x8 (Gen3 x8 link), OCP Mezzanine** * Support for ASUS PIKE II (optional) ** Support for MCB-10G-2S (Dual Port 10 Gigabit/s Ethernet card) (optional)
	SATA Controller	Intel® C612 - 2 x MiniSAS ports (4 x SATA ports) + 2 x SATA ports or 2 x MiniSAS ports (4 x SATA ports) + 1 x SATA port + 1 x M.2 connector
Disk Controller	SAS Controller	Intel® RSTe (for Windows only; Support software RAID 0, 1, 10, & 5) Optional: ASUS PIKE II 3008 8-port SAS HBA card ASUS PIKE II 3108 8-port SAS HW RAID card
	Storage Bays	I = internal A or S will be hot-swappable 4 x Hot-swap 3.5-inch HDD Bays
Networking	LAN	1 x Dual Port Intel I350-AM2 Gigabit LAN controller 1 x Management Port
Graphic	VGA	Aspeed AST2400 32 MB

(continued on the next page)

Model Name		RS700-E8-RS4	RS700-E8-RS4-C
Auxiliary Storage Device Bay (Floppy / Optical Drive)		1 x Slim-type Optical Drive Bay Options: No Device / DVD-RW	
I/O connector, Switches, and LEDs		Rear I/O Connector and Switch/LED: 2 x USB 3.0 ports 1 x VGA port 2 x RJ-45 GbE LAN port 1 x RJ-45 Management LAN 1 x PS/2 KB/Mouse port 1 x Power switch/LED	
OS Support		Windows® Server 2012 R2 Windows® Server 2012 Windows® Server 2008 R2 Windows® 8.1 RedHat® Enterprise Linux SuSE® Linux Enterprise Server CentOS Ubuntu VMware Citrix XenServer * Refer to http://www.asus.com/ for the latest OS support.	
Management Solution	Out of Band Remote Hardware	On-Board ASMB8-iKVM for KVM-over-IP	
	Software	ASUS ASWM Enterprise	
Dimension (HH x WW x DD)		686 mm x 444 mm x 44 mm (1U)	
Net Weight Kg (CPU, DRAM & HDD not included)		18 Kg	
Power Supply		1+1 800W 80PLUS Platinum Redundant Power Supply	1+1 550W 80PLUS Gold Redundant Power Supply
Power Rating		100-127Vac/ 200-240Vac, 9.9A/4.79A, 47-63Hz, Class I	100-127Vac / 200-240Vac, 7A/3.4A, 47-63Hz, Class I
Environment		Operation temperature: 10°C ~ 35°C Non operation temperature: -40°C ~ 70°C Non operation humidity: 20% ~ 90% (Non condensing)	

*Specifications are subject to change without notice.

1.4 Front panel features

The barebone server displays a simple yet stylish front panel with easily accessible features. The power and reset buttons, LED indicators, slim type optical drive, and two USB ports are located on the front panel.



Refer to the **Front panel LEDs** section for the LED descriptions.

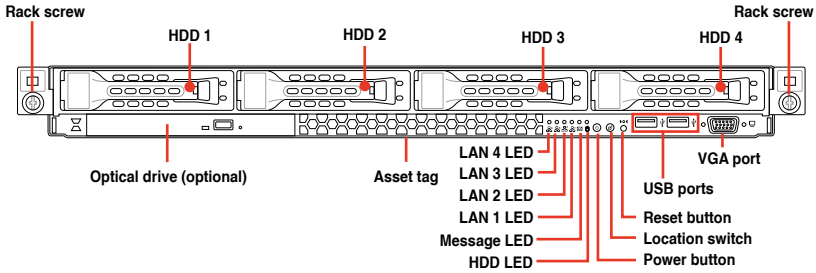

1.5 Rear panel features

The rear panel includes the expansion slots, system power socket, and rear fans. The middle part includes the I/O shield with openings for the rear panel connectors on the motherboard.

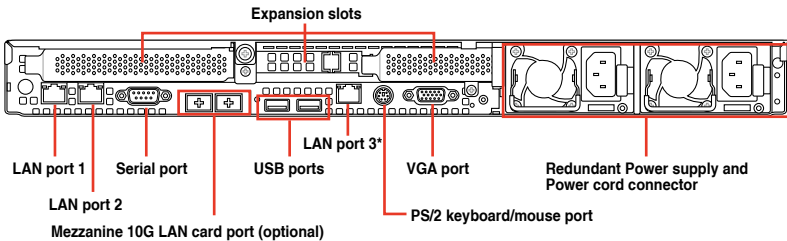

*This port is for ASUS ASMB8-iKVM only.

1.6 Internal features

The barebone server includes the basic components as shown.

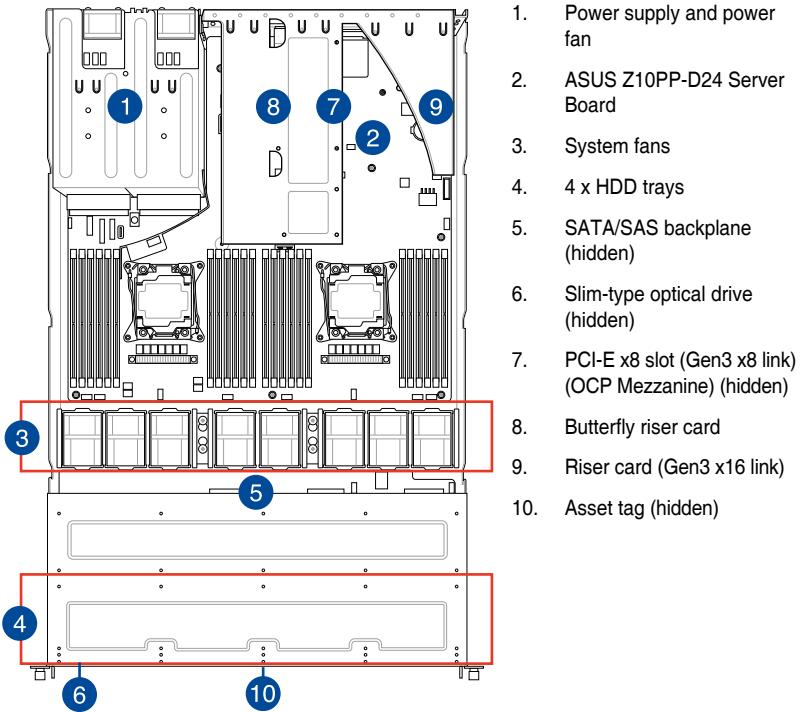

The barebone server does not include a floppy disk drive. Connect a USB floppy disk drive to any of the USB ports on the front or rear panel if you need to use a floppy disk.



A protection film is pre-attached to the front cover before shipping. Please remove the protection film before turning on the system for proper heat dissipation.

WARNING
HAZARDOUS MOVING PARTS
KEEP FINGERS AND OTHER BODY PARTS AWAY

1.7 LED information

1.7.1 Front panel LEDs

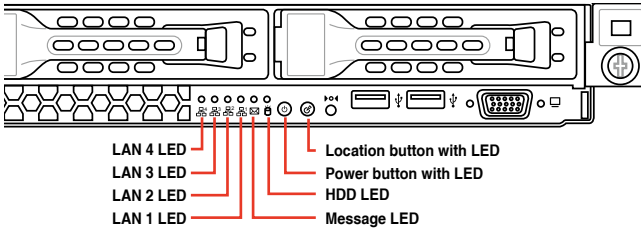

LED	Icon	Display status	Description
Power LED		ON	System power ON
HDD Access LED		OFF Blinking	No activity Read/write data into the HDD
Message LED		OFF ON	System is normal; no incoming event A hardware monitor event is indicated
Location LED		OFF ON	Normal status Location switch is pressed (Press the location switch again to turn off)
LAN LEDs		OFF Blinking ON	No LAN connection LAN is transmitting or receiving data LAN connection is present

1.7.2 LAN (RJ-45) LEDs

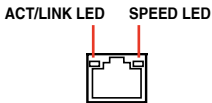

ACT/LINK LED		SPEED LED	
Status	Description	Status	Description
OFF	No link	OFF	10 Mbps connection
GREEN	Linked	ORANGE	100 Mbps connection
BLINKING	Data activity	GREEN	1 Gbps connection

1.7.3 HDD status LED

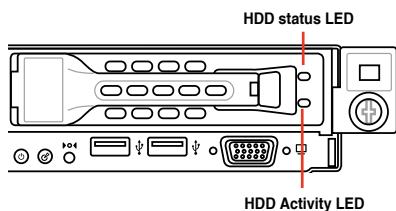

SATA/SAS HDD LED Description			
HDD Status LED	GREEN	ON	SATA/SAS HDD power ON
	RED	ON	HDD has failed and should be swapped immediately
	GREEN/ RED	Blinking	RAID rebuilding
	GREEN/ RED	OFF	HDD not found
HDD Activity LED	GREEN	Blinking	Read/write data from/into the SATA/SAS HDD

Hardware Information

2

This chapter lists the hardware setup procedures that you have to perform when installing or removing system components.

2.1 Chassis cover

Removing the rear cover

To remove the rear cover:

1. Loosen the thumbscrew on the rear panel to release the rear cover from the chassis.

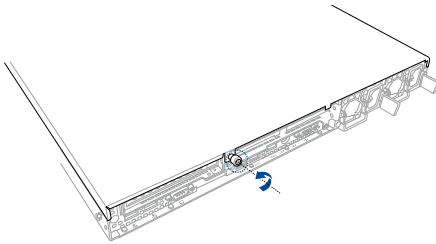

2. Firmly hold the cover and slide it toward the rear panel for about half an inch until it is disengaged from the chassis.
3. Lift the cover from the chassis.

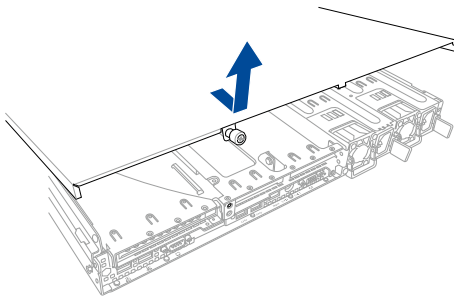

2.2 Central Processing Unit (CPU)

The motherboard comes with a surface mount LGA 2011-3 socket designed for the Intel® Xeon E5-2600 V3 family processor.



- Upon purchase of the motherboard, ensure that the PnP cap is on the socket and the socket contacts are not bent. Contact your retailer immediately if the PnP cap is missing, or if you see any damage to the PnP cap/socket contacts/motherboard components. ASUS will shoulder the cost of repair only if the damage is shipment/transit-related.
- Keep the cap after installing the motherboard. ASUS will process Return Merchandise Authorization (RMA) requests only if the motherboard comes with the cap on the LGA 2011-3 socket.
- The product warranty does not cover damage to the socket contacts resulting from incorrect CPU installation/removal, or misplacement/loss/incorrect removal of the PnP cap.

2.2.1 Installing the CPU and heatsink

To install a CPU:

1. Remove the rear cover. For more information, see the section **Chassis cover**.
2. Remove the air duct.

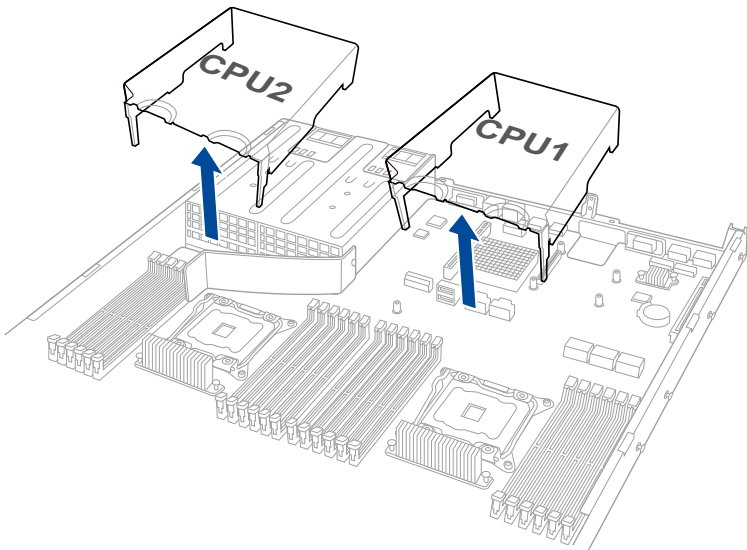

3. Locate the CPU socket on the motherboard.

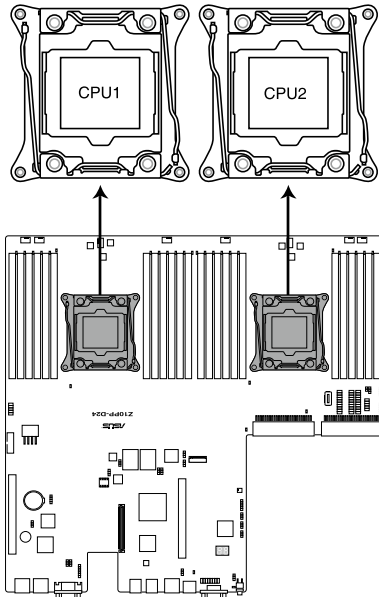

Z10PP-D24 CPU LGA2011-3 Socket



Before installing the CPU, ensure that the socket box is facing toward you and the triangle mark is on the top-right position.

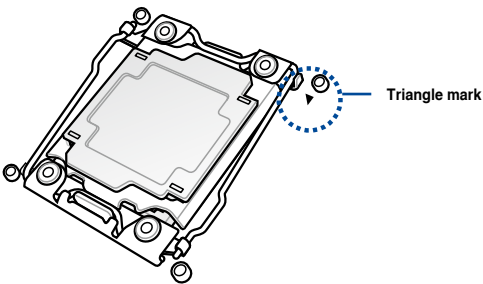

4. Press down the load lever with your thumb (A), move it to the right until it is released from the retention tab (B), then gently lift the load lever (C).



To prevent damage to the socket pins, do not remove the PnP cap unless you are installing a CPU.

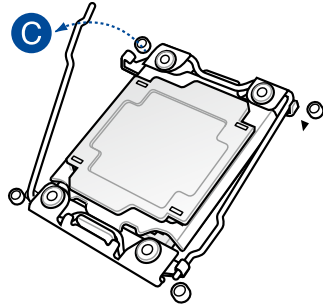
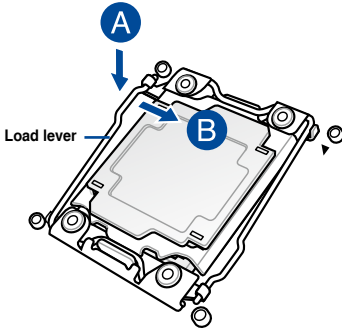

5. Press down the right load lever with your thumb (D), move it to the left until it is released from retention tab (E), then gently lift the load lever (F).

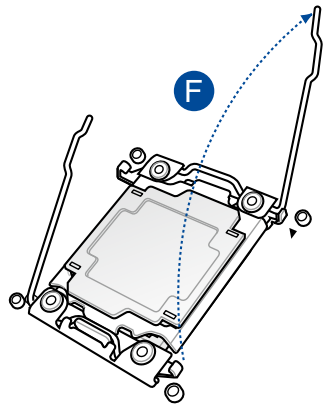
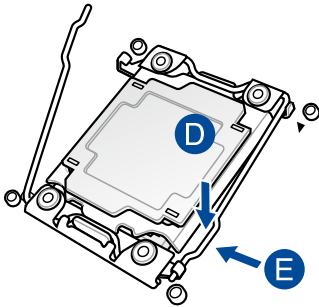

6. Push the left load lever to slightly lift the load plate (G).



Do not insert the load lever into the retention tab.

7. Hold the edge then gently lift the load plate (H).

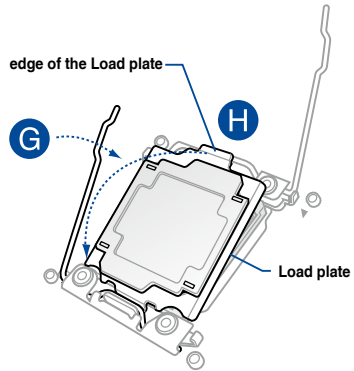

8. Get the CPU.
9. Align and position the CPU over the socket ensuring that the triangle mark on the CPU matches the triangle mark on the socket box.
10. Install the CPU into the slot.



The CPU fits in only one correct orientation. DO NOT force the CPU into the socket to prevent bending the CPU pins on the socket.

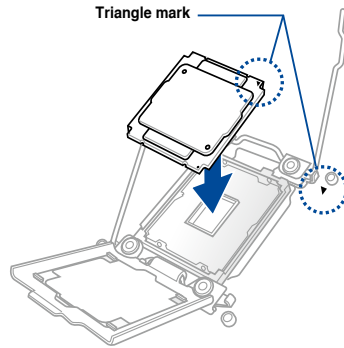

11. Gently push the load plate just enough to let it sit on top of the CPU.



Do not force to close the load plate as it may damage the CPU.

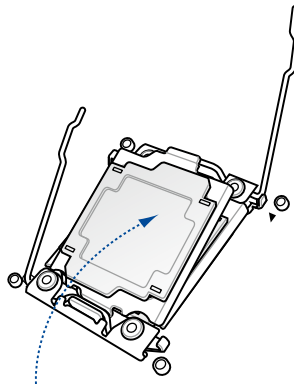

12. Push down the right load lever (I) ensuring that the edge of the load plate is fixed and tucked securely under the lever (J) then insert the right load lever under the retention tab (K).



The PnP cap pops out of the load plate when the right load lever is inserted into the retention tab.



Keep the PnP cap. ASUS will process Return Merchandise Authorization (RMA) requests only if the motherboard comes with the PnP cap on the LGA 2011 socket.

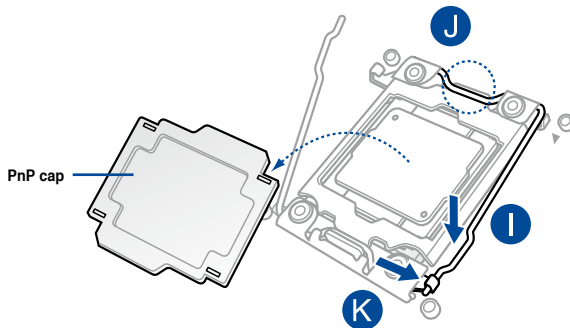

13. Push down the left load lever (L) then insert it under the retention tab (M).

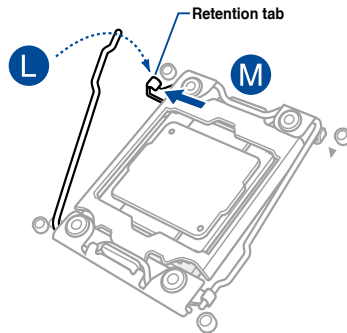

14. Apply some Thermal Interface Material to the exposed area of the CPU that the heatsink will be in contact with.



- Ensure that the Thermal Interface Material is spread in an even thin layer.
- Some heatsinks come with pre-applied Thermal Interface Material. If so, skip this step.

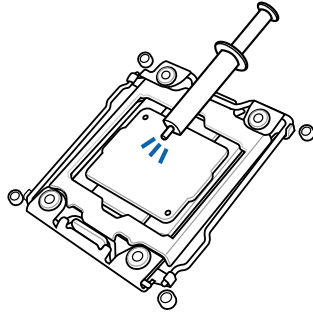

The Thermal Interface Material is toxic and inedible. DO NOT eat it. If it gets into your eyes or touches your skin, wash it off immediately, and seek professional medical help.

15. Prepare the CPU heatsink.
16. Place the heatsink on top of the installed CPU ensuring that the four fasteners matches the holes on the motherboard.
17. Twist each of the four screws with a Philips (cross) screwdriver just enough to attach the heatsink to the motherboard. When the four screws are attached, tighten them one by one in a diagonal sequence to completely secure the heatsink.

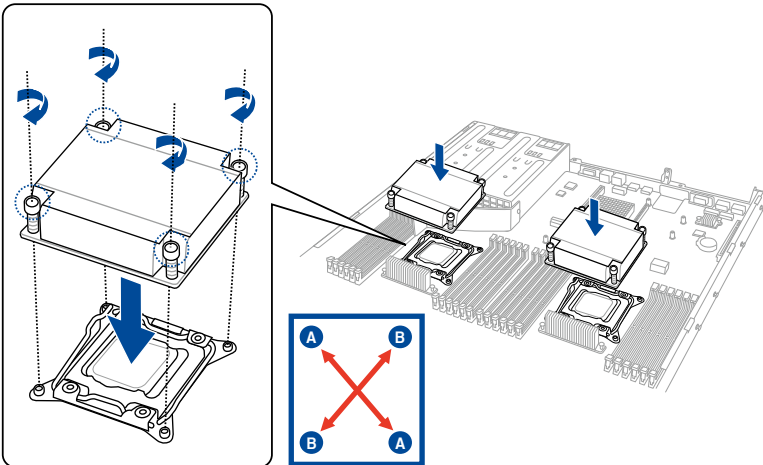

18. Replace the air duct.

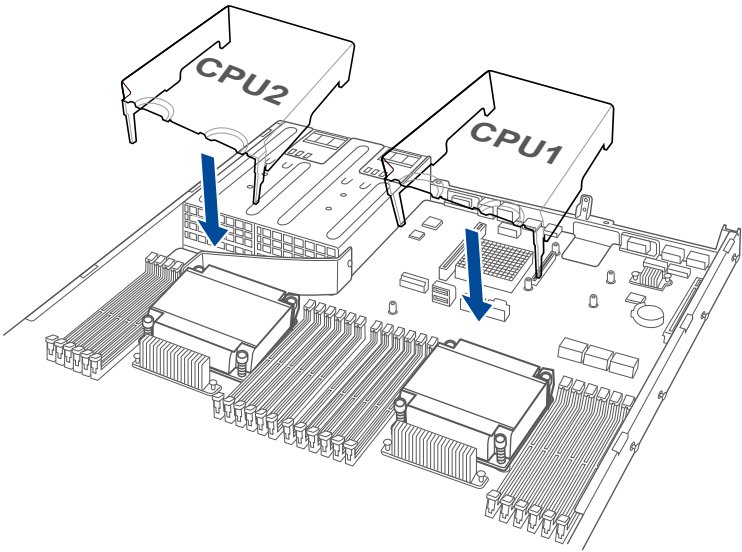

2.3 System memory

2.3.1 Overview

The motherboard comes with 24 Double Data Rate 4 (DDR4) Dual Inline Memory Modules (DIMM) sockets.

The figure illustrates the location of the DDR4 DIMM sockets:

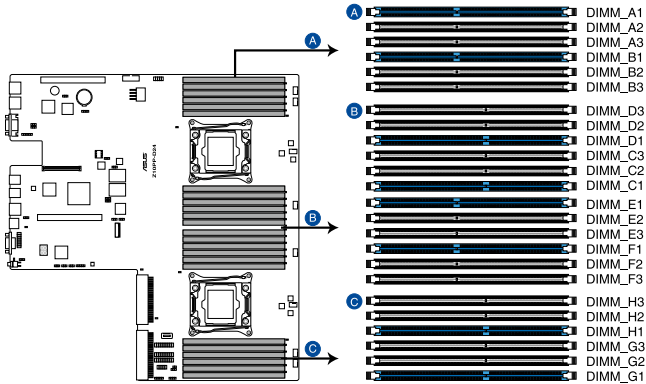

Z10PP-D24 288-pin DDR4 DIMM sockets

2.3.2 Memory Configurations

You may install 4 GB, 8 GB, 16 GB, and 32 GB RDIMMs or 32 GB, 64 GB LR-DIMMs and NVDIMM into the DIMM sockets using the memory configurations in this section.



- Refer to ASUS Server AVL for the updated list of compatible DIMMs.
- When installing only one DIMM in a single CPU configuration, install the DIMM on either A1 or B1.
- Always install DIMMs with the same CAS latency. For optimum compatibility, it is recommended that you obtain memory modules from the same vendor.

1 CPU Configuration (must on CPU1)						
	DIMM_A3	DIMM_A2	DIMM_A1	DIMM_B3	DIMM_B2	DIMM_B1
1 DIMM			•			
2 DIMMs			•			•
4 DIMMs			•			•
8 DIMMs		•	•		•	•
12 DIMMs	•	•	•	•	•	•

1 CPU Configuration (must on CPU1)						
	DIMM_C3	DIMM_C2	DIMM_C1	DIMM_D3	DIMM_D2	DIMM_D1
1 DIMM						
2 DIMMs						
4 DIMMs			•			•
8 DIMMs		•	•		•	•
12 DIMMs	•	•	•	•	•	•

2 CPU Configuration						
	DIMM_A3	DIMM_A2	DIMM_A1	DIMM_B3	DIMM_B2	DIMM_B1
2 DIMMs			•			
4 DIMMs			•			•
8 DIMMs			•			•
12 DIMMs		•	•		•	•
16 DIMMs		•	•		•	•
20 DIMMs	•	•	•	•	•	•
24 DIMMs	•	•	•	•	•	•

2 CPU Configuration						
	DIMM_C3	DIMM_C2	DIMM_C1	DIMM_D3	DIMM_D2	DIMM_D1
2 DIMMs						
4 DIMMs						
8 DIMMs			•			•
12 DIMMs			•			•
16 DIMMs		•	•		•	•
20 DIMMs		•	•		•	•
24 DIMMs	•	•	•	•	•	•

2 CPU Configuration						
	DIMM_E3	DIMM_E2	DIMM_E1	DIMM_F3	DIMM_F2	DIMM_F1
2 DIMMs			•			
4 DIMMs			•			•
8 DIMMs			•			•
12 DIMMs		•	•		•	•
16 DIMMs		•	•		•	•
20 DIMMs	•	•	•	•	•	•
24 DIMMs	•	•	•	•	•	•

2 CPU Configuration						
	DIMM_G3	DIMM_G2	DIMM_G1	DIMM_H3	DIMM_H2	DIMM_H1
2 DIMMs						
4 DIMMs						
8 DIMMs			•			•
12 DIMMs			•			•
16 DIMMs		•	•		•	•
20 DIMMs		•	•		•	•
24 DIMMs	•	•	•	•	•	•

2.3.3 Installing a DIMM



Ensure to unplug the power supply before adding or removing DIMMs or other system components. Failure to do so may cause severe damage to both the motherboard and the components.

1. Unlock a DIMM socket by pressing the retaining clips outward.
2. Align a DIMM on the socket such that the notch on the DIMM matches the DIMM slot key on the socket.

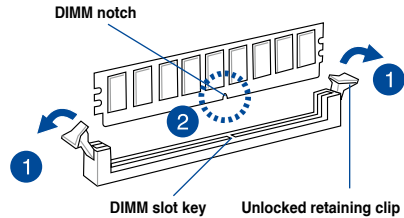

A DIMM is keyed with a notch so that it fits in only one direction. **DO NOT** force a DIMM into a socket in the wrong direction to avoid damaging the DIMM.

3. Hold the DIMM by both of its ends then insert the DIMM vertically into the socket. Apply force to both ends of the DIMM simultaneously until the retaining clips snaps back into place.

Ensure that the DIMM is sitting firmly on the DIMM slot.

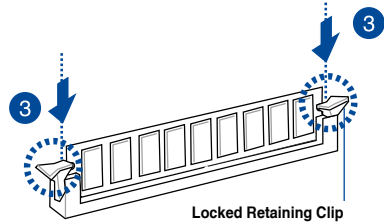

Always insert the DIMM into the socket **VERTICALLY** to prevent DIMM notch damage.

2.3.4 Removing a DIMM

1. Simultaneously press the retaining clips outward to unlock the DIMM.
2. Remove the DIMM from the socket.

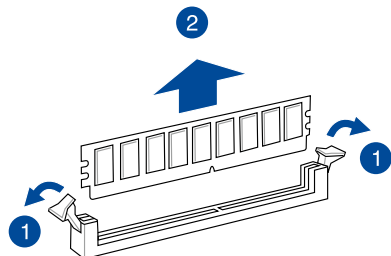

Support the DIMM lightly with your fingers when pressing the retaining clips. The DIMM might get damaged when it flips out with extra force.

2.4 Hard disk drives

The system supports four hot-swap SATA/SAS hard disk drives. The hard disk drive installed on the drive tray connects to the motherboard SATA/SAS ports via the SATA/SAS backplane.

To install a hot-swap SATA/SAS HDD:

1. Push the spring lock to the right (A) then pull the tray lever outward (B) to release the drive tray. The drive tray ejects slightly after you pull out the lever.

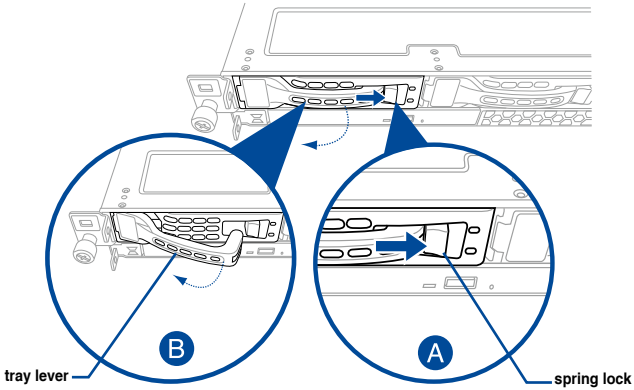

2. Firmly hold the tray lever and pull the drive tray out of the bay.

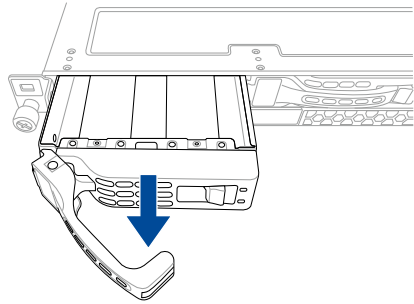

3. Place the drive tray on a flat and stable surface.
4. Prepare the SATA/SAS HDD and the bundled set of screws.

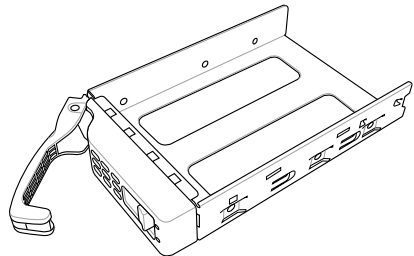

5. Place the SATA/SAS HDD into the tray then secure it with four screws.

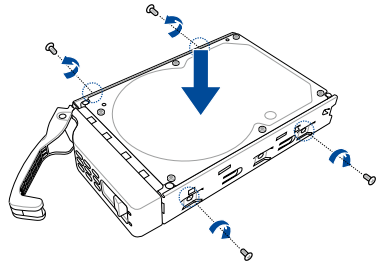

6. Insert the drive tray and HDD assembly all the way into the depth of the bay until just a small fraction of the tray edge protrudes.

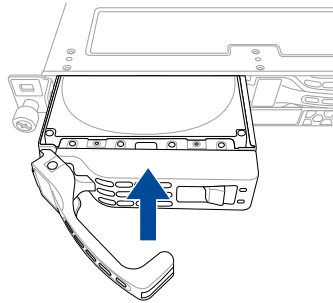

When installed, the SATA/SAS connector on the drive connects to the SATA/SAS interface on the backplane.

7. Push the tray lever until it clicks and secures the drive tray in place.



The drive tray is correctly placed when its front edge aligns with the bay edge.

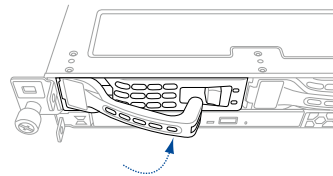

8. Repeat steps 1 to 7 to install the other SATA/SAS HDDs.

2.5 Expansion slot

The barebone server comes with two PCIe slots - PCIe1 and PCIe2. These slots are pre-installed with a riser card bracket and a butterfly riser card bracket for installing PCIe expansion cards. You need to remove these expansion card brackets if you want to install PCIe expansion cards.

2.5.1 Installing an expansion card to the PCIe1 slot

The pre-installed riser card bracket on the PCIe1 slot supports Full-Height (FH), Half-Length (HL) PCIe x16 expansion cards.

To install a PCIe x16 (Gen3 x16 link), FH, HL card on the riser card bracket:

1. Firmly hold the riser card bracket then pull it up to detach it from the PCIe x16 slot on the motherboard.

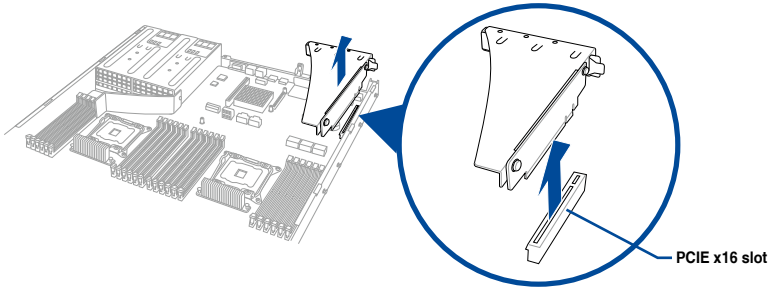

2. Remove the screw from the metal cover (A) then remove the metal cover (B) from riser card bracket.

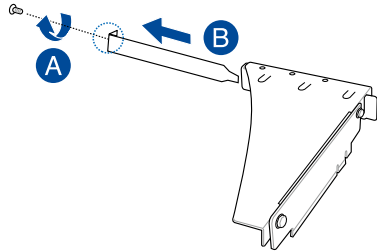

3. Get the PCIe expansion card.
4. Install the PCIe expansion card to the riser card bracket (A) then secure the expansion card with a screw (B).

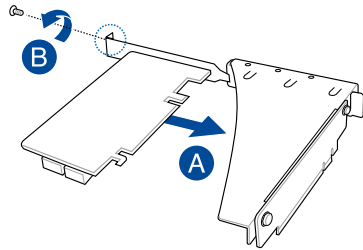

5. Install the riser card bracket and the PCIe expansion card assembly into the PCIe connector on the motherboard. Ensure that the golden connectors of the riser card bracket is firmly seated in place.

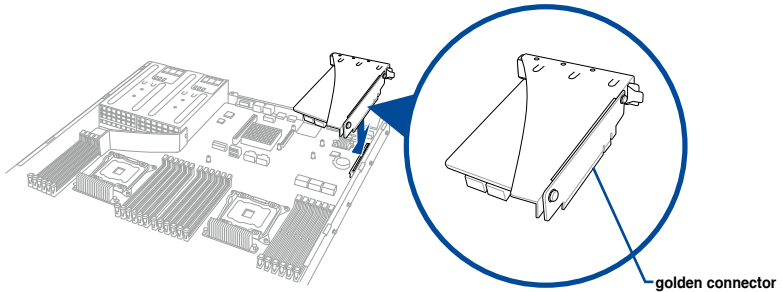

2.5.2 Installing expansion cards to the PCIe2 slot

The pre-installed butterfly card bracket on the PCIe2 slot has one PCIe x8 slot and one PCIe x16 slot. Although the PCIe x16 slot is physically longer than the PCIe x8 slot, both of these slots provides x8 Gen3 links.



The PCIe x8 slot supports proprietary cards such as ASUS PIKE II series cards. Install your proprietary cards into this slot to maximize its use.

To install a PCI-E x8 (Gen3 x8 link), proprietary card to the PCIe x8 slot:

1. Remove the three screws that secure the butterfly riser card bracket to the chassis.
2. Carefully remove the butterfly riser card bracket.

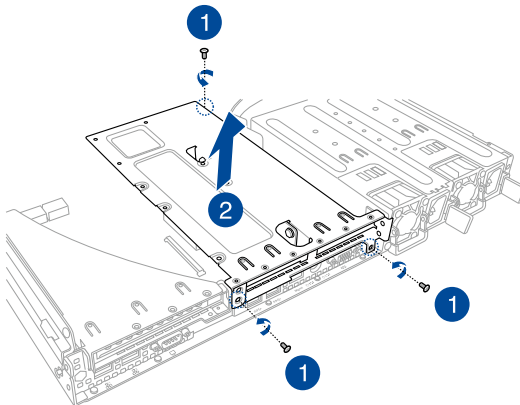

- Place the butterfly riser card on a flat and stable surface.
- Remove the metal cover then set it aside.



The default metal cover on the PCIe x8 slot of the butterfly riser card is an ASUS proprietary card bracket. It is screwless by design allowing for easy installation or removal.

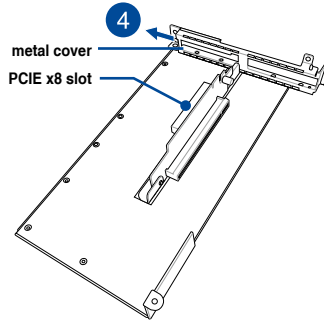

- Prepare the PCIe x8 expansion card.



If your expansion card is pre-installed with a proprietary card bracket, proceed to step 9.

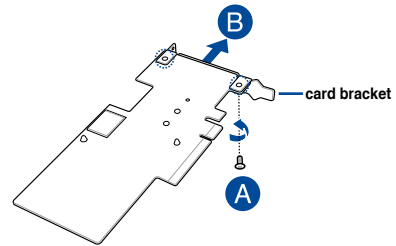

- Remove the two screws on the expansion card (A) then remove the card bracket (B).

- Get the metal cover (proprietary card bracket) that you removed earlier in step 4.

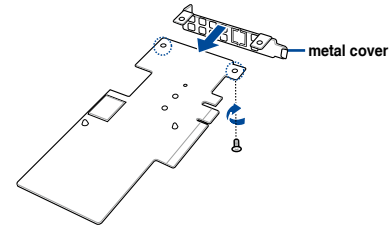

- Secure the expansion card and the metal cover with two screws.

- Install the expansion card and the metal cover assembly to the PCIe x8 slot as shown.

Ensure that the metal cover is inserted and firmly seated in place.

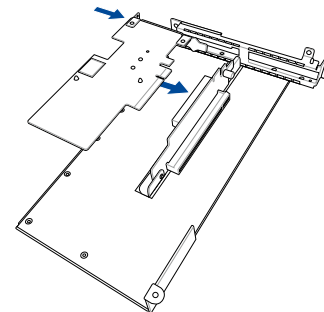

To install a PCI-E x8 (Gen3 x8 link), LP, HL card to the PCIE x16 slot:

1. Place the butterfly riser card on a flat and stable surface.
2. Remove the screw (A) from the metal cover then remove the metal cover (B).

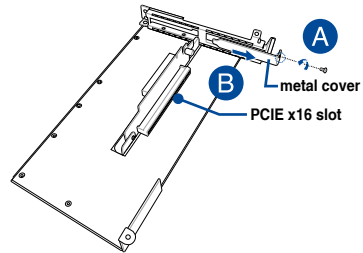

3. Install the expansion card to PCIE x16 slot.
4. Secure the expansion card with a screw.

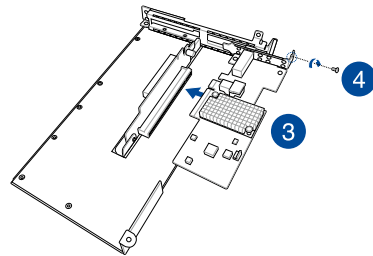

Replacing the butterfly riser card bracket

To replace or install the butterfly riser card bracket:

1. Align and place the butterfly riser card bracket into the chassis as shown.



Ensure that the screw holes on the riser card bracket matches the screw holes on the chassis.

2. Secure the riser card bracket with three screws as shown.

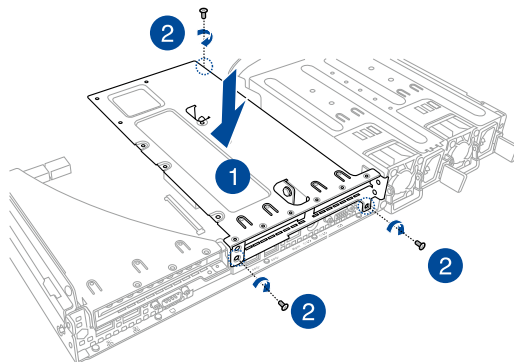

2.5.3 Configuring an expansion card

After installing the expansion card, configure it by adjusting the software settings.

1. Turn on the system and change the necessary BIOS settings, if any. See Chapter 5 for information on BIOS setup.
2. Assign an IRQ to the card. Refer to the following tables.
3. Install the software drivers for the expansion card.

Standard Interrupt assignments

IRQ	Priority	Standard function
0	1	System Timer
1	2	Keyboard Controller
2	-	Programmable Interrupt
3*	11	Communications Port (COM2)
4*	12	Communications Port (COM1)
5*	13	--
6	14	Floppy Disk Controller
7*	15	--
8	3	System CMOS/Real Time Clock
9*	4	ACPI Mode when used
10*	5	IRQ Holder for PCI Steering
11*	6	IRQ Holder for PCI Steering
12*	7	PS/2 Compatible Mouse Port
13	8	Numeric Data Processor
14*	9	Primary IDE Channel
15*	10	Secondary IDE Channel

* These IRQs are usually available for ISA or PCI devices.

2.5.4 Installing Mezzanine cards

To install a Mezzanine card:

1. Locate the Mezzanine card connector on your motherboard.

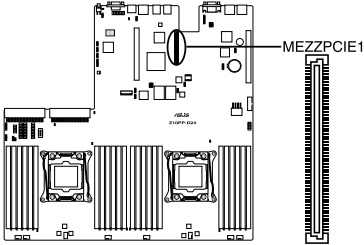

2. Prepare the Mezzanine card.
3. Insert the port of the Mezzanine card into the mounting hole on the chassis then insert the golden connector of the Mezzanine card into the OCP connector on the motherboard.

Ensure that the stand screws on the motherboard is aligned and matched with the screw holes of the Mezzanine card.

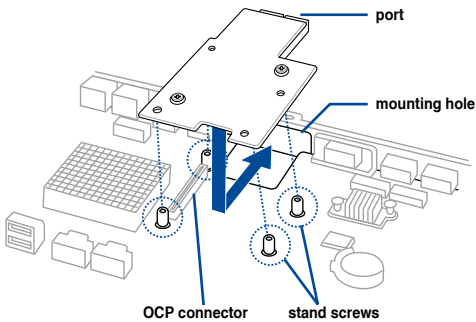

4. Secure the Mezzanine card with four bundled screws.

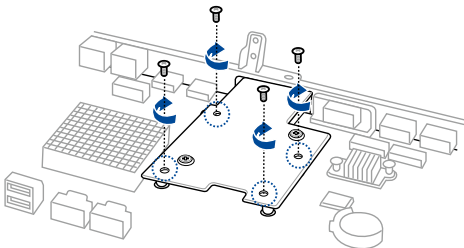

2.5.5 Installing M.2 (NGFF) cards

To install an M.2 (NGFF) card:

1. Locate the M.2 (NGFF) connector on your motherboard.

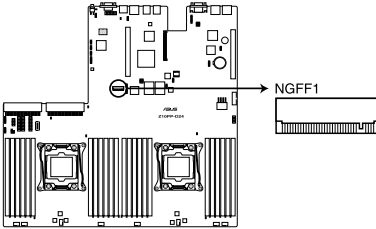

Z10PP-D24 NGFF1 connector

2. Prepare the M.2 card.
3. Remove the screw on the stand
4. Align and insert the M.2 card into the M.2 connector on the motherboard.

Ensure that the golden connector of the M.2 card is inserted firmly in place and that the screw hole on the M.2 card matches the stand screw on the motherboard.

5. Secure the M.2 card with a screw.

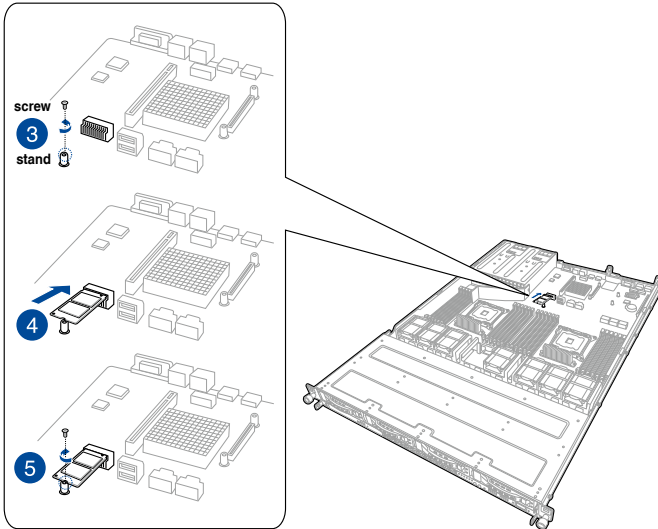

- Please pay attention when removing the screw, the stand screw might be removed together with it.
- Ensure that the M.2 card is positioned between the screw and the stand screw before securing it.

2.6 Cable connections



- The bundled system cables are pre-connected before shipment. You do not need to disconnect these cables unless you will remove pre-installed components to install additional devices.
- Refer to Chapter 4 for detailed information on the connectors.

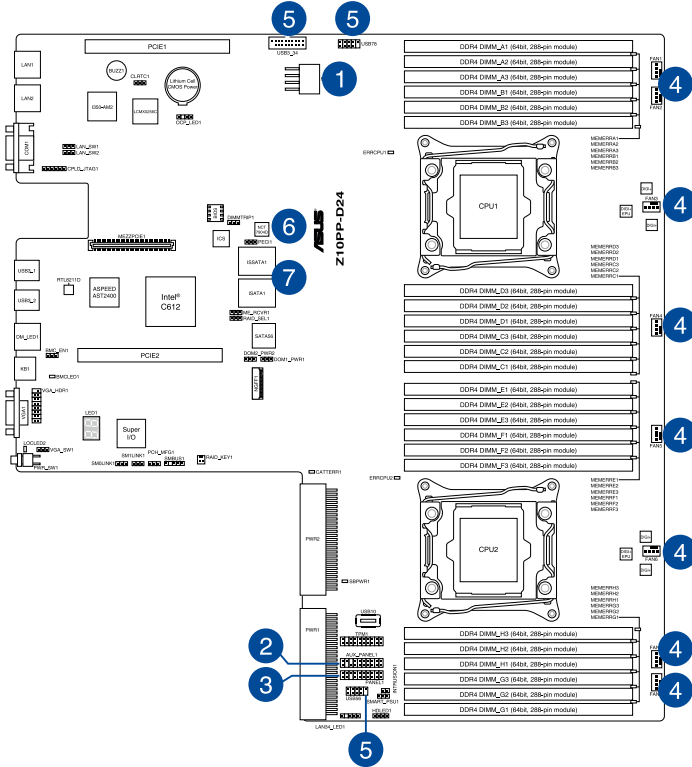

Pre-connected system cables

1. 8-pin BPPWR1 power connector (from power supply to backplane)
2. Auxiliary panel connector (from motherboard to front I/O board)
3. Panel connector (from motherboard to front I/O board)
4. System fan connectors (from motherboard FAN1-8 to system fans)
5. USB connectors (from motherboard to front I/O board)
6. SATA connector (from motherboard to SATA/SAS backplane board to connect ODD)
7. ISATA connector (from motherboard to SATA/SAS backplane board to connect HDD 1 - HDD 4)

2.7 SATA/SAS backplane cabling

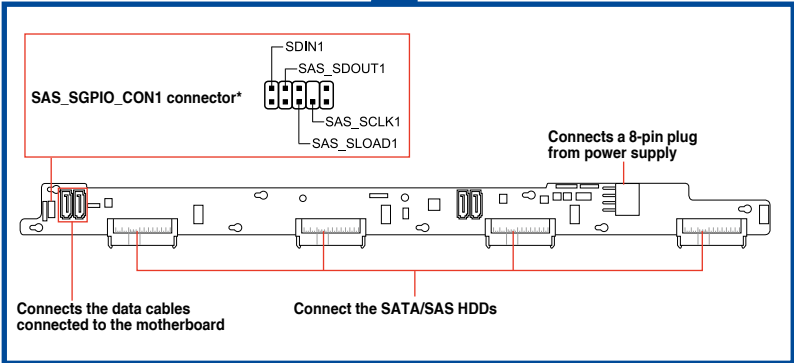
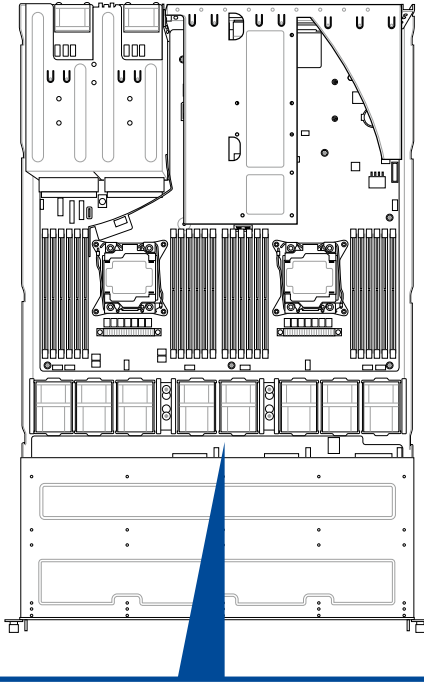

* For PIKE RAID solution, ensure to connect SAS_SGPIIO_CON1 to support PIKE card SAS RAID function.

2.8 Removable/optional components

This section explains how to install optional components into the system and covers the following components:

1. System fans
2. Redundant power supply module
3. Slim type optical drive (optional)



Ensure that the system is turned off before removing any components.



You may need to remove previously installed component or factory shipped components when installing optional components.

2.8.1 System fans

To uninstall the system fans:

1. Disconnect the system fan cable from the fan connector on the motherboard.
2. Lift the fan, then set aside.
3. Repeat steps 1 to 2 to uninstall the other system fans.

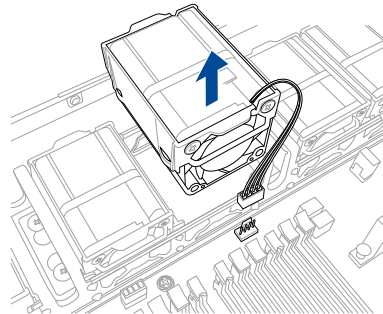
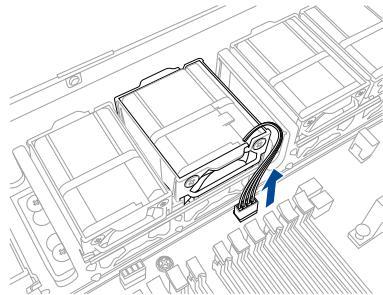

To reinstall the system fans:

1. Insert the fan to the fan cage. The airflow directional arrow on the fan side should point towards the system rear panel.

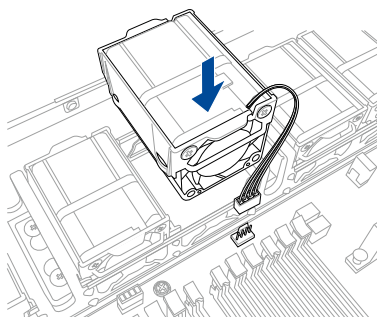

2. Connect the system fan cable to the fan connector on the motherboard.

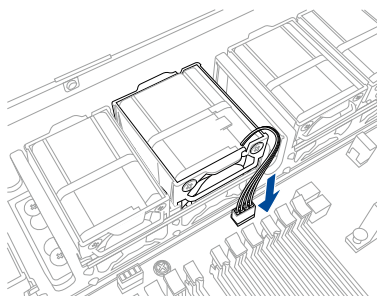

2.8.2 Redundant power supply module

To replace a failed redundant power supply module:

1. Lift up the power supply module lever.

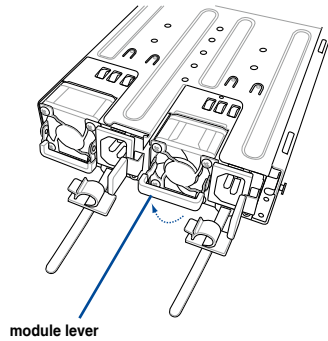

2. Hold the power supply module lever and press the PSU latch (A) then pull the power supply module (B) out of the system chassis.

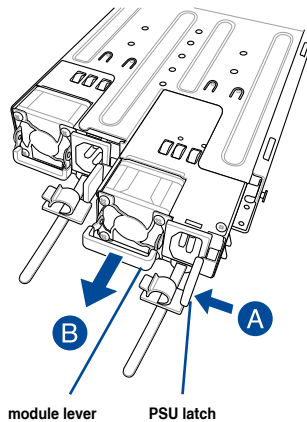

3. Get the replacement power supply module.
4. Insert the replacement power supply module into the chassis then push it inwards until the latch locks into place.

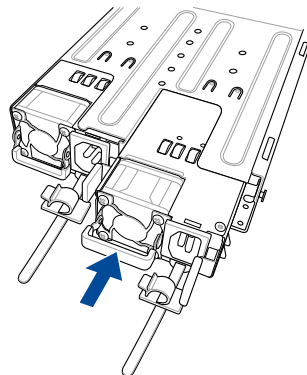

2.8.3 Replacing optical drive (optional)

This server system supports a slim-type optical disk drive.

To replace the optical disk drive:

1. Remove the screw that secures the optical drive. Set aside.
2. Push the spring lock to the right (A) to remove the SATA/SAS drive tray then pull the tray lever outward (B).
The drive tray ejects slightly after you pull out the lever (C).
3. Hold the tray lever and pull the drive tray out of the bay.
4. Pull the optical drive module.
5. Carefully insert the replacement optical disk drive module into the drive bay until it is securely seated in place.
6. Carefully insert the drive tray and push it all the way to the depth of the bay until just a small fraction of the tray edge protrudes.
7. Push the tray lever until it clicks, and secures the drive tray in place. The drive tray is correctly placed when its front edge aligns with the bay edge.
8. Secure the optical drive with the screw that you removed in step 1.

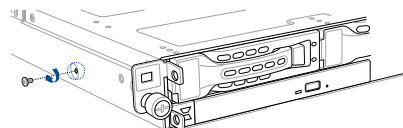
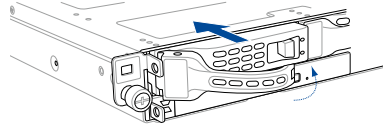
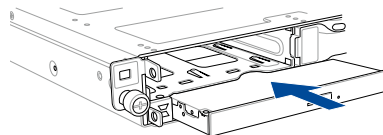
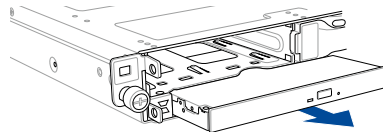
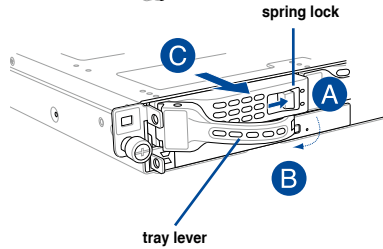
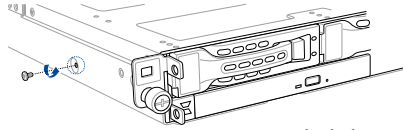

Installation options

3

This chapter describes how to install the optional components and devices into the barebone server.

3.1 Tool-less Friction Rail Kit

The tool less design of the rail kit allows you to easily install the rack rails into the server rack without the need for additional tools. The kit also comes with a metal stopping bracket that can be installed to provide additional support and stability to the server.

The tool-less rail kit package includes:

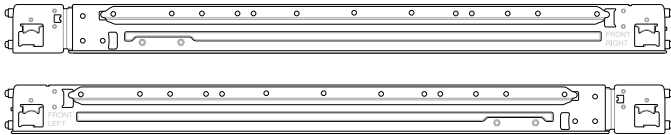
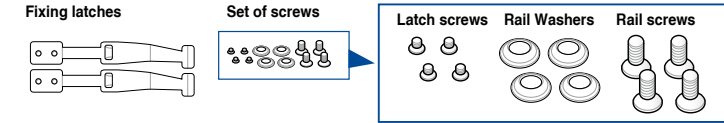

Installing the tool-less rack rail

To install the tool-less rack rails into the rack:

1. Secure the two fixing latches to the two sides of the server using the set of latch screws.



The locations of the screw holes vary with different server models. Refer to your server user manual for details.

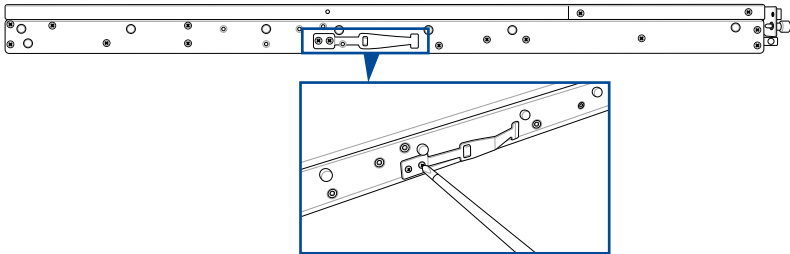

2. Select a desired space and place the appropriate rack rail (left and right) on opposite positions on the rack.



A 1U space is consists of three square mounting holes with two thin lips on the top and the bottom.

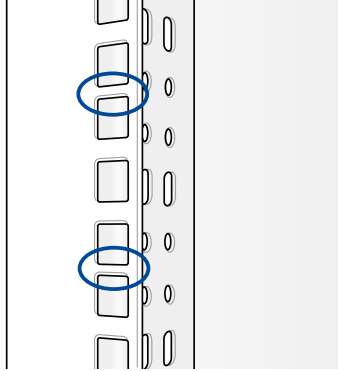

3. Press the spring lock then insert the studs into the selected square mounting holes on the rack post.
4. Press the spring lock on the other end of rail then insert the stud into the mounting hole on the rack post. Extend the rack rail, if necessary.
5. Perform steps 3 to 4 for the other rack rail.



Ensure that the installed rack rails (left and right) are aligned, secured, and stable in place.

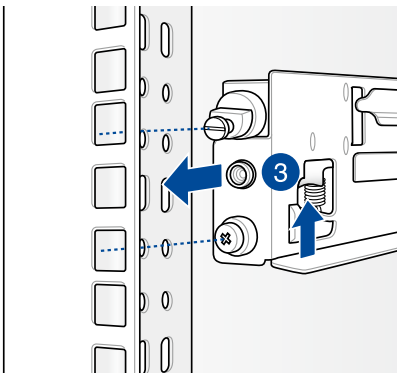

6. Lift the server chassis and insert into the rack rail.

-
- Ensure that the rack rail cabinet and the rack posts are stable and standing firmly on a level surface.
 - We strongly recommend that at least two able-bodied persons perform the steps described in this guide.
 - We recommend the use of an appropriate lifting tool or device, if necessary.
-

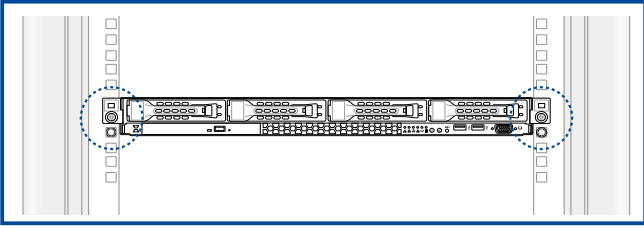

Ensure to include the side knots on the two sides of the server in the rack rail holders.



The illustrations shown above are for reference only.

Motherboard Info

This chapter includes the motherboard layout and brief descriptions of the jumpers and internal connectors.

4

4.1 Motherboard layout

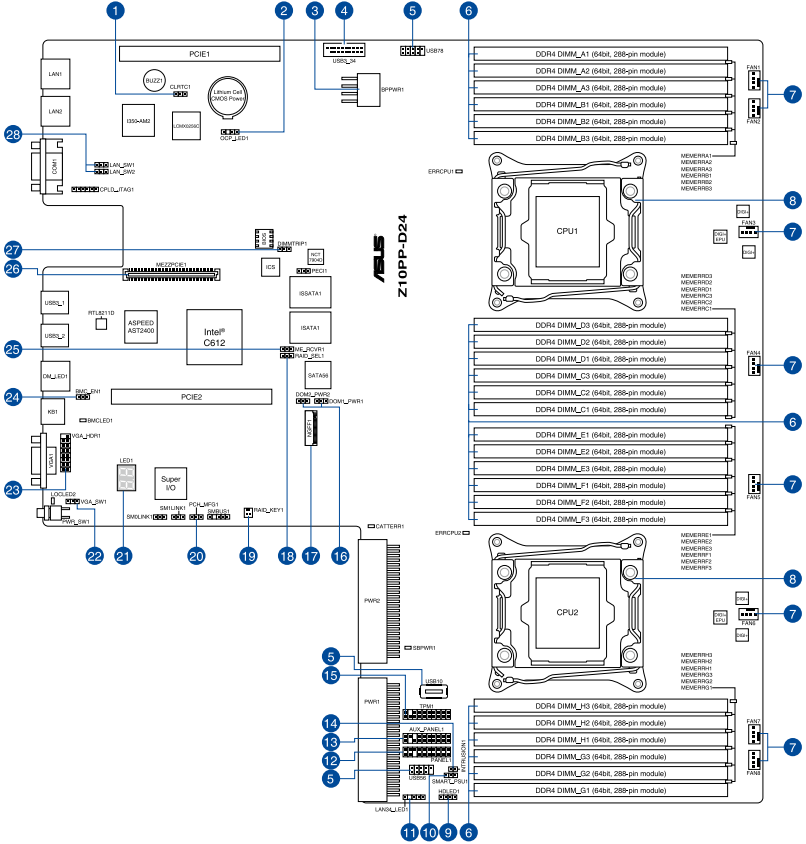

Layout contents

Internal connectors / Sockets / Jumpers / LEDs		Page
1	Clear RTC RAM (CLRTC1)	4-4
2	OCPLAN Activity LED connector (4-pin OCP_LED1)	4-21
3	Power connectors (8-pin BPPWR1)	4-16
4	USB 3.0 connectors (20-1 pin USB3_34)	4-11
5	USB 2.0 connectors (10-1 pin USB56, USB78, Type A USB10)	4-10
6	DDR4 DIMM sockets	2-10
7	System fan connectors (4-pin FAN1-8)	4-13
8	CPU socket	2-4
9	Hard disk activity LED connector (4-pin HDLED1)	4-12
10	Smart Ride Through (SmaRT) setting (3-pin SMART_PSU1)	4-8
11	LAN Activity LED connector (5-1 pin LAN34_LED1)	4-11
12	System panel connector (20-pin PANEL1)	4-14
13	Auxiliary panel connector (20-2 pin AUX_PANEL1)	4-15
14	Chassis Intrusion (2-pin INTRUSION1)	4-18
15	TPM connector (20-1 pin TPM1)	4-13
16	SATA DOM power setting (3-pin DOM1_PWR1, DOM2_PWR2)	4-8
17	M.2 (NGFF) card connector (NGFF1)	4-17
18	RAID configuration utility selection (3-pin RAID_SEL1)	4-6
19	RAID key connector (2-pin RAID_KEY1)	4-18
20	PCH_MFG1 setting (3-pin PCH_MFG1)	4-9
21	Q-Code LEDs (LED1)	4-22
22	VGA controller setting (3-pin VGA_SW1)	4-5
23	VGA connector (10-1 pin VGA_HDR1)	4-16
24	Baseboard Management Controller setting (3-pin BMC_EN1)	4-7
25	ME firmware force recovery setting (3-pin ME_RCVR1)	4-6
26	Mezzanine PCI card connector (MEZZPCIE1)	4-16
27	DDR4 thermal event setting (3-pin DIMMTRIP1)	4-7
28	LAN controller setting (3-pin LAN_SW1, LAN_SW2)	4-5

4.2 Jumpers

1. Clear RTC RAM (CLRRTC1)

This jumper allows you to clear the Real Time Clock (RTC) RAM in CMOS. You can clear the CMOS memory of date, time, and system setup parameters by erasing the CMOS RTC RAM data. The onboard button cell battery powers the RAM data in CMOS, which include system setup information such as system passwords.

To erase the RTC RAM:

1. Turn OFF the computer and unplug the power cord.
2. Move the jumper cap from pins 1–2 (default) to pins 2–3. Keep the cap on pins 2–3 for about 5–10 seconds, then move the cap back to pins 1–2.
3. Plug the power cord and turn ON the computer.
4. Hold down the key during the boot process and enter BIOS setup to re-enter data.



Except when clearing the RTC RAM, never remove the cap on CLRRTC jumper default position. Removing the cap will cause system boot failure!



If the steps above do not help, remove the onboard battery and move the jumper again to clear the CMOS RTC RAM data. After the CMOS clearance, reinstall the battery.

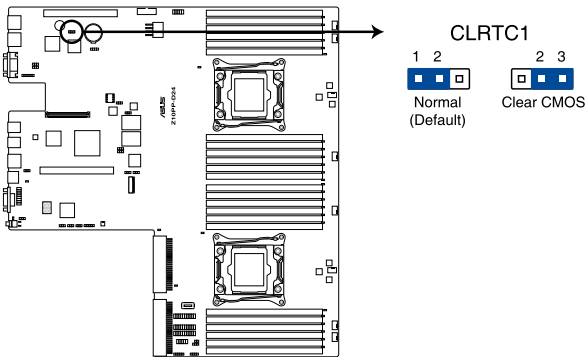

Z10PP-D24 Clear RTC RAM

2. VGA controller setting (3-pin VGA_SW1)

This jumper allows you to enable or disable the onboard VGA controller. Set to pins 1–2 to activate the VGA feature.

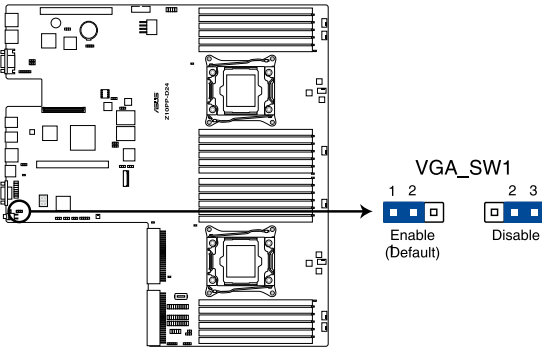

Z10PP-D24 VGA setting

3. LAN controller setting (3-pin LAN_SW1, LAN_SW2)

These jumpers allow you to enable or disable the onboard Intel® I350-AM2 Gigabit LAN1/2 controller. Set to pins 1–2 to activate the Gigabit LAN feature.

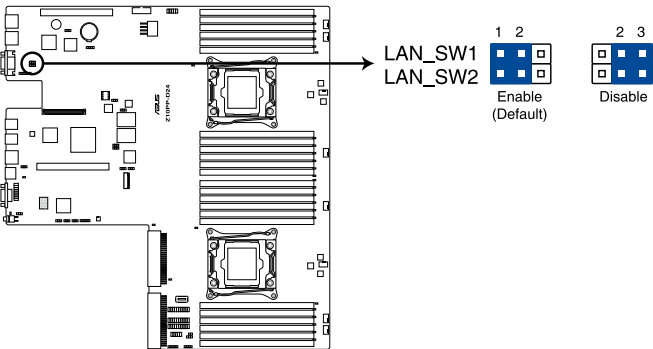

Z10PP-D24 LAN setting

4. RAID configuration utility selection (3-pin RAID_SEL1)

This jumper allows you to select the RAID configuration utility to use when you create disk arrays. Place the jumper caps over pins 1–2 if you want to use the LSI MegaRAID software RAID Setup Utility (default); otherwise, place the jumper caps to pins 2–3 to use the Intel® Rapid Storage Technology Enterprise.

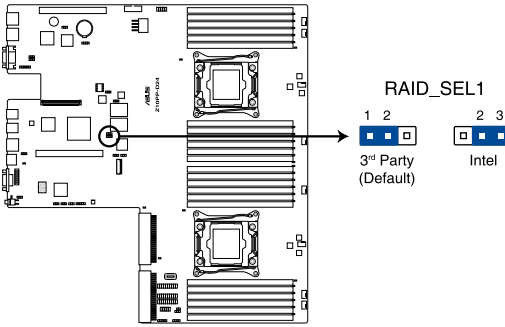

Z10PP-D24 RAID setting

5. ME firmware force recovery setting (3-pin ME_RCVR1)

This jumper allows you to quickly recover the Intel Management Engine (ME) firmware when it becomes corrupted.

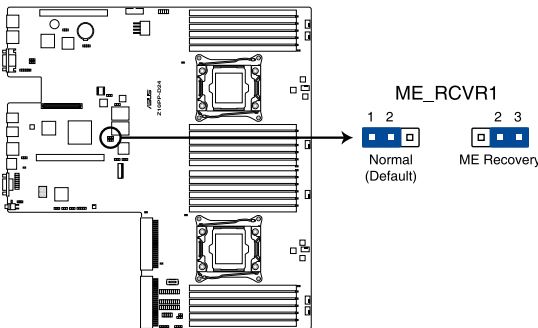

Z10PP-D24 ME recovery setting

6. Baseboard Management Controller setting (3-pin BMC_EN1)

This jumper allows you to enable (default) or disable on-board BMC.

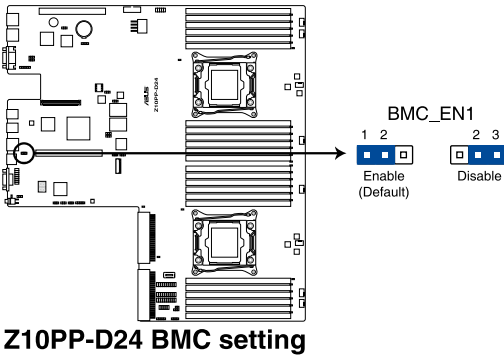

7. DDR4 thermal event setting (3-pin DIMMTRIP1)

This jumper allows you to enable or disable DDR4 DIMM thermal sensing event pin.

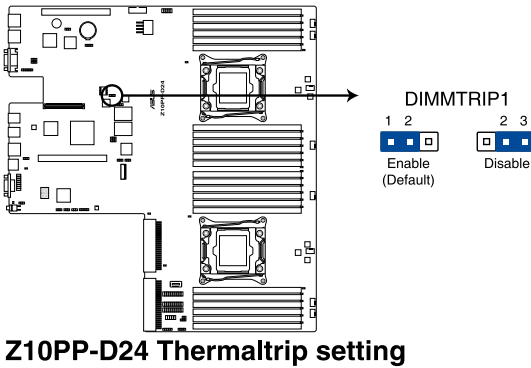

8. Smart Ride Through (SmaRT) setting (3-pin SMART_PSU1)

This jumper allows you to enable or disable the Smart Ride Through (SmaRT) function. This feature is disabled by default. Set to pins 1-2 to enable it. When enabled, SmaRT allows uninterrupted operation of the system during an AC loss event.

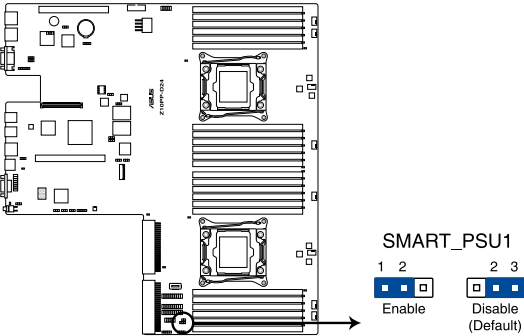

Z10PP-D24 Smart Ride Through (SmaRT) setting

9. SATA DOM power setting (3-pin DOM1_PWR1, DOM2_PWR2)

This jumper allows you to configure the DOM power setting.

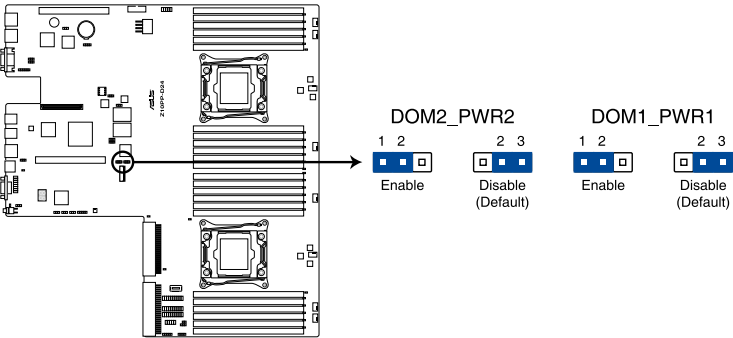

Z10PP-D24 DOM PWR setting

10. PCH_MFG1 setting (3-pin PCH_MFG1)

This jumper allows you to update the BIOS ME block select.

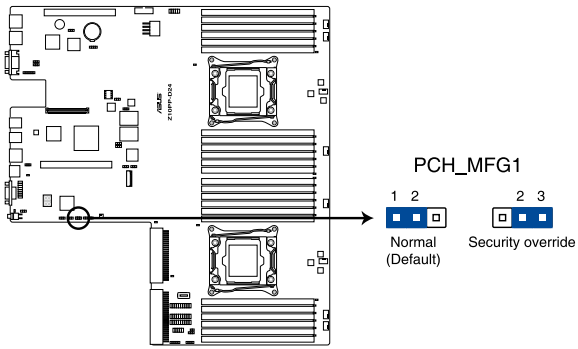

Z10PP-D24 PCH_MFG setting

4.3 Internal connectors

1. Serial ATA connectors (7-pin SATA1-2 [Blue])

These connectors, controlled by Intel® C612 chipset, are for the Serial ATA signal cables for Serial ATA hard disk drives (SATA 5 connector for optical drive use by default).



If the M.2 slot is occupied, the SATA6G_6 slot will be disabled.

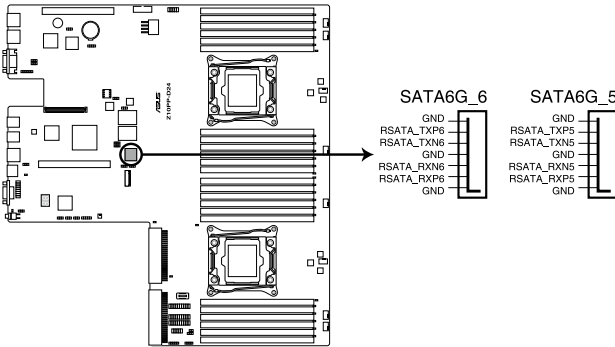

Z10PP-D24 SATA connectors

2. USB 2.0 connectors (10-1 pin USB56, USB78, Type A USB10)

The USB56 and USB78 connectors are for USB 2.0 ports. Connect the USB module cable to the connectors, and then install the module to a slot opening at the back of the system chassis. The USB10 connector is for a A-type internal USB 2.0 device. The USB connectors comply with USB 2.0 specification that supports up to 480 Mbps connection speed.

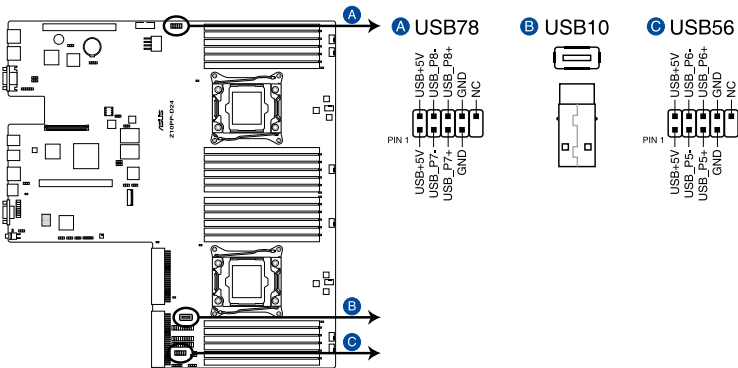

Z10PP-D24 USB 2.0 connectors



The USB port module is purchased separately.

3. USB 3.0 connectors (20-1 pin USB3_34)

This connector allows you to connect a USB 3.0 module for additional USB 3.0 front or rear panel ports. With an installed USB 3.0 module, you can enjoy all the benefits of USB 3.0 including faster data transfer speeds of up to 5Gbps, faster charging time for USB-chargable devices, optimized power efficiency, and backward compatibility with USB 2.0.

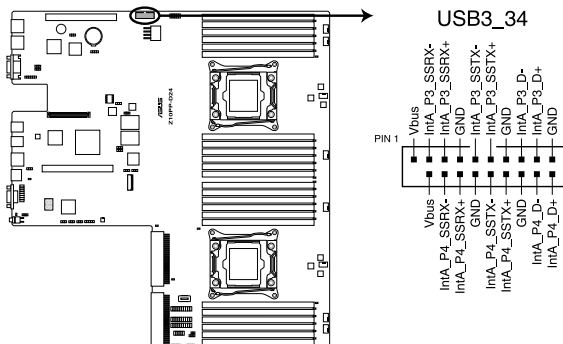

Z10PP-D24 USB 3.0 connector

4. LAN Activity LED connector (5-1 pin LAN34_LED1)

These leads are for 10G LAN activity LEDs on the front panel. Connect the LAN LED cable to the backplane for LAN activity indication.

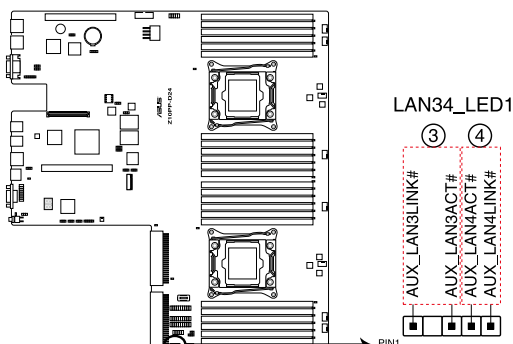

Z10PP-D24 LAN3 & LAN4 LED

5. ISATA and ISSATA connectors (ISATA, ISSATA)

The ISATA connector (AHCI) supports 4 SATA 6Gb/s ports and Intel RAID/LSI MegaRAID.

The ISSATA connector (AHCI) supports 4 SATA 6Gb/s ports and Intel RAID.

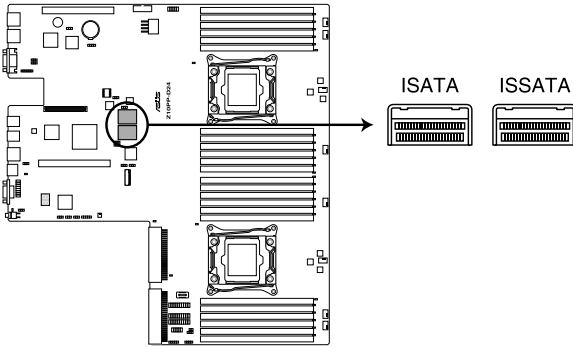

Z10PP-D24 ISATA & ISSATA connector

6. Hard disk activity LED connector (4-pin HDLED1)

This connector is used to connect to a hard disk drive active LED connector on the SCSI or RAID card.

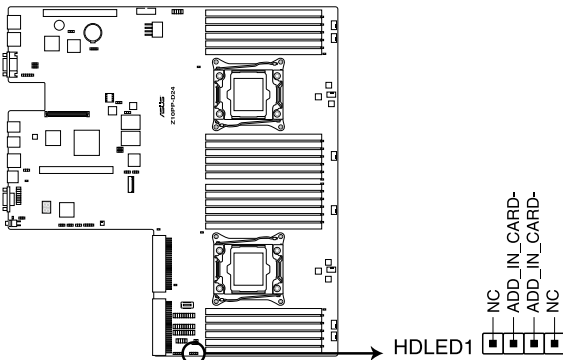

Z10PP-D24 Hard disk activity LED connector

7. System fan connectors (4-pin FAN1-8)

The fan connectors support cooling fans of 0.8A–1.0A (12 W max.) or a total of 6.4 A–8.0 A (96 W max.) at +12V. Connect the fan cables to the fan connectors on the motherboard, making sure that the black wire of each cable matches the ground pin of the connector.



DO NOT forget to connect the fan cables to the fan connectors. Insufficient air flow inside the system may damage the motherboard components. These are not jumpers! DO NOT place jumper caps on the fan connectors!

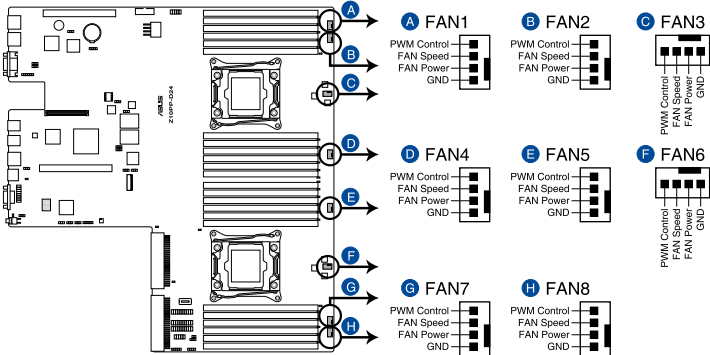

8. TPM connector (20-pin TPM1)

This connector supports a Trusted Platform Module (TPM) system, which can securely store keys, digital certificates, passwords, and data. A TPM system also helps enhance network security, protects digital identities, and ensures platform integrity.

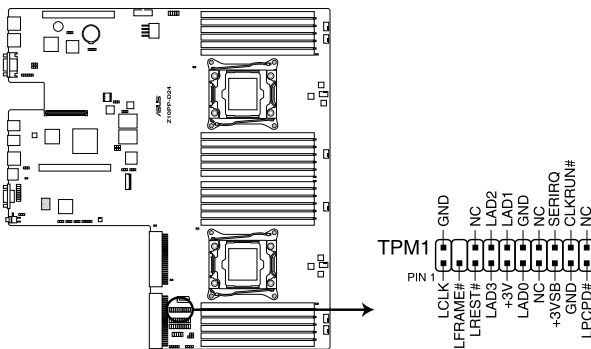

9. System panel connector (20-pin PANEL1)

This connector supports several chassis-mounted functions.

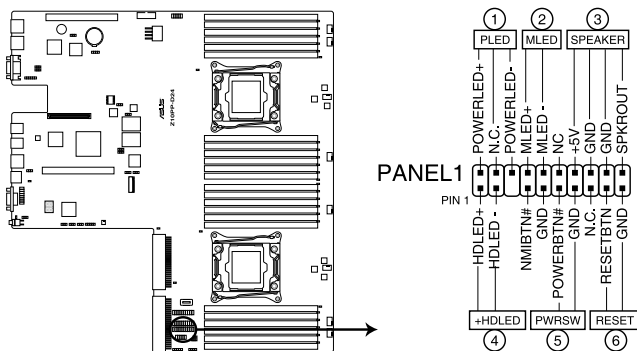

Z10PP-D24 System panel connector

- **System power LED (3-pin PLED)**

This 3-pin connector is for the system power LED. Connect the chassis power LED cable to this connector. The system power LED lights up when you turn on the system power, and blinks when the system is in sleep mode.

- **Message LED (2-pin MLED)**

This 2-pin connector is for the message LED cable that connects to the front message LED. The message LED is controlled by Hardware monitor to indicate an abnormal event occurrence.

- **System warning speaker (4-pin SPEAKER)**

This 4-pin connector is for the chassis-mounted system warning speaker. The speaker allows you to hear system beeps and warnings.

- **Hard disk drive activity LED (2-pin HDLED)**

This 2-pin connector is for the HDD Activity LED. Connect the HDD Activity LED cable to this connector. The IDE LED lights up or flashes when data is read from or written to the HDD.

- **ATX power button/soft-off button (2-pin PWRSW)**

This connector is for the system power button. Pressing the power button turns the system on or puts the system in sleep or soft-off mode depending on the BIOS settings. Pressing the power switch for more than four seconds while the system is ON turns the system OFF.

- **Reset button (2-pin RESET)**

This 2-pin connector is for the chassis-mounted reset button for system reboot without turning off the system power.

10. Auxiliary panel connector (20-2 pin AUX_PANEL1)

This connector is for additional front panel features including front panel SMB, locator LED and switch, chassis intrusion, and LAN LEDs.

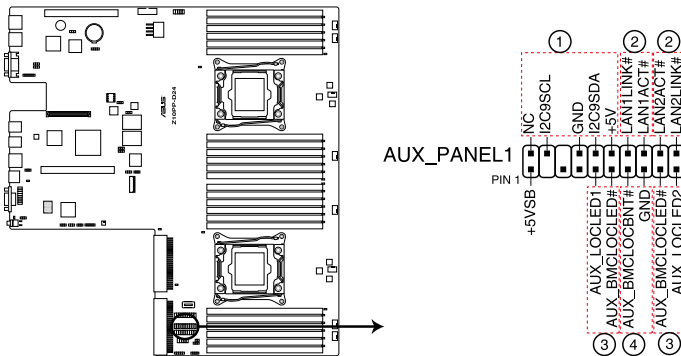

Z10PP-D24 Auxiliary panel connector

1. Front panel SMB (6-1 pin FPSMB)

These leads connect the front panel SMBus cable.

2. LAN activity LED (2-pin LAN1_LED, LAN2_LED)

These leads are for Gigabit LAN activity LEDs on the front panel.

3. Locator LED (2-pin LOCATORLED1 and 2-pin LOCATORLED2)

These leads are for the locator LED1 and LED2 on the front panel. Connect the Locator LED cables to these 2-pin connector. The LEDs will light up when the Locator button is pressed.

4. Locator Button/Switch (2-pin LOCATORBTN)

These leads are for the locator button on the front panel. This button queries the state of the system locator.

11. Power connectors (8-pin BPPWR1)

These connectors are for the power supply plugs that connects to the bayplane. The power supply plugs are designed to fit these connectors in only one orientation. Find the proper orientation and push down firmly until the connectors completely fit.

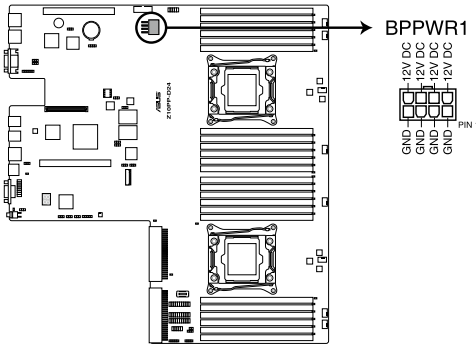

Z10PP-D24 ATX power connector

12. VGA connector (10-1 pin VGA_HDR1)

This connector supports the VGA High Dynamic-Range interface.

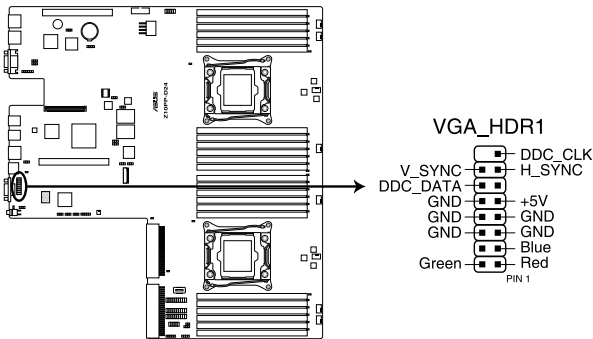

Z10PP-D24 Internal VGA connector

13. Mezzanine PCI card connector (MEZZPCIE1)

The MEZZPCIE1 connector supports Open Compute Project (OCP) cards.

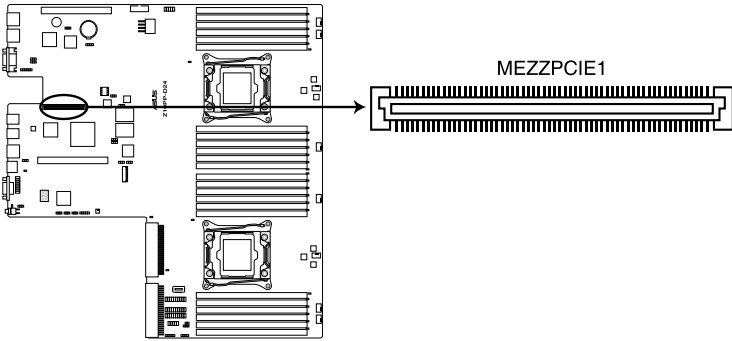

Z10PP-D24 MEZZPCIE1 connector

14. M.2 (NGFF) card connector (NGFF1)

This connector allows you to install an M.2 device.

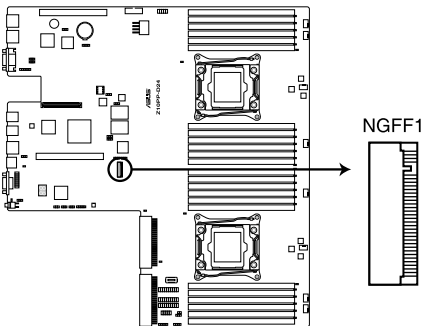

Z10PP-D24 NGFF1 connector



- This connector supports type 2242 devices on both PCI-E and SATA interface.
- If the M.2 slot is occupied, the SATA6G_6 slot will be disabled.



The M.2 (NGFF) device is purchased separately

15. Chassis Intrusion (2-pin INTRUSION1)

These leads are for the intrusion detection feature for chassis with intrusion sensor or microswitch. When you remove any chassis component, the sensor triggers and sends a high level signal to these leads to record a chassis intrusion event. The default setting is to short the CHASSIS# and the GND pin by a jumper cap to disable the function.

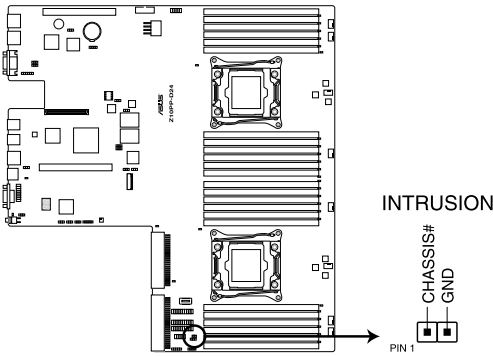

Z10PP-D24 Chassis Intrusion connector

16. RAID key connector (2-pin RAID_KEY1)

This connector is reserved for the LSI MegaRAID 5 function (PCH Software RAID). Plug the optional RAID key to enable it.

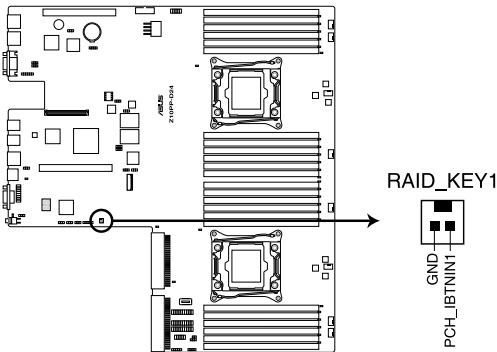

Z10PP-D24 RAID KEY

4.4 Internal LEDs

1. CPU Error LED (ERRCPU1, ERRCPU2)

The CPU Error LEDs light up to indicate failure of the corresponding CPU.

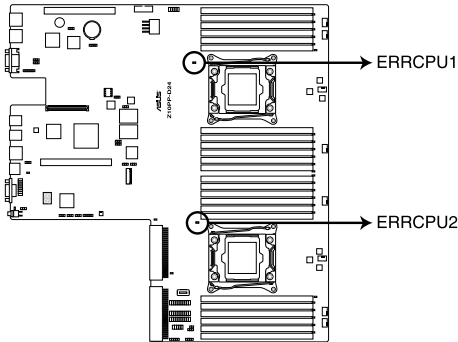

Z10PP-D24 ERR CPU LED

2. BMC LED (BMCLED1)

The BMC LED lights up to indicate that the on-board BMC is enabled.

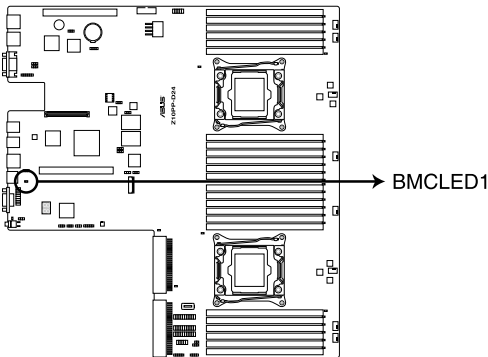

Z10PP-D24 BMC LED

3. DIMM warning LED (MEMERRA1-A3, MEMERRB1-B3, MEMERRC1-C3, MEMERRD1-D4, MEMERR1-E3, MEMERRF1-F3, MEMERRG1-G3, MEMERRH1-H3)

The DIMM warning LEDs light up to indicate that an impending failure of the corresponding DIMM.

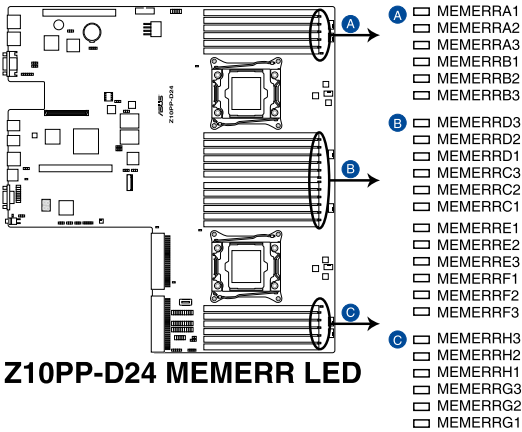

4. Location LED (LOCLED2)

This onboard LED lights up when the Location button on the server is pressed or when triggered by a system management software. The Location LED helps visually locate and quickly identify the server in error on a server rack.

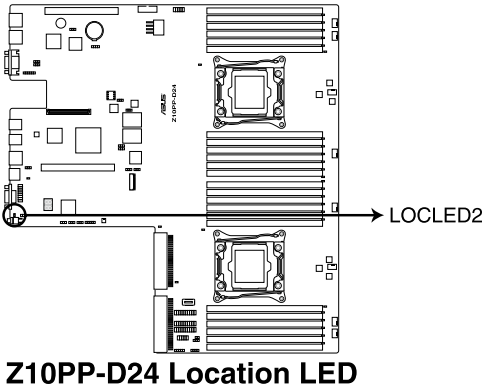

5. CATT LED (CATTERR1)

The CATT LED indicates that the system has experienced a fatal or catastrophic error and cannot continue to operate.

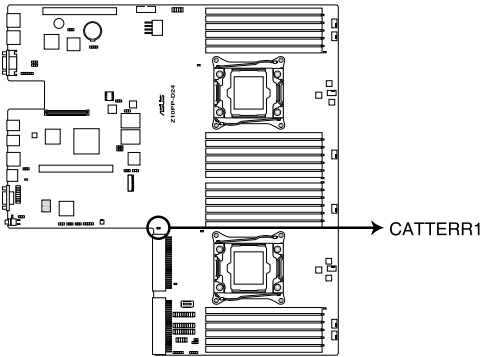

Z10PP-D24 CATTERR LED

6. OCPLAN Activity LED connector (4-pin OCP_LED1)

OCPLAN LED connector supports ASUS MCB-10G-2S OCP card Active LED.

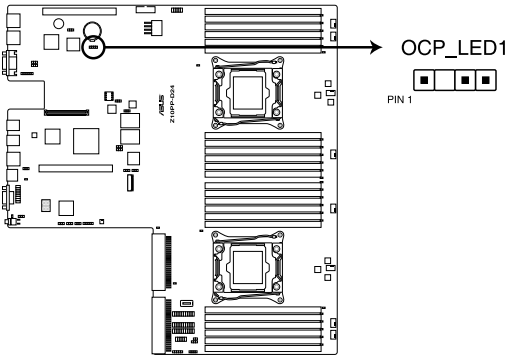

Z10PP-D24 OCP_LED1 connector

7. Q-Code LEDs (LED1)

The Q-Code LED provides a 2-digit display that shows the status of your system. Refer to the Q-Code table of this user guide for more information about the 2-digit codes.

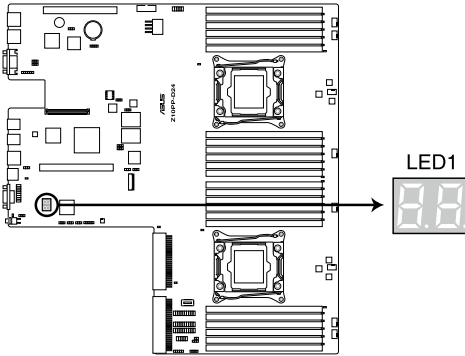

Z10PP-D24 Q-Code LED

Q-Code table

Code	Description
00	Not used
01	Power on. Reset type detection (soft/hard).
02	AP initialization before microcode loading
03	System Agent initialization before microcode loading
04	PCH initialization before microcode loading
06	Microcode loading
07	AP initialization after microcode loading
08	System Agent initialization after microcode loading
09	PCH initialization after microcode loading
0A	Initialization after microcode loading
0B	Cache initialization
0C – 0D	Reserved for future AMI SEC error codes
0E	Microcode not found
0F	Microcode not loaded
10	PEI Core is started
11 – 14	Pre-memory CPU initialization is started
15 – 18	Pre-memory System Agent initialization is started
19 – 1C	Pre-memory PCH initialization is started
2B – 2F	Memory initialization
30	Reserved for ASL (see ASL Status Codes section below)

(continued on the next page)

Q-Code table

Code	Description
31	Memory Installed
32 – 36	CPU post-memory initialization
37 – 3A	Post-Memory System Agent initialization is started
3B – 3E	Post-Memory PCH initialization is started
4F	DXE IPL is started
50 – 53	Memory initialization error. Invalid memory type or incompatible memory speed
54	Unspecified memory initialization error
55	Memory not installed
56	Invalid CPU type or Speed
57	CPU mismatch
58	CPU self test failed or possible CPU cache error
59	CPU micro-code is not found or micro-code update is failed
5A	Internal CPU error
5B	Reset PPI is not available
5C – 5F	Reserved for future AMI error codes
E0	S3 Resume is started (S3 Resume PPI is called by the DXE IPL)
E1	S3 Boot Script execution
E2	Video repost
E3	OS S3 wake vector call
E4 – E7	Reserved for future AMI progress codes
E8	S3 Resume Failed
E9	S3 Resume PPI not Found
EA	S3 Resume Boot Script Error
EB	S3 OS Wake Error
EC – EF	Reserved for future AMI error codes
F0	Recovery condition triggered by firmware (Auto recovery)
F1	Recovery condition triggered by user (Forced recovery)
F2	Recovery process started
F3	Recovery firmware image is found
F4	Recovery firmware image is loaded
F5 – F7	Reserved for future AMI progress codes
F8	Recovery PPI is not available
F9	Recovery capsule is not found
FA	Invalid recovery capsule
FB – FF	Reserved for future AMI error codes
60	DXE Core is started
61	NVRAM initialization
62	Installation of the PCH Runtime Services

Q-Code table (continued)

Code	Description
63 – 67	CPU DXE initialization is started
68	PCI host bridge initialization
69	System Agent DXE initialization is started
6A	System Agent DXE SMM initialization is started
6B – 6F	System Agent DXE initialization (System Agent module specific)
70	PCH DXE initialization is started
71	PCH DXE SMM initialization is started
72	PCH devices initialization
73 – 77	PCH DXE Initialization (PCH module specific)
78	ACPI module initialization
79	CSM initialization
7A – 7F	Reserved for future AMI DXE codes
90	Boot Device Selection (BDS) phase is started
91	Driver connecting is started
92	PCI Bus initialization is started
93	PCI Bus Hot Plug Controller Initialization
94	PCI Bus Enumeration
95	PCI Bus Request Resources
96	PCI Bus Assign Resources
97	Console Output devices connect
98	Console input devices connect
99	Super IO Initialization
9A	USB initialization is started
9B	USB Reset
9C	USB Detect
9D	USB Enable
9E – 9F	Reserved for future AMI codes
A0	IDE initialization is started
A1	IDE Reset
A2	IDE Detect
A3	IDE Enable
A4	SCSI initialization is started
A5	SCSI Reset
A6	SCSI Detect
A7	SCSI Enable
A8	Setup Verifying Password
A9	Start of Setup
AA	Reserved for ASL (see ASL Status Codes section below)
AB	Setup Input Wait

Q-Code table (continued)

Code	Description
AC	Reserved for ASL (see ASL Status Codes section below)
AD	Ready To Boot event
AE	Legacy Boot event
AF	Exit Boot Services event
B0	Runtime Set Virtual Address MAP Begin
B1	Runtime Set Virtual Address MAP End
B2	Legacy Option ROM Initialization
B3	System Reset
B4	USB hot plug
B5	PCI bus hot plug
B6	Clean-up of NVRAM
B7	Configuration Reset (reset of NVRAM settings)
B8–BF	Reserved for future AMI codes
D0	CPU initialization error
D1	System Agent initialization error
D2	PCH initialization error
D3	Some of the Architectural Protocols are not available
D4	PCI resource allocation error. Out of Resources
D5	No Space for Legacy Option ROM
D6	No Console Output Devices are found
D7	No Console Input Devices are found
D8	Invalid password
D9	Error loading Boot Option (LoadImage returned error)
DA	Boot Option is failed (StartImage returned error)
DB	Flash update is failed
DC	Reset protocol is not available

ACPI/ASL Checkpoints

Code	Description
0x01	System is entering S1 sleep state
0x02	System is entering S2 sleep state
0x03	System is entering S3 sleep state
0x04	System is entering S4 sleep state
0x05	System is entering S5 sleep state
0x10	System is waking up from the S1 sleep state
0x20	System is waking up from the S2 sleep state
0x30	System is waking up from the S3 sleep state
0x40	System is waking up from the S4 sleep state
0xAC	System has transitioned into ACPI mode. Interrupt controller is in PIC mode.
0xAA	System has transitioned into ACPI mode. Interrupt controller is in APIC mode.

BIOS setup

5

This chapter tells how to change the system settings through the BIOS Setup menus. Detailed descriptions of the BIOS parameters are also provided.

5.1 Managing and updating your BIOS

The following utilities allow you to manage and update the motherboard Basic Input/Output System (BIOS) setup:

1. **ASUS CrashFree BIOS 3**

To recover the BIOS using a bootable USB flash disk drive when the BIOS file fails or gets corrupted.

2. **ASUS EzFlash**

Updates the BIOS using a USB flash disk.

3. **BUPDATER**

Updates the BIOS in DOS mode using a bootable USB flash disk drive.

Refer to the corresponding sections for details on these utilities.



Save a copy of the original motherboard BIOS file to a bootable USB flash disk drive in case you need to restore the BIOS in the future. Copy the original motherboard BIOS using the BUPDATER utility.

5.1.1 **ASUS CrashFree BIOS 3 utility**

The ASUS CrashFree BIOS 3 is an auto recovery tool that allows you to restore the BIOS file when it fails or gets corrupted during the updating process. You can update a corrupted BIOS file using a USB flash drive that contains the updated BIOS file.



Prepare a USB flash drive containing the updated motherboard BIOS before using this utility.

Recovering the BIOS from a USB flash drive

To recover the BIOS from a USB flash drive:

1. Insert the USB flash drive with the original or updated BIOS file to one USB port on the system.
2. The utility will automatically recover the BIOS. It resets the system when the BIOS recovery finished.



DO NOT shut down or reset the system while recovering the BIOS! Doing so would cause system boot failure!



The recovered BIOS may not be the latest BIOS version for this motherboard. Visit the ASUS website at www.asus.com to download the latest BIOS file.

5.1.2 ASUS EZ Flash Utility

The ASUS EZ Flash Utility feature allows you to update the BIOS without having to use a DOS-based utility.



Before you start using this utility, download the latest BIOS from the ASUS website at www.asus.com.

To update the BIOS using EZ Flash Utility:

1. Insert the USB flash disk that contains the latest BIOS file into the USB port.
2. Enter the BIOS setup program. Go to the **Tool** menu then select **ASUS EZ Flash Utility**. Press <Enter>.

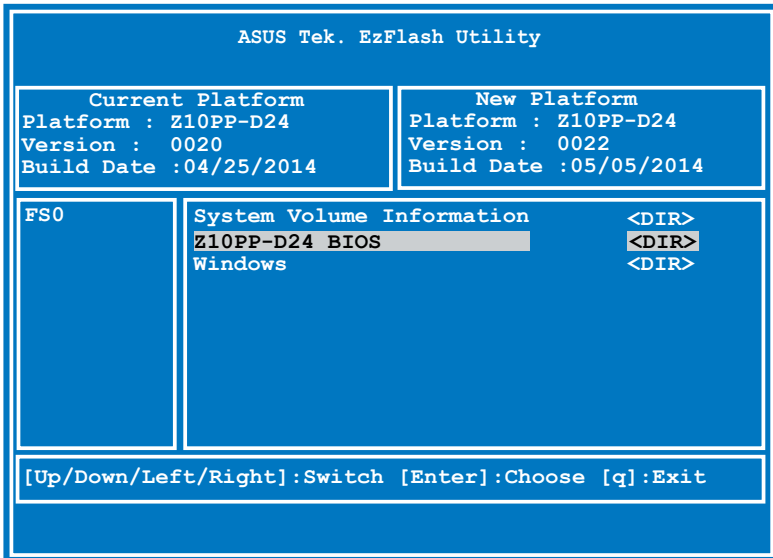

3. Press <Tab> to switch to the **Drive** field.
4. Press the Up/Down arrow keys to find the USB flash disk that contains the latest BIOS, then press <Enter>.
5. Press <Tab> to switch to the **Folder Info** field.
6. Press the Up/Down arrow keys to find the BIOS file, and then press <Enter> to perform the BIOS update process. Reboot the system when the update process is done.



-
- This function can support devices such as a USB flash disk with FAT 32/16 format and single partition only.
 - DO NOT shut down or reset the system while updating the BIOS to prevent system boot failure!
-



Ensure to load the BIOS default settings to ensure system compatibility and stability. Press <F5> and select **Yes** to load the BIOS default settings.

5.1.3 BUPDATER utility



The succeeding BIOS screens are for reference only. The actual BIOS screen displays may not be the same as shown.

The BUPDATER utility allows you to update the BIOS file in the DOS environment using a bootable USB flash disk drive with the updated BIOS file.

Updating the BIOS file

To update the BIOS file using the BUPDATER utility:

1. Visit the ASUS website at www.asus.com and download the latest BIOS file for the motherboard. Save the BIOS file to a bootable USB flash disk drive.
2. Copy the BUPDATER utility (BUPDATER.exe) from the ASUS support website at support.asus.com to the bootable USB flash disk drive you created earlier.
3. Boot the system in DOS mode, then at the prompt, type:

```
BUPDATER /i [filename].CAP
```

where [filename] is the latest or the original BIOS file on the bootable USB flash disk drive, then press <Enter>.

```
A:\>BUPDATER /i[file name].CAP
```

- The utility verifies the file, then starts updating the BIOS file.

```
ASUS Tek. EzFlash Utility

Current Platform          New Platform
Platform : Z10PP-D24     Platform : Z10PP-D24
Version : 0020            Version : 0022
Build Date :04/25/2014   Build Date :05/05/2014

FS0                      System Volume Information <DIR>
                          Z10PP-D24 BIOS <DIR>
                          Windows <DIR>

[Up/Down/Left/Right]:Switch [Enter]:Choose [q]:Exit
```



DO NOT shut down or reset the system while updating the BIOS to prevent system boot failure!

- The utility returns to the DOS prompt after the BIOS update process is completed. Reboot the system from the hard disk drive.

```
The BIOS update is finished! Please restart your system.
c:\>
```

5.2 BIOS setup program

This motherboard supports a programmable firmware chip that you can update using the provided utility described in section **5.1 Managing and updating your BIOS**.

Use the BIOS Setup program when you are installing a motherboard, reconfiguring your system, or prompted to “Run Setup.” This section explains how to configure your system using this utility.

Even if you are not prompted to use the Setup program, you can change the configuration of your computer in the future. For example, you can enable the security password feature or change the power management settings. This requires you to reconfigure your system using the BIOS Setup program so that the computer can recognize these changes and record them in the CMOS RAM of the firmware chip.

The firmware chip on the motherboard stores the Setup utility. When you start up the computer, the system provides you with the opportunity to run this program. Press during the Power-On Self-Test (POST) to enter the Setup utility; otherwise, POST continues with its test routines.

If you wish to enter Setup after POST, restart the system by pressing <Ctrl+Alt+Delete>, or by pressing the reset button on the system chassis. You can also restart by turning the system off and then back on. Do this last option only if the first two failed.

The Setup program is designed to make it as easy to use as possible. Being a menu-driven program, it lets you scroll through the various sub-menus and make your selections from the available options using the navigation keys.



-
- The default BIOS settings for this motherboard apply for most conditions to ensure optimum performance. If the system becomes unstable after changing any BIOS settings, load the default settings to ensure system compatibility and stability. Press <F5> and select **Yes** to load the BIOS default settings.
 - The BIOS setup screens shown in this section are for reference purposes only, and may not exactly match what you see on your screen.
 - Visit the ASUS website (www.asus.com) to download the latest BIOS file for this motherboard.
-

5.2.1 BIOS menu screen

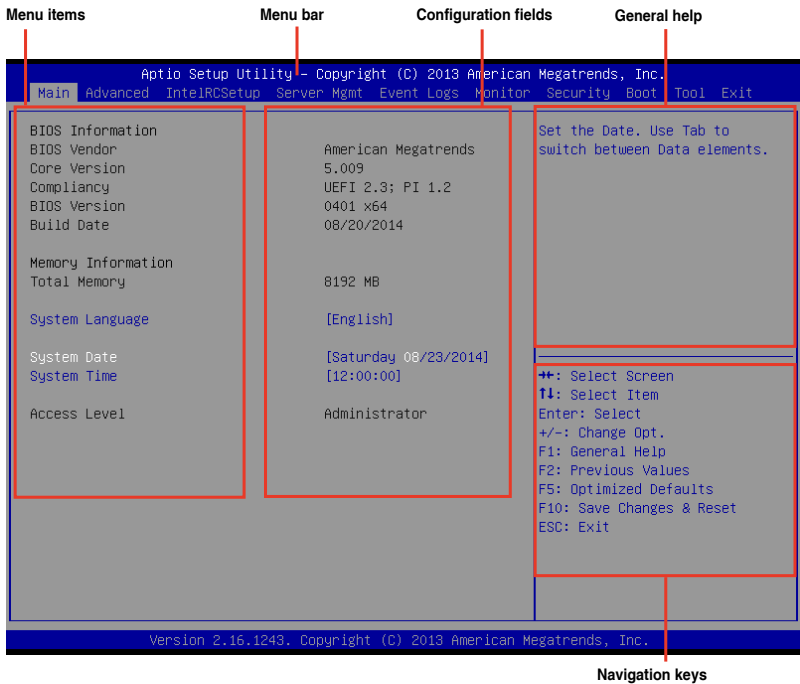

5.2.2 Menu bar

The menu bar on top of the screen has the following main items:

Main	For changing the basic system configuration
Advanced	For changing the advanced system settings
IntelRCSetup	For changing the Intel RC settings
Server Mgmt	For changing the Server Mgmt settings
Event Logs	For changing the event log settings
Monitor	For displaying the system temperature, power status, and changing the fan settings
Security	For changing the security settings
Boot	For changing the system boot configuration
Tool	For configuring options for special functions
Exit	For selecting the exit options

To select an item on the menu bar, press the right or left arrow key on the keyboard until the desired item is highlighted.

5.2.3 Menu items

The highlighted item on the menu bar displays the specific items for that menu. For example, selecting **Main** shows the Main menu items.

The other items (Event Logs, Advanced, Monitor, Boot, Tool, and Exit) on the menu bar have their respective menu items.

5.2.4 Submenu items

A solid triangle before each item on any menu screen means that the item has a submenu. To display the submenu, select the item then press <Enter>.

5.2.5 Navigation keys

At the bottom right corner of a menu screen are the navigation keys for the BIOS setup program. Use the navigation keys to select items in the menu and change the settings.

5.2.6 General help

At the top right corner of the menu screen is a brief description of the selected item.

5.2.7 Configuration fields

These fields show the values for the menu items. If an item is user-configurable, you can change the value of the field opposite the item. You cannot select an item that is not user-configurable.

A configurable field is enclosed in brackets, and is highlighted when selected. To change the value of a field, select it and press <Enter> to display a list of options.

5.2.8 Pop-up window

Select a menu item and press <Enter> to display a pop-up window with the configuration options for that item.

5.2.9 Scroll bar

A scroll bar appears on the right side of a menu screen when there are items that do not fit on the screen. Press the Up/Down arrow keys or <Page Up> /<Page Down> keys to display the other items on the screen.

5.3 Main menu

When you enter the BIOS Setup program, the Main menu screen appears. The Main menu provides you an overview of the basic system information, and allows you to set the system date, time, language, and security settings.

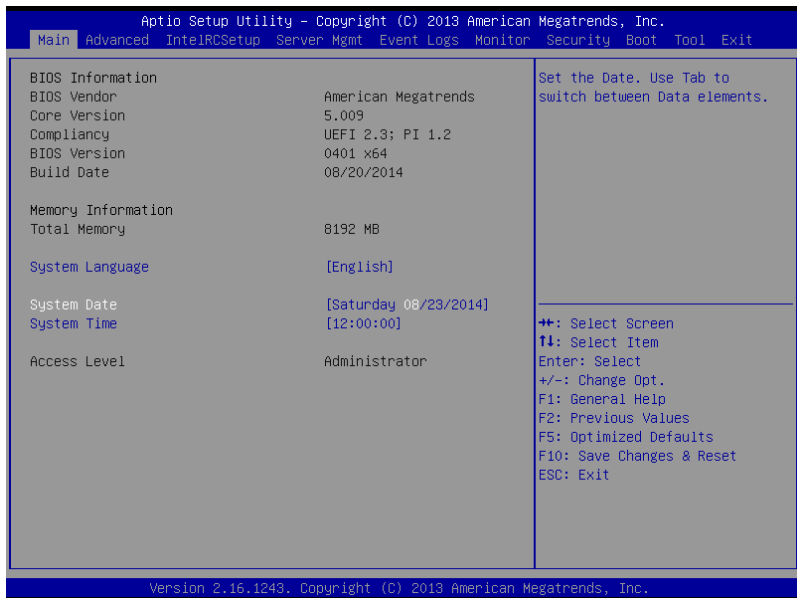

5.3.1 System Date [Day xx/xx/xxxx]

Allows you to set the system date.

5.3.2 System Time [xx:xx:xx]

Allows you to set the system time.

5.4 Advanced menu

The Advanced menu items allow you to change the settings for the CPU and other system devices.



Take caution when changing the settings of the Advanced menu items. Incorrect field values can cause the system to malfunction.

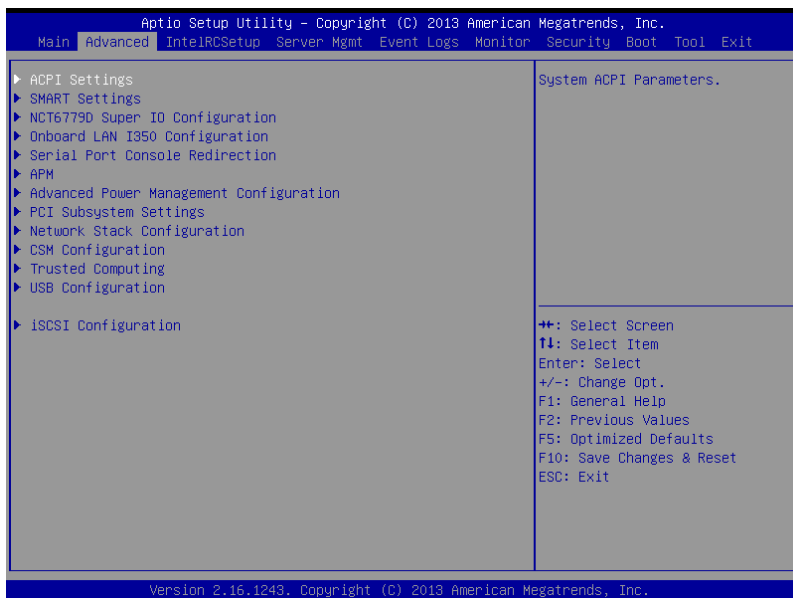

5.4.1 ACPI Settings

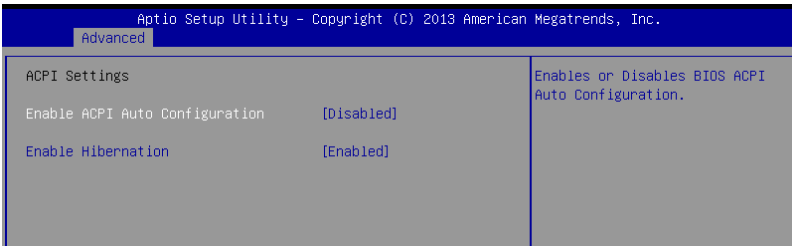

Enable ACPI Auto Configuration [Disabled]

Allows you to enable or disable the BIOS ACPI Auto Configuration.

Configuration options: [Disabled] [Enabled]

Enable Hibernation [Enabled]

Allows you to enable or disable the ability of the system to hibernate (OS/Sleep State).

Configuration options: [Disabled] [Enabled]



This option may be not effective with some OS.

5.4.2 Smart Settings

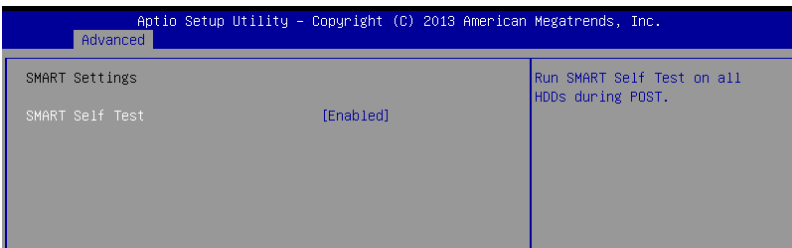

SMART Self Test [Enabled]

Allows you to run SMART Self Test on all HDDs during POST.

Configuration options: [Disabled] [Enabled]

5.4.3 NCT6779D Super IO Configuration

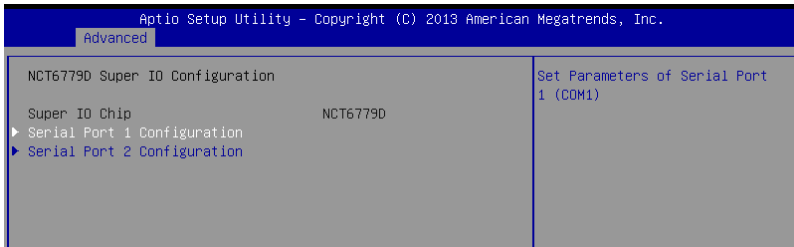

Serial Port 1 / Serial Port 2 Configuration

Allows you to set the parameters of Serial Port 1/ Serial Port 2.

Serial Port [Enabled]

Allows you to enable or disable Serial Port.

Configuration options: [Disabled] [Enabled]

Change Settings [Auto]

Allows you to choose the setting for Super IO device.

Configuration options: [Auto] [IO=3F8h; IRQ=4;] [IO=3F8h; IRQ=3, 4, 5, 6, 7, 9, 10, 11, 12;]
[IO=2F8h; IRQ=3, 4, 5, 6, 7, 9, 10, 11, 12;] [IO=3E8h; IRQ=3, 4, 5, 6, 7, 9, 10, 11, 12;]
[IO=2E8h; IRQ=3, 4, 5, 6, 7, 9, 10, 11, 12;]

5.4.4 Onboard LAN I350 IO Configuration

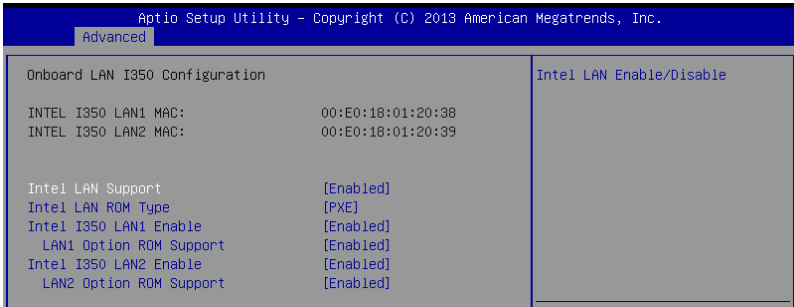

Intel LAN Support [Enabled]

Allows you to enable or disable the Intel LAN.

Configuration options: [Disabled] [Enabled]

Intel LAN ROM Type [PXE]

Allows you to select the Intel LAN ROM type.

Configuration options: [PXE] [SCSI]

Intel LAN I350 LAN1 / LAN2 Enable [Enabled]

Allows you to enable or disable the Intel LAN.

Configuration options: [Disabled] [Enabled]



The following items appear only when Intel LAN I350 LAN1 / LAN2 Enable is set to [Enabled].

LAN1/ LAN2 Option ROM Support [Enabled]

Allows you to load the Intel LAN ROM.

Configuration options: [Disabled] [Enabled]

Intel LAN I350 LAN3 / LAN4 Enable [Enabled]

Allows you to enable or disable the Intel LAN.

Configuration options: [Disabled] [Enabled]



The following items appear only when Intel LAN I350 LAN3 / LAN4 Enable is set to [Enabled].

LAN3/ LAN4 Option ROM Support [Enabled]

Allows you to load the Intel LAN ROM.

Configuration options: [Disabled] [Enabled]

5.4.5 Serial Port Console Redirection

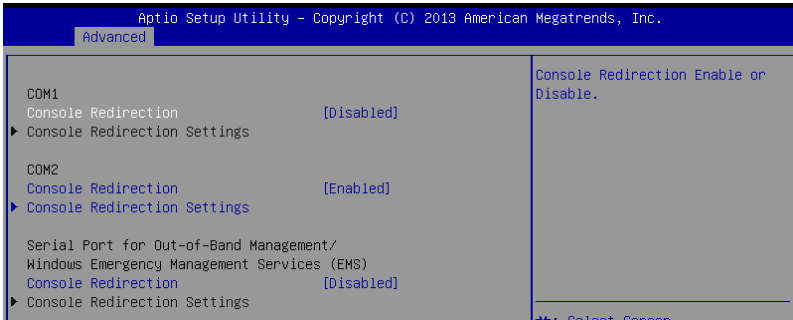

COM1/COM2

Console Redirection [Enabled]

Allows you to enable or disable the console redirection feature.

Configuration options: [Disabled] [Enabled]



The following item appears only when you set **Console Redirection** to [Enabled].

Console Redirection Settings

This item becomes configurable only when you enable the **Console Redirection** item. The settings specify how the host computer and the remote computer (which the user is using) will exchange data. Both computers should have the same or compatible settings.

Terminal Type [VT-UTF8]

Allows you to set the terminal type.

[VT100] ASCII char set.

[VT100+] Extends VT100 to support color, function keys, et.

[VT-UTF8] Uses UTF8 encoding to map Unicode chars onto 1 or more bytes

[ANSI] Extended ASCII char set

Bits per second [57600]

Selects serial port transmission speed. The speed must be matched on the other side. Long or noisy lines may require lower speeds.

Configuration options: [9600] [19200] [38400] [57600] [115200]

Data Bits [8]

Configuration options: [7] [8]

Parity [None]

A parity bit can be sent with the data bits to detect some transmission errors. [Mark] and [Space] parity do not allow for error detection.

[None]	None
[Even]	parity bit is 0 if the num of 1's in the data bits is even
[Odd]	parity bit is 0 if num of 1's in the data bits is odd
[Mark]	parity bit is always 1
[Space]	parity bit is always 0

Stop Bits [1]

Stop bits indicate the end of a serial data packet. (A start bit indicates the beginning.) The standard setting is 1 stop bit. Communication with slow devices may require more than 1 stop bit. Configuration options: [1] [2]

Flow Control [Hardware RTS/CTS]

Flow control can prevent data loss from buffer overflow. When sending data, if the receiving buffers are full, a "stop" signal can be sent to stop the data flow. Once the buffers are empty, a "start" signal can be sent to re-start the flow. Hardware flow control uses two wires to send start/stop signals.

Configuration options: [None] [Hardware RTS/CTS]

VT -UTF8 Combo Key Support [Enabled]

This allows you to enable the VT -UTF8 Combination Key Support for ANSI/VT100 terminals. Configuration options: [Disabled] [Enabled]

Recorder Mode [Disabled]

With this mode enabled only text will be sent. This is to capture Terminal data.

Configuration options: [Disabled] [Enabled]

Legacy OS Redirection Resolution [80x24]

This allows you to set the number of rows and columns supported on the Legacy OS.

Configuration options: [80x24] [80x25]

Putty Keypad [VT100]

This allows you to select the FunctionKey and Keypad on Putty. Configuration options: [VT100] [LINUX] [XTERMR6] [SCO] [ESCN] [VT400]

Redirection After BIOS POST [Always Enable]

This setting allows you to specify if Bootloader is selected than Legacy console redirection. Configuration options: [Always Enable] [Bootloader]

Serial Port for Out-of-Band Management/Windows Emergency Management Services (EMS)

Console Redirection [Disabled]

Allows you to enable or disable the console redirection feature.

Configuration options: [Disabled] [Enabled]



The following item appears only when you set **Console Redirection** to [Enabled].

Console Redirection Settings

Out-of-Band Mgmt Port [COM1]

Microsoft Windows Emergency Management Services (EMS) allow for remote management of a Windows Server OS through a serial port.

Configuration options: [COM1] [COM2]

Terminal Type [VT-UTF8]

Microsoft Windows Emergency Management Services (EMS) allow for remote management of a Windows Server OS through a serial port.

Configuration options: [VT100] [VT100+] [VT-UTF8] [ANSI]

Bits per second [115200]

Microsoft Windows Emergency Management Services (EMS) allow for remote management of a Windows Server OS through a serial port.

Configuration options: [9600] [19200] [57600] [115200]

Flow Control [None]

Microsoft Windows Emergency Management Services (EMS) allow for remote management of a Windows Server OS through a serial port.

Configuration options: [None] [Hardware RTS/CTS] [Software Xon/Xoff]

5.4.6 APM

Allows you to configure the Advance Power Management (APM) settings.

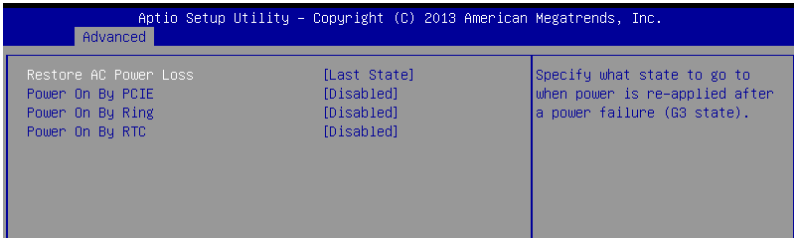

Restore AC Power Loss [Last State]

When set to [Power Off], the system goes into off state after an AC power loss. When set to [Power On], the system will reboot after an AC power loss. When set to [Last State], the system goes into either off or on state, whatever the system state was before the AC power loss.

Configuration options: [Power Off] [Power On] [Last State]

Power On By PCIE [Disabled]

[Disabled] Disables the PCIE devices to generate a wake event.

[Enabled] Enables the PCIE devices to generate a wake event.

Power On By Ring [Disabled]

[Disabled] Disables the PCIE devices to generate a wake event.

[Enabled] Enables the PCIE devices to generate a wake event.

Power On By RTC [Disabled]

[Disabled] Disables RTC to generate a wake event.

[Enabled] When set to [Enabled], the items **RTC Alarm Date (Days)** and **Hour/Minute/Second** will become user-configurable with set values.

5.4.7 Advanced Power Management Configuration

Allows you to configure the system's ACPI parameters.

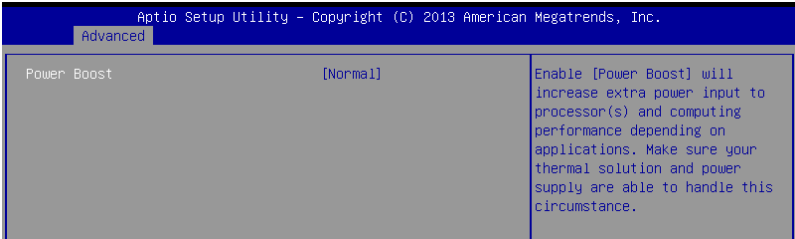

Power Boost [Normal]

This item increases extra power input to processor(s) and computing performance depending on applications.



Make sure your thermal solution and power supply are able to handle this circumstance.

Configuration options: [Normal] [High] [Extreme]

5.4.8 PCI Subsystem Settings

Allows you to configure PCI, PCI-X, and PCI Express Settings.

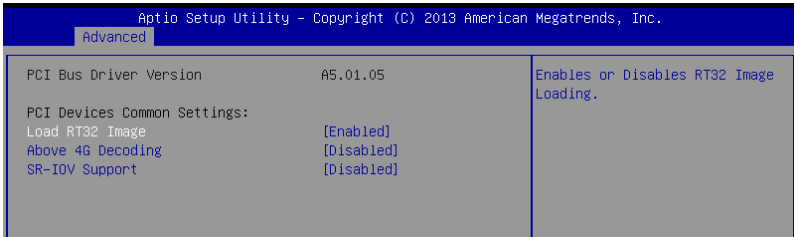

Load RT32 Image [Enabled]

Allows you to enable or disable RT32 Image Loading.

Configuration options: [Disabled] [Enabled]

Above 4G Decoding [Disabled]

Allows you to enable or disable 64-bit capable devices to be decoded in above 4G address space. It only works if the system supports 64-bit PCI decoding.

Configuration options: [Disabled] [Enabled]

SR-IOV Support [Disabled]

This option enables or disables Single Root IO Virtualization Support if the system has SR-IOV capable PCIe devices.

Configuration options: [Disabled] [Enabled]

5.4.9 Network Stack Configuration



Network stack [Disabled]

Enables or disables the network stack feature. Configuration options: [Disable] [Enable]



The following item appears only when **Network stack** is set to [Enabled].

Ipv4 PXE Support [Enabled]

Enables or disables the Ipv4 PXE Boot Support. If disabled, Ipv4 PXE boot option will not be created. Configuration options: [Disabled] [Enabled].

Ipv6 PXE Support [Enabled]

Enables or disables the Ipv6 PXE Boot Support. If disabled, Ipv6 PXE boot option will not be created. Configuration options: [Disabled] [Enabled].

PXE boot wait time [0]

Wait time to press ESC key to abort the PXE boot.

Media detect time [0]

Wait time (in seconds) to detect media.

5.4.10 CSM Configuration

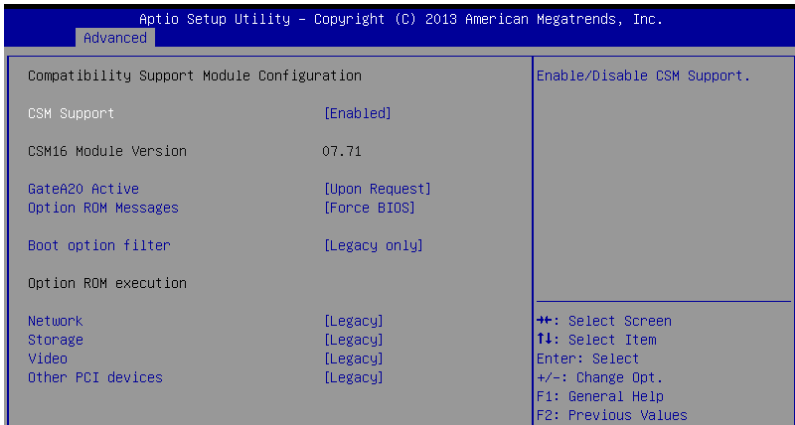

CSM Support [Enabled]

This option allows you to enable or disable CSM Support.

Configuration options: [Disabled] [Enabled]

GateA20 Active [Upon Request]

This allows you to set the GA20 option.

Configuration options: [Upon Request] [Always]

Option ROM Messages [Force BIOS]

This allows you to set the display mode for option ROM.

Configuration options: [Force BIOS] [Keep Current]

Boot Option filter [Legacy only]

This option allows you to control the Legacy/UEFI ROMs priority.

Configuration options: [UEFI and Legacy] [Legacy only] [UEFI only]

Network / Storage / Video [Legacy]

This option allows you to control the execution of UEFI and Legacy PXE/ Storage/ Video OpROM.

Configuration options: [UEFI] [Legacy]

Other PCI devices [Legacy]

This item determines the OpROM execution policy for devices other than Network, Storage, or Video.

Configuration options: [UEFI] [Legacy]

5.4.11 Trusted Computing

Aptio Setup Utility - Copyright (C) 2013 American Megatrends, Inc.		
Advanced		
Configuration		
Security Device Support	[Disabled]	Enables or Disables BIOS support for security device. O.S. will not show Security Device. TCG EFI protocol and INT1A interface will not be available.
Current Status Information		
NO Security Device Found		

Configuration

Security Device Support [Disabled]

Allows you to enable or disable the BIOS support for security device.

Configuration options: [Disabled] [Enabled]

5.4.12 USB Configuration

Aptio Setup Utility - Copyright (C) 2013 American Megatrends, Inc.	
Advanced	
USB Configuration	Enables Legacy USB support. AUTO option disables legacy support if no USB devices are connected. DISABLE option will keep USB devices available only for EFI applications.
USB Module Version	8.11.01
USB Devices:	
1 Drive, 1 Keyboard, 1 Mouse, 2 Hubs	
Legacy USB Support	[Enabled]
XHCI Hand-off	[Enabled]
EHCI Hand-off	[Disabled]
USB Mass Storage Driver Support	[Enabled]
Port 60/64 Emulation	[Enabled]
USB hardware delays and time-outs:	
USB transfer time-out	[20 sec]
Device reset time-out	[20 sec]
Device power-up delay	[Auto]
Mass Storage Devices:	
Generic 8.07	[Auto]
	↑↓: Select Screen ↑↓: Select Item Enter: Select +/-: Change Opt. F1: General Help F2: Previous Values F5: Optimized Defaults

Legacy USB Support [Enabled]

Allows you to enable or disable Legacy USB device support.

Configuration options: [Enabled] [Disabled] [Auto]

XHCI Hand-off [Enabled]

This is a workaround for OSes without XHCI hand-off support. The XHCI ownership change should be claimed by XHCI driver.

Configuration options: [Disabled] [Enabled]

EHCI Hand-off [Disabled]

This is a workaround for OSes without EHCI hand-off support. The EHCI ownership change should be claimed by EHCI driver.

Configuration options: [Disabled] [Enabled]

USB Mass Storage Driver Support [Enabled]

Allows you to enable or disable the USB Mass Storage driver support.

Configuration options: [Disabled] [Enabled]

Port 60/64 Emulation [Enabled]

This allows you to enable the I/O port 60h/64h emulation support. This should be enabled for the complete USB keyboard legacy support for non-USB aware OSes.

Configuration options: [Disabled] [Enabled]

USB hardware delays and time-outs

USB transfer time-out [20 sec]

The time-out value for control, bulk, and interrupt transfer.

Configuration options: [1 sec] [5 sec] [10 sec] [20 sec]

Device reset time-out [20 sec]

USB mass storage device start unit command time-out.

Configuration options: [10 sec] [20 sec] [30 sec] [40 sec]

Device power-up delay [Auto]

This is the maximum time the device will take before it properly reports itself to the host controller.

Configuration options: [Auto] [Manual]

Mass Storage Devices

Generic 8.07 [Auto]

Allows you to select the mass storage device emulation type.

Configuration options: [Auto] [Floppy] [Forced FDD] [Hard Disk] [CD-ROM]

5.4.13 iSCSI Configuration

Allows you to configure the iSCSI parameters.

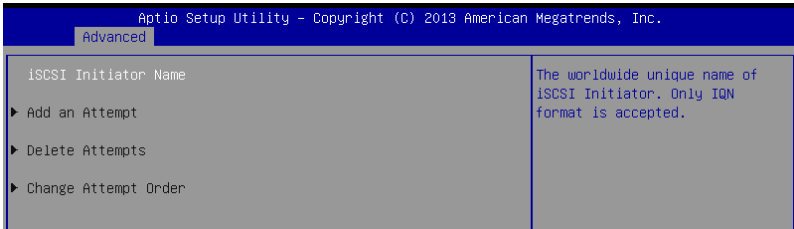

5.5 IntelRCSetup menu

The IntelRCSetup menu items allow you to change the processor and chipset settings.

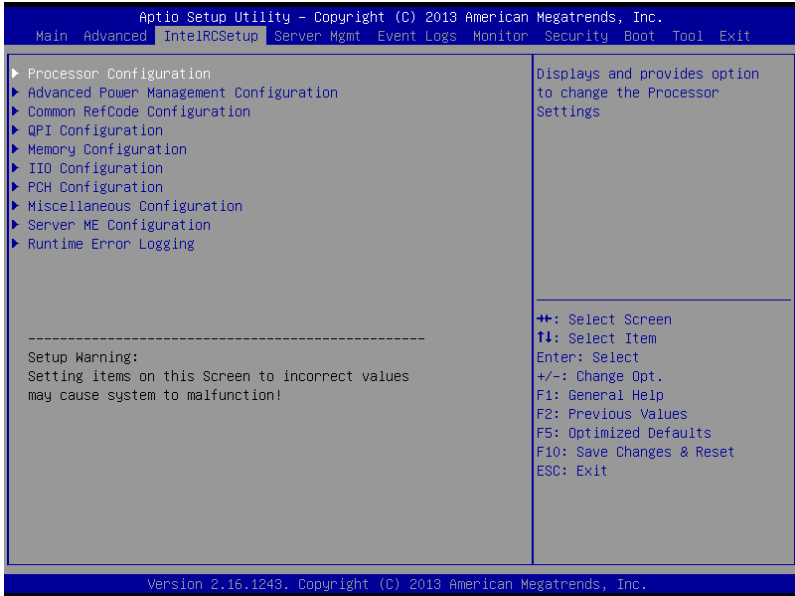

5.5.1 Processor Configuration

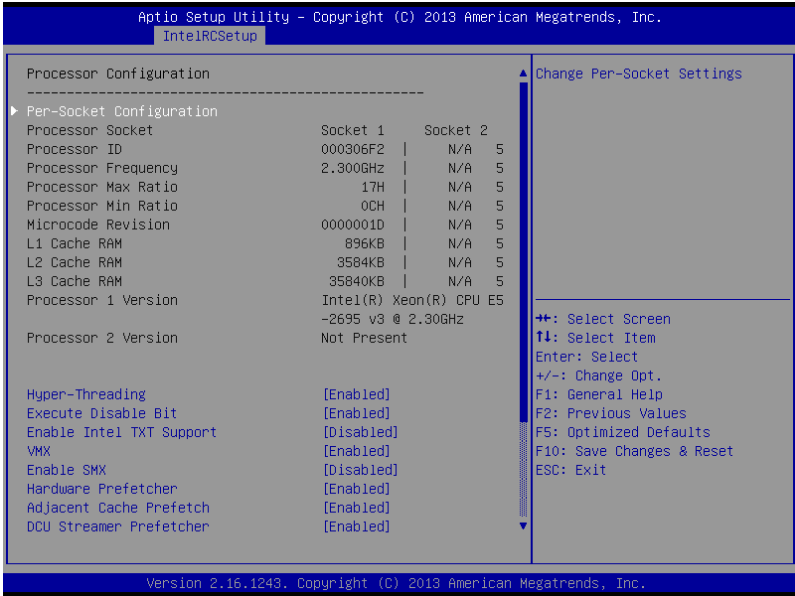

Per Socket Configuration

Allows you to set the number of cores to enable. 0 means all cores. Total of 14 cores available.

Hyper Threading [Enabled]

Allows you to enable or disable the Intel® Hyper-Threading Technology function. When disabled, only one thread per activated core is enabled.

Configuration options: [Disabled] [Enabled]

Execute Disable Bit [Enabled]

XD can prevent certain classes of malicious buffer overflow attacks when combined with a supporting OS (Windows Server 2003 SP1, Windows XP SP2, SuSE Linux 9.2, Redhat Enterprise 3 Update 3).

Configuration options: [Disabled] [Enabled]

Enable Intel TXT Support [Disabled]

Forces the XD feature log to always return 0 when disabled.

Configuration options: [Disabled] [Enabled]

VMX [Enabled]

Enables the Vanderpool Technology. Takes effect after reboot.

Configuration options: [Disabled] [Enabled]

Enable SMX [Disabled]

Enables the Safer Mode Extensions

Configuration options: [Disabled] [Enabled]

Hardware Prefetcher [Enabled]

This Item allows you to turn on/off the mid level cache(L2) streamer prefetcher.

Configuration options: [Disabled] [Enabled]

Adjacent Cache Prefetch [Enabled]

This Item allows you to turn on/off prefetching of adjacent cache lines.

Configuration options: [Disabled] [Enabled]

DCU Streamer Prefetcher [Enabled]

This Item allows you to enable or disable prefetcher of next L1 data line.

Configuration options: [Disabled] [Enabled]

DCU IP Prefetcher [Enabled]

This Item allows you to enable or disable prefetch of next L1 line based upon sequential load history.

Configuration options: [Disabled] [Enabled]

DCU Mode [32K 8Way Without ECC]

Configuration options: [32K 8Way Without ECC] [16K 4Way With ECC]

Direct Cache Access (DCA) [Auto]

This Item allows you to enable or disable Direct Cache Access.

Configuration options: [Auto] [Disabled] [Enabled]

DCA Prefetch Delay [32]

This Item allows you to set the time for the DCA Prefetch delay Help.

Configuration options: [Disabled] [8] [16] [24] [32] [40] [48] [56] [64] [72] [80] [88] [96] [104] [112]

X2APIC [Disabled]

This Item allows you to enable or disable the extended APIC support.

Configuration options: [Disabled] [Enabled]

AES-NI [Enabled]

This Item allows you to enable or disable the AES-NI support.

Configuration options: [Disabled] [Enabled]

Down Stream Peci [Disabled]

This Item allows you to enable the PCIe Down Stream Peci writer.

Configuration options: [Disabled] [Enabled]

5.5.2 Advanced Power Management Configuration

Power Technology [Energy Efficient]

This item allows you to enable power management features.
Configuration options: [Disabled] [Energy Efficient] [Custom]

Config TDP [Disabled]

This item allows you to enable/disable the Config TDP.
Configuration options: [Disabled] [Enabled]

CPU Advanced PM Turning

Energy Perf BIAS

Energy Performance Tuning [Disabled]

Allows you to select whether BIOS or Operating System chooses energy performance bias tuning.
Configuration options: [Disabled] [Enabled]

Energy Performance BIAS setting. [Balanced Performance]

Allows you to switch between Power or performance.
Configuration options: [Performance] [Balanced Performance] [Balanced Power] [Power]

Power/Performance switch [Enabled]

Allows you to switch between Power or performance.
Configuration options: [Disabled] [Enabled]

Workload Configuration [Balanced]

Optimization for the workload characterization.
Configuration options: [Balanced] [I/O sensitive]

Workload Configuration [23]

This is used to control the effective window of the average for CO and PO time.

PO TotalTimeThreshold Low [35]

The HW switching mechanism disables the performance setting (0) when the total PO time is less than this threshold.

PO TotalTimeThreshold High [58]

The HW switching mechanism enables the performance setting (0) when the total PO time is greater than this threshold.

5.5.3 Common RefCode Configuration

Numa [Enabled]

This item enables or disables the Non uniform Memory Access (NUMA).
Configuration options: [Disabled] [Enabled]

5.5.4 QPI Configuration

QPI General Configuration

QPI Status

This item displays information about the QPI status.

Link Speed Mode [Fast]

This item allows you to select the QPI link speed as either the fast mode or slow mode.

Configuration options: [Slow] [Fast]

Link Frequency Select [Auto]

This item allows for selecting the QPI link frequency

Configuration options: [Auto] [6.4 GT/s] [8.0 GT/s] [9.6 GT/s]

QPI Link0p [Enable]

Configuration options: [Disable] [Enable]

QPI Link1 [Enable]

Configuration options: [Disable] [Enable]

5.5.5 Memory Configuration

Enforce POR [Auto]

Allows you to enforce POR restrictions for DDR4 frequency and voltage programming.
Configuration options: [Auto] [Enforce POR] [Disabled] [Enforce Stretch Goals]

Memory Frequency [Auto]

Allows you to select the memory frequency setting.
Configuration options: [Auto] [1333] [1600] [1866] [2133]

Halt on mem Training Error [Enabled]

Allows you to enable or disable halt on mem Training Error.
Configuration options: [Disabled] [Enabled]

ECC Support [Auto]

Allows you to enable or disable the ECC support.
Configuration options: [Auto] [Disabled] [Enabled]

Enhanced Log Parsing [Disabled]

Allows you to enable additional output in debug log for easier machine parsing.
Configuration options: [Disabled] [Enabled]

Data Scrambling [Auto]

Allows you to enable/disable data scrambling.
Configuration options: [Auto] [Disabled] [Enabled]

Enable ADR [Disabled]

Allows you to set the detecting and enabling of ADR.
Configuration options: [Disabled] [Enabled]

C/A Parity Enable [Auto]

Allows you to enable or disable the DDR4's command address parity.
Configuration options: [Auto] [Disabled] [Enabled]

Memory Topology

Displays memory topology with DIMM population information.

Memory Thermal

Allows you to configure thermal settings.

Set Throttling Mode [Disabled]

Configuration options: [Disabled] [OLTT] [CLTT]

OLLT Peak BW [xxx]

Allows you to set the peak allowed bandwidth for OLTT. This is in percentage and valid offset values is from 25-100.

DIMM Tem Stat [xx]

Allows you to select DIMMTEMPSTAT as temp_mid or temp_hi.

Memory Power Savings Mode [Auto]

Allows you to configure the CKE and other related Memory Power Savings features.

Configuration options: [Auto] [Disabled] [APD On] [User Defined] [Reserve] [Reserved]

Memory Power Savings Advanced Options

CK in SR [Auto]

Configuration options: [Auto] [Driven] [Tri-State] [Pulled Low] [Pulled High]

MDLL Off [Auto]

Allows you to shutdown MDLL during SR when enabled.

Configuration options: [Auto] [Disabled] [Enabled]

MEMHOT Throttling Mode [Input-only]

Allows you to shutdown MDLL during SR when enabled.

Configuration options: [Disabled] [Input-only] [Output-only]

Mem Electrical Throttling [Disabled]

Allows you to configure Memory Electrical throttling.

Configuration options: [Disabled] [Enabled] [Auto]

Memory Map

Channel Interleaving [Auto]

Select different channel interleaving setting.

Configuration options: [Auto] [1-way Interleave] [2-way Interleave] [3-way Interleave] [4-way Interleave]

Rank Interleaving [Auto]

Select different rank interleaving setting.

Configuration options: [Auto] [1-way Interleave] [2-way Interleave] [4-way Interleave] [8-way Interleave]

Memory RAS Configuration

RAS Mode [Disabled]

Allows you to enable or disable RAS Modes. Enabling Sparing and Mirroring is not supported. In case enabled, Sparing will be selected.

Configuration options: [Disabled] [Mirror] [Lockstep Mode]

Memory Rank Sparing [Disabled]

Allows you to enable or disable Memory Rank Sparing.

Configuration options: [Disabled] [Enabled]

Correctable Error Threshold [32767]

Allows you to set the Correctable Error Threshold used for sparing, tagging, and leaky bucket. The range is from 1 to 32767.

Patrol Scrub [Enabled]

Allows you to enable or disable Patrol Scrub.

Configuration options: [Disabled] [Enabled]

Demand Scrub [Enabled]

Allows you to enable or disable Demand Scrub.

Configuration options: [Disabled] [Enabled]

5.5.6 I/O Configuration

EV DFX Features [Disabled]

Set this option to allow DFX Lock Bits to remain clear.

Configuration options: [Disabled] [Enabled]

PCI Slot Option ROM Configuration

PCI E1/ PCIE2/ MEZZPCIE1 Option ROM [Enabled]

Allows you to enable or disable the PCIE1/ PCIE2/ MEZZPCIE1 Option ROM.

Configuration options: [Disabled] [Enabled]

Intel VT for Directed I/O (VT-d)

Intel VT for Directed I/O (VT-d) [Enabled]

Allows you to enable or disable the Intel Virtualization Technology for Directed I/O.

Configuration options: [Disabled] [Enabled]

PCI Express Global Options

TX EQ WA [Enabled]

Use special table for TX_EQ and vendor specific cards.

Configuration options: [Disabled] [Enabled]

PCI-E ASPM Support (Global) [L1 Only]

This option enables or disables the ASPM support for all downstream devices.

Configuration options: [Disabled] [L1 Only]

5.5.7 PCH Configuration

PCH Devices

DeepSx Power Policies [Disabled]

Allows you to configure the DeepSx Mode configuration.

Configuration options: [Disabled] [Enabled in S5] [Enabled in S4 and S5]

PCI Express Configuration

PCH DMI ASPM [Enabled]

Allows you to configure the PCH DMI ASPM.

Configuration options: [Disabled] [Enabled]

PCI Express root Port 1: NGFF1

Allows you to configure the PCI Express Root port settings.

PCI Express ASPM [Disable ASPM]

Allows you to configure the PCH DMI ASPM.

Configuration options: [Disable ASPM] [ASPM L0s] [ASPM L1] [ASPM L0sL1] [ASPM Auto]

PCH sSATA Configuration

sSATA Controller [Enabled]

Allows you to enable or disable the sSATA Controller.

Configuration options: [Disabled] [Enabled]

Configure sSATA as [AHCI]

Allows you to identify the SATA port is connected to Solid State Drive or Hard Disk Drive.

Configuration options: [IDE] [AHCI] [RAID]

SATA Mode options

SATA LED locate [Enabled]

If enabled, LED/SGPIO hardware is attached.

Configuration options: [Disabled] [Enabled]

Support Aggressive Link Power Management [Enabled]

Allows you to enable or disable the Support Aggressive Link Power (SALP) Management.

Configuration options: [Disabled] [Enabled]

SATA Port 1/ SATA Port 2/ SATA Port 3/ SATA Port 4

Port 1/ Port 2/ Port 3/ Port 4

Allows you to enable or disable the SATA port

Configuration options: [Disabled] [Enabled]

PCH SATA Configuration

SATA Controller [Enabled]

Allows you to enable or disable the SATA Controller.

Configuration options: [Disabled] [Enabled]

Configure SATA as [AHCI]

Allows you to identify the SATA port is connected to Solid State Drive or Hard Disk Drive.

Configuration options: [IDE] [AHCI] [RAID]

SATA Mode options

SATA LED locate [Enabled]

If enabled, LED/SGPIO hardware is attached.

Configuration options: [Disabled] [Enabled]

Support Aggressive Link Power Management [Enabled]

Allows you to enable or disable the Support Aggressive Link Power (SALP) Management.

Configuration options: [Disabled] [Enabled]

SATA Port 1~6

Port 1/ Port 2/ Port 3/ Port 4/ Port 5/ Port 6 [Enabled]

Allows you to enable or disable the SATA port

Configuration options: [Disabled] [Enabled]

USB Configuration

xHCI Mode [Auto]

Allows you to enable or disable the mode of operation of xHCI controller.

Configuration options: [Auto] [Disabled] [Enabled]

USB Ports Per-Port Disable Control [Disabled]

Allows you to control each of the USB ports 1 to 8 disabling.

Configuration options: [Disabled] [Enabled]



The following items appears only when the USB Ports Per-Port Disable Control is set to [Enabled].

USB Port #1/ #2/ #3/ #4/ #5/ #6/ #7/ #8/ #10 [Enabled]

Configuration options: [Disabled] [Enabled]

USB 3.0 Port #1/ #2/ #3/ #4 [Enabled]

Configuration options: [Disabled] [Enabled]

Platform Thermal Configuration

PCH Thermal Device [Auto]

Allows you to enable or disable the PCH Thermal Device (D31:F6).

Configuration options: [Auto] [Disabled] [Enabled]

Alert Enable Lock [Disabled]

Allows you to lock all Alert Enable settings.

Configuration options: [Disabled] [Enabled]

5.5.8 Miscellaneous Configuration

Active Video [Offboard Device]

Allows you to select the video type.

Configuration options: [Onboard Device] [Offboard Device]

5.5.9 Server ME Configuration

Displays the Server ME Technology parameters on your system.

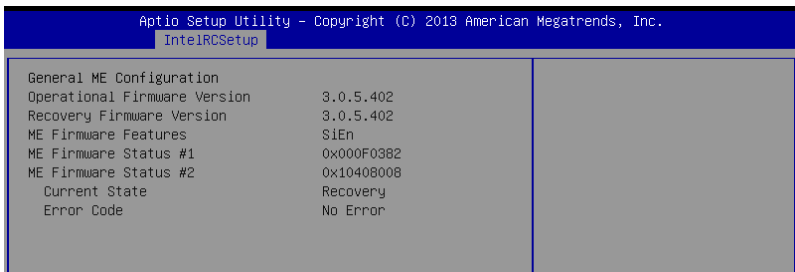

5.5.10 Runtime Error Logging Support

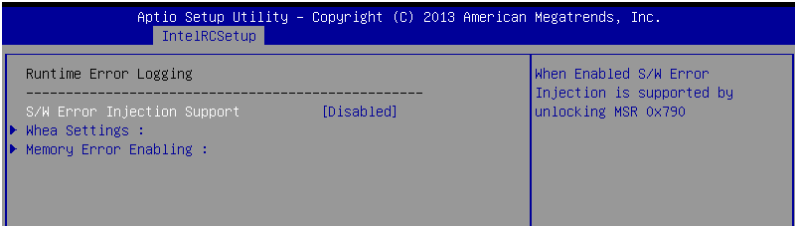

Runtime Error Logging

S/W Error Injection Support [Disabled]

This item, when enabled, is supported by unlocking MSR 0x790.

Configuration options: [Disabled] [Enabled]

Whea Settings

Whea Support [Disabled]

This item allows you to enable or disable the WHEA support.

Configuration options: [Disabled] [Enabled]

Memory Error Enabling

Memory corrected Error enabling [Disabled]

This item allows you to enable or disable the WHEA Memory corrected errors

Configuration options: [Disabled] [Enabled]

5.6 Server Mgmt menu

The Server Management menu displays the server management status and allows you to change the settings.

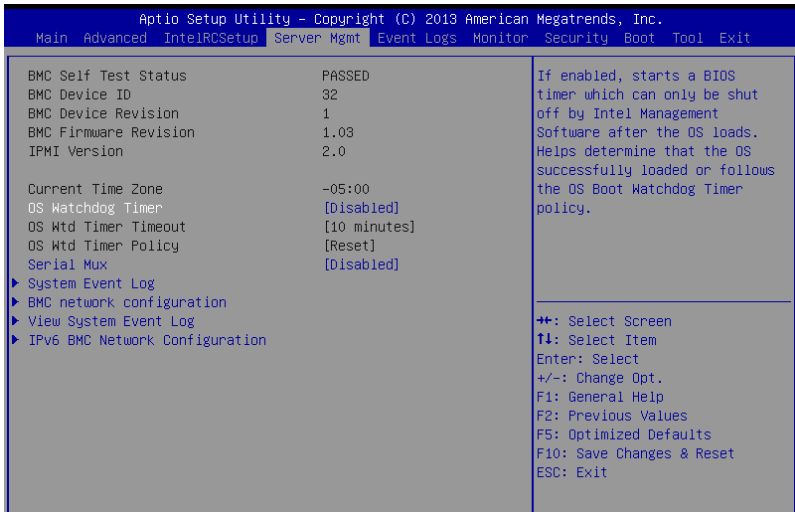

OS Watchdog Timer [Disabled]

This item allows you to start a BIOS timer which can only be shut off by Intel Management Software after the OS loads.

Configuration options: [Disabled] [Enabled]



The following items is configurable only when the OS Watchdog Timer is set to **[Enabled]**.

OS Wtd Timer Timeout [10 minutes]

Allows you to configure the length for the OS Boot Watchdog Timer.

Configuration options: [5 minutes] [10 minutes] [15 minutes] [20 minutes]

OS Wtd Timer Policy [Reset]

This item allows you to configure how the system should respond if the OS Boot Watchdog Timer expires.

Configuration options: [Do Nothing] [Reset] [Power Down]

Serial Mux [Disabled]

This item allows you to enable or disable Serial Mux configuration.

Configuration options: [Disabled] [Enabled]

System Event Log

Allows you to change the SEL event log configuration.

SEL Components [Enabled]

Allows you to enable or disable all features of system Event Logging during boot.

Configuration options: [Disabled] [Enabled]



- The following items appears only when you set **SEL Components** to [Enabled].
- All values changed here do not take effect until computer is restarted.

Erase SEL [No]

Allows you to choose options for erasing SEL.

Configuration options: [No] [Yes, On next reset] [Yes, On every reset]

When SEL is Full [Do Nothing]

Allows you to choose options for reactions to a full SEL.

Configuration options: [Do Nothing] [Erase Immediately]

Log EFI Status Codes [Error code]

Disable the logging of EFI Status Codes, or log only error code, or only progress code or, both.

Configuration options: [Disabled] [Both] [Error code] [Progress code]

Bmc network configuration

The sub-items in this configuration allow you to configure the BMC network parameters.

Aptio Setup Utility - Copyright (C) 2013 American Megatrends, Inc.
Server Mgmt

BMC network configuration	Select to configure LAN channel parameters statically or dynamically(by BIOS or BMC). Unspecified option will not modify any BMC network parameters during BIOS phase
DM_LAN1	
DM_LAN1 IP Address in BMC :	192.168.254.020
DM_LAN1 Subnet Mask in BMC :	255.255.255.000
DM_LAN1 Gateway Address in BMC :	000.000.000.000
DM_LAN1 MAC Address in BMC :	00.E1.E2.3A.3B.3C
DM_LAN1 Address Source in BMC :	Static Mode
Configuration Address source	[Previous State]
LAN1	
LAN1 IP Address in BMC :	000.000.000.000
LAN1 Subnet Mask in BMC :	000.000.000.000
LAN1 Gateway Address in BMC :	000.000.000.000
LAN1 MAC Address in BMC :	00.E1.E2.4A.4B.4C
LAN1 Address Source in BMC :	DHCP Mode
Configuration Address source	[Previous State]

++: Select Screen
F1: Select Item
Enter: Select
+/-: Change Opt.
F1: General Help
F2: Previous Values
F5: Optimized Defaults

Configuration Address source DM_LAN1/LAN1 [Previous State]

This item allows you to configure LAN channel parameters statistically or dynamically (by BIOS or BMC). Unspecified option will not modify any BMC network parameters during BIOS phase.

Configuration options: [Previous State] [Static] [DynamicBmcDhcp] [DynamicBmcNonDhcp]

View System Event Log

This item allows you to view the system event log records.

IPv6 BMC Network Configuration

This item allows you to configure the parameter settings of IPv6 BMC network.

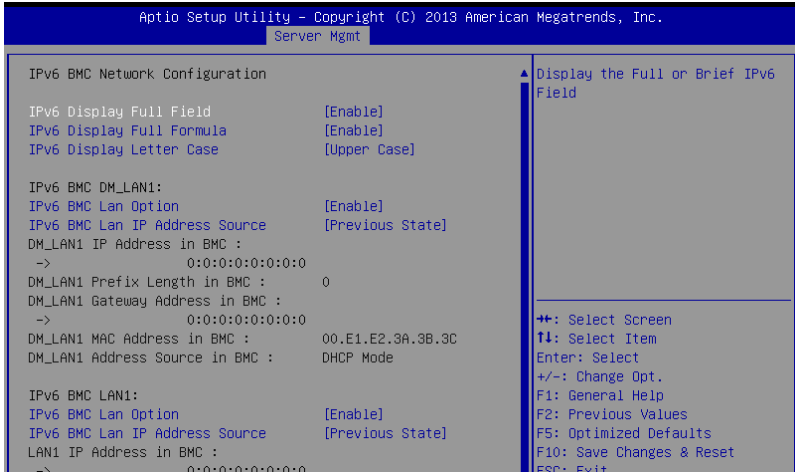

IPv6 Display Full Field [Enable]

Displays the full or brief IPv6 Field.

Configuration options: [Disable] [Enable]

IPv6 Display Full Formula [Enable]

Displays the full or brief IPv6 Formula.

Configuration options: [Disable] [Enable]

IPv6 Display Letter Case [Upper Case]

Displays the uppercase or lowercase letters of the alphabet.

Configuration options: [Lower Case] [Upper Case]

IPv6 BMC Lan Option [Enable]

This item allows you to enable or disable the IPv6 BMC LAN channel function.

Disabling this item will not modify any BMC network during BIOS phase.

Configuration options: [Disable] [Enable]

IPv6 BMC LAN IP Address source [Previous State]

Select to configure LAN channel parameters statically or dynamically (by BIOS or BMC).

Configuration options: [Previous State] [Static] [Dynamic-Obtained by BMC running DHCP]



The following items appear only when you set **IP BMC Lan IP Address Source** to [Static].

IPv6 BMC LAN IP Address

Allows you to input IPv6 BMC Lan IP address.

IPv6 BMC LAN IP Prefix Length

Allows you to input IPv6 BMC Lan IP Prefix Length.

IPv6 BMC LAN Default Gateway

Allows you to input IPv6 BMC Lan Default Gateway.

IPv6 BMC LAN DNS Settings

Allows you to enter IPv6 BMC LAN DNS Settings.

IPv6 BMC LAN Link IP Address

Allows you to enter IPv6 BMC LAN Link IP address.

IPv6 BMC LAN Link IP Prefix Length

Allows you to input IPv6 BMC Lan Link IP Prefix Length.

IPv6 BMC Lan Option [Enable]

This item allows you to enable IPv6 BMC LAN channel function. Disabling this option will not modify any BMC network during BIOS phase.



The following item appears only when you set **IP BMC Lan Option** to [Enable].

IPv6 BMC LAN IP Address Source [Previous State]

Select to configure LAN channel parameters statically or dynamically (by BIOS or BMC).

Configuration options: [Previous State] [Static] [Dynamic-Obtained by BMC running DHCP]



The following items appear only when you set **IP BMC Lan IP Address Source** to [Static].

IPv6 BMC LAN IP Address

Allows you to input IPv6 BMC Lan IP address.

IPv6 BMC LAN IP Prefix Length

Allows you to input IPv6 BMC Lan IP Prefix Length.

IPv6 BMC LAN Default Gateway

Allows you to input IPv6 BMC Lan Default Gateway.

IPv6 BMC LAN DNS Settings

Allows you to enter IPv6 BMC LAN DNS Settings.

IPv6 BMC LAN Link IP Address

Allows you to enter IPv6 BMC LAN Link IP address.

IPv6 BMC LAN Link IP Prefix Length

Allows you to input IPv6 BMC Lan Link IP Prefix Length.

5.7 Event Logs menu

The Event Logs menu items allow you to change the event log settings and view the system event logs.

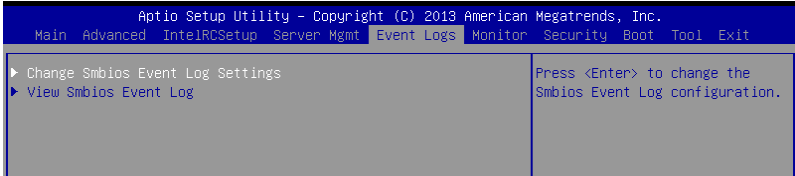

5.7.1 Change Smbios Event Log Settings

Press <Enter> to change the Smbios Event Log configuration.



All values changed here do not take effect until computer is restarted.

Enabling/Disabling Options

Smbios Event Log [Enabled]

Change this to enable or disable all features of Smbios Event Logging during boot.
Configuration options: [Disabled] [Enabled]

Erasing Settings

Erase Event Log [No]

Choose options for erasing Smbios Event Log. Erasing is done prior to any logging activation during reset. Configuration options: [No] [Yes, Next reset] [Yes, Every reset]

When Log is Full [Do Nothing]

Allows you to choose options for reactions to a full Smbios Event Log. Configuration options: [Do Nothing] [Erase Immediately]

Smbios Event Log Standard Settings

Log System Boot Event [Disabled]

Allows you to choose options to enable/disable logging of System boot event. Configuration options: [Enabled] [Disabled]

MECI [1]

Multiple Event Count Increment (MECI). The number of occurrences of a duplicate event that must pass before the multiple-event counter associated with the log entry is updated, specified as a numeric value in the range 1 to 255.

METW [60]

Multiple Event Time Windows (METW). The number of minutes which must pass between duplicate log entries which utilize a multiple-event counter. The value ranges from 0 to 99 minutes.

Custom Option

Log OEM Codes [Enabled]

Enable or disable the logging of EFI Status Codes as OEM Codes (if not already converted to legacy). Configuration options: [Disabled] [Enabled]

Convert OEM Codes [Disabled]

Enable or disable the converting of EFI Status Codes to Standard Smbios Types (Not all may be translated).

Configuration options: [Disabled] [Enabled]

5.7.2 View Smbios Event Log

Press <Enter> to view all smbios event logs.

5.8 Monitor menu

The Monitor menu displays the system temperature/power status, and allows you to change the fan settings.

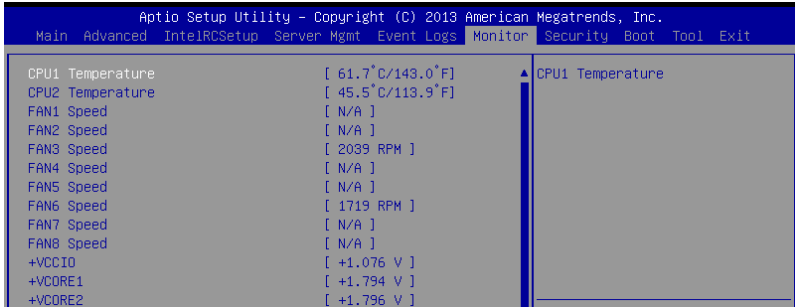

Aptio Setup Utility - Copyright (C) 2013 American Megatrends, Inc.		
Main Advanced IntelRCSetup Server Mgmt Event Logs Monitor Security Boot Tool Exit		
CPU1 Temperature	[61.7°C/143.0°F]	▲ CPU1 Temperature
CPU2 Temperature	[45.5°C/113.9°F]	
FAN1 Speed	[N/A]	
FAN2 Speed	[N/A]	
FAN3 Speed	[2039 RPM]	
FAN4 Speed	[N/A]	
FAN5 Speed	[N/A]	
FAN6 Speed	[1719 RPM]	
FAN7 Speed	[N/A]	
FAN8 Speed	[N/A]	
+VCCIO	[+1.076 V]	
+VCORE1	[+1.794 V]	
+VCORE2	[+1.796 V]	



Scroll down to view the other items.

CPU1/2 Temperature [xxx°C/xxx°F]

The onboard hardware monitor automatically detects and displays the CPU temperatures

FAN1-8 Speed [xxxx RPM] or [N/A]

The onboard hardware monitor automatically detects and displays the speed of CPU fans, front fans, and rear fan in rotations per minute (RPM). If the fan is not connected to the motherboard, the field shows N/A.

+VCCIO, VCORE1/2 Voltage, +VDDQ_AB_CPU1 Voltage, +VDDQ_CD_CPU1 Voltage, +VDDQ_EF_CPU2 Voltage, +VDDQ_GH_CPU2 Voltage, +5VSB Voltage, +5V Voltage, +12V Voltage, +3.3V Voltage, VBAT Voltage, +3.3VSB Voltage

The onboard hardware monitor automatically detects the voltage output through the onboard voltage regulators.

CPU FAN1&2 FRNT FAN1 mode [Generic Mode]

Allows you to configure the ASUS Smart Fan feature that smartly adjusts the fan speeds for more efficient system operation.

Configuration options: [Generic Mode] [High Speed Mode] [Full Speed Mode] [Manual Mode]

Duty % [50]

This item appears only when CPU FAN1&2 FRNT FAN1 mode is set to [Manual Mode].

This item allows you to configure the fan duty setting from 10% to 100%.

FAN2&3/1&4/6&7/5&8 [Generic Speed]

Allows you to configure the ASUS Smart Fan feature that smartly adjusts the fan speeds for more efficient system operation.

Configuration options: [Generic Speed] [High Speed] [Full Speed] [Manual]

5.9 Security menu

This menu allows a new password to be created or a current password to be changed. The menu also enables or disables the Secure Boot state and lets the user configure the System Mode state.

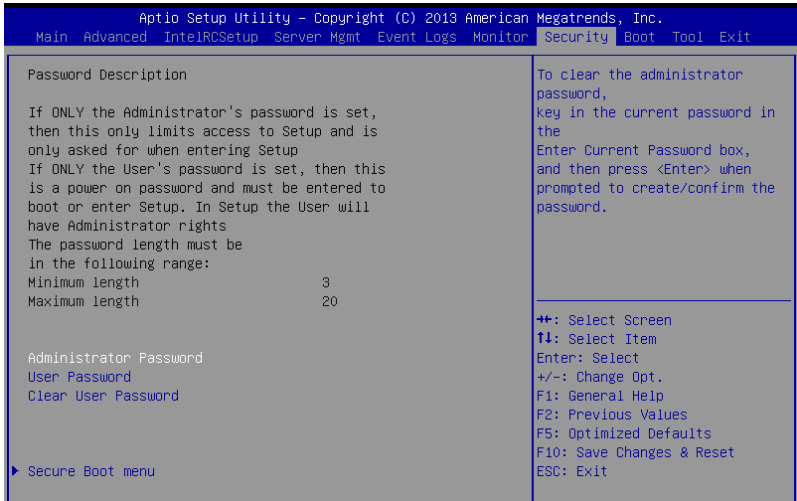

Administrator Password

To set an administrator password:

1. Select the Administrator Password item and press <Enter>.
2. From the Create New Password box, key in a password, then press <Enter>.
3. Confirm the password when prompted.

To change an administrator password:

1. Select the Administrator Password item and press <Enter>.
2. From the Enter Current Password box, key in the current password, then press <Enter>.
3. From the Create New Password box, key in a new password, then press <Enter>.
4. Confirm the password when prompted.



To clear the administrator password, follow the same steps as in changing an administrator password, but press <Enter> when prompted to create/confirm the password.

User Password

To set a user password:

1. Select the User Password item and press <Enter>.
2. From the Create New Password box, key in a password, then press <Enter>.
3. Confirm the password when prompted.

To change a user password:

1. Select the User Password item and press <Enter>.
2. From the Enter Current Password box, key in the current password, then press <Enter>.
3. From the Create New Password box, key in a new password, then press <Enter>.
4. Confirm the password when prompted.

To clear a user password:

1. Select the Clear User Password item and press <Enter>.
2. Select **Yes** from the Warning message window then press <Enter>.

Secure Boot Menu

This item allows you to customize the Secure Boot settings.

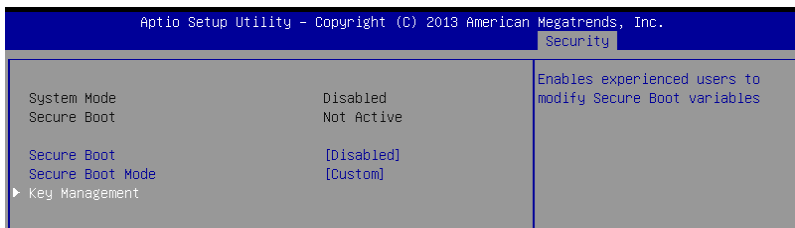

Secure Boot [Disabled]

Secure Boot can be enabled if the system is running in User mode with enrolled platform Key (EPK) or if the CSM function is disabled.

Configuration options: [Disabled] [Enabled]

Secure Boot Mode [Custom]

Allows you to set the Secure Boot selector.

Configuration options: [Custom] [Standard]

Key Management

This item only appears when the item Secure Boot Mode is set to [Custom]. The Key Management item allows you to modify Secure Boot variables and set Key Management page.

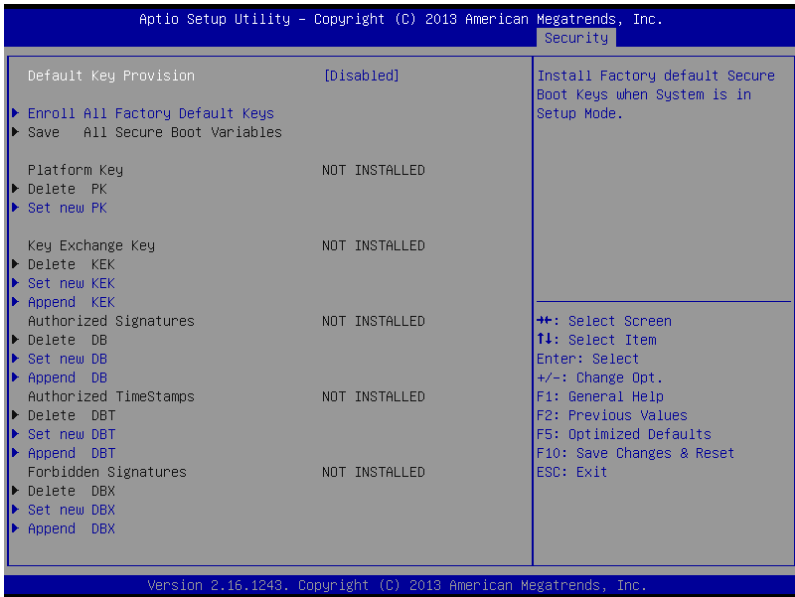

Default Key Provision [Disabled]

Configuration options: [Disabled] [Enabled]

Enroll All Factory Default Keys

This item will ask you if you want to Install Factory Default secure keys. Select Yes if you want to load the default secure keys, otherwise select No.

Save All Secure Boot Variables

This item will ask you if you want to save all secure boot variables. Select Yes if you want to save all secure boot variables, otherwise select No.

Platform Key (PK)/ Key Exchange Key (KEK)/ Authorized Signatures (DB)/ Authorized TimeStamps (DBT)/ Forbidden Signatures (DBX)

Configuration options: [Delete] [Set New] [Append]

5.10 Boot menu

The Boot menu items allow you to change the system boot options.

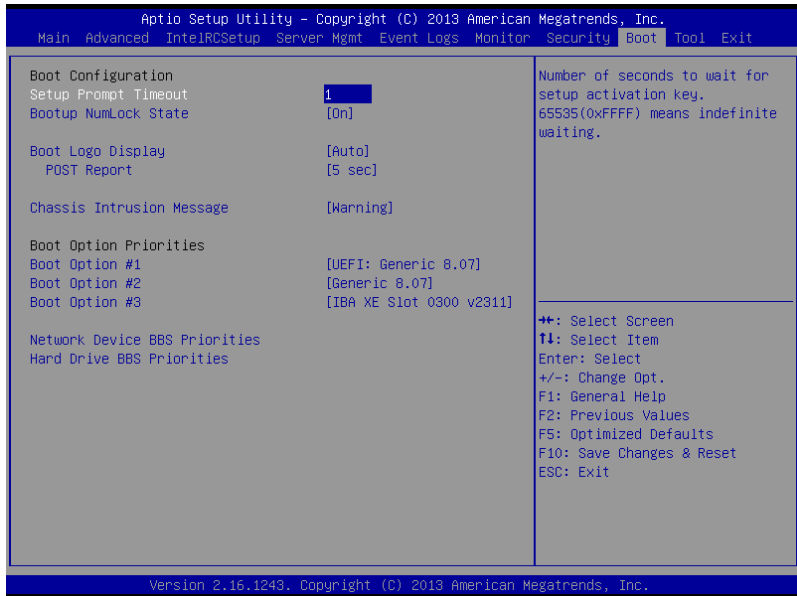

Setup Prompt Timeout [xx]

Use the <+> and <-> keys to adjust the number of seconds to wait for setup activation key.

Bootup NumLock State [On]

Allows you to select the power-on state for the NumLock.

Configuration options: [Off] [On]

Boot Logo Display [Auto]

Allows you to enable or disable the full screen logo display feature.

Configuration options: [Auto] [Full Screen] [Disabled]

POST Report [5 sec]

Allows you to set the desired POST Report waiting time from 1 to 10 seconds.

Configuration options: [1 sec] ~ [10 sec] [Until Press ESC]

Chassis Intrusion [Warning]

Allows you to set an action when chassis intrusion has occurred.

Configuration options: [Warning] [Halt]

Boot Option Priorities

These items specify the boot device priority sequence from the available devices. The number of device items that appears on the screen depends on the number of devices installed in the system.



- To select the boot device during system startup, press <F8> when ASUS Logo appears.
- To access Windows OS in Safe Mode, please press <F8> after POST.

Set the booting order of network devices.

Boot Option #1/#2 [SATA P2: ASUS ...]

Configuration options: [SATA P2: ASUS ...] [SATA P3: WDC WD80...]
[AMI Virtual Floppy...][IBA GE Slot 0700 v...]

CD/DVD ROM Drive BBS Priorities

Hard Drive BBS Priorities / Network Device BBS Priorities

These items appear only when you connect SATA ODD or hard drive to the SATA ports and allow you to set the booting order of the SATA devices.

5.11 Tool menu

The Tool menu items allow you to configure options for special functions. Select an item then press <Enter> to display the submenu.

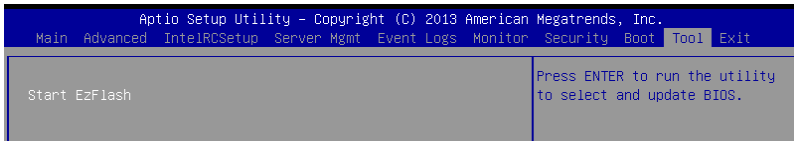

ASUS EZ Flash

Allows you to run ASUS EZ Flash BIOS ROM Utility when you press <Enter>. Refer to the ASUS EZ Flash Utility section for details.

5.12 Exit menu

The Exit menu items allow you to save or discard your changes to the BIOS items.

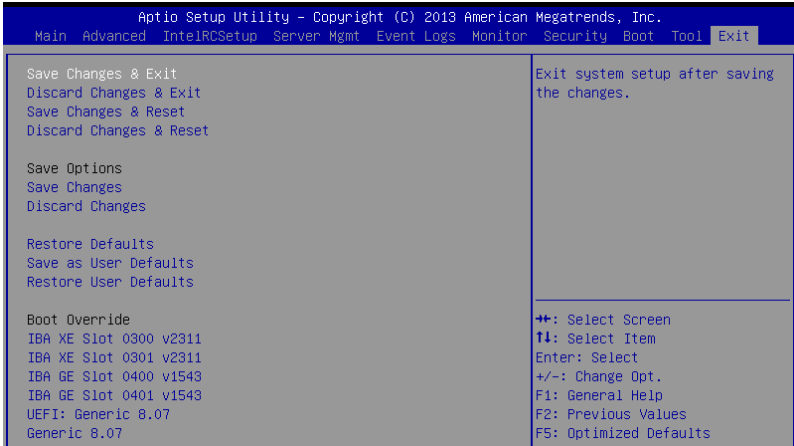

Pressing <Esc> does not immediately exit this menu. Select one of the options from this menu or <F10> from the legend bar to exit.

Save Changes & Reset

Exit System setup after saving the changes.

Discard Changes & Exit

Exit System setup without saving any changes.

Save Changes & Reset

Reset the system setup after saving the changes.

Discard Changes & Reset

Reset system setup without saving any changes.

Save Options

Save Changes

Save changes done so far to any of the setup options.

Discard Changes

Discard changes done so far to any of the setup options.

Restore Defaults

Restore/load default values for all the setup options.

Save as User Defaults

Save the changes done so far as User Defaults.

Restore User Defaults

Restore the User Defaults to all the setup options.

Boot Override

These items displays the available devices. The device items that appears on the screen depends on the number of devices installed in the system. Click an item to start booting from the selected device.

Launch EFI Shell from filesystem device

Attempts to launch EFI Shell application (shellx64.efi) from one of the available filesystem devices.

RAID Configuration

6

This chapter provides instructions for setting up, creating, and configuring RAID sets using the available utilities.

6.1 Setting up RAID

The motherboard supports the following SATA RAID solutions:

- **LSI MegaRAID software RAID Configuration Utility** with RAID 0, RAID 1, and RAID 10 support (for both Linux and Windows OS).
- **Intel® Rapid Storage Technology enterprise Option ROM Utility** with RAID 0, RAID 1, RAID 10, and RAID 5 support (for Windows OS only).

6.1.1 RAID definitions

RAID 0 (*Data striping*) optimizes two identical hard disk drives to read and write data in parallel, interleaved stacks. Two hard disks perform the same work as a single drive but at a sustained data transfer rate, double that of a single disk alone, thus improving data access and storage. Use of two new identical hard disk drives is required for this setup.

RAID 1 (*Data mirroring*) copies and maintains an identical image of data from one drive to a second drive. If one drive fails, the disk array management software directs all applications to the surviving drive as it contains a complete copy of the data in the other drive. This RAID configuration provides data protection and increases fault tolerance to the entire system. Use two new drives or use an existing drive and a new drive for this setup. The new drive must be of the same size or larger than the existing drive.

RAID 10 is data striping and data mirroring combined without parity (redundancy data) having to be calculated and written. With the RAID 10 configuration you get all the benefits of both RAID 0 and RAID 1 configurations. Use four new hard disk drives or use an existing drive and three new drives for this setup.

RAID 5 stripes both data and parity information across three or more hard disk drives. Among the advantages of RAID 5 configuration include better HDD performance, fault tolerance, and higher storage capacity. The RAID 5 configuration is best suited for transaction processing, relational database applications, enterprise resource planning, and other business systems. Use a minimum of three identical hard disk drives for this setup.



-
- If you want to boot the system from a hard disk drive included in a created RAID set, copy first the RAID driver from the support DVD to a floppy disk before you install an operating system to the selected hard disk drive.
 - Please refer to chapter 2 for how to select the RAID configuration utility. Move the jumper to choose between LSI MegaRAID and Intel® Rapid RAID.
-

6.1.2 Installing hard disk drives

The motherboard supports Serial ATA for RAID set configuration. For optimal performance, install identical drives of the same model and capacity when creating a disk array.

To install the SATA hard disks for RAID configuration:

1. Install the SATA hard disks into the drive bays following the instructions in the system user guide.
2. Connect a SATA signal cable to the signal connector at the back of each drive and to the SATA connector on the motherboard.
3. Connect a SATA power cable to the power connector on each drive.

6.1.3 Setting the RAID item in BIOS

You must set the RAID item in the BIOS Setup before you can create a RAID set from SATA hard disk drives attached to the SATA connectors supported by Intel® C612 chipset.

To do this:

1. Enter the BIOS Setup during POST.
2. Go to the **Advanced Menu > PCH SATA Configuration**, then press <Enter>.
3. Set **SATA Mode** to [RAID Mode]
4. Press <F10> to save your changes and exit the BIOS Setup.



Refer to Chapter 4 for details on entering and navigating through the BIOS Setup.

6.1.4 RAID configuration utilities

Depending on the RAID connectors that you use, you can create a RAID set using the utilities embedded in each RAID controller. For example, use the **LSI MegaRAID Software Configuration Utility** or the **Intel® Rapid Storage Technology** if you installed Serial ATA hard disk drives on the Serial ATA connectors supported by the Intel® C612 chipset.

Refer to the succeeding section for details on how to use the RAID configuration utility.

6.2 LSI Software RAID Configuration Utility

The LSI MegaRAID software RAID configuration utility allows you to create RAID 0, RAID 1, or RAID 10 set(s) from SATA hard disk drives connected to the SATA connectors supported by the motherboard southbridge chip.

To enter the LSI MegaRAID software RAID configuration utility:

1. Turn on the system after installing all the SATA hard disk drives.
2. During POST, the LSI MegaRAID software RAID configuration utility automatically detects the installed SATA hard disk drives and displays any existing RAID set(s). Press <Ctrl> + <M> to enter the utility.

```
LSI MegaRAID Software RAID BIOS Version A.10 09231523R
LSI SATA RAID Found at PCI Bus No:00 Dev No:1F
Device present at Port 0      ST3160812AS      152114MB
Device present at Port 1      ST3160812AS      152114MB
Device present at Port 2      ST3160812AS      152114MB
Device present at Port 3      ST3160812AS      152114MB
Press Ctrl-M or Enter to run LSI Software RAID Setup Utility.
```



- The LSI MegaRAID software RAID configuration utility automatically configures to RAID 1 when the SATA to RAID Mode is enabled.
- The RAID setup screens shown in this section are for reference only and may not exactly match the items on your screen due to the controller version difference.
- When you create RAID sets with the LSI MegaRAID software RAID configuration utility, the boot priority of the SATA optical drive has to be manually adjusted. Otherwise, the system will not boot from the connected SATA ODD.

3. The utility main window appears. Use the arrow keys to select an option from the **Management Menu** and then press <Enter>. Refer to the Management Menu descriptions on the next page.

At the bottom of the screen is the legend box. The keys on the legend box allow you to navigate through the setup menu options or execute commands. The keys on the legend box vary according to the menu level.

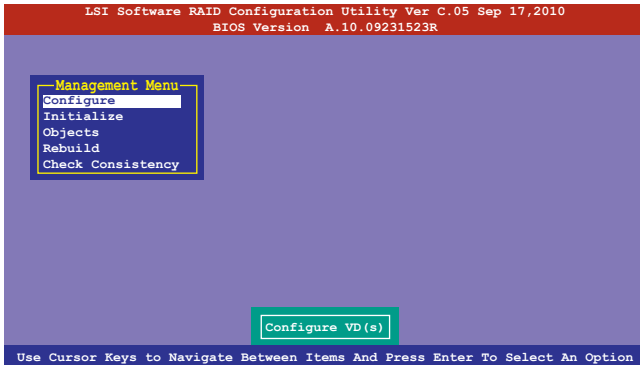

Menu	Description
Configure	Allows you to create RAID 0, RAID 1 or RAID 10 set using the Easy Configuration or the New Configuration command. This menu also allows you to view, add, or clear RAID configurations or select the boot drive
Initialize	Allows you to initialize the virtual drives of a created RAID set
Objects	Allows you to initialize virtual drives or change the virtual drive parameters
Rebuild	Allows you to rebuild failed drives
Check Consistency	Allows you to check the data consistency of the virtual drives of a created RAID set

6.2.1 Creating a RAID set

The LSI Software RAID Configuration Utility allows you to create a RAID 0, RAID 1, or RAID 10 set using two types of configurations: **Easy** and **New**.

In **Easy Configuration**, the virtual drive parameters are set automatically.

In **New Configuration**, you manually set the virtual drive parameters.

Using Easy Configuration

To create a RAID set using the **Easy Configuration** option:

1. From the **Management Menu**, select **Configure > Easy Configuration**, and then press <Enter>.

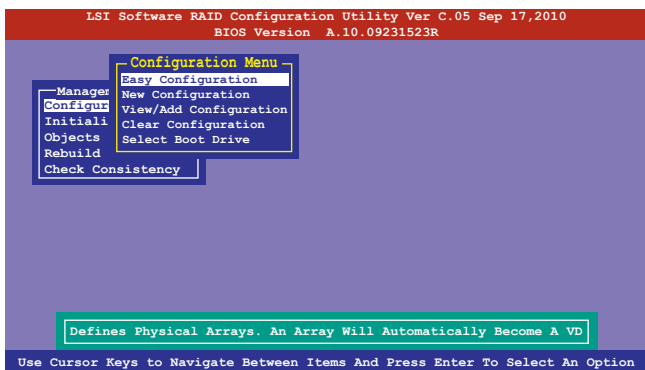

- The **ARRAY SELECTION MENU** displays the available drives connected to the SATA ports. Use the up/down arrow keys to select the drives you want to include in the RAID set, and then press <Space>. When selected, the drive indicator changes from **READY** to **ONLIN A[X]-[Y]**, where X is the array number, and Y is the drive number.

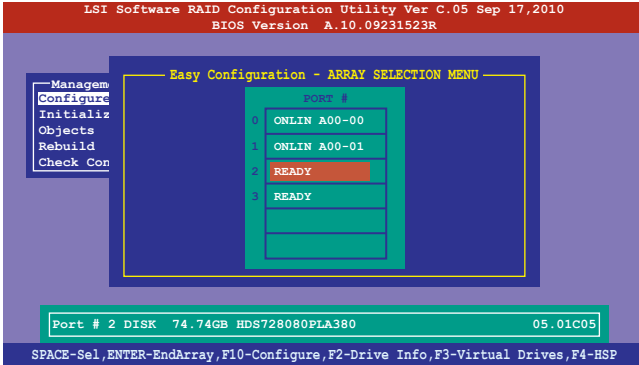

- The information of the selected hard disk drive displays at the bottom of the screen.
- You need at least two identical hard disk drives when creating a RAID 1 set.
- You need at least four identical hard disk drives when creating a RAID 10 set.

- Select all the drives required for the RAID set, and then press <F10> to configure array setting.
- Press <Space> to select the configurable array.

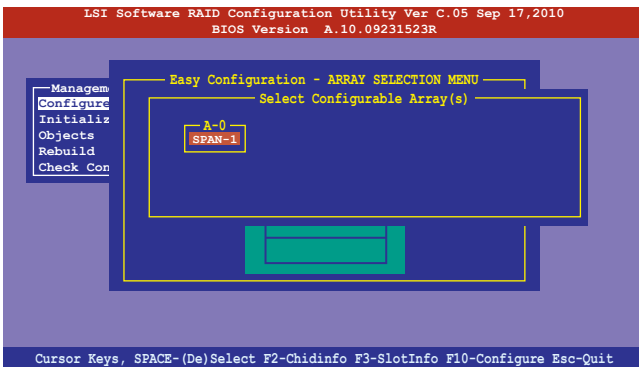

- Press <F10> again, the virtual drive information appears including a **Virtual Drive** menu that allows you to change the virtual drive parameters.

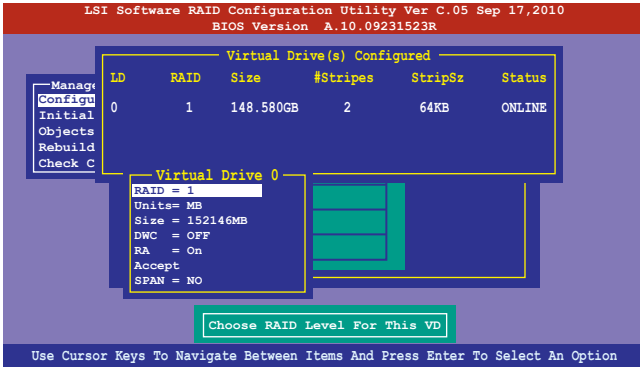

- Select **RAID** from the **Virtual Drive** sub-menu, and then press <Enter>.
- Select the **RAID level** from the menu, and then press <Enter>.

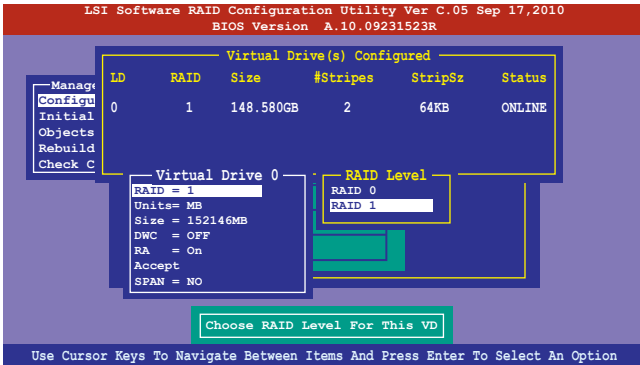

8. Select **Units** from the **Virtual Drive** sub-menu, and then press <Enter>.
9. Select the units for virtual drive size from the menu, and then press <Enter>.

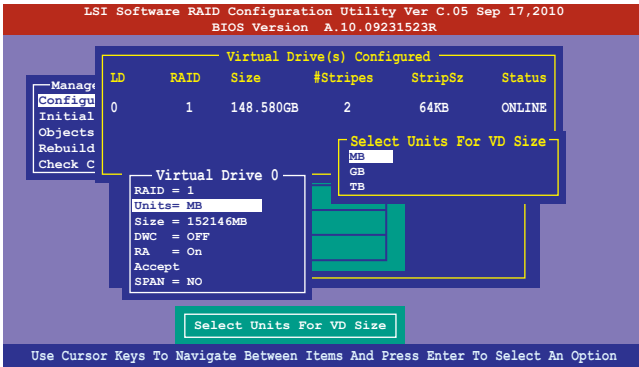

10. When creating a **RAID 1** or a **RAID 10** set, select **DWC** from the **Virtual Drive** menu, and then press <Enter>.

When creating a **RAID 0** set, proceed to step 12.

11. Select **On** to enable the **Disk Write Cache** setting, and then press <Enter>.

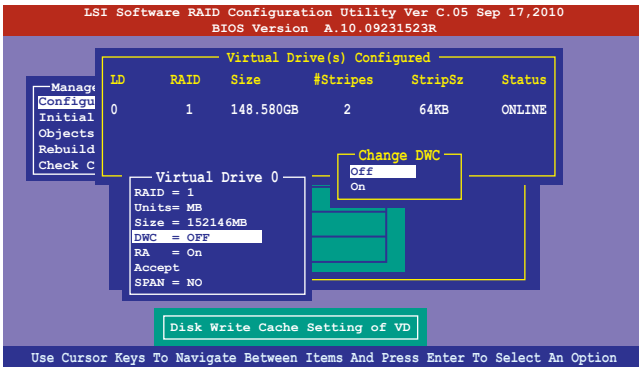

Enabling DWC can improve the performance, but with the risk of data loss.

12. When finished setting the selected virtual drive configuration, select **Accept** from the menu, and then press <Enter>.

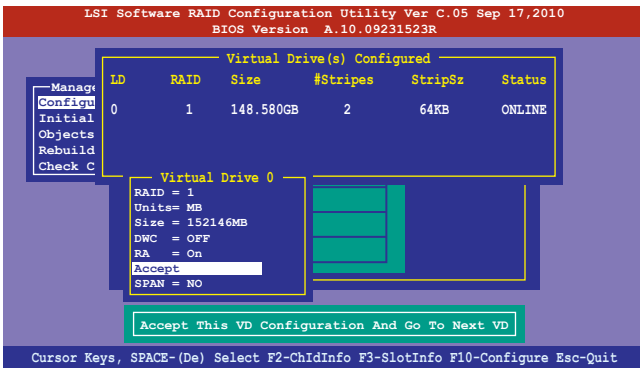

13. Follow step 2 to 12 to configure additional virtual drives.
14. Press <Esc> to finish RAID configuration. When prompted to save configuration, select **Yes** from the menu, and then press <Enter>.

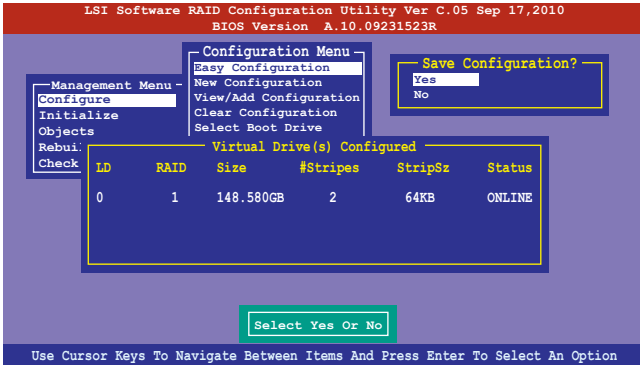

Using New Configuration



When a RAID set already exists, using the **New Configuration** command erases the existing RAID configuration data. If you do not want to delete the existing RAID set, use the **View/Add Configuration** command to view or create another RAID configuration.

To create a RAID set using the **New Configuration** option

1. From the **Management Menu**, select **Configure > New Configuration**, and then press <Enter>.

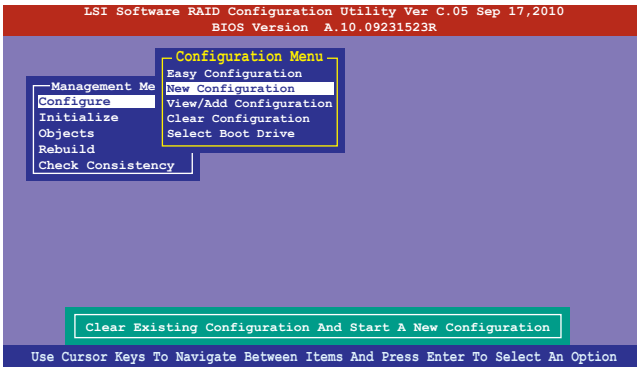

2. Follow step 2 to 9 of the previous section: **Using Easy Configuration**.
3. Select **Size** from the **Virtual Drive** menu, and then press <Enter>.
4. Key-in the desired virtual drive size, and then press <Enter>.

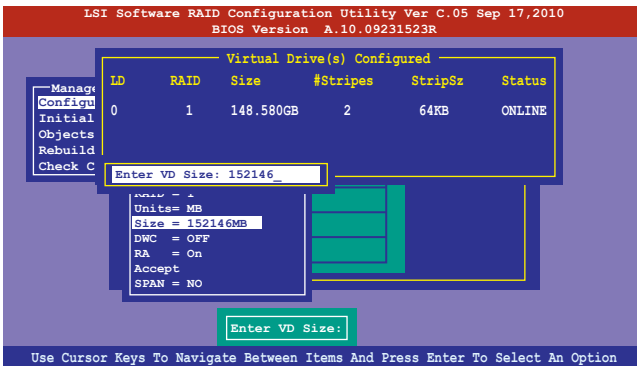

5. Follow step 10 to 14 of the previous section: **Using Easy Configuration** to create the RAID set.

6.2.2 Adding or viewing a RAID configuration

You can add a new RAID configuration or view an existing configuration using the **View/Add Configuration** command.

Adding a new RAID configuration

To add a new RAID configuration:

1. From the **Management Menu**, select **Configure > View/Add Configuration**, and then press <Enter>.

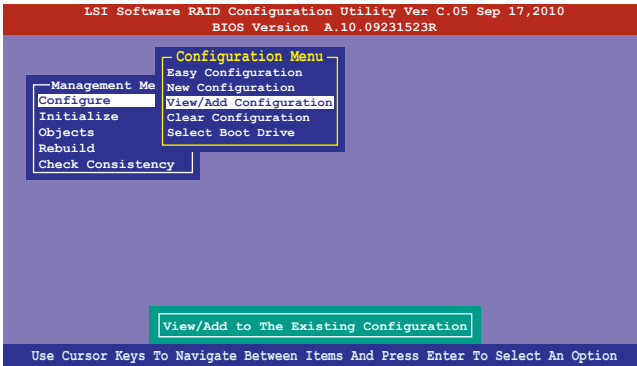

2. The **ARRAY SELECTION MENU** displays the available drives connected to the SATA ports. Select the drive(s) you want to include in the RAID set, then press <Space>. When selected, the drive indicator changes from **READY** to **ONLIN A[X]-[Y]**, where X is the array number, and Y is the drive number.

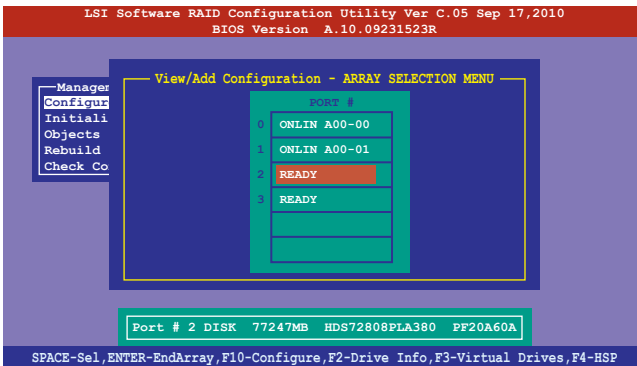

The information of the selected hard disk drive displays at the bottom of the screen.

3. Follow step 3 to 12 of section 6.2.1 **Creating a RAID set: Using Easy Configuration** to add a new RAID set.

6.2.3 Initializing the virtual drives

After creating the RAID set(s), you must initialize the virtual drives. You may initialize the virtual drives of a RAID set(s) using the **Initialize** or **Objects** command on the **Management Menu**.

Using the Initialize command

To initialize the virtual drive using the Initialize command

1. From the **Management Menu**, select **Initialize**, and then press <Enter>.

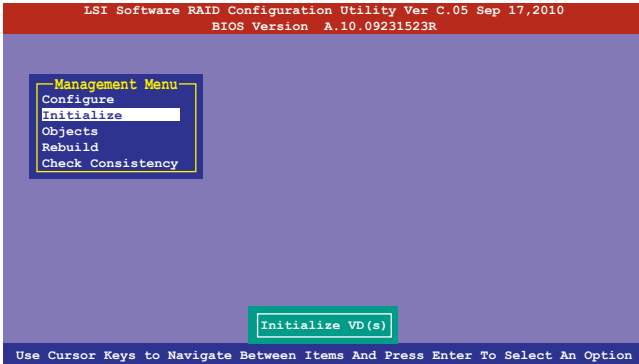

2. The screen displays the available RAID set(s) and prompts you to select the virtual drive to initialize. Use the arrow keys to select the virtual drive from the **Virtual Drive** selection, and then press <Space>.

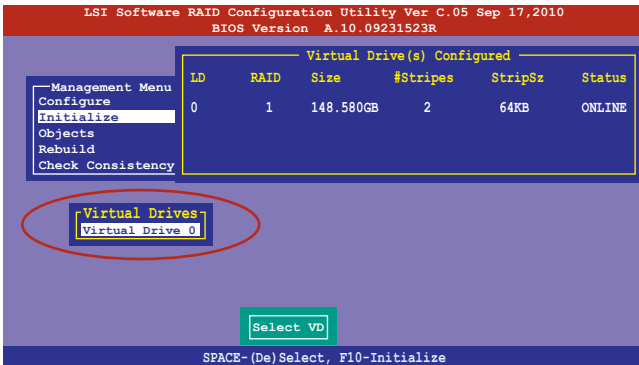

- Press <F10> to start initialization. When prompted, select **Yes** from the **Initialize?** dialog box, and then press <Enter>.

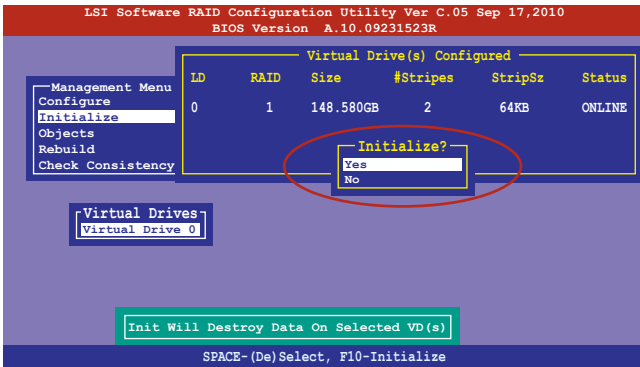

Initializing a virtual drive erases all data on the drive.

- A progress bar appears on screen. If desired, press <Esc> to abort initialization. When initialization is completed, press <Esc>.

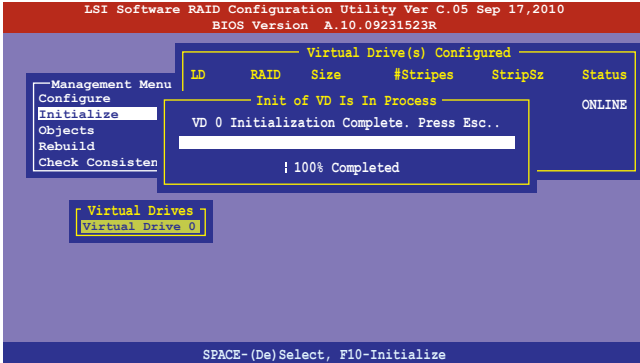

Using the Objects command

To initialize the virtual drives using the **Objects** command

1. From the **Management Menu**, select **Objects > Virtual Drive**, and then press **<Enter>**.

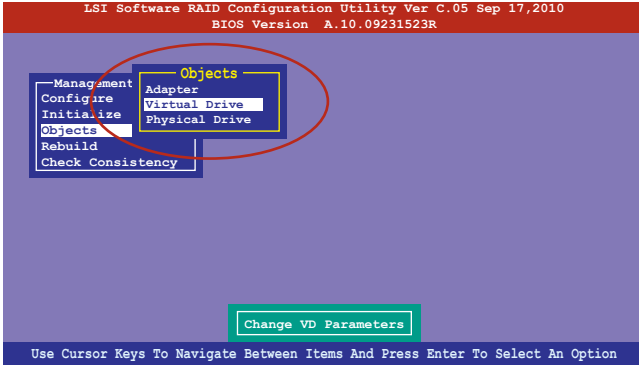

2. Select the virtual drive to initialize from the **Virtual Drives** sub-menu, and then press **<Enter>**.

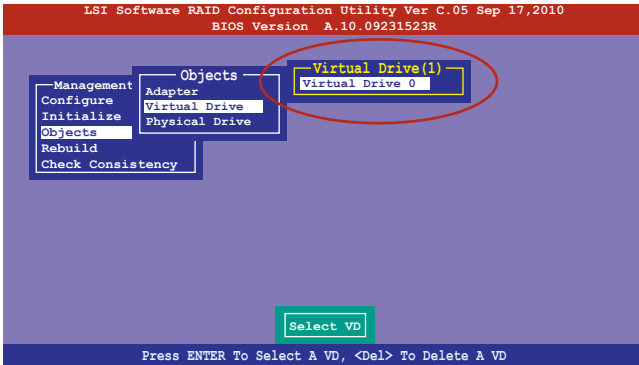

3. Select **Initialize** from the pop-up menu, and then press <Enter> to start initialization.

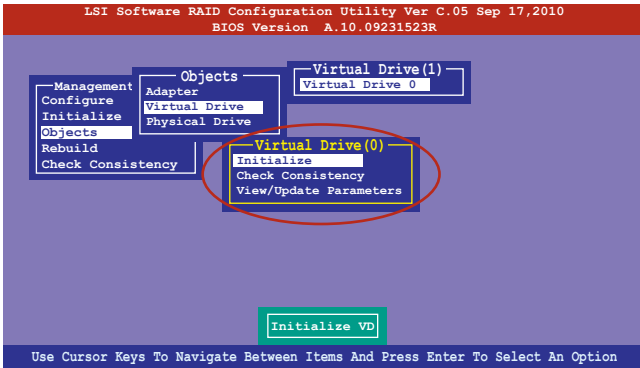

4. When prompted, press the <Space> to select **Yes** from the **Initialize?** dialog box, and then press <Enter>.

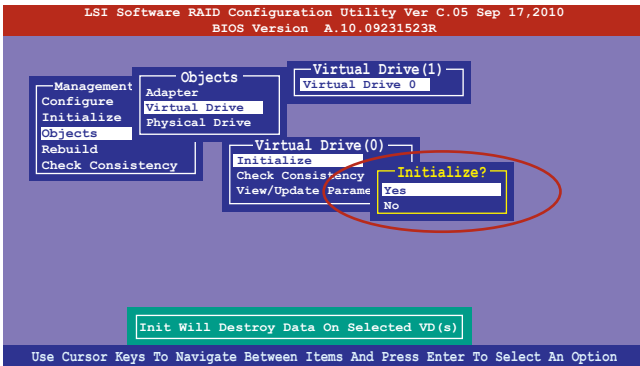

5. A progress bar appears on screen. If desired, press <Esc> to abort initialization. When initialization is completed, press <Esc>.

6.2.4 Rebuilding failed drives

You can manually rebuild failed hard disk drives using the **Rebuild** command in the **Management Menu**.

To rebuild a failed hard disk drive

1. From the **Management Menu**, select **Rebuild**, and then press <Enter>.

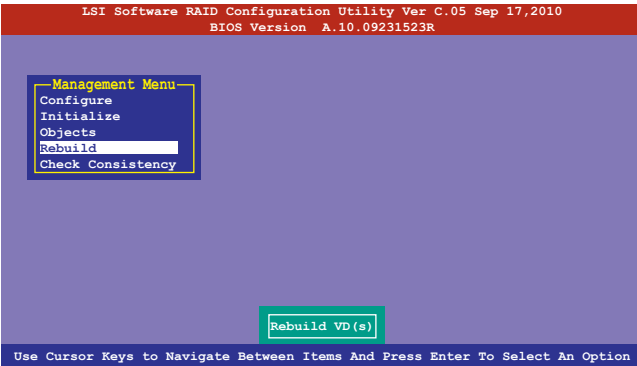

2. The **PHYSICAL DRIVES SELECTION MENU** displays the available drives connected to the SATA ports. Select the drive you want to rebuild, and then press <Space>.

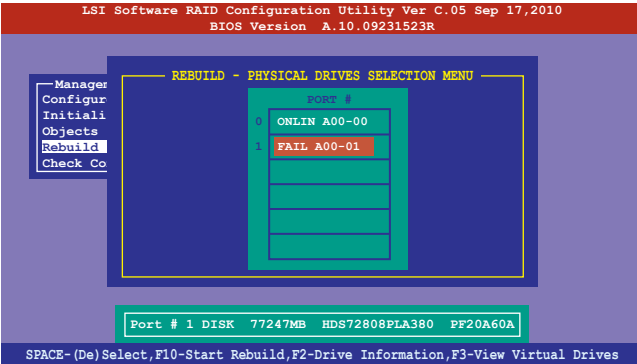

3. After selecting the drive to rebuild, press <F10>. When prompted, press <Y> to rebuild the drive.

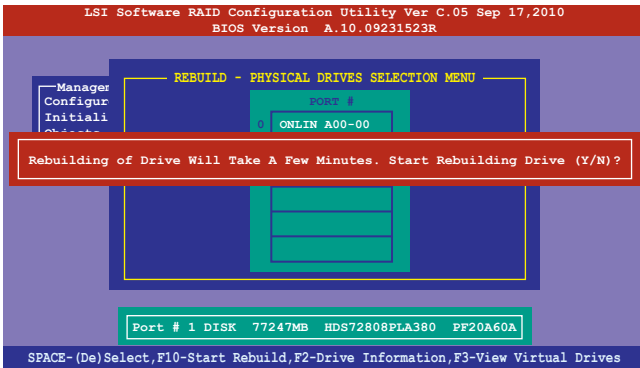

4. When rebuild is complete, press any key to continue.

6.2.5 Checking the drives for data consistency

You can check and verify the accuracy of data redundancy in the selected virtual drive. The utility can automatically detect and/or detect and correct any differences in data redundancy depending on the selected option in the **Objects > Adapter** menu.



The **Check Consistency** command is available only for virtual drives included in a RAID 1 or RAID 10 set.

Using the Check Consistency Command

To check data consistency using the **Check Consistency** command

1. From the **Management Menu**, select **Check Consistency**, and then press <Enter>.

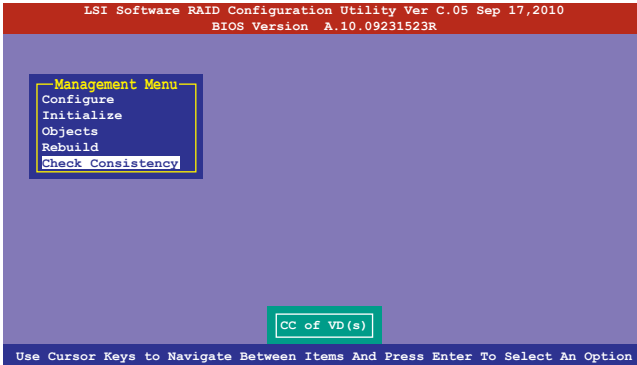

2. The screen displays the available RAID set(s) and prompts you to select the virtual drive to check. Press <Space> to select the virtual drive from the **Virtual Drive** sub-menu, and then press <F10>.

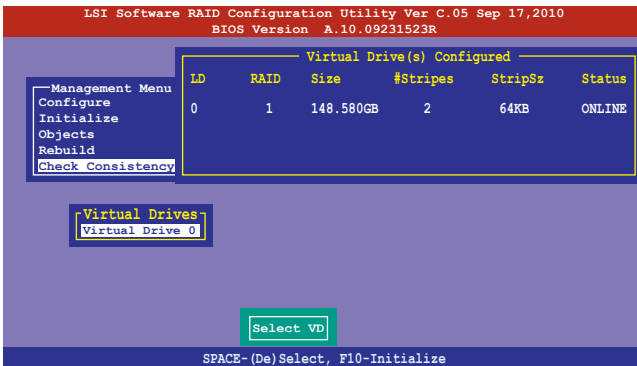

- When prompted, use the arrow keys to select **Yes** from the **Consistency Check?** dialog box, and then press <Enter>.

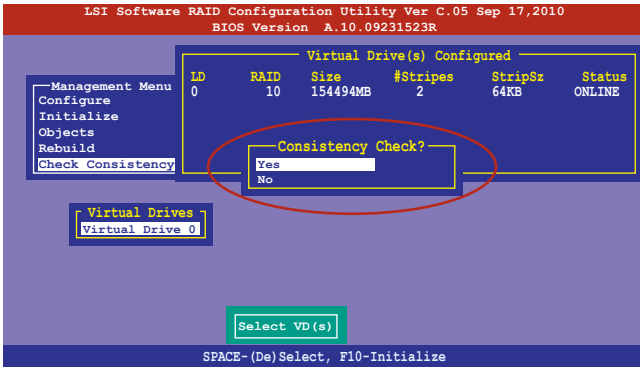

A progress bar appears on screen.

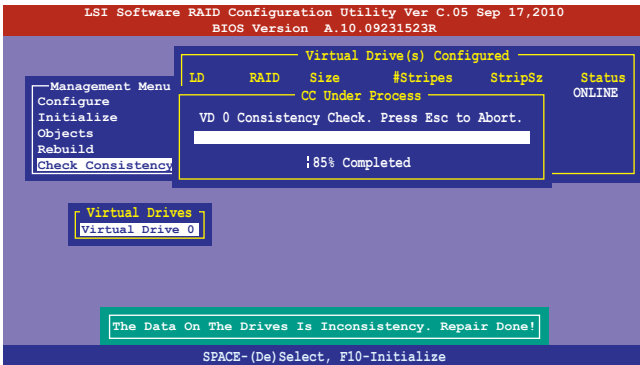

- While checking the disk consistency, press <Esc> to display the following options.
 - Stop** - Stops the consistency check. The utility stores the percentage of disk checked, and when you restart checking, it continues from the last percentage completed rather than from zero percent.
 - Continue** - Continues the consistency check.
 - Abort** - Aborts the consistency check. When you restart checking, it continues from zero percent.
- When checking is complete, press any key to continue.

Using the Objects command

To check data consistency using the **Objects** command

1. From the **Management Menu**, select **Objects**, and then select **Virtual Drive** from the sub-menu.
2. Use the arrow keys to select the virtual drive you want to check, and then press <Enter>.
3. Select **Check Consistency** from the pop-up menu, and then press <Enter>.
4. When prompted, use the arrow keys to select **Yes** from the dialog box to check the drive.
5. When checking is complete, press any key to continue.

6.2.6 Deleting a RAID configuration

To delete a RAID configuration

1. From the **Management Menu**, select **Configure** > **Clear Configuration**, and then press <Enter>.

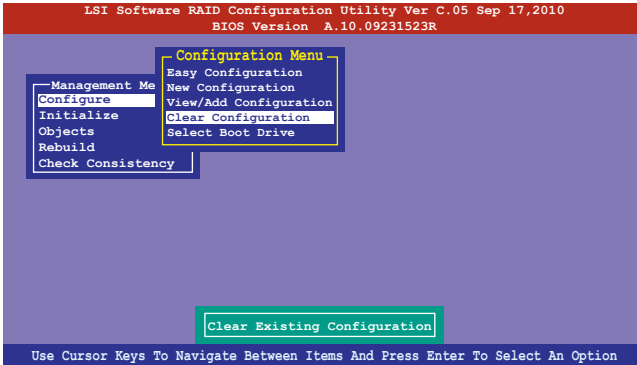

2. When prompted, use the arrow keys to select **Yes** from the **Clear Configuration?** dialog box, and then press <Enter>.

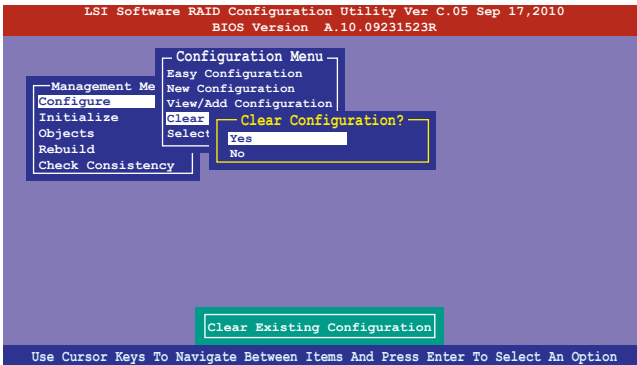

The utility clears all the current array(s).

3. Press any key to continue.

6.2.7 Selecting the boot drive from a RAID set

You must have created a new RAID configuration before you can select the boot drive from a RAID set. See section 6.2.1 **Creating a RAID set: Using New Configuration** for details.

To select the boot drive from a RAID set

1. From the **Management Menu**, select **Configure > Select Boot Drive**, and then press <Enter>.

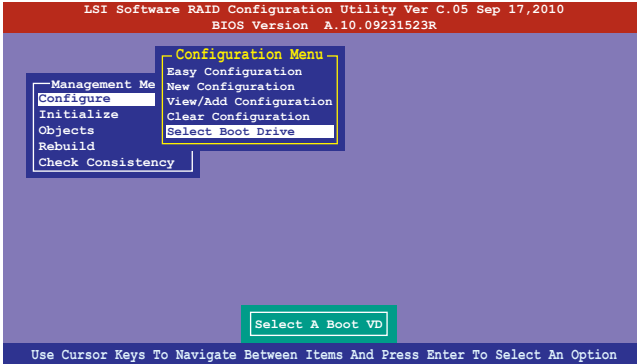

2. When prompted, use the arrow keys to select the bootable virtual drive from the list, then press <Enter>.

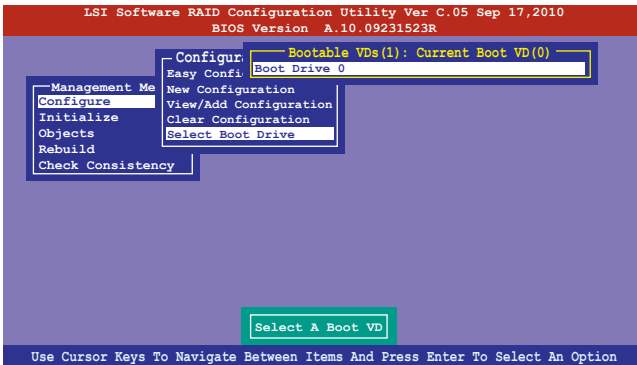

3. The virtual drive is selected as boot drive. Press any key to continue.

6.2.8 Enabling WriteCache

You may manually enable the RAID controller's WriteCache option after creating a RAID set to improve the data transmission performance.



When you enable WriteCache, you may lose data when a power interruption occurs while transmitting or exchanging data among the drives.



The WriteCache function is recommended for RAID 1 and RAID 10 sets.

To enable WriteCache

1. From the **Management Menu**, select **Objects > Adapter**, select an existing adapter, and then press <Enter> to display the adapter properties.
2. Select **Disk WC**, and then press <Enter> to turn on the option.

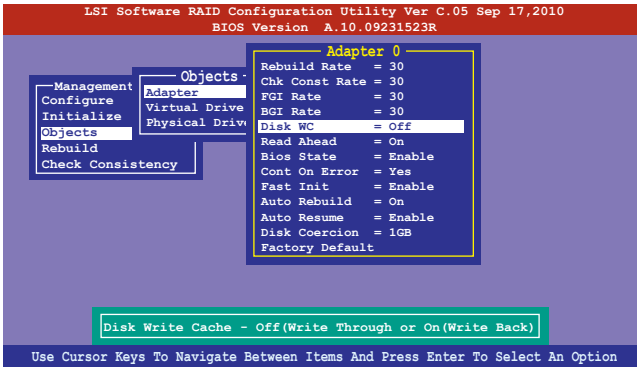

3. From the **Management Menu**, select **Objects > Virtual Drive**, select an existing adapter and press <Enter>. Select **View/Update Parameters** and press <Enter> to display the adapter properties.
4. Select **Disk WC**, and then press <Enter> to turn on the option.

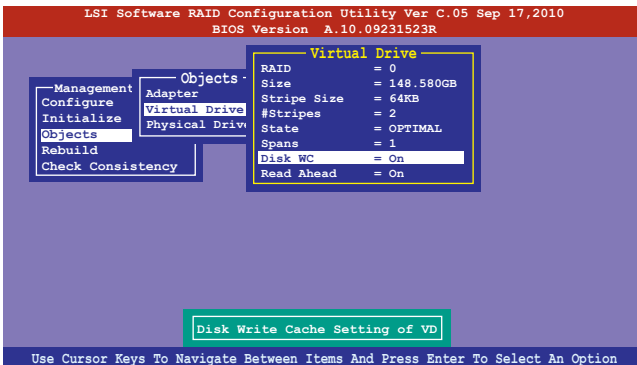

5. When finished, press any key to continue.

6.3 Intel® Rapid Storage Technology enterprise SATA/SSATA Option ROM Utility

The Intel® Rapid Storage Technology enterprise SATA/SSATA Option ROM utility allows you to create RAID 0, RAID 1, RAID 10 (RAID 1+0), and RAID 5 set from Serial ATA hard disk drives that are connected to the Serial ATA connectors supported by the Southbridge.



Before you proceed, ensure that you have installed the Serial ATA hard disk drives, have set the correct jumper settings of the motherboard, and have set the correct SATA mode in the BIOS setup. You can refer to the **Installing hard disk drives**, **Setting Jumpers**, and **Setting the RAID mode sections in BIOS** for more information.

To launch the Intel® Rapid Storage Technology enterprise SATA/SSATA Option ROM utility:

1. Turn on the system.
2. During POST, press <Ctrl>+<I> to display the utility main menu.

```
Intel(R) Rapid Storage Technology enterprise - SATA Option ROM - 3.6.0.1023
Copyright(C) 2003-12 Intel Corporation. All Rights Reserved.

[ MAIN MENU ]
1. Create RAID Volume          3. Reset Disks to Non-RAID
2. Delete RAID Volume         4. Exit

[ DISK/VOLUME INFORMATION ]

RAID Volumes:
None defined.

Physical Disks:
ID  Drive Model      Serial #          Size   Type/Status (Vol ID)
0   ST3300656SS      HWS0000991753TR 279.3GB Non-RAID Disk
1   ST3300656SS      37VN00009846RAJ1 279.3GB Non-RAID Disk
2   ST3300656SS      397600009846UEDY 279.3GB Non-RAID Disk
3   ST3300656SS      GWC50000991756G6 279.3GB Non-RAID Disk

[↑↓]-Select      [ESC]-Exit      [ENTER]-Select Menu
```

The navigation keys at the bottom of the screen allow you to move through the menus and select the menu options.



The RAID BIOS setup screens shown in this section are for reference only and may not exactly match the items on your screen.

6.3.1 Creating a RAID set

To create a RAID set:

1. From the utility main menu, select **1. Create RAID Volume** and press <Enter>.
2. Key in a name for the RAID set and press <Enter>.

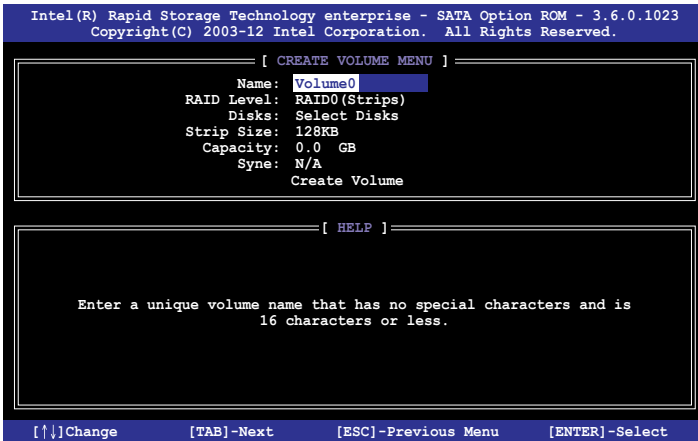

3. Press the up/down arrow keys to select a RAID Level that you wish to create then press <Enter>.
4. From the **Disks** item field, press <Enter> to select the hard disk drives that you want to include in the RAID set.

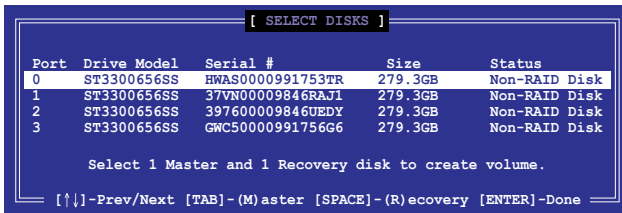

5. Use the up/down arrow keys to move the selection bar then press <Space> to select a disk. A small triangle before the Port number marks the selected drive. Press <Enter> when you are done.

- Use the up/down arrow keys to select the stripe size for the RAID array (for RAID 0, 10 and 5 only) then press <Enter>. The available stripe size values range from 4 KB to 128 KB. The following are typical values:
RAID 0: 128KB
RAID 10: 64KB
RAID 5: 64KB



We recommend a lower stripe size for server systems, and a higher stripe size for multimedia computer systems used mainly for audio and video editing.

- In the **Capacity** field item, key in the RAID volume capacity that you want to use and press <Enter>. The default value field indicates the maximum allowed capacity.
- Press <Enter> to start creating the RAID volume.
- From the following warning message, press <Y> to create the RAID volume and return to the main menu, or press <N> to go back to the **CREATE VOLUME** menu.

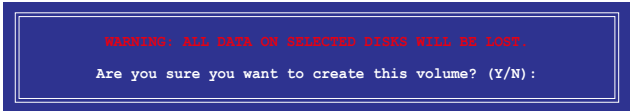

6.3.2 Deleting a RAID set



Take caution when deleting a RAID set. You will lose all data on the hard disk drives when you delete a RAID set.

To delete a RAID set:

1. From the utility main menu, select **2. Delete RAID Volume** and press <Enter>.
2. From the Delete Volume Menu, press the up/down arrow keys to select the RAID set you want to delete then press .

```
Intel(R) Rapid Storage Technology enterprise - SATA Option ROM - 3.6.0.1023
Copyright(C) 2003-12 Intel Corporation. All Rights Reserved.

[ DELETE VOLUME MENU ]

Name      Level      Drives   Capacity  Status   Bootable
Volume0   RAID0 (Stripe)  2        298.0GB   Normal   Yes

[ HELP ]

Deleting a volume will reset the disks to non-RAID

WARNING: ALL DISK DATA WILL BE DELETED.
(This does not apply to Recovery volumes)

[↑/↓]-Select      [ESC]-Previous Menu      [DEL]-Delete Volume
```

3. Press <Y> to confirm deletion of the selected RAID set and return to the utility main menu, or press <N> to return to the **DELETE VOLUME** menu.

```
[ DELETE VOLUME VERIFICATION ]

ALL DATA IN THIS VOLUME WILL BE LOST!
(This does not apply to Recovery volumes)

Are you sure you want to delete volume "Volume0"? (Y/N):
```

6.3.3 Resetting disks to Non-RAID



Take caution before you reset a RAID volume hard disk drive to non-RAID. Resetting a RAID volume hard disk drive deletes all internal RAID structure on the drive.

To reset a RAID set:

1. From the utility main menu, select **3. Reset Disks to Non-RAID** and press <Enter>.
2. Press the up/down arrow keys to select the drive(s) or disks of the RAID set you want to reset, then press <Space>. A small triangle before the Port number marks the selected drive. Press <Enter> when you are done.

```
[ RESET RAID DATA ]
Resetting RAID disk will remove its RAID structures
and revert it to a non-RAID disk.
WARNING: Resetting a disk causes all data on the disk to be lost.
(This does not apply to Recovery volumes)
Port  Drive Model  Serial #      Size      Status
---  -
0     ST3300656SS   HWAS000991753TR  279.3GB  Member Disk
1     ST3300656SS   37VN00009846RAJ1  279.3GB  Member Disk
Select the disks that should be reset.
[↑↓]-Previous/Next [SPACE]-Selects [ENTER]-Selection Complete
```

3. Press <Y> in the confirmation window to reset the drive(s) or press <N> to return to the utility main menu.

6.3.4 Exiting the Intel® Rapid Storage Technology enterprise SATA/SSATA Option ROM utility

To exit the utility:

1. From the utility main menu, select **4. Exit** then press <Enter>.
2. Press <Y> to exit or press <N> to return to the utility main menu.

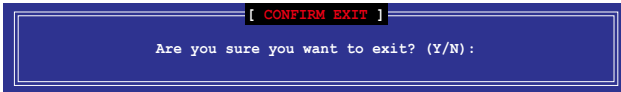

6.3.5 Rebuilding the RAID



This option is only for the RAID 1 set.

Rebuilding the RAID with other non-RAID disk

If any of the SATA hard disk drives included in the RAID 1 array failed, the system displays the status of the RAID volume as **"Degraded"** during POST. You can rebuild the RAID array with other installed non-RAID disks.

To rebuild the RAID with other non-RAID disk:

1. During POST, press <Ctrl>+<I> at the prompt to enter the Intel Rapid Storage Technology option ROM utility.
2. If there is a non-RAID SATA Hard Disk available, the utility will prompt you to rebuild the RAID. Press the up/down arrow keys to select the destination disk then Press <Enter> to start the rebuilding process, or press <ESC> to exit.

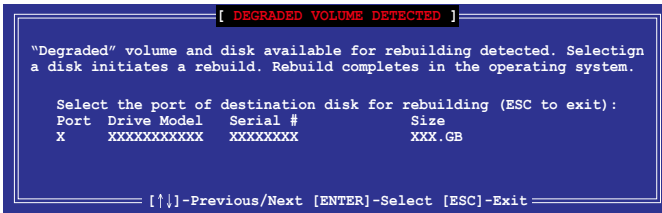

Select a destination disk with the same size as the original hard disk.

- The utility immediately starts rebuilding after the disk is selected. When done, the status of the degraded RAID volume is changed to **“Rebuild”**.

```

Intel(R) Rapid Storage Technology enterprise - SATA Option ROM - 3.6.0.1023
Copyright(C) 2003-12 Intel Corporation. All Rights Reserved.

[ MAIN MENU ]
1. Create RAID Volume
2. Delete RAID Volume
3. Reset Disks to Non-RAID
4. Exit

[ DISK/VOLUME INFORMATION ]

RAID Volumes:
ID Name Level Strip Size Status Bootable
1 Volume0 RAID1(Mirror) N/A 149.0GB Rebuild Yes

Physical Devices:
Port Drive Model Serial # Size Type/Status(Vol ID)
1 ST3160812AS 9LS0F4HL 149.0GB Member Disk(0)
2 ST3160812AS 3LS0JYL8 149.0GB Member Disk(0)

Volumes with "Rebuild" status will be rebuilt within the operating system.

[↑↓]-Select [ESC]-Exit [ENTER]-Select Menu

```

- Press <Esc> to exit Intel Rapid Storage Technology and reboot the system.
- Select **Start > Programs > Intel Rapid Storage > Intel Rapid Storage Console** or click the **Intel Rapid Storage Technology** tray icon to load the Intel Rapid Storage Manager utility.
- From the **View** menu, select **Advanced Mode** to display the details of the Intel Rapid Storage Console.
- From the **Volumes view** option, select **RAID volume** to view the rebuilding status. When finished, the status is changed to **“Normal”**.

Rebuilding the RAID with a new hard disk

If any of the SATA hard disk drives included in the RAID array failed, the system displays the status of the RAID volume as **“Degraded”** during POST. You may replace the disk drive and rebuild the RAID array.

To rebuild the RAID with a new hard disk:

- Remove the failed SATA hard disk and install a new SATA hard disk of the same specification into the same SATA Port.



Select a destination disk with the same size as the original hard disk.

- Reboot the system then follow the steps in section **Rebuilding the RAID with other non-RAID disk**.

6.3.6 Setting the Boot array in the BIOS Setup Utility

You can set the boot priority sequence in the BIOS for your RAID arrays when creating multi-RAID using the Intel® Rapid Storage Technology enterprise SATA Option ROM utility.

To set the boot array in the BIOS:



Set at least one of the arrays bootable to boot from the hard disk.

1. Reboot the system and press to enter the BIOS setup utility during POST.
2. Go to the **Boot** menu and select the boot option priority.
3. Use up/down arrow keys to select the boot priority and press <Enter>. See the **Boot menu** section of Chapter 4 for more details.
4. From the **Exit** menu, select **Save Changes & Exit**, then press <Enter>.
5. When the confirmation window appears, select **Yes**, then press <Enter>.

6.4 Intel® Rapid Storage Technology enterprise (Windows)

The Intel® Rapid Storage Technology enterprise allows you to create RAID 0, RAID 1, RAID 10 (RAID 1+0), and RAID 5 set(s) from Serial ATA hard disk drives that are connected to the Serial ATA connectors supported by the Southbridge.



You need to manually install the Intel® Rapid Storage Technology enterprise utility on a Windows® operating system. Please refer to the installation instructions in Chapter 6.

To enter the Intel® Rapid Storage Technology enterprise utility under Windows operating system:

1. Turn on the system and go to the windows desktop.
2. Click the **Intel® Rapid Storage Technology enterprise** icon to display the main menu.

Your storage system is configured for data protection, increased performance and optimal data storage capacity. You can create additional volumes to further optimize your storage system.

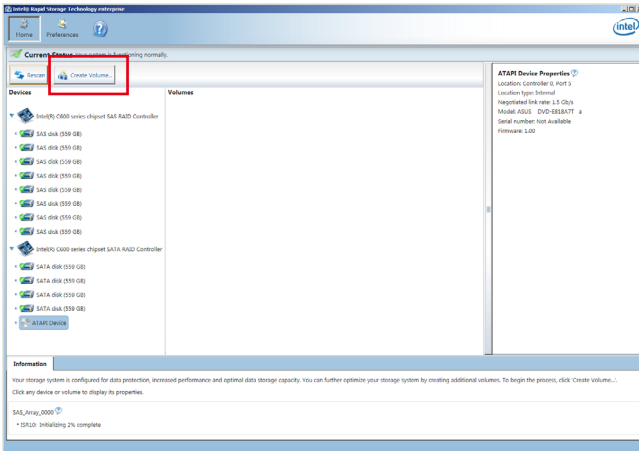

You can click **Rescan** to re-scan any attached hard disks.

6.4.1 Creating a RAID set

To create a RAID set:

1. From the utility main menu, select **Create Volume** and select volume type.
2. Click **Next**.

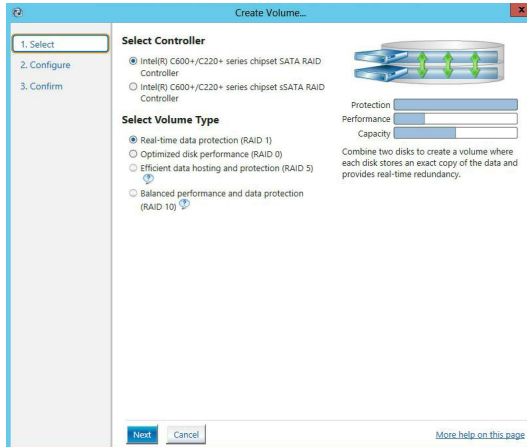

3. Enter a name for the RAID set, then select the array disks.
4. Select **Volume Size** tab, you can drag the bar to decide the volume size.
5. Click **Next**.

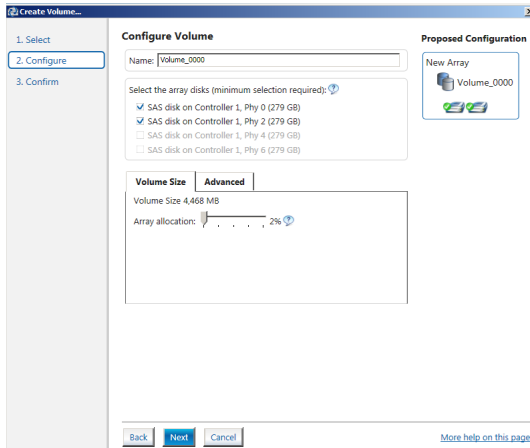

- If you do not want to keep the data on one of the selected disks, select **NO** when prompted.
- If you want to **Enable volume write-back cache** or **Initialize volume**, click **Advanced**.

6. Confirm the volume creation, then click **Create Volume** to continue.



This process could take a while depending on the number and size of the disks. You can continue using other applications during this time.

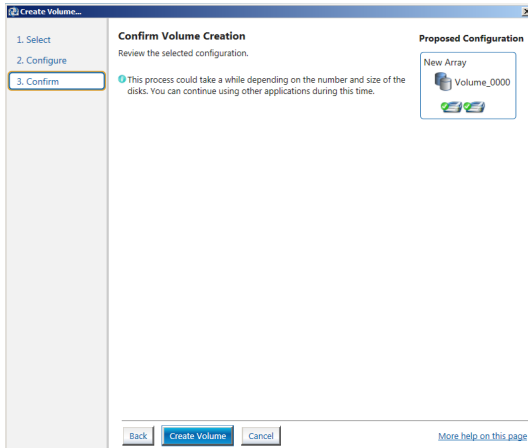

7. Wait until the process is completed, then click **OK** when prompted.

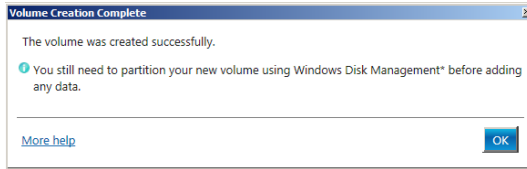

You still need to partition your new volume using Windows Disk Management before adding any data.

The RAID set is displayed in the **Volumes** list and you can change the settings in **Volume Properties**.

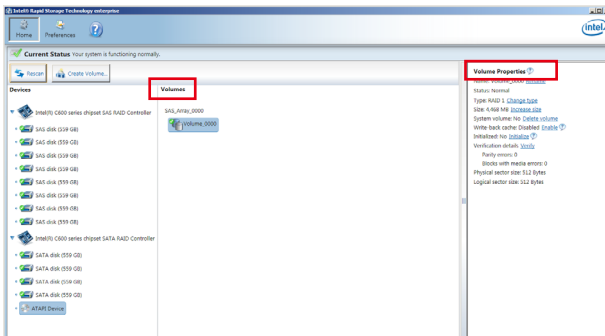

6.4.2 Changing a Volume Type

To change the volume type in **Volume Properties**:

1. Click the SATA array items you want to change in **Volumes** field.
2. From the **Volume Properties** field, select **Type:RAID 1 Change type**.

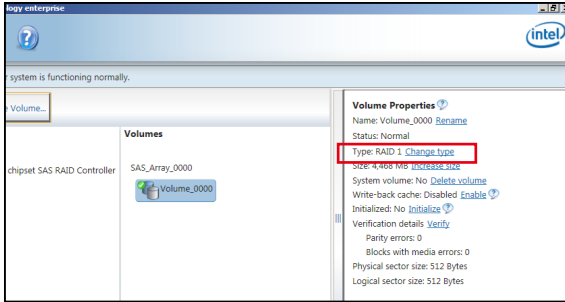

3. You can change the **Name**, **Select the new volume type**, and **Select additional disks to include in the new volume** if needed.
4. Select the **Data stripe size** for the RAID array (for RAID 0, 10 and 5 only), and click **OK**. The available stripe size values range from 4 KB to 128 KB. The following are typical values:
RAID 0: 128KB
RAID 10: 64KB
RAID 5: 64KB

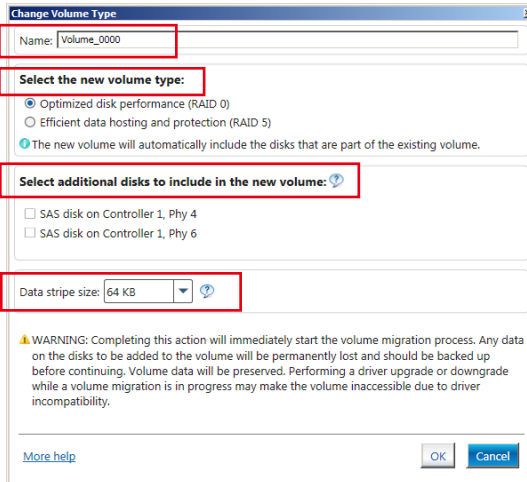

We recommend a lower stripe size for server systems, and a higher stripe size for multimedia computer systems used mainly for audio and video editing.

6.4.3 Deleting a volume



Be cautious when deleting a volume. You will lose all data on the hard disk drives. Before you proceed, ensure that you back up all your important data from your hard drives.

To delete a volume:

1. From the utility main menu, select the volume (exp. Volume_0000) in **Volumes** field you want to delete.

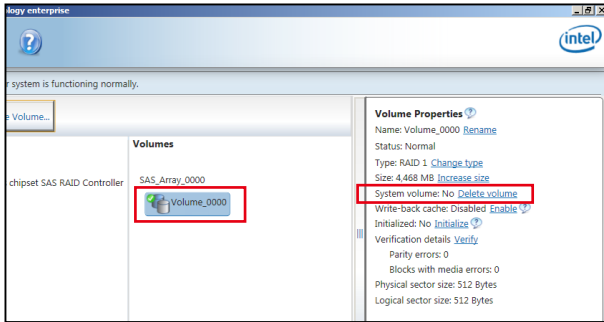

2. Select **Delete volume** in **Volume Properties** field. The following screen appears.

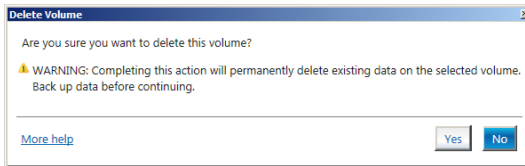

3. Click **Yes** to delete the volume and return to the utility main menu, or click **No** to return to the main menu.

6.4.4 Preferences

System Preferences

Allow you to set to show the notification area icon and show system information, warning, or errors here.

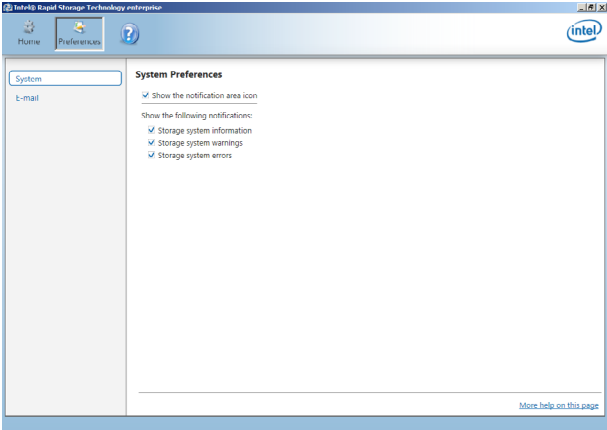

E-Mail Preferences

Allow you to set to sent e-mail of the following events:

- Storage system information
- Storage system warnings
- Storage system errors

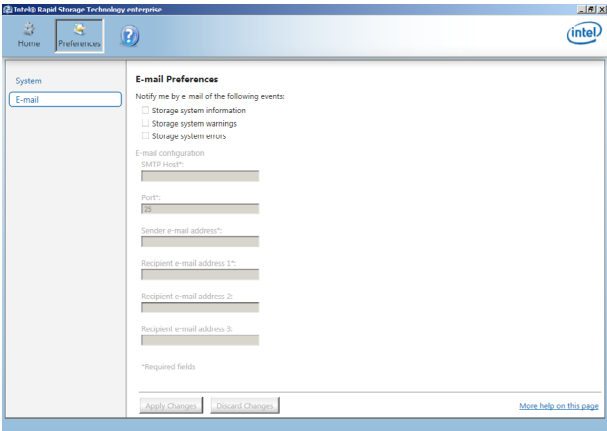

Driver installation

7

This chapter provides the instructions for installing the necessary drivers for different system components in both Linux[®] and Windows[®] Operating Systems.

7.1 RAID driver installation

After creating the RAID sets for your server system, you are now ready to install an operating system to the independent hard disk drive or bootable array. This part provides the instructions on how to install the RAID controller drivers during OS installation.

7.1.1 Creating a RAID driver disk



The system does not include a floppy drive. You have to use a USB floppy drive when creating a SATA RAID driver disk.



If you have created RAID sets with the LSI Software RAID configuration utility, the boot priority of the SATA optical disk drive has to be manually adjusted. Otherwise, the system will not boot from the connected SATA ODD.

To create a RAID driver disk in Windows® environment

1. Start Windows®.
2. Place the motherboard support DVD into the optical drive.
3. Go to the **Make disk** menu, and then select the type of RAID driver disk you want to create.
4. Insert a floppy disk into the USB floppy disk drive.
5. Follow succeeding screen instructions to complete the process.



Write-protect the floppy disk to avoid computer virus infection.

To create a RAID driver disk in Red Hat® Enterprise Linux server environment

1. Insert a blank formatted high-density floppy disk to the USB floppy disk drive.
2. Type `dd if=xxx.img of=/dev/fd0` to decompress the file into the floppy disk from the following path in the support DVD:

For LSI MegaRAID Driver

`\\Drivers\C610 LSI RAID\Driver\makediskLinux`

3. Eject the floppy disk.

7.1.2 Installing the RAID controller driver

During Windows® Server 2008 R2 OS installation

To install the RAID controller driver when installing Windows® Server 2008 R2 OS

1. Boot the computer using the Windows® Server 2008 R2 OS installation disc. Follow the screen instructions to start installing Windows Server 2008 R2.
2. When prompted to choose a type of installation, click **Custom (advanced)**.

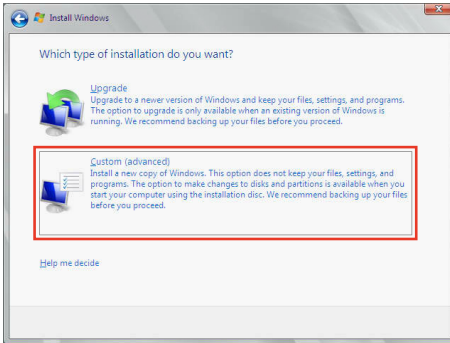

3. Click **Load Driver**.

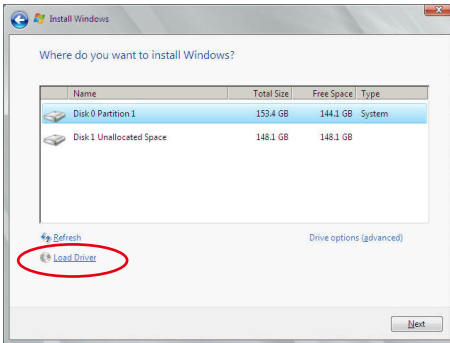

4. A message appears, reminding you to insert the installation media containing the driver of the RAID controller driver. If you have only one optical drive installed in your system, eject the Windows OS installation disc and replace with the motherboard Support DVD into the optical drive. Click **Browse** to continue.

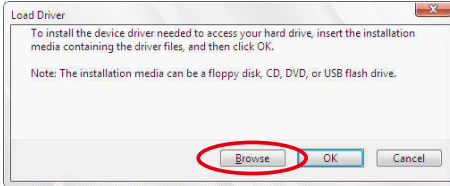

5. Locate the driver in the corresponding folder of the Support DVD then click **OK** to continue.
6. Select the RAID controller driver you need from the list and click **Next**.
7. When the system finishes loading the RAID driver, replace the motherboard Support DVD with the Windows Server installation disc. Select the drive to install Windows and click **Next**.

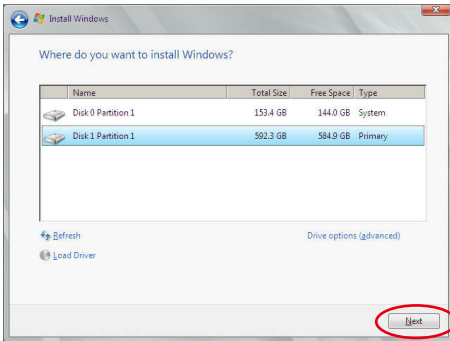

8. Setup then proceeds with the OS installation. Follow screen instructions to continue.

Red Hat® Enterprise Linux OS 5.x

To load the LSI MegaRAID controller driver when installing Red Hat® Enterprise OS:

1. Boot the system from the Red Hat® OS installation CD.
2. At the `boot:`, type `linux dd` then press <Enter>.

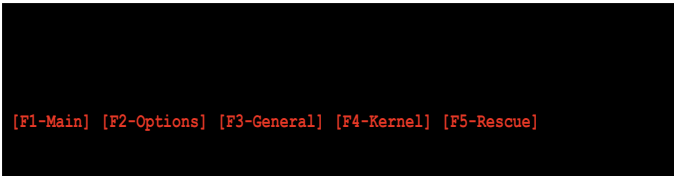

3. Select **Yes** using the <Tab> key when asked if you have the driver disk, then press <Enter>.

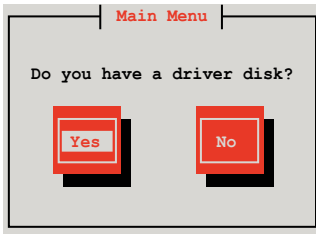

4. Insert the Red Hat® Enterprise RAID driver disk to the USB floppy disk drive, select **OK**, then press <Enter>.

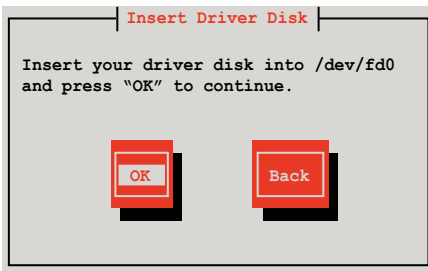

The drivers for the RAID card are installed to the system.

5. When asked if you will load additional RAID controller drivers, select **No**, then press <Enter>.

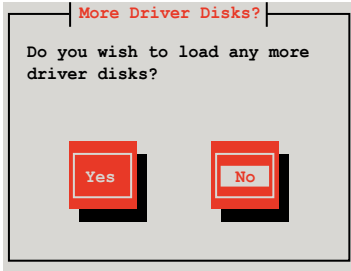

6. Follow the onscreen instructions to finish the OS installation.
7. When the installation is completed, DO NOT click **Reboot**. Press <Ctrl> + <Alt> + <F2> to switch to the command-line interface from graphic user interface.
8. Type the following commands when using a Legacy floppy.

```
mkdir /mnt/driver
mount /dev/fd0 /mnt/driver
cd /mnt/driver
sh replace_ahci.sh
reboot
```

Red Hat® Enterprise Linux OS 6.x

To install the LSI MegaRAID controller driver when installing Red Hat® Enterprise OS:

1. Boot the system from the Red Hat® OS installation CD.
2. Press <Tab> to edit options.

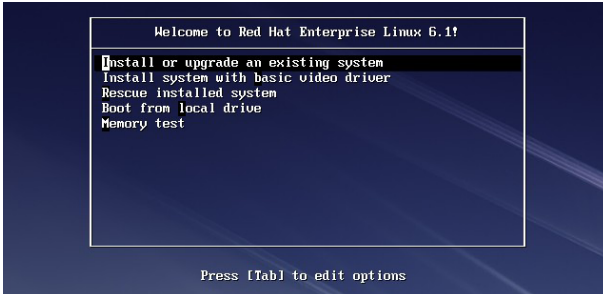

3. While booting from DVD, press <ESC> to give the third party driver. Enter the following command at the boot: `Linux dd blacklist=iscsi blacklist=ahci nodmraid`, then press <ENTER>.



4. Select Yes using the <Tab> key when asked if you have the driver disk, then press <Enter>.

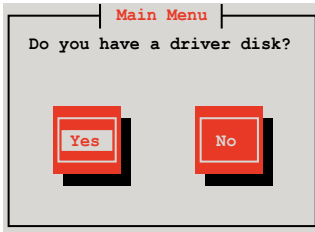

- 5 . You have multiple devices which could serve as source for a driver disk. Choose one you like to use and select **OK**, then press <Enter>.

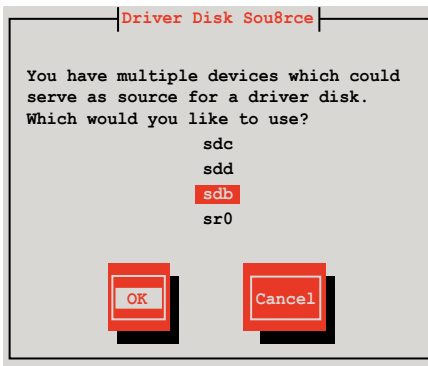

6. Insert the Red Hat® Enterprise RAID driver disk to the USB floppy disk drive, select **OK**, then press <Enter>.

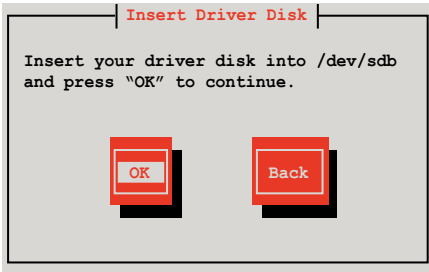

The drivers for the RAID card are installed to the system.

7. When asked if you will load additional RAID controller drivers, select **No**, then press <Enter>.

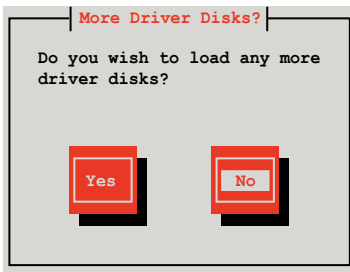

8. Follow the onscreen instructions to finish the OS installation.

Preparing the Linux Driver

Ensure that there is another computer with a Linux-based OS to create the RAID driver. When creating the RAID driver, you may refer to the examples below which uses a 64bit SUSE Linux system to create a 64bit RAID driver for SUSE11 sp1.

1. Copy the image file into the Linux system.

Example: `megasr-15.00.0120.2012-1-sles11-ga-x86_64.img`

2. Create a folder.

Example: `image`

3. Mount the image file into the image folder using this command format:

`mount -o loop [image file name] image`

Example: `mount -o loop megasr-15-15.00.0120.2012-1-sles11-ga-x86_64.img image`



4. Copy the contents of the image directory, labeled as **01**, into a FAT32 USB drive.



5. Rename the **01** folder to **CD Image**.



Installing SUSE 11 Linux OS

To install the LSI MegaRAID controller driver when installing SUSE Linux Enterprise Server OS:

1. Boot the system from the SUSE OS installation CD.
2. Use the arrow keys to select **Installation** from the **Boot Options** menu.

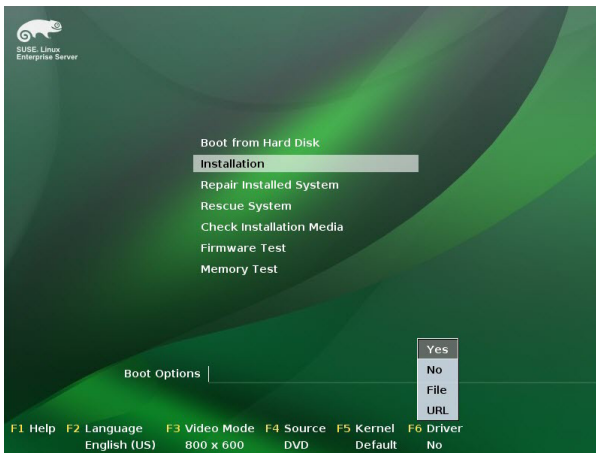

3. Press <F6>, then select **Yes** from the menu. Press <Enter>.



4. Use the USB drive to provide the third-party driver during the OS installation. Type the command **brokenmodules=ahci** in **Boot Options** field, and press <Enter>.

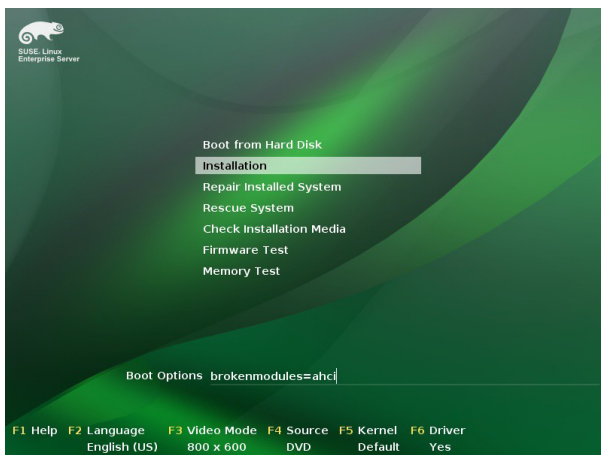

5. When below screen appears, select the USB floppy disk drive (sda) as the driver update medium. Select **OK**, then press <Enter>.

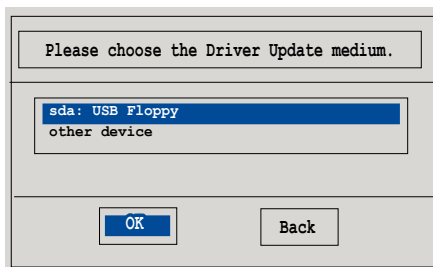

6. Select **Back** and follow the onscreen instructions to finish the installation.

7.2 Management applications and utilities installation

The support DVD that is bundled with your motherboard contains drivers, management applications, and utilities that you can install to maximize the features of your motherboard.



1. The contents of the support DVD are subject to change at any time without notice. Visit the ASUS website (www.asus.com) for the latest updates on software and utilities.
2. The support DVD is supported on Windows® Server 2008 R2 and Windows® Server 2012.

7.3 Running the Support DVD

When you place the support DVD into the optical drive, the DVD automatically displays the main screen if Autorun is enabled in your computer. By default, the Drivers tab is displayed.



If Autorun is NOT enabled in your computer, browse the contents of the support DVD to locate the file **ASSETUP.EXE** from the **BIN** folder. Double-click the **ASSETUP.EXE** to run the support DVD.

The main screen of the Support DVD contains the following tabs:

1. Drivers
2. Utilities
3. MakeDisk
4. Manual
5. Contact



The main screen of the Support DVD looks exactly the same on the Windows® Server 2008 R2 and on the Windows® Server 2012 Operating System (OS).

7.3.1 Drivers menu tab

The Drivers Menu shows the available device drivers if the system detects installed devices. Install the necessary drivers to activate the devices.



7.3.2 Utilities menu tab

The Utilities menu displays the software applications and utilities that the motherboard supports.



7.3.3 MakeDisk menu tab

The MakeDisk menu contains items to create the Intel RAID driver disks.



Press the arrow down button in the lower part of the menu to view more items.

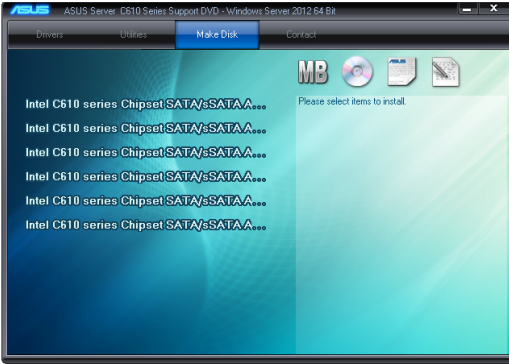

7.3.4 Manual menu

The Manual menu provides the link to the Broadcom NetXtreme II Network Adapter user guide.



You need an internet browser installed in your OS to view the User Guide.

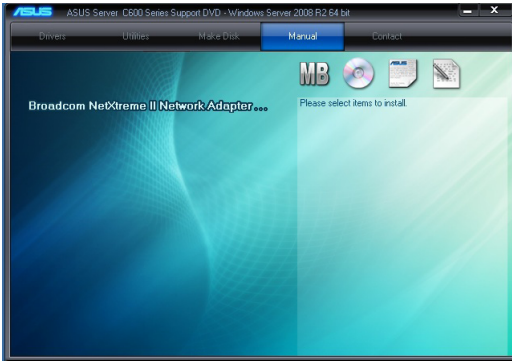

7.3.5 Contact information menu

The Contact menu displays the ASUS contact information, e-mail addresses, and useful links if you need more information or technical support for your motherboard.



7.4 Intel® chipset device software installation

This section provides the instructions on how to install the Intel® chipset device software on the system.

You need to manually install the Intel® chipset device software on a Windows operating system.

To install the Intel® chipset device software:

1. Restart the computer, and then log on with **Administrator** privileges.
2. Insert the motherboard/system support DVD to the optical drive. The support DVD automatically displays the **Drivers** menu if Autorun is enabled in your computer.



If Autorun is NOT enabled in your computer, browse the contents of the support DVD to locate the file **ASSETUP.EXE** from the **BIN** folder. Double-click the **ASSETUP.EXE** to run the support DVD.

3. Click the item **Intel Chipset Device Software** from the menu.

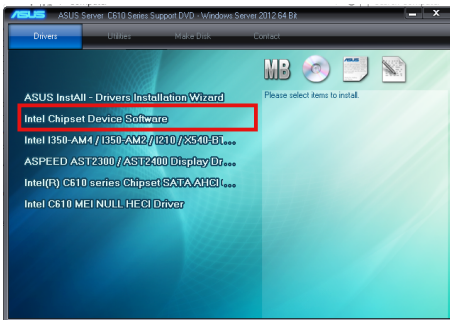

4. The **Intel(R) Chipset Device Software** window appears. Click **Next** to start installation.



5. Select **Yes** to accept the terms of the **License Agreement** and continue the process.

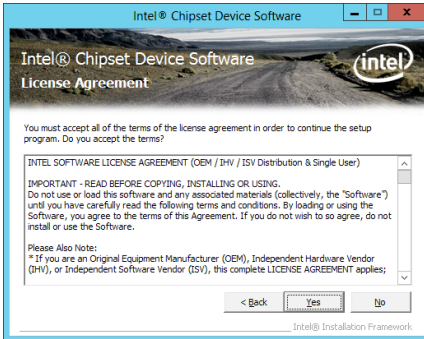

6. Read the **Readme File Information** and press **Next** to continue the installation.

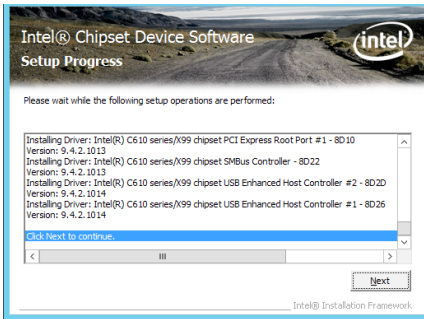

7. Toggle **Yes, I want to restart the computer now** and click **Finish** to complete the setup process.



7.5 Installing the Intel® I350-AM1/I350-AM2/I210 X540-BT2 Gigabit Adapters driver

This section provides the instructions on how to install the **Intel® I350-AM1/I350-AM2/I210/X540-BT2 Gigabits Adapter Driver** on the system.

To install the **Intel® I350-AM1/I350-AM2/I210/X540-BT2 Gigabit Adapters Driver** on the Windows® operating system:

1. Restart the computer.
2. Log on with **Administrator** privileges.
3. Insert the motherboard/system support DVD to the optical drive.



If Autorun is NOT enabled in your computer, browse the contents of the support DVD to locate the file **ASSETUP.EXE** from the **BIN** folder. Double-click the **ASSETUP.EXE** to run the support DVD.

4. Click **Intel® I350-AM1/I350-AM2/I210/X540-BT2 Gigabit Adapters Drivers** in the **Drivers** menu of the main screen to start the installation.

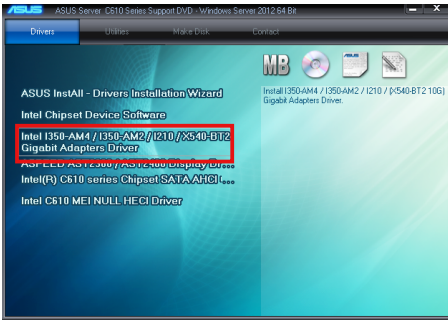

5. Click **Install Drivers and Software** option to begin installation.

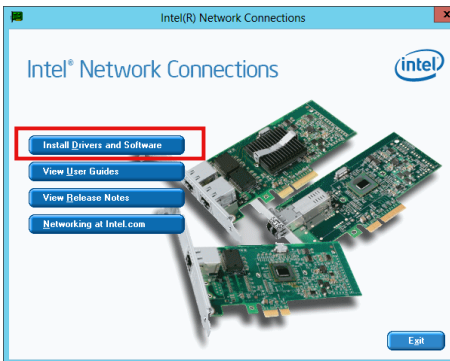

6. Click **Next** when the **Intel(R) Network Connections–InstallShield Wizard** window appears.

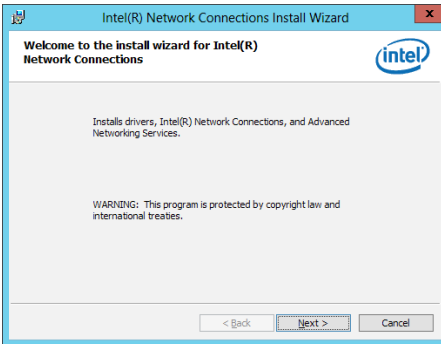

7. Tick **I accept the terms in the license agreement** and click **Next** to continue.

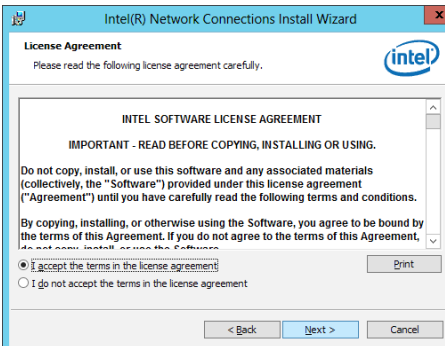

8. From the **Setup Options** window, click **Next** to start the installation.



By default, **Intel(R) PROSet for Windows Device Manager** and **Windows PowerShell Module** are ticked.

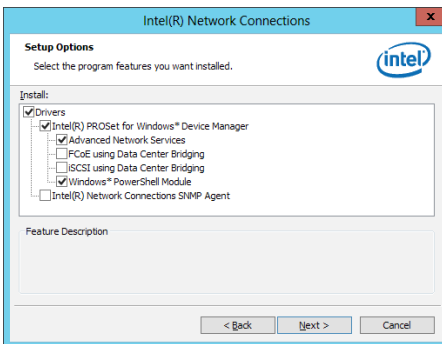

9. Click **Install** to start the installation.

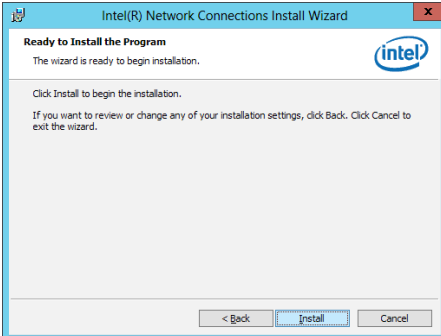

10. When the installation is done, press **Finish** to complete the installation.

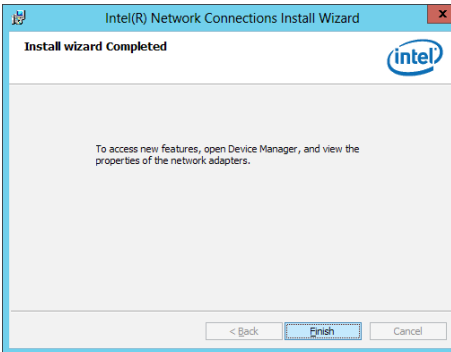

7.6 VGA driver installation

This section provides the instructions on how to install the ASPEED Video Graphics Adapter (VGA) driver.

You need to manually install the ASPEED VGA driver on a Windows® operating system.

To install the ASPEED VGA driver:

1. Restart the computer, and then log on with **Administrator** privileges.
2. Insert the motherboard/system support DVD to the optical drive. The support DVD automatically displays the **Drivers** menu if Autorun is enabled in your computer.



If Autorun is **NOT** enabled in your computer, browse the contents of the support DVD to locate the file **ASSETUP.EXE** from the **BIN** folder. Double-click the **ASSETUP.EXE** to run the support DVD.

3. Click the **ASPEED AST2300 / AST2400 Display Driver** to begin installation.

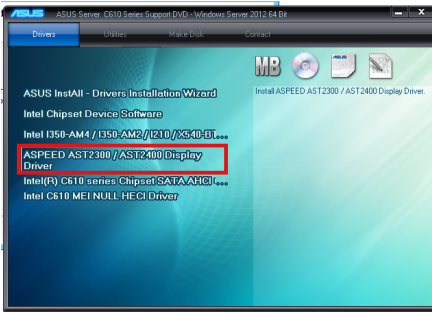

4. From the installation window, click **Next** to start the installation.



5. Click **Install** to proceed with the installation.

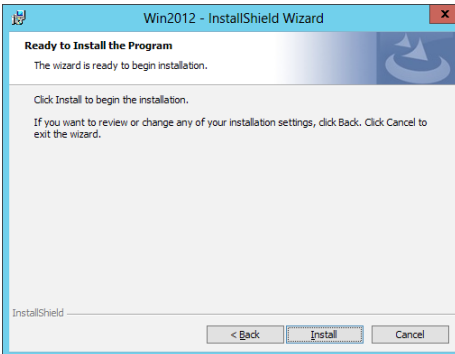

6. Click **Finish** to complete the installation.

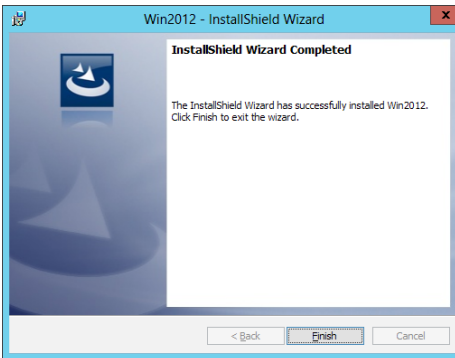

7.7 Intel® Rapid Storage Technology enterprise 4.0 installation

This section provides the instructions on how to install the Intel® Rapid Storage Technology enterprise 4.0 on the system.

You need to manually install the Intel® Rapid Storage Technology enterprise 4.0 utility on a Windows® operating system.

To install the Intel® Rapid Storage Technology enterprise 4.0 utility:

1. Restart the computer, and then log on with **Administrator** privileges.
2. Insert the motherboard/system support DVD to the optical drive, and find the utility menu.
3. Click the **Intel® Rapid Storage Technology enterprise 4.0** to begin installation.

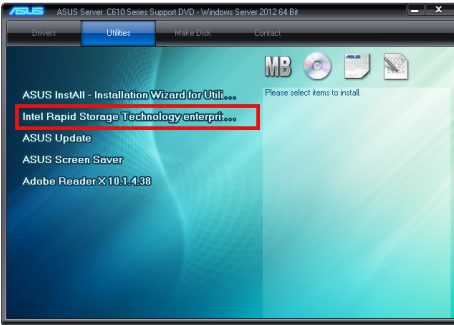

4. When the **Welcome to the Setup Program** appears, click **Next** to start the installation.

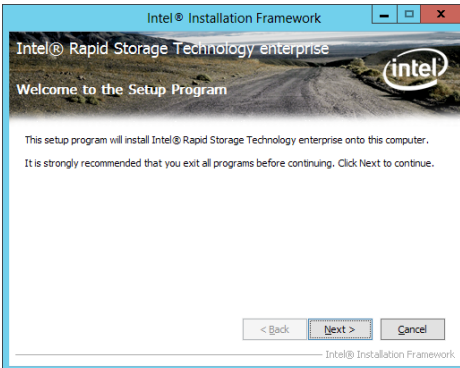

5. Read the **Warning** message and click **Next** to continue.

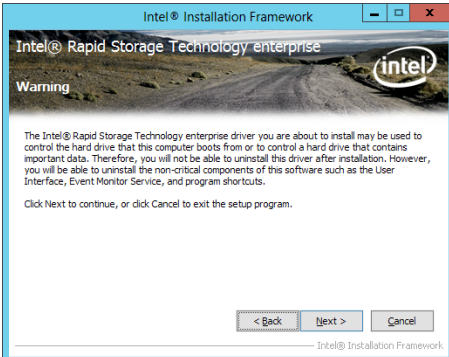

6. Read the **License Agreement** and click **Yes** to continue.

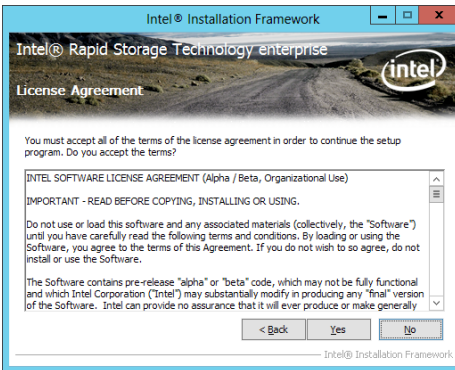

7. Read the **Readme File Information** and click **Next** to continue.

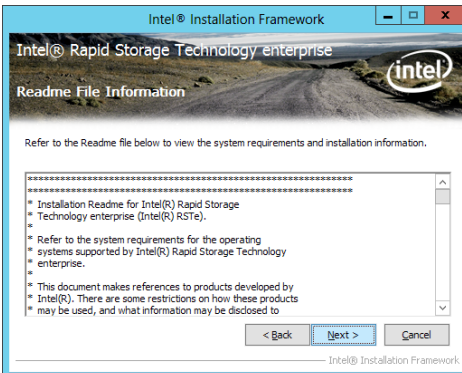

8. After completing the installation, click **Next** to complete the setup process.

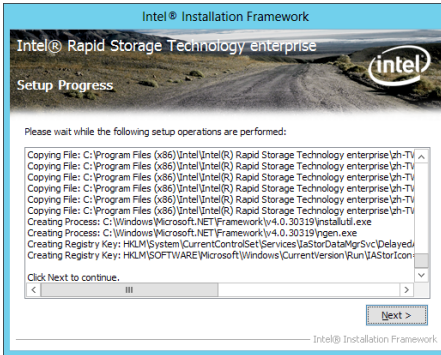

9. Select **Yes, I want to restart my computer now** and click **Finish** to restart your computer before using the program.

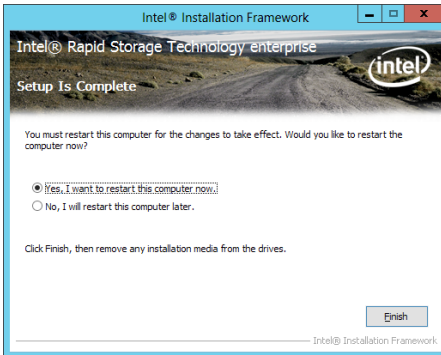

Appendix

This appendix includes additional information that you may refer to when configuring the motherboard.

Z10PP-D24 block diagram

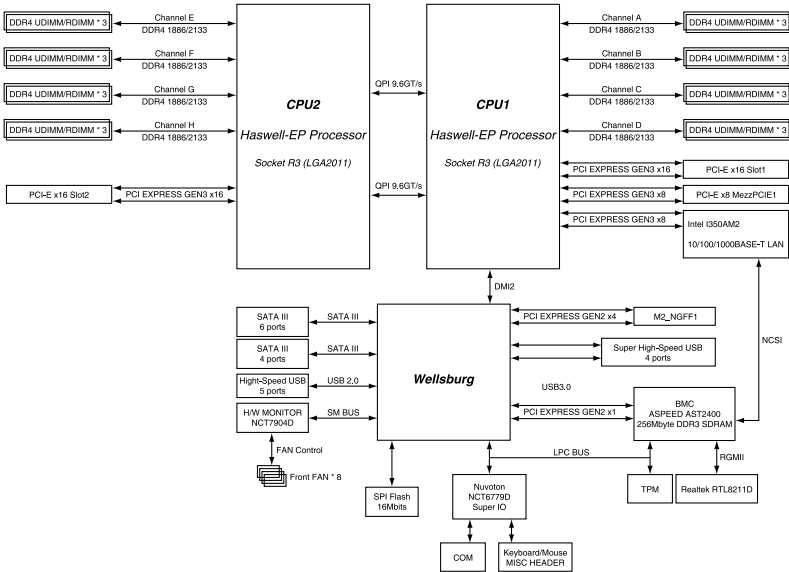

Notices

Federal Communications Commission Statement

This device complies with Part 15 of the FCC Rules. Operation is subject to the following two conditions:

- This device may not cause harmful interference.
- This device must accept any interference received including interference that may cause undesired operation.

This equipment has been tested and found to comply with the limits for a Class A digital device, pursuant to Part 15 of the FCC Rules. These limits are designed to provide reasonable protection against harmful interference in a residential installation. This equipment generates, uses and can radiate radio frequency energy and, if not installed and used in accordance with manufacturer's instructions, may cause harmful interference to radio communications. However, there is no guarantee that interference will not occur in a particular installation. If this equipment does cause harmful interference to radio or television reception, which can be determined by turning the equipment off and on, the user is encouraged to try to correct the interference by one or more of the following measures:

- Reorient or relocate the receiving antenna.
- Increase the separation between the equipment and receiver.
- Connect the equipment to an outlet on a circuit different from that to which the receiver is connected.
- Consult the dealer or an experienced radio/TV technician for help.



The use of shielded cables for connection of the monitor to the graphics card is required to assure compliance with FCC regulations. Changes or modifications to this unit not expressly approved by the party responsible for compliance could void the user's authority to operate this equipment.

Canadian Department of Communications Statement

This digital apparatus does not exceed the Class B limits for radio noise emissions from digital apparatus set out in the Radio Interference Regulations of the Canadian Department of Communications.

This class A digital apparatus complies with Canadian ICES-003.

REACH

Complying with the REACH (Registration, Evaluation, Authorisation, and Restriction of Chemicals) regulatory framework, we published the chemical substances in our products at ASUS REACH website at <http://csr.asus.com/english/REACH.htm>.



DO NOT throw the motherboard in municipal waste. This product has been designed to enable proper reuse of parts and recycling. This symbol of the crossed out wheeled bin indicates that the product (electrical and electronic equipment) should not be placed in municipal waste. Check local regulations for disposal of electronic products.



DO NOT throw the mercury-containing button cell battery in municipal waste. This symbol of the crossed out wheeled bin indicates that the battery should not be placed in municipal waste.

ASUS Recycling/Takeback Services

ASUS recycling and takeback programs come from our commitment to the highest standards for protecting our environment. We believe in providing solutions for you to be able to responsibly recycle our products, batteries, other components as well as the packaging materials. Please go to <http://csr.asus.com/english/Takeback.htm> for detailed recycling information in different regions.

Australia statement notice

From 1 January 2012 updated warranties apply to all ASUS products, consistent with the Australian Consumer Law. For the latest product warranty details please visit <http://support.asus.com>. Our goods come with guarantees that cannot be excluded under the Australian Consumer Law. You are entitled to a replacement or refund for a major failure and compensation for any other reasonably foreseeable loss or damage. You are also entitled to have the goods repaired or replaced if the goods fail to be of acceptable quality and the failure does not amount to a major failure.

If you require assistance please call ASUS Customer Service 1300 2787 88 or visit us at <http://support.asus.com>.

ASUS contact information

ASUSTeK COMPUTER INC.

Address 15 Li-Te Road, Peitou, Taipei, Taiwan 11259
Telephone +886-2-2894-3447
Fax +886-2-2890-7798
E-mail info@asus.com.tw
Web site <http://www.asus.com>

ASUSTeK COMPUTER INC. (Taiwan)

Address 15 Li-Te Road, Peitou, Taipei, Taiwan 11259
Telephone +886-2-2894-3447
Fax +886-2-2890-7798
E-mail info@asus.com.tw
Web site <http://tw.asus.com>

Technical Support

Telephone +886-2-2894-3447 (0800-093-456)
Online Support <http://support.asus.com/techserv/techserv.aspx>

ASUSTeK COMPUTER INC. (China)

Address No.508, Chundong Road, Minhang District,
Shanghai, 201108 China
Telephone +86-21-5442-1616
Fax +86-21-5442-0099
Web site <http://cn.asus.com>

Technical Support

Telephone +86-20-2804-7506 (800-820-6655)
Online Support <http://support.asus.com/techserv/techserv.aspx>

ASUS contact information

ASUS COMPUTER INTERNATIONAL (America)

Address 800 Corporate Way, Fremont, CA 94539, USA
Fax +1-510-608-4555
Web site <http://usa.asus.com>

Technical Support

Support fax +1-812-284-0883
General support +1-812-282-2787
Online support <http://support.asus.com/techserv/techserv.aspx>

ASUS COMPUTER GmbH (Germany and Austria)

Address Harkort Str. 21-23, 40880 Ratingen, Germany
Fax +49-2102-959911
Web site <http://www.asus.de>
Online contact <http://www.asus.de/sales>

Technical Support

Telephone +49-1805-010923
Support Fax +49-2102-959911
Online support <http://support.asus.com/techserv/techserv.aspx>

ASUS Czech Service s.r.o. (Europe)

Address Na Rovince 887, 720 00 Ostrava – Hrabová, Czech Republic
Telephone +420-596766888
Web site <http://www.asus.cz>

Technical Support

Telephone +420-596-766-891
Fax +420-596-766-329
E-mail advance.rma.eu@asus.com
Online Support <http://support.asus.com/techserv/techserv.aspx>

ASUS contact information

ASUS Holland BV (The Netherlands)

Address Marconistraat 2, 7825GD EMMEN, The Netherlands
Web site <http://www.asus.com>

Technical Support

Telephone +31-(0)591-5-70292
Fax +31-(0)591-666853
E-mail advance.rma.eu@asus.com
Online Support <http://support.asus.com/techserv/techserv.aspx>

ASUS Polska Sp. z o.o. (Poland)

Address Ul. Postępu 6, 02-676 Warszawa, Poland
Web site <http://pl.asus.com>

Technical Support

Telephone +48-225718033
Online Support <http://support.asus.com/techserv/techserv.aspx>

ASK-Service (Russia and CIS)

Address г.Москва, ул. Орджоникидзе, д.10, Россия
Telephone (495) 640-32-75
Web site <http://ru.asus.com>

Technical Support

Telephone 008-800-100-ASUS (008-800-100-2787)
Online Support <http://vip.asus.com/eservice/techserv.aspx?SLanguage=ru>

