

AIC

J2012-01

SAS/SATA JBOD SERIES

User's Manual

D/N:MAN-00306-A

P/N:

CONTENTS

PREFACE	i
SAFETY INSTRUCTIONS	ii
Chapter 1. Product Introduction	1
1.1 Box Content	1
1.2 Specifications	2
1.3 General Information.....	3
1.4 SCSI Enclosure Services - 2 (SES-2).....	6
Chapter 2. Hardware Installation	7
2.1 Removing and Installing Top Cover	7
2.2 Removing/Installing a Drive Tray/ Hard Drive/ Drive Slot Map.....	8
2.3 Removing and Installing a PSU Module	10
2.4 Removing and Installing a Fan Module	11
2.5 Removing and Installing External Expander Module.....	12
2.6 Removing and Installing the HDD backplane Module.....	13
2.7 Installing Slide Rail /Adjuster Plate	14
Chapter 3. Sub-System Configuration Setup	17
3.1 Supported Configuration On Host.....	17
3.2 Utility Set up on Host.....	18
3.3 Connect Host to JBOD via RS232	21
3.4 Configure command Line Interface Operation	22
3.5 Power on/off the enclosure via RS232.....	49
Chapter 4. BMC Configuration and Settings	51
4.1 Sensor's location for Fan & Temperature	51
4.2 Utility setup on Host	52
4.3 Connect Host to BMC by RS232	52
4.4 Web UI	56
4.4.1 Dashboard	56
4.5 Firmware Update	75
4.6 Expander firmware update	80
4.7 Firmware safety mode	83
Chapter 5. Technical Support	88



Copyright © 2015 AIC, Inc. All Rights Reserved.

This document contains proprietary information about AIC products and is not to be disclosed or used except in accordance with applicable agreements.

PREFACE

- **Copyright**

No part of this publication may be reproduced, stored in a retrieval system, or transmitted in any form or by any means, electronic, mechanical, photo-static, recording or otherwise, without the prior written consent of the manufacturer.

- **Trademarks**

All products and trade names used in this document are trademarks or registered trademarks of their respective holders.

- **Changes**

The material in this document is for information purposes only and is subject to change without notice.

- **Warning**

1. A shielded-type power cord is required in order to meet FCC emission limits and also to prevent interference to the nearby radio and television reception. It is essential that only the supplied power cord be used.
2. Use only shielded cables to connect I/O devices to this equipment.
3. You are cautioned that changes or modifications not expressly approved by the party responsible for compliance could void your authority to operate the equipment.

- **Disclaimer**

AIC shall not be liable for technical or editorial errors or omissions contained herein. The information provided is provided "as is" without warranty of any kind. To the extent permitted by law, neither AIC or its affiliates, subcontractors or suppliers will be liable for incidental, special or consequential damages including downtime cost; lost profits; damages relating to the procurement of substitute products or services; or damages for loss of data, or software restoration. The information in this document is subject to change without notice.

SAFETY INSTRUCTIONS

- Before getting started, please read the following important cautions:
- All cautions and warnings on the equipment or in the manuals should be noted.
- Most electronic components are sensitive to electrical static discharge. Therefore, be sure to ground yourself at all times when installing the internal components.
- Use a grounding wrist strap and place all electronic components in static-shielded devices. Grounding wrist straps can be purchased in any electronic supply store.
- Be sure to turn off the power and then disconnect the power cords from your system before performing any installation or servicing. A sudden surge of power could damage sensitive electronic components.
- Do not open the system's top cover. If opening the cover for maintenance is a must, only a trained technician should do so. Integrated circuits on computer boards are sensitive to static electricity. Before handling a board or integrated circuit, touch an unpainted portion of the system unit chassis for a few seconds. This will help to discharge any static electricity on your body.
- Place this equipment on a stable surface when install. A drop or fall could cause injury.
- Please keep this equipment away from humidity.
- Carefully mount the equipment into the rack, in such manner, that it won't be hazardous due to uneven mechanical loading.
- This equipment is to be installed for operation in an environment with maximum ambient temperature below 35°C.
- The openings on the enclosure are for air convection to protect the equipment from overheating. **DO NOT COVER THE OPENINGS.**
- Never pour any liquid into ventilation openings. This could cause fire or electrical shock.
- Make sure the voltage of the power source is within the specification on the label when connecting the equipment to the power outlet. The current load and output power of loads shall be within the specification.
- This equipment must be connected to reliable grounding before using. Pay special attention to power supplied other than direct connections, e.g. using of power strips.
- Place the power cord out of the way of foot traffic. Do not place anything over the power cord. The power cord must be rated for the

- product, voltage and current marked on the product's electrical ratings label. The voltage and current rating of the cord should be greater than the voltage and current rating marked on the product.
- If the equipment is not used for a long time, disconnect the equipment from mains to avoid being damaged by transient over-voltage.
- Never open the equipment. For safety reasons, only qualified service personnel should open the equipment.
- If one of the following situations arise, the equipment should be checked by service personnel:
 1. The power cord or plug is damaged.
 2. Liquid has penetrated the equipment.
 3. The equipment has been exposed to moisture.
 4. The equipment does not work well or will not work according to its user manual.
 5. The equipment has been dropped and/or damaged.
 6. The equipment has obvious signs of breakage.
 7. Please disconnect this equipment from the AC outlet before cleaning. Do not use liquid or detergent for cleaning. The use of a moisture sheet or cloth is recommended for cleaning.
- Module and drive bays must not be empty! They must have a dummy cover.

Product features and specifications are subject to change without notice.

CAUTION :

RISK OF EXPLOSION IF BATTERY IS REPLACED BY AN INCORRECT TYPE.

DISPOSE OF USED BATTERIES ACCORDING TO THE INSTRUCTIONS.

AFTER PERFORMING ANY INSTALLATION OR SERVICING, MAKE SURE THE ENCLOSURE ARE LOCK AND SCREW IN POSITION, TURN ON THE POWER.

Chapter 1. Product Introduction

1.1 Box Content

Before removing the subsystem from the shipping carton, visually inspect the physical condition of the shipping carton. Exterior damage to the shipping carton may indicate that the contents of the carton are damaged. If any damage is found, do not remove the components; contact the dealer where the subsystem was purchased for further instructions. Before continuing, first unpack the subsystem and verify that the contents of the shipping carton are all there and in good condition.

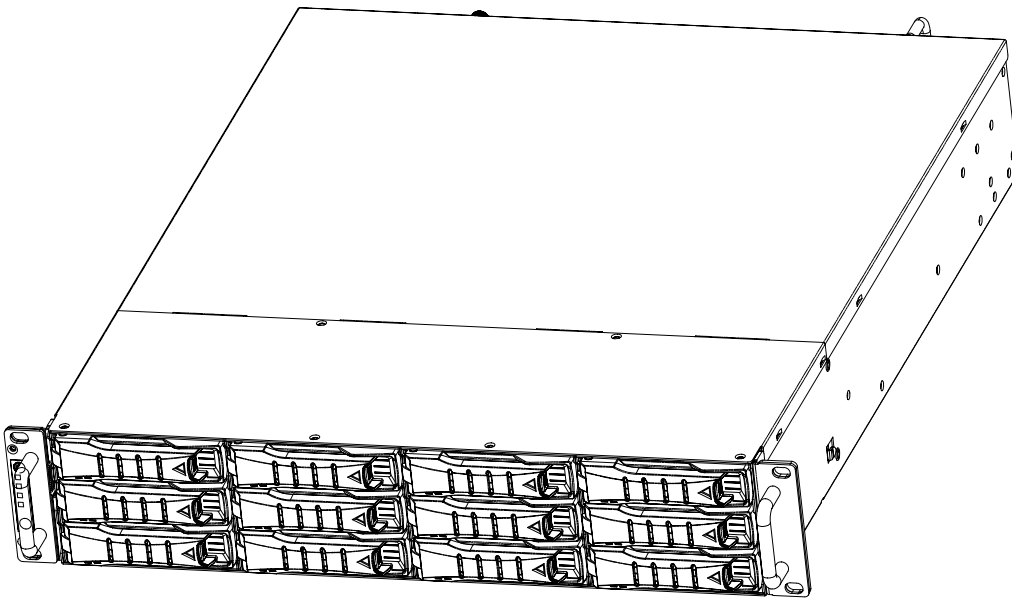

- Enclosure(Power supply, fan, 12 HDD tray included)

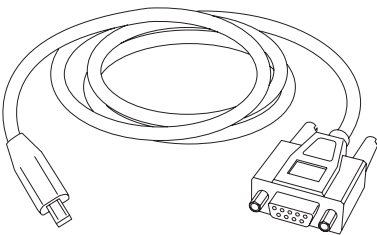

- RS232 cable x 1pc

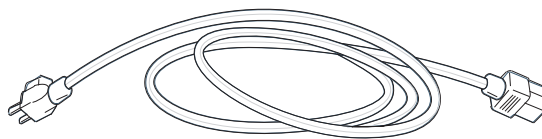

- Power cord x 2pcs

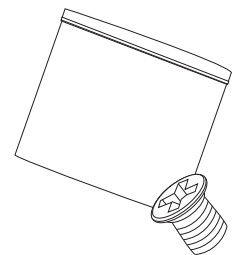

- Screws kit x 1set

- Mounting Optional



- Slide Rail x 1set

or

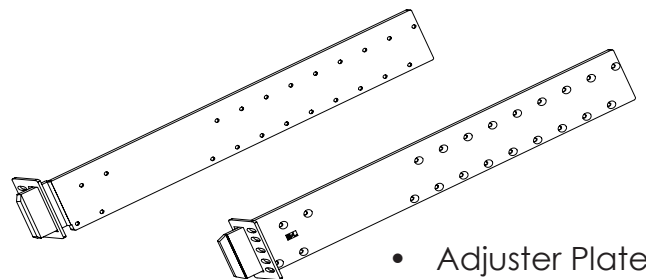

- Adjuster Plate x 1set

If any items are missing, please contact your authorized reseller or sales representative.
J2012-01 User's Manual

1.2 Specifications

General	Number of Expander	Single/Dual	Electrical and Environmental	Universal A/C Input	100~240V AC full range
	Expander Chip	LSI SAS3x28R		Operating Environment	Temperature 0°C to 35°C Relative humidity 20% to 80%
	Host/Expansion Interface	3 x Mini SAS HD (SFF-8644) per expander tray		Non-operating Environment	Temperature -20°C to 60°C Relative humidity 10% to 90%
Drives Supported	Drive Interface	12Gb & 6Gb SAS if using dual expanders 12Gb & 6Gb SAS/SATA if using single expander	Physical Specification	Dimensions (W x D x H) (with chassis ears)	mm : 483 x 534 x 88.2 inches : 19 x 21 x 3.5
	Form Factor	3.5"		Gross Weight (w/ PSU, w/o Rail & Disks)	kgs : 22.1 lbs : 46.3
Administration / Management	Admin/Firmware Upgrade	In-band & Serial port interface IEM port (Optional)		Packaging Dimensions (W x D x H)	mm : 595 x 785 x 278 inches : 23.4 x 30.9 x 10.9
	LED indicators, Audible Alarm	Yes		Mounting	Standard
Hot swap and Redundancy	Disk Drive	Hot swap 12-bay	Option		20" tool-less rail
	Cooling	2 x 6038 hot swap fans			
	Power Supply	549W 1+1 hot swap redundant 80+ Platinum			
	Power Entry	Dual AC Inlet			
	Expander	Dual expanders			

1.3 General Information

J2012-01 is a 2U rackmount chassis with 12 x 3.5" HDD hot swap bay and dual expand module JBOD, which is a high performance, high density, scalable storage product. The J2012-01 JBOD supports T10 zoning function and can be shared by up to 3 servers.

- Front Panel

Supports hot-swappable 12 x 3.5" HDDs

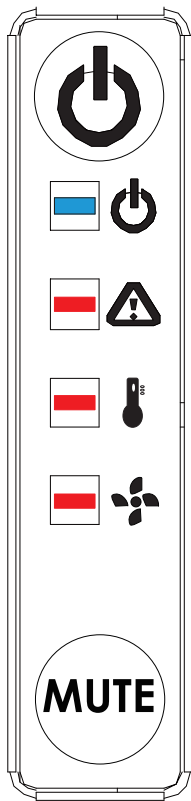
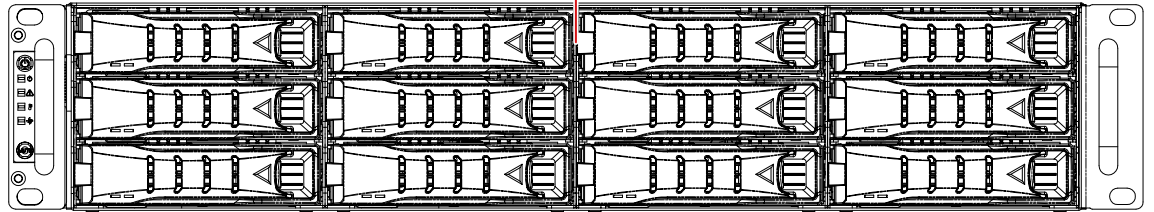

LED Indicator and Switch



System PWR Switch	
Behavior	Status
Normal	Off
Press	Boot up
Long Press	system shut down



Power Fault LED	
Behavior	LED Status
Normal	Off
Failed	Red



Temperature(Overheat) LED	
Behavior	LED Status
Normal	Off
Failed	Red



Fan fault LED	
Behavior	LED Status
Normal	Off
Failed	Red





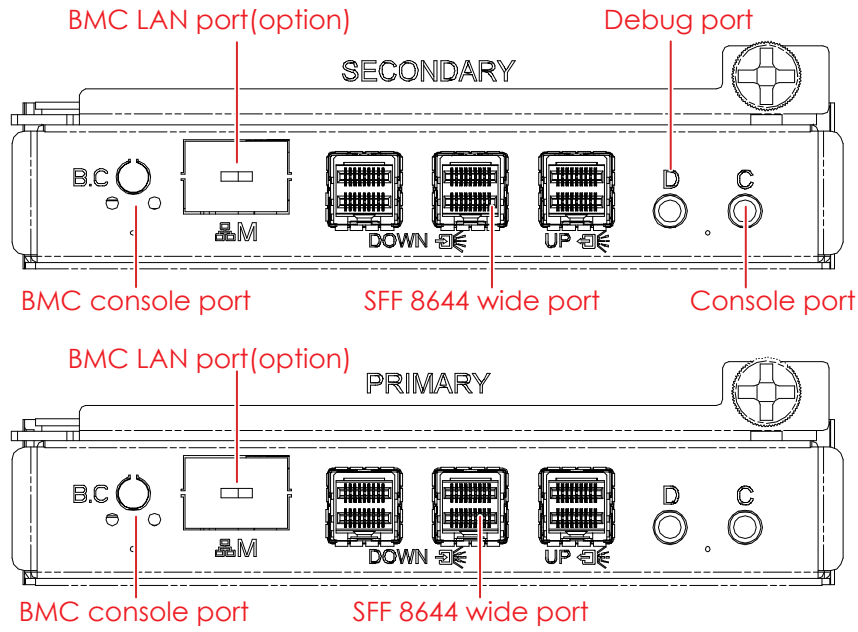

System Alert Mute Switch	
Behavior	Status
Normal	Off
Press	Alert mute

Chapter 1 Product Introduction

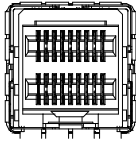
- Rear Expander Panel

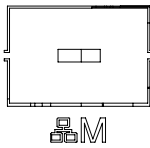

Item	Description
	SFF8644 wide port
	Console port
	Debug port
	BMC LAN port
	BMC console port

2 Dual Expander (Primary & Secondary)

Chapter 1 Product Introduction

- Rear Panel

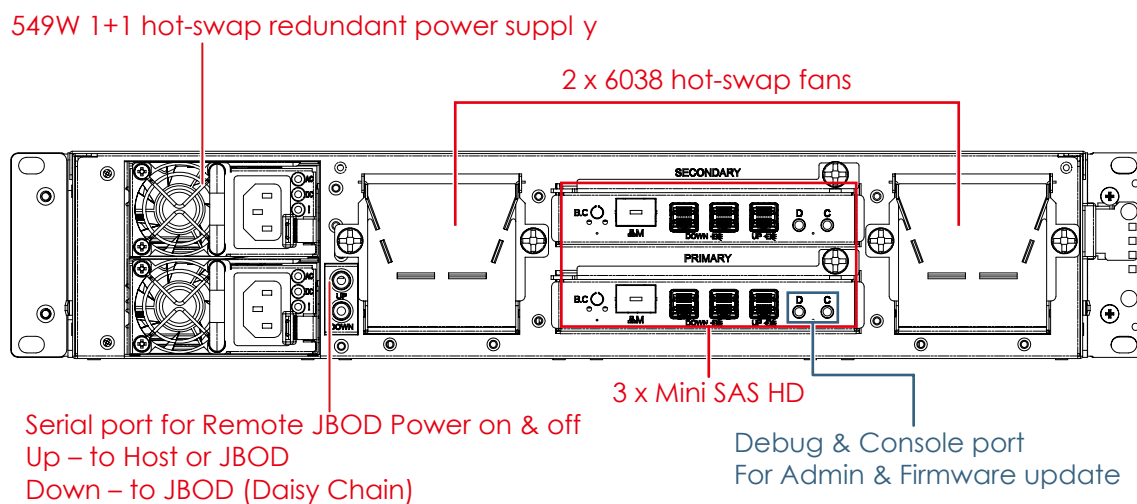

1.4 SCSI Enclosure Services - 2 (SES-2)

To ensure J2012-01 can work properly and provide high performance, durability. J2012-01 has implemented SCSI Enclosure Services-2 to monitor the status of power supply, system cooling fan and working temperature. It also has the indicators to deliver the status of fail devices such as power supply or cooling fan. You can get the information directly from the front indicators to know how your enclosure works.

For detailed information, please visit <http://www.t10.org>

If you are a member of the T10 working group, the Standard which controlled by T10 technical committee, could be found at <http://www.t10.org/cgi-bin/ac.pl?t=f&f=ses2r19a.pdf>

1.4.1 SES pages supported are listed below

- 00h -list of supported diagnostic pages
- 01h -SES -configuration
- 02h -SES -enclosure control / enclosure status
- 07h -SES -element descriptor
- 0Ah -SES -additional element
- 0Eh -SES -download microcode control / SES download microcode status

1.4.2 SES elements supported are listed below.

- 02h -power-supply
- 03h -cooling
- 04h -temperature-sensor
- 0Eh -enclosure
- 12h -Voltage
- 17h -array device

Chapter 2. Hardware Installation

This chapter provides detailed instructions on hardware installation.

2.1 Removing and Installing Top Cover

Loosen 2 screws on top cover. Take it out of the enclosure.

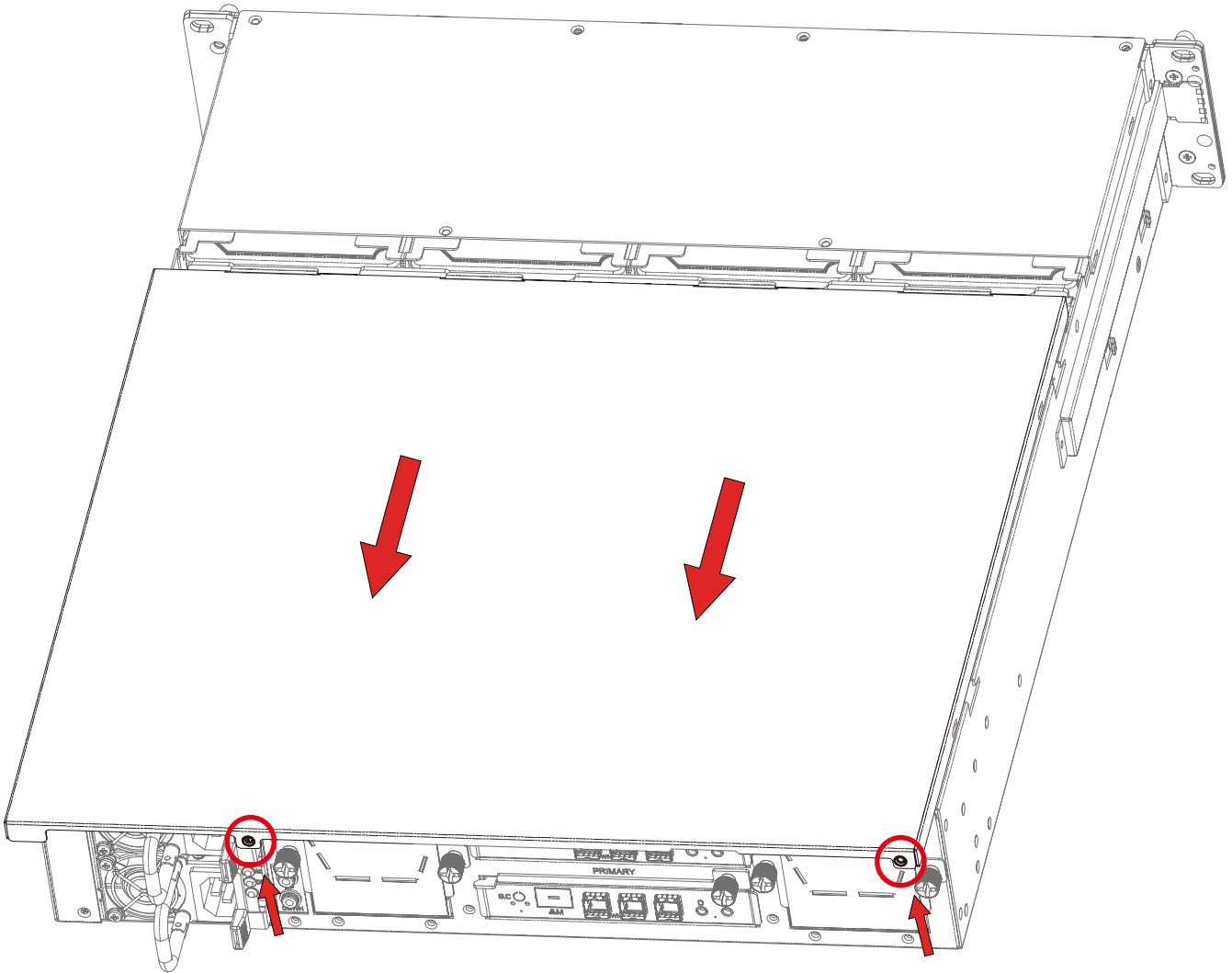

2.2 Removing/Installing a Drive Tray/ Hard Drive/ Drive Slot Map

2.2.1 Removing a Disk Drive

Release a drive tray by pressing the unlock button and pinching the lock lever slightly and pulling out the drive tray.

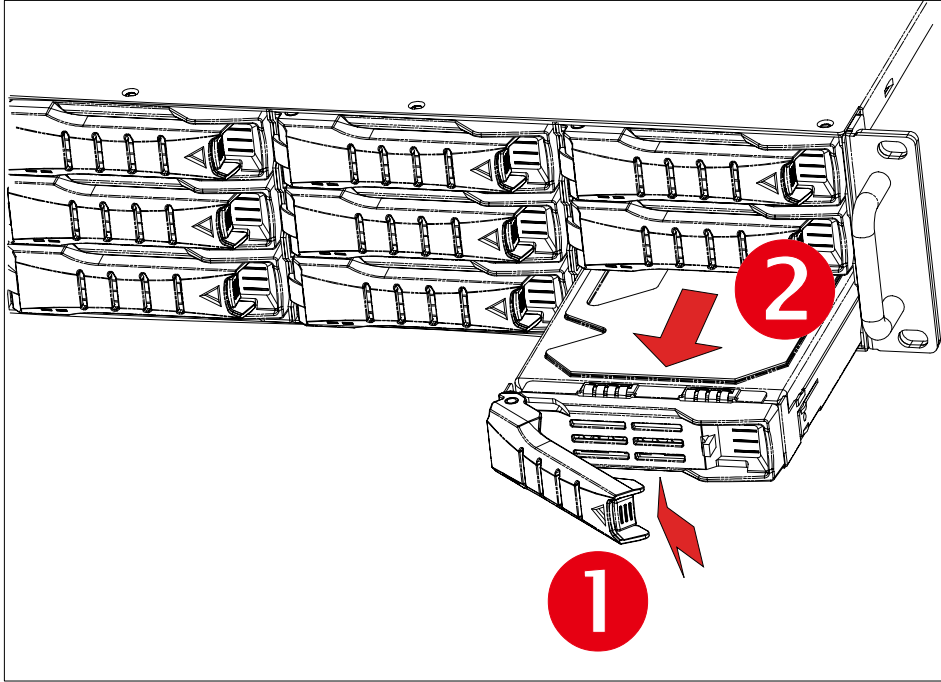

2.2.2 Installing a 3.5" Disk Drive

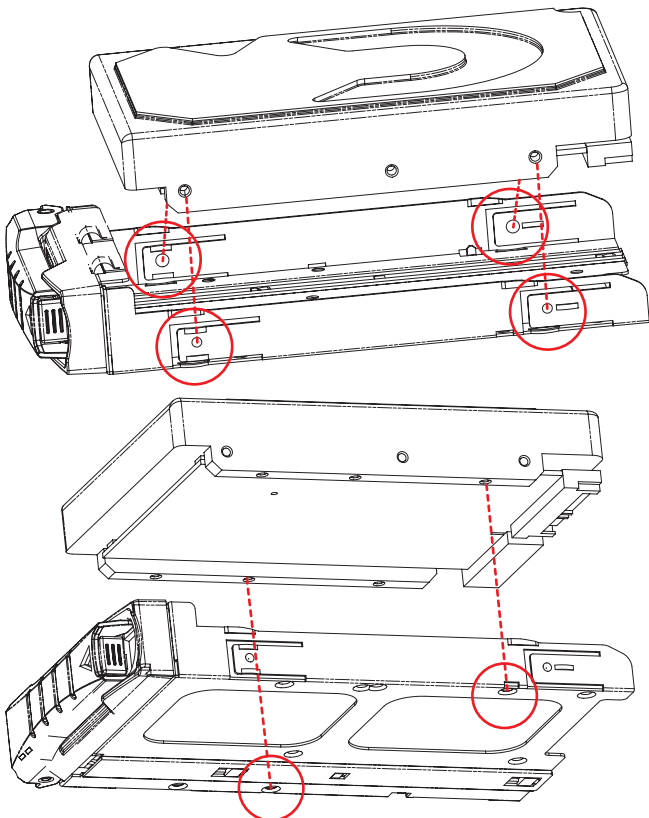

Directly place HDD into tool-less HDD tray until it snaps. Please check if the screw holes on HDD match the dimples on HDD tray.

HDD can also be screwed on HDD tray by fastening two screws as picture showed.

Chapter 2 Hardware Installation

2.2.3 Installing a Hard Disk Drive Tray

Insert the drive carrier into its bay. Push the tray lever until it clicks. Make sure the drive tray is correctly secured in place when its front edge aligns with the bay edge.

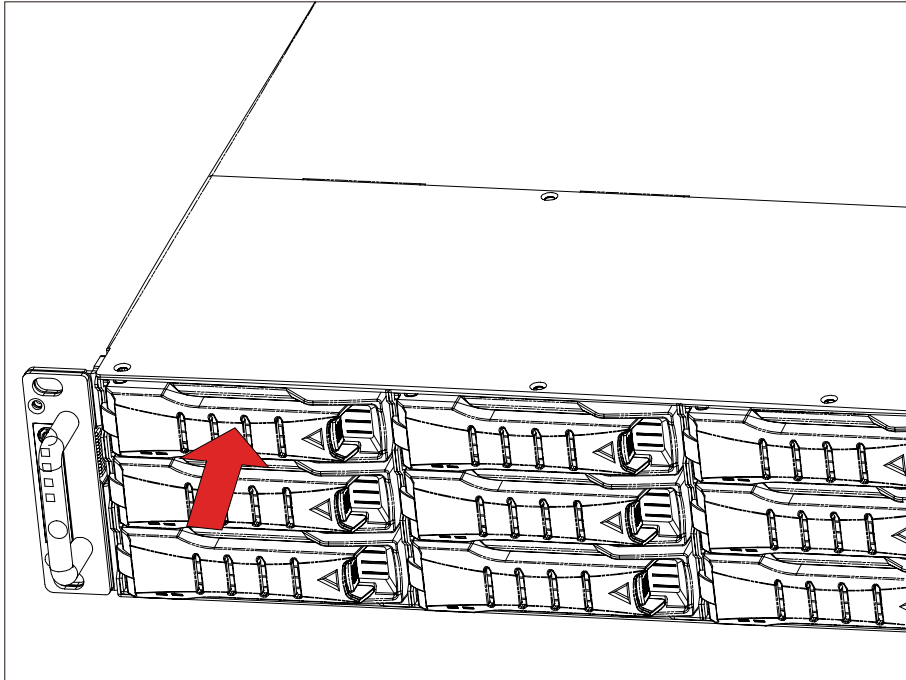

2.2.4 Drive Slot Map

The drive slot map follows.

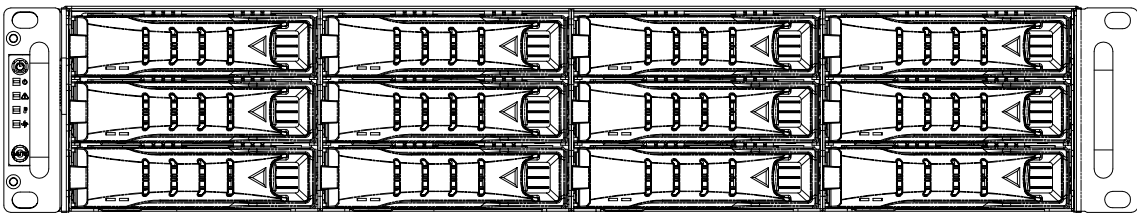

HBA card				MegaRaid card			
0	1	2	3	1	2	3	4
4	5	6	7	5	6	7	8
8	9	10	11	9	10	11	12

2.3 Removing and Installing a PSU Module

2.3.1 Removing a PSU module

- Remove power cables connected to the PSU module.
- Allow a minute for fan to spin down.
- Pushing the latch then hold the tray handle tab. Then pull the PSU module gently until it slides out of the JBOD.

2.3.2 Installing a PSU Module

- Slide in PSU module.
- Make sure the latch on the module is fully hooked onto the PSU housing.

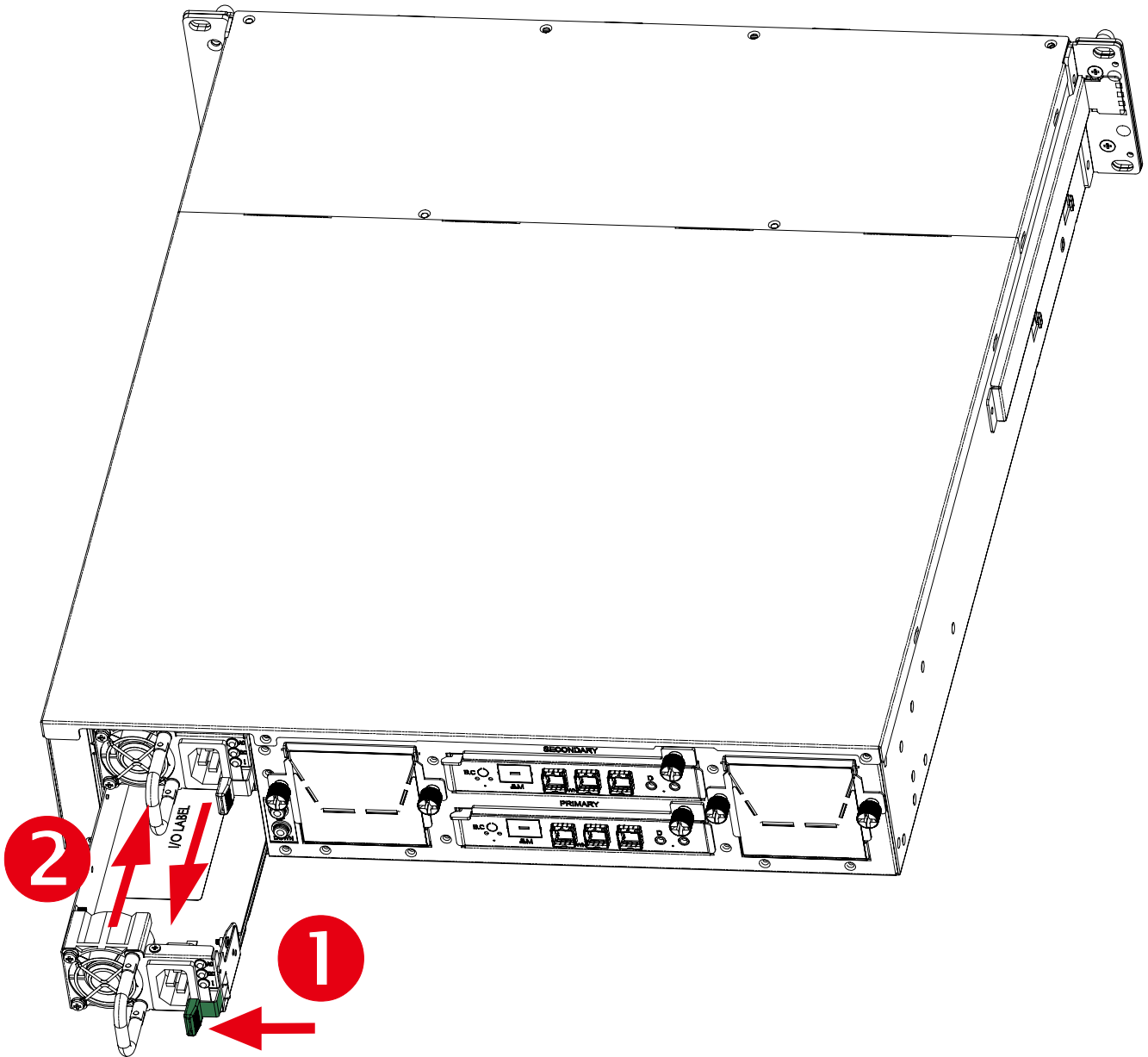

2.4 Removing and Installing a Fan Module

2.4.1 Removing a Fan module

- Loosen the thumb screws on each sides in front of fan module.
- Hold the fan module from both sides.
- Pull the fan module gently and firmly until it clears the enclosure chassis.

2.4.2 Installing a Fan Module

- Align the fan module with the opening in the enclosure.
- Insert the fan module into JBOD.

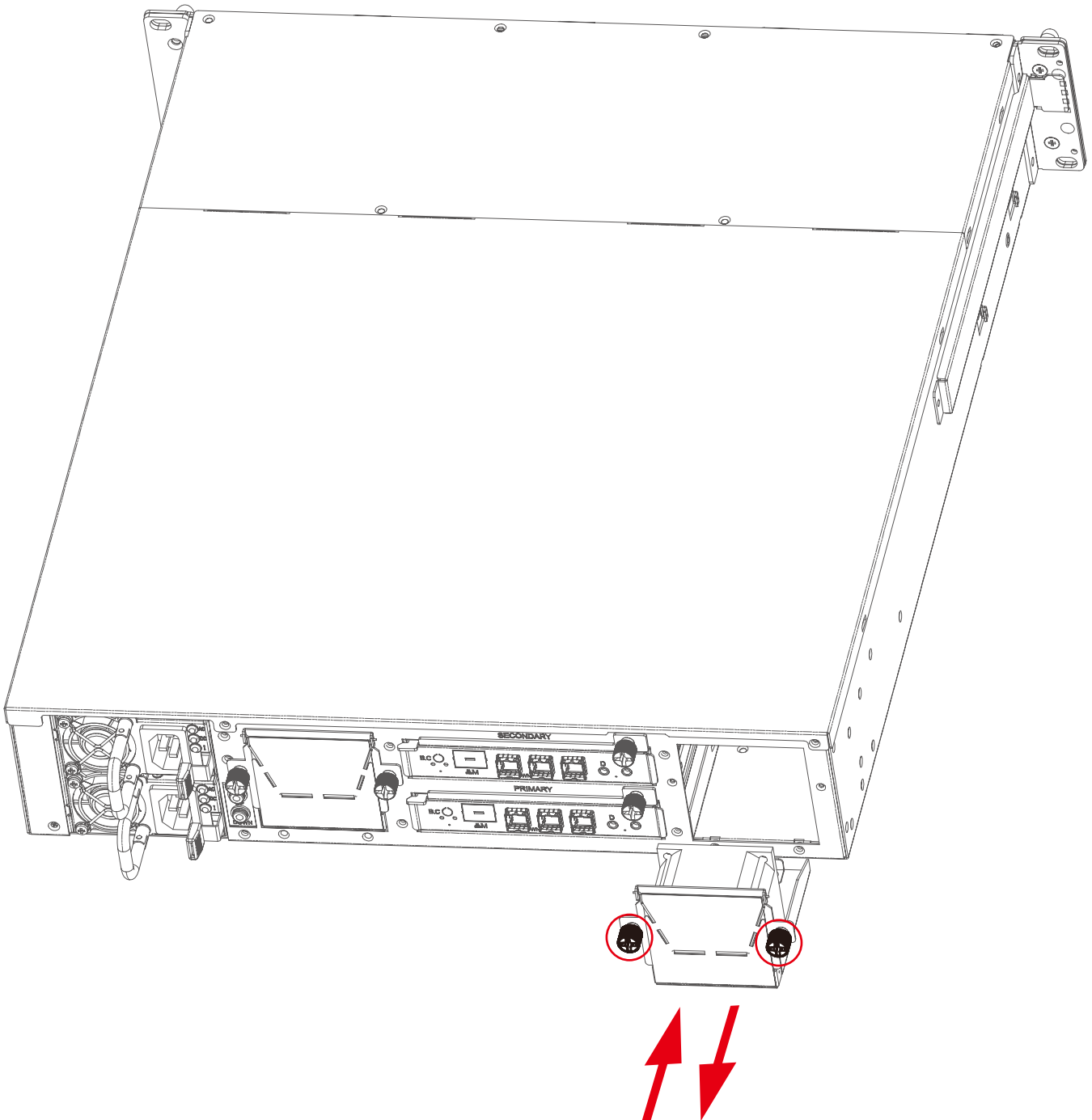

2.5 Removing and Installing External Expander Module

2.5.1 Removing an expander module

- Loosen the thumb screw to release expander tray lever.
- Hold the lever to pull the expander out of JBOD.

2.5.2 Installing an expander module

- Align the expander module with the opening in front of the enclosure, and insert it into the enclosure firmly.
- Close the lever and secure the retaining screw.

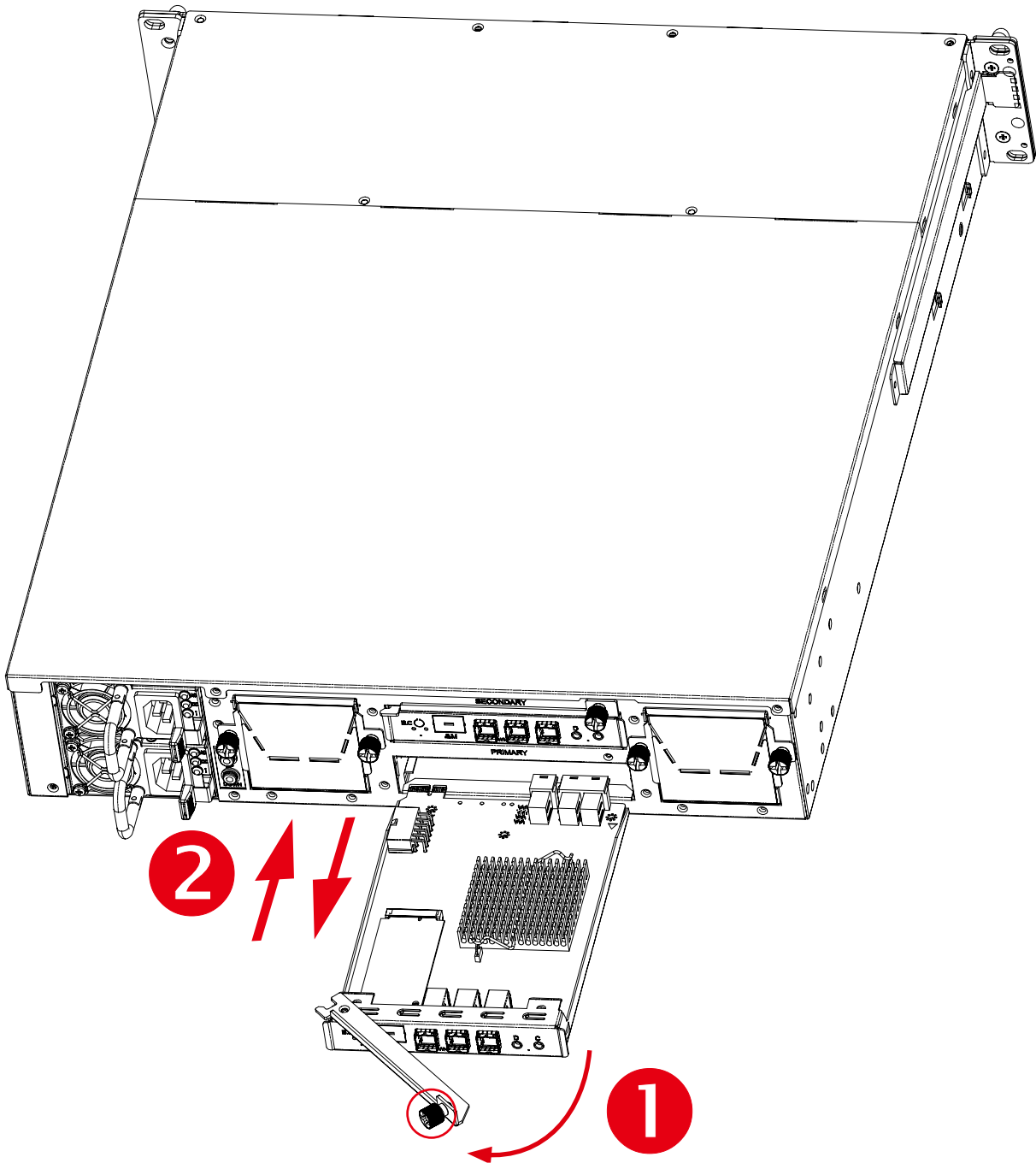

2.6 Removing and Installing the HDD backplane Module

2.6.1 Removing a HDD backplane module

- Unscrew 8pcs screws in the middle side of JBOD to release the HDD backplane module. (2* top side 2* bottom side *2 both side)
- Hold the backplane module to pull the backplane module out of JBOD.

2.6.2 Installing a HDD backplane module

- Slide the HDD backplane module into JBOD.
- Secure the HDD backplane module onto the JBOD using the screws.

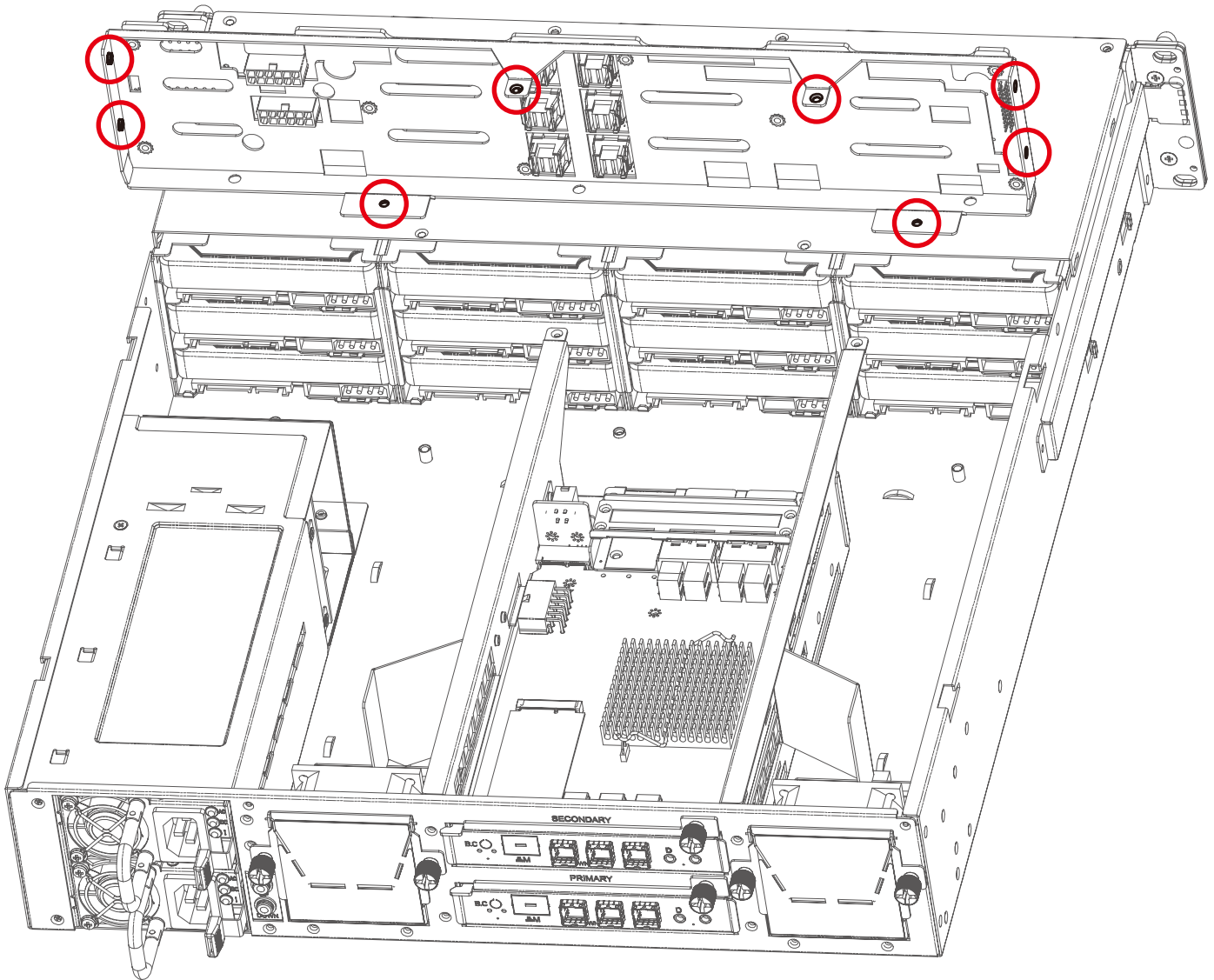

2.7 Installing Slide Rail /Adjuster Plate

2.7.1 Installing slide rail

To install the slide rail, please refer to the manual in the slide rail kit.

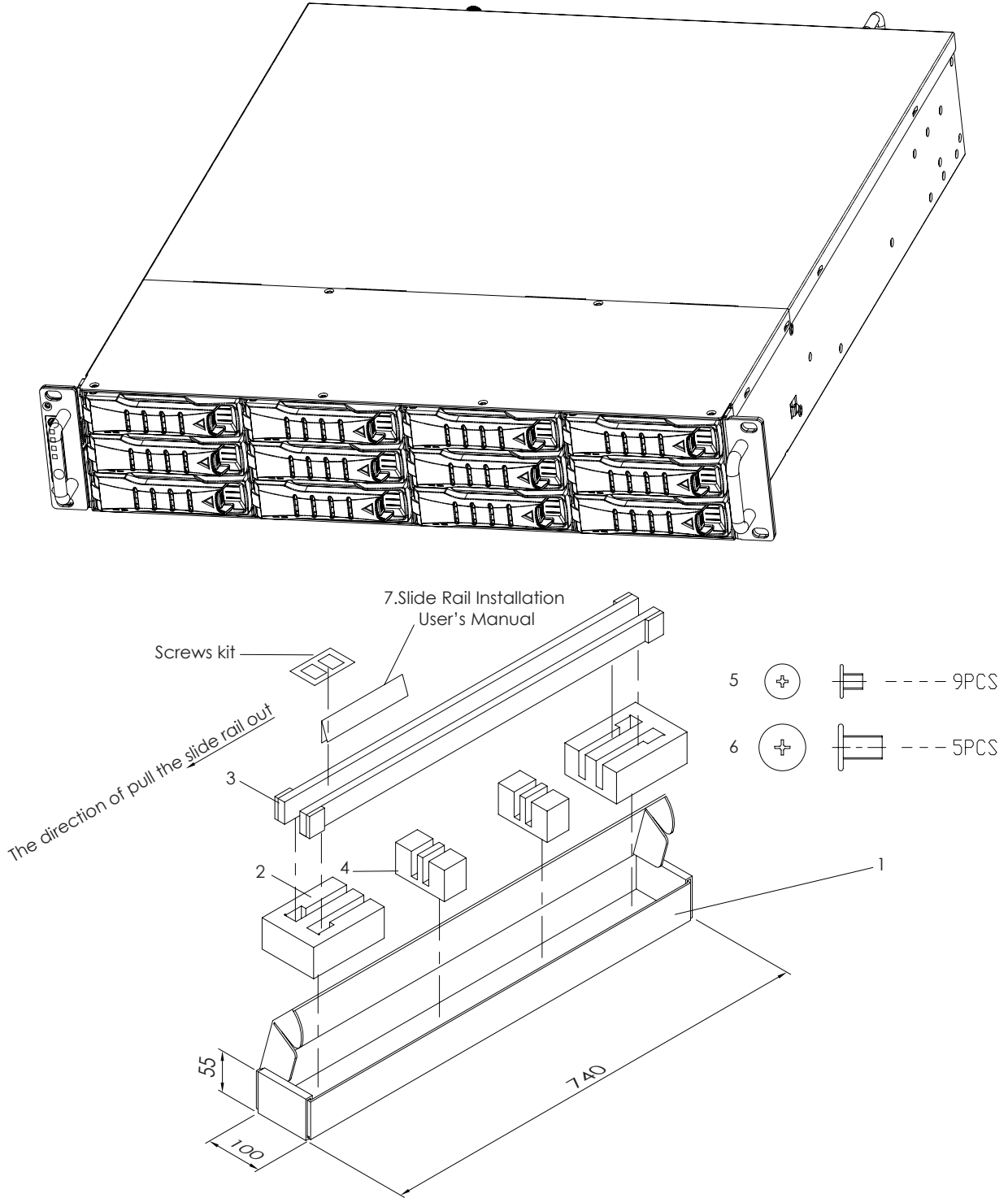

2.7.2 Installing the rear of JBOD onto the Rack

- Secure the adjuster plate on the rack using the screws.
- Insert the slide rail into the adjuster plate and make sure the slide rail is fully hooked into the adjuster plate.

M4 X 6L screws kit * 1sets (10pcs)

Adjuster plate *2 sets

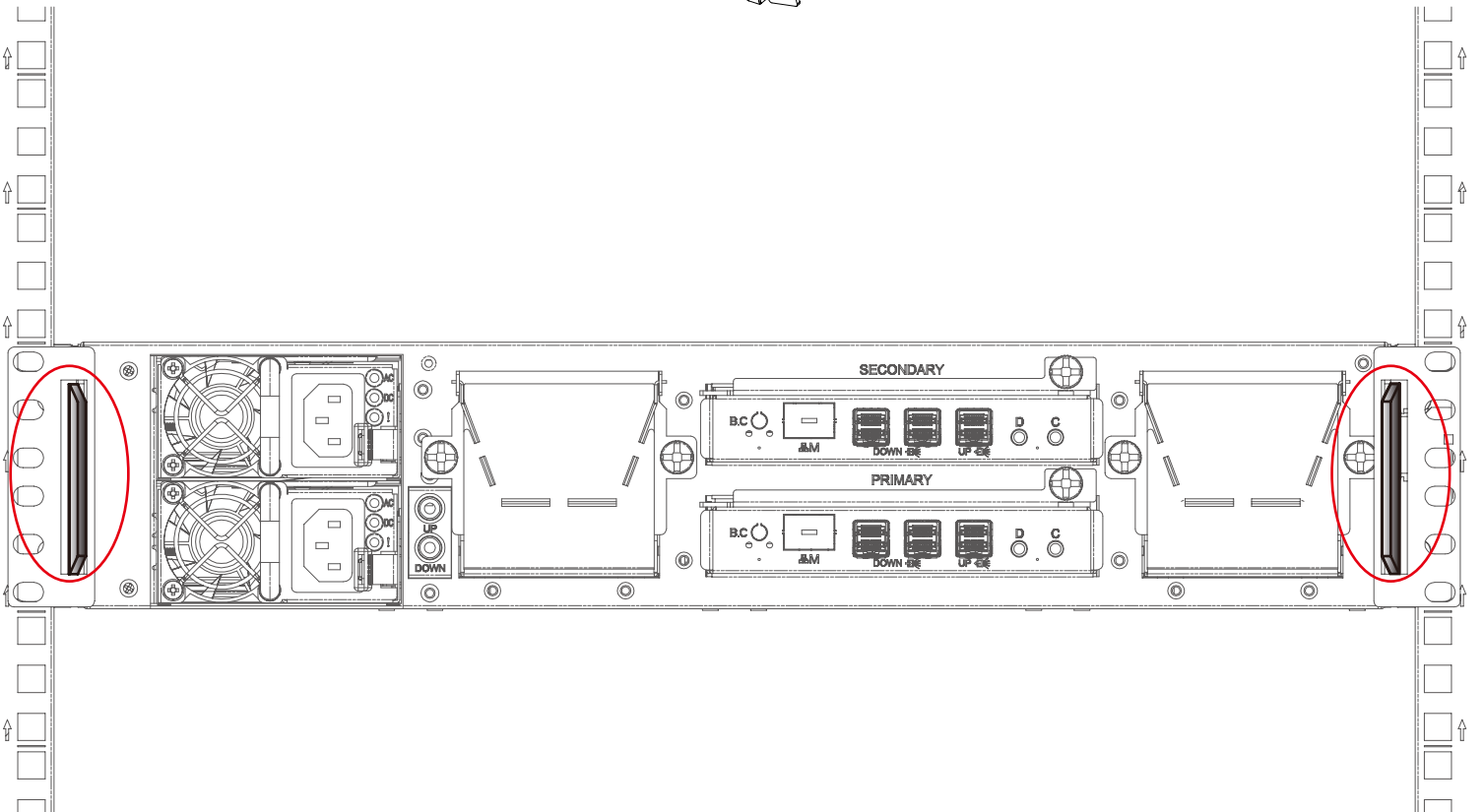
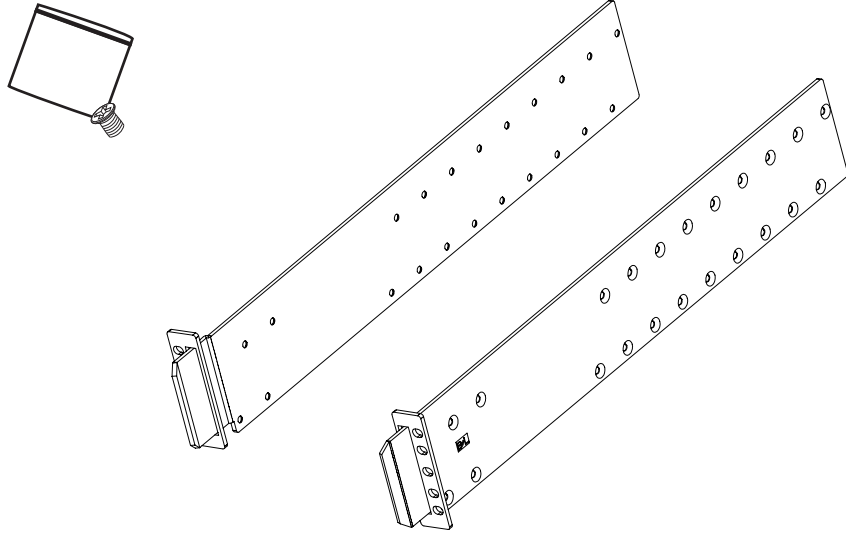

2.7.3 Installing the front of JBOD onto the rack

- Secure the JBOD on the rack using the screws.
- Complete installing JBOD.

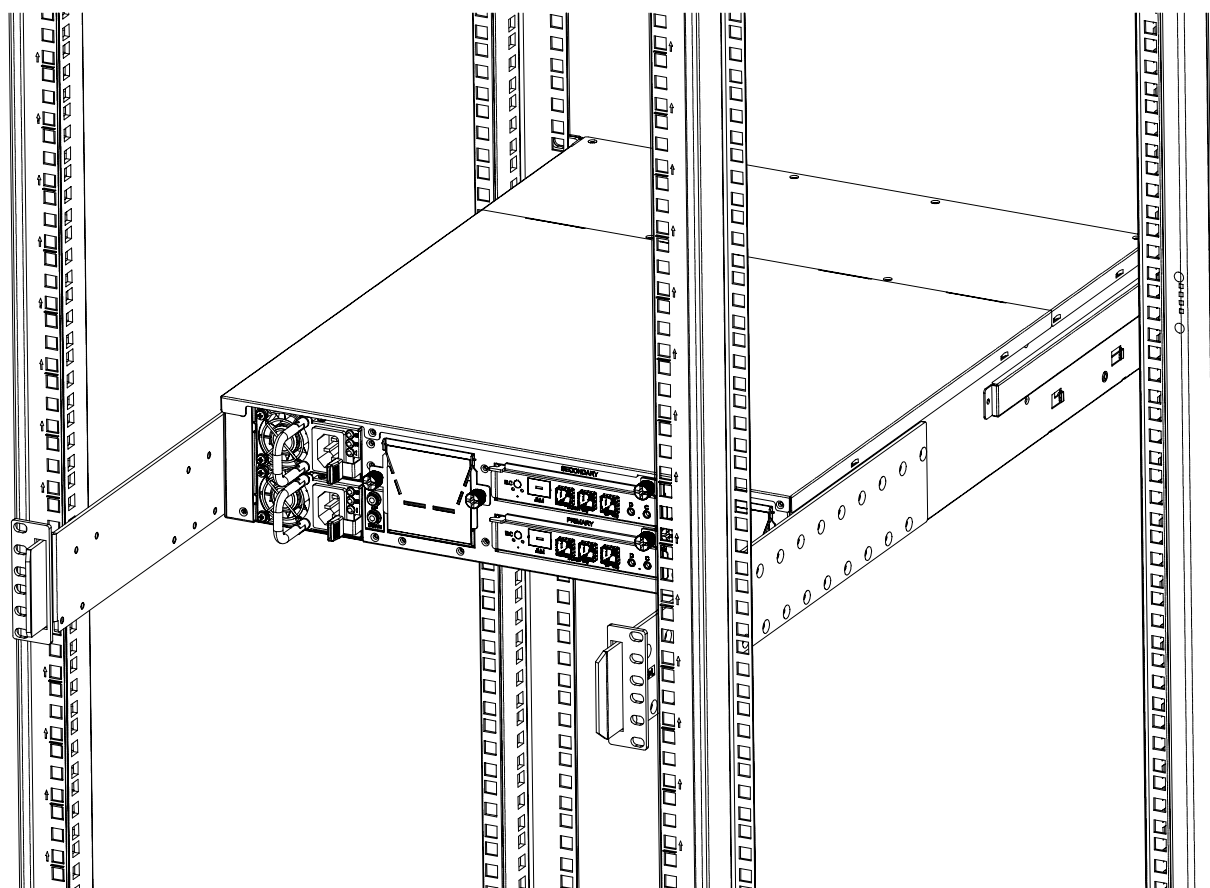
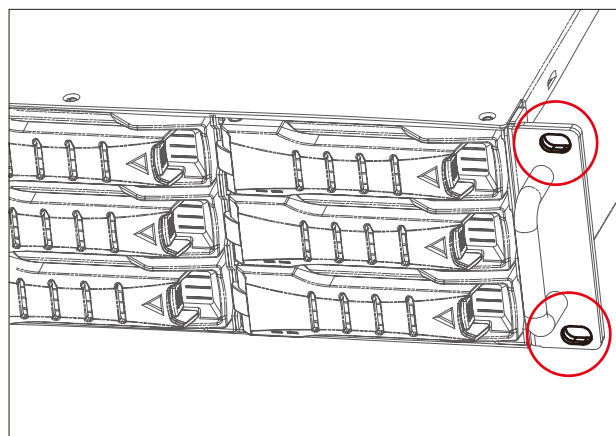
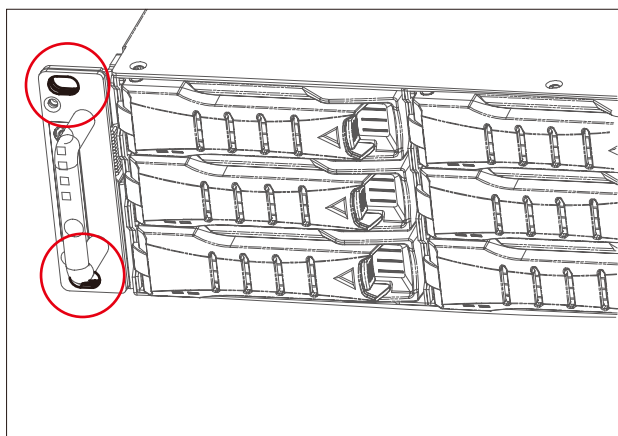

Chapter 3. Sub-System Configuration Setup

3.1 Supported Configuration On Host

Supported Configuration

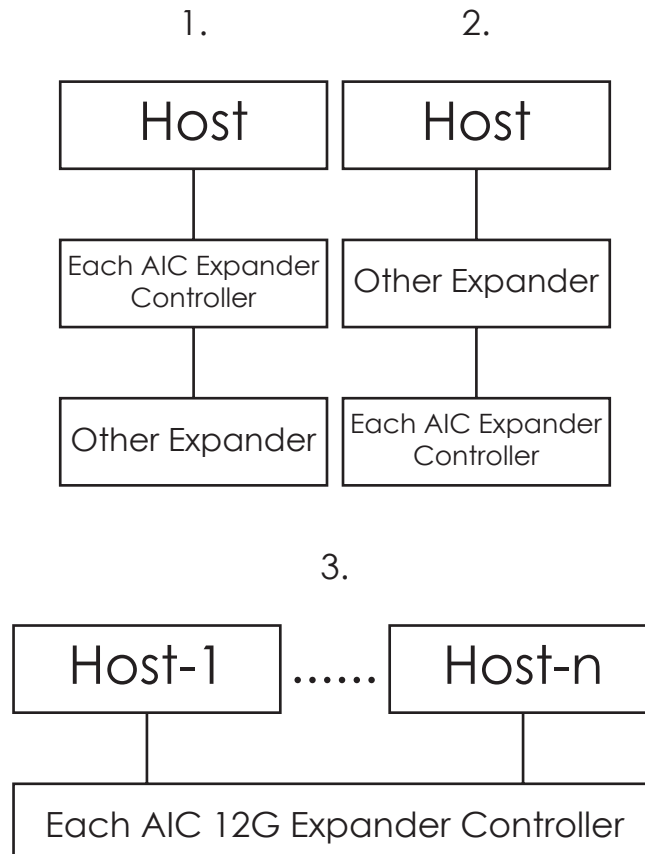

NOTE :

TO HAVE MULTIPLE HOST ACCESS SUPPORT (THE HOST NUMBER CAN BE UP TO THE NUMBER OF WIDE PORTS ON EACH AIC 12G EXPANDER CONTROLLER), ONLY THE FOLLOWING DRIVES ARE SUPPORTED FOR SHARED ACCESS:

1. SAS DRIVE
2. SATA DRIVE WITH AN INTERPOSER WHICH PROVIDES SATA-TO-SAS CONVERSION

3.2 Utility Set up on Host

Step 1: Set up host RS232 connection

Set up RS232 connection application into your host as shown in the example process below.

For example:

OS: Microsoft Windows Server 2008

RS232 connection application: Hyperterminal

Step 2: Install HyperTrm.exe

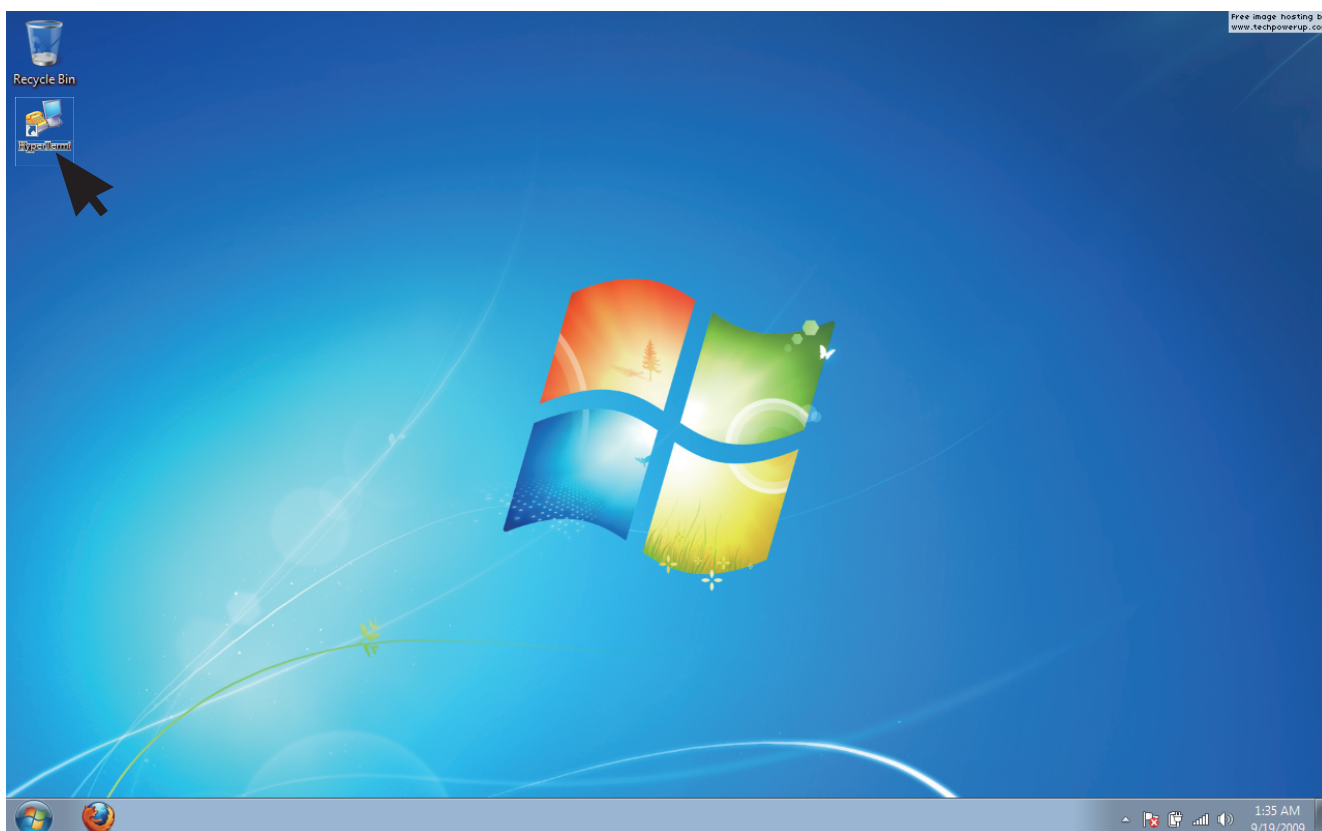

Chapter 3 Sub-System configuration Setup

Step 3: Enter a new name for the icon in the field below and click OK.

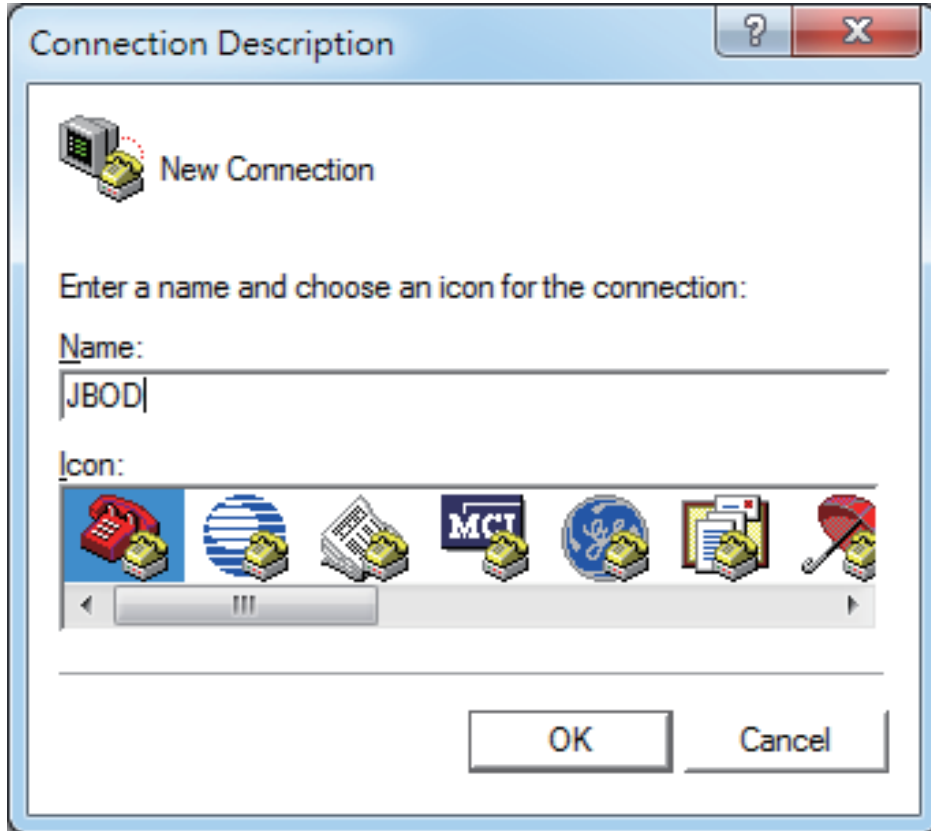

Step 4: Connect by using selecting an option in the drop down menu circled in red below (we selected COM2 in this example) and click OK.

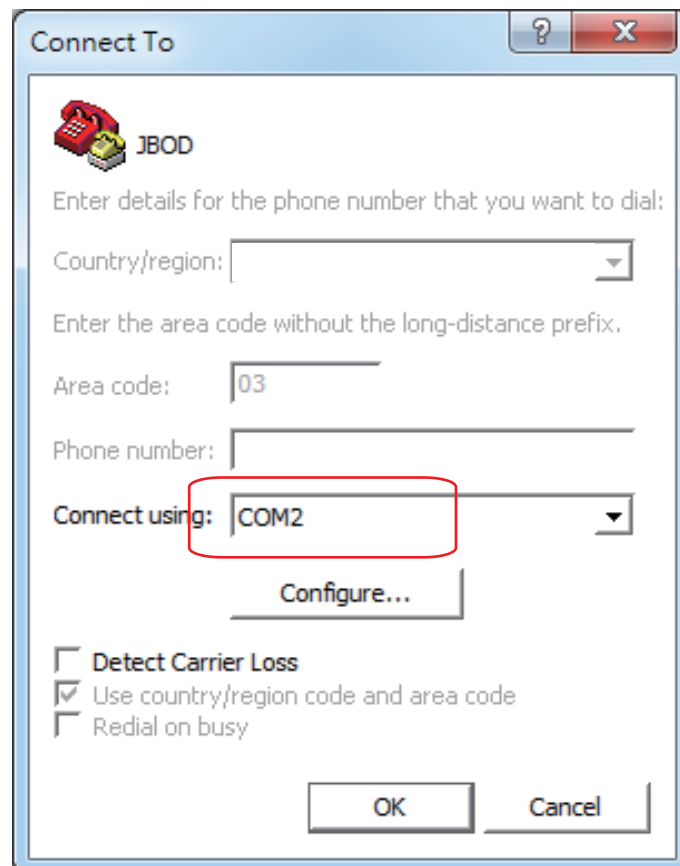

Chapter 3 Sub-System configuration Setup

Step 5: For “Bits per second”, select 38400. For “Flow control”, select: None. Click OK when you have finished your selections.

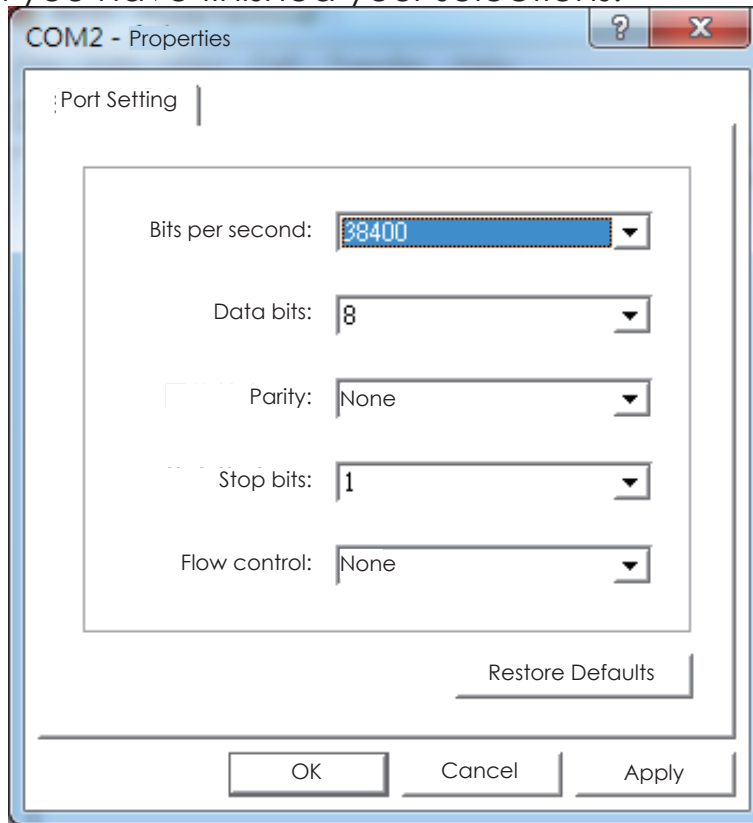

Step 6 : Set up is complete. The diagram below depicts what screen should be displayed.

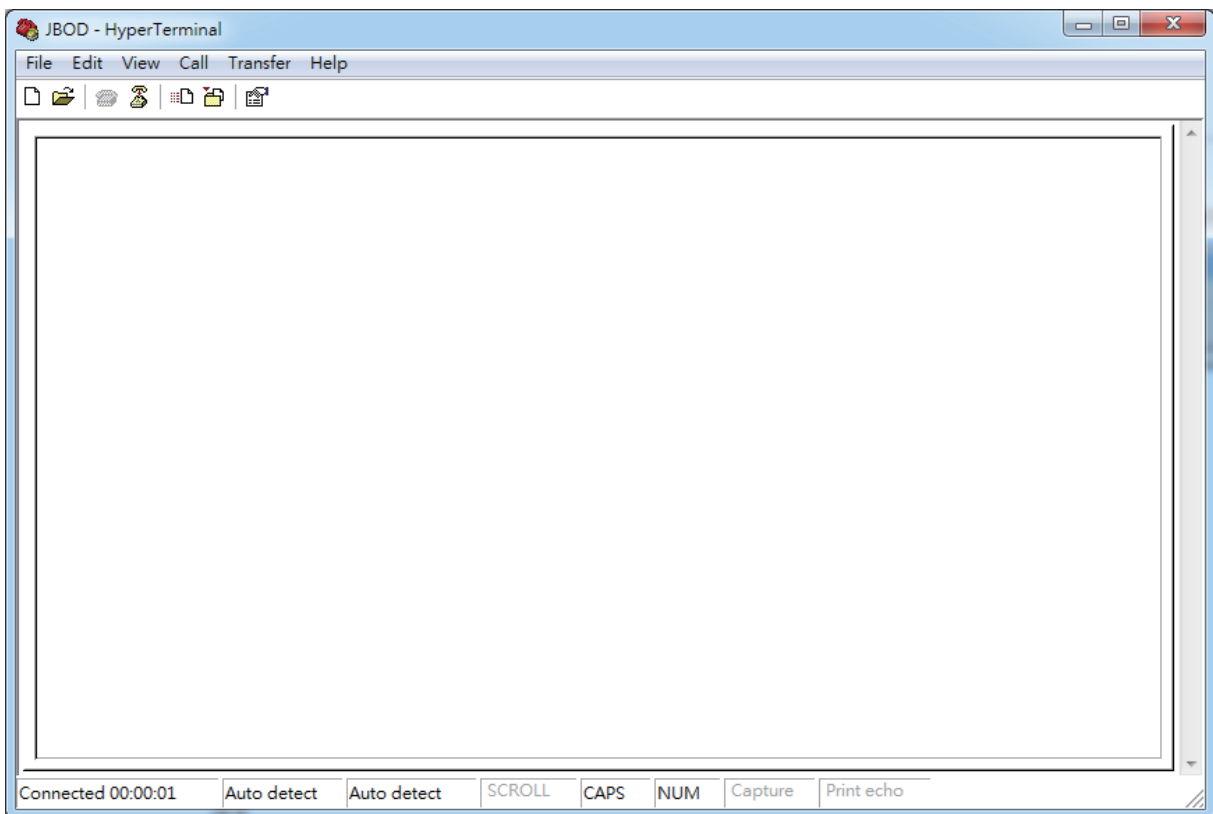

3.3 Connect Host to JBOD via RS232

Use a RS-232 DB9 cable connect the console port of JBOD with host's PC COM port (see figures below for DB9 RS-232 cable and SAS expander COM port).

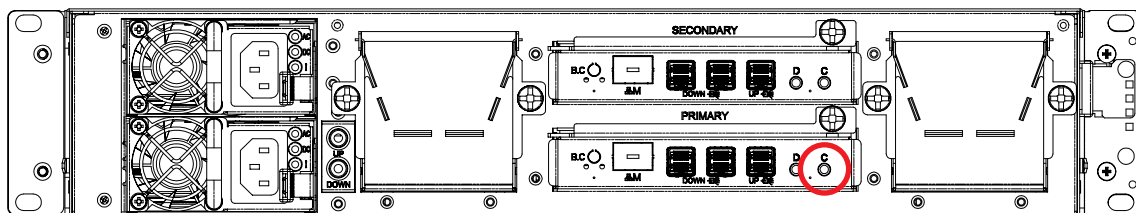
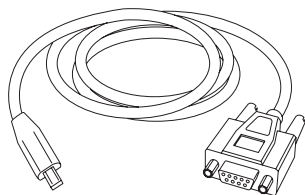

3.4 Configure command Line Interface Operation

3.4.1 How to enable/disable T10 zoning

The default T10 zoning configuration is off.

(A) Check the current zoning state

cmd> phyzone state

Zoning is OFF

(B) Enable zoning

cmd> phyzone on

(C) Disable zoning

cmd> phyzone off

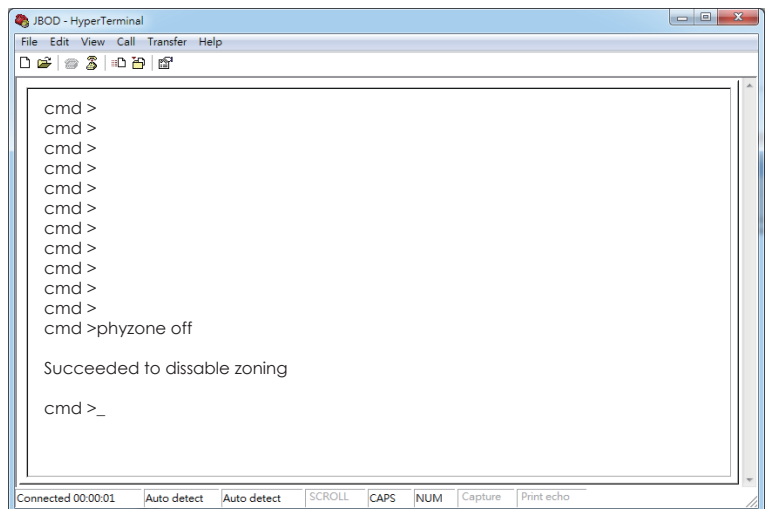
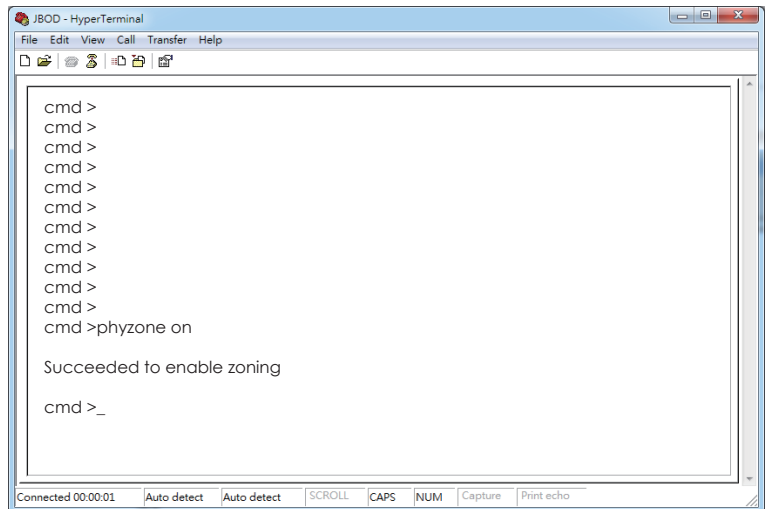
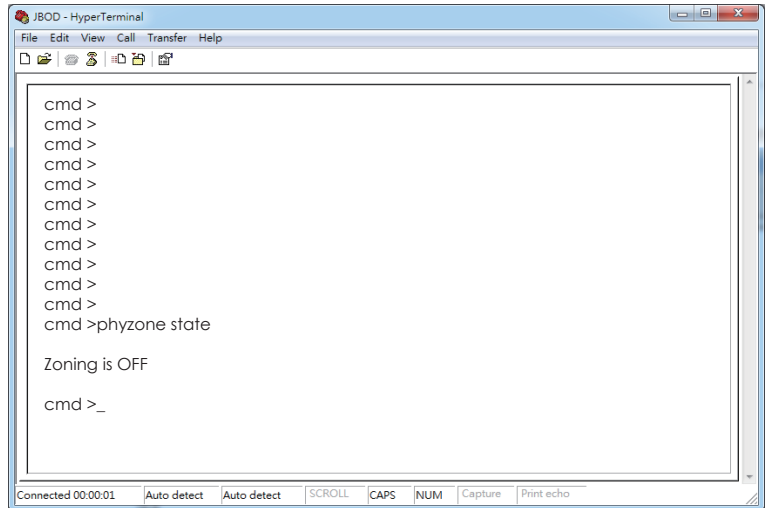

Chapter 3 Sub-System configuration Setup

3.4.2 How to configure T10 zoning

After enabling T10 zoning, five predefined groups are Group1, Group8, Group9, Group10, and Group11.

Each PHY should be in one of the five groups, and all PHYs in a wide port should be in the same group.

Each PHY in Group1 can access any PHY in other groups, and vice versa. Each PHY in Group8 cannot access any PHY in Group9, and vice versa.

The command syntax is "phyzone phy_index group". The following example shows how to setup one drive accessed only the first port and another drive accessed only by the second port.

The configuration for the example is

(A) PHY0 - PHY3 for the first wide port

(B) PHY4 - PHY7 for the second wide port

(C) PHY12 - PHY35 for drive

Step 1: Read the current group for PHY4

```
cmd> phyzone 4
```

Phy 4 for Zone Group 1

Step 2: Assign the second port (PHY4 - PHY7) for Group9

```
cmd> phyzone 4 9
```

```
cmd> phyzone 5 9
```

```
cmd> phyzone 6 9
```

```
cmd> phyzone 7 9
```

Step 3: Assign the first port (PHY0 - PHY3) for Group8

```
cmd> phyzone 0 8
```

```
cmd> phyzone 1 8
```

```
cmd> phyzone 2 8
```

```
cmd> phyzone 3 8
```

Step 4: Assign the drive on PHY12 to be accessed only by the first port instead of the second port

```
cmd> phyzone 12 8
```

Step 5: Assign the drive on PHY13 to be accessed only by the second port instead of the first port

```
cmd> phyzone 13 9
```

Step 6: Reset

Chapter 3 Sub-System configuration Setup

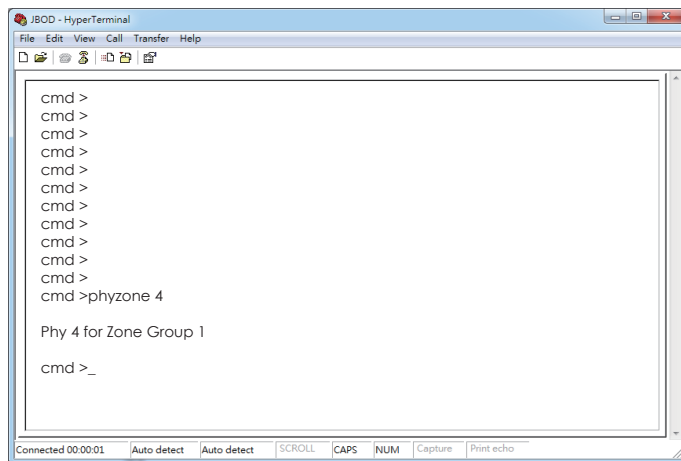

```
cmd >
cmd >
cmd >
cmd >
cmd >
cmd >
cmd >
cmd >
cmd >
cmd >
cmd >
cmd >
cmd >phyzone 4

Phy 4 for Zone Group 1

cmd >_
```

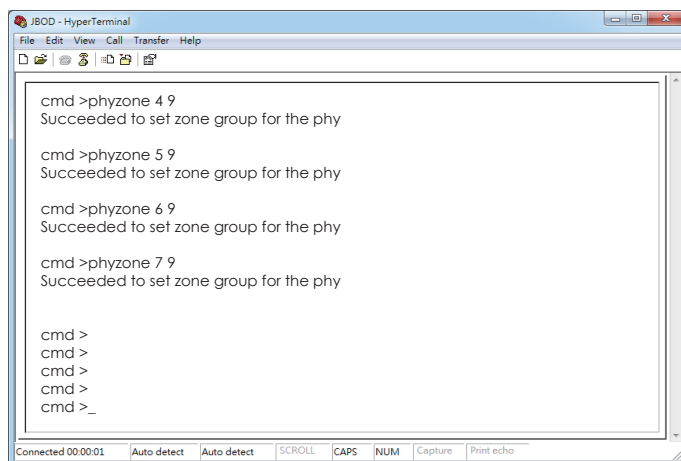

```
cmd >phyzone 4 9
Succeeded to set zone group for the phy

cmd >phyzone 5 9
Succeeded to set zone group for the phy

cmd >phyzone 6 9
Succeeded to set zone group for the phy

cmd >phyzone 7 9
Succeeded to set zone group for the phy

cmd >
cmd >
cmd >
cmd >
cmd >_
```

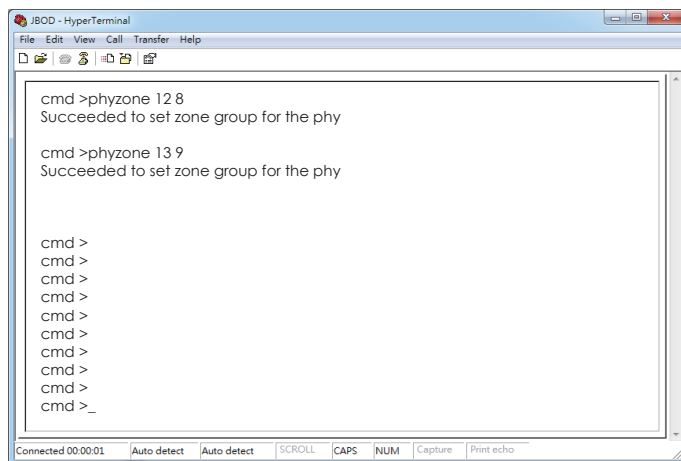

```
cmd >phyzone 12 8
Succeeded to set zone group for the phy

cmd >phyzone 13 9
Succeeded to set zone group for the phy

cmd >
cmd >
cmd >
cmd >
cmd >
cmd >
cmd >
cmd >
cmd >_
```

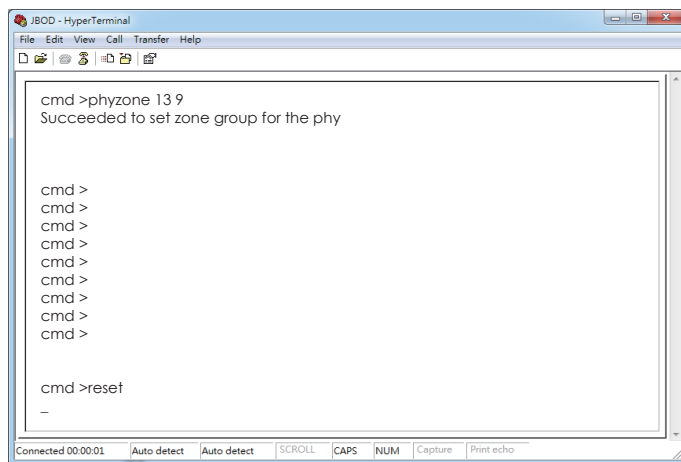

```
cmd >phyzone 13 9
Succeeded to set zone group for the phy

cmd >
cmd >
cmd >
cmd >
cmd >
cmd >
cmd >
cmd >

cmd >reset
-
```

Chapter 3 Sub-System configuration Setup

3.4.3 How to get all revisions in AIC SAS 12G Expander

(A) Expander firmware revision

```
cmd> rev
```

(B) Expander configuration revision

```
cmd> showmfg
```

(C) MCU firmware for managing sensors

```
cmd> sensor
```

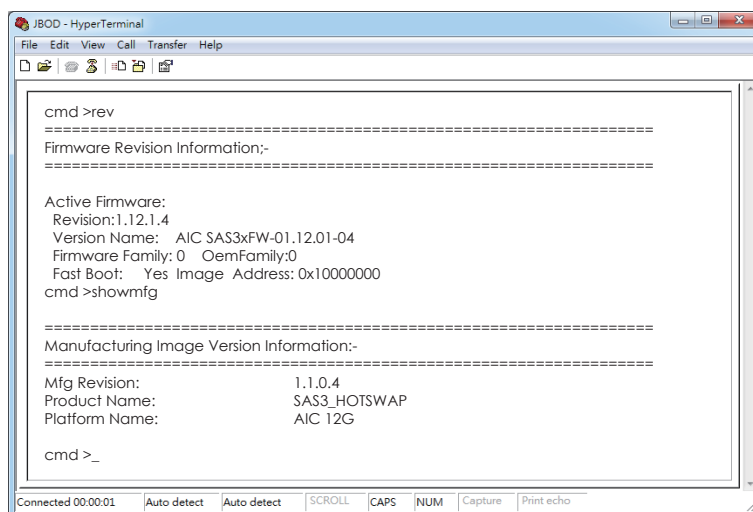

```
JBOD - HyperTerminal
File Edit View Call Transfer Help
cmd >rev
=====
Firmware Revision Information:-
=====
Active Firmware:
Revision:1.12.1.4
Version Name:  AIC SAS3xFW-01.12.01-04
Firmware Family: 0  OemFamily:0
Fast Boot:  Yes Image Address: 0x10000000
cmd >showmfg
=====
Manufacturing Image Version Information:-
=====
Mfg Revision:          1.1.0.4
Product Name:          SAS3_HOTSWAP
Platform Name:         AIC 12G
cmd >_
Connected 00:00:01  Auto detect  Auto detect  SCROLL  CAPS  NUM  Capture  Print echo
```

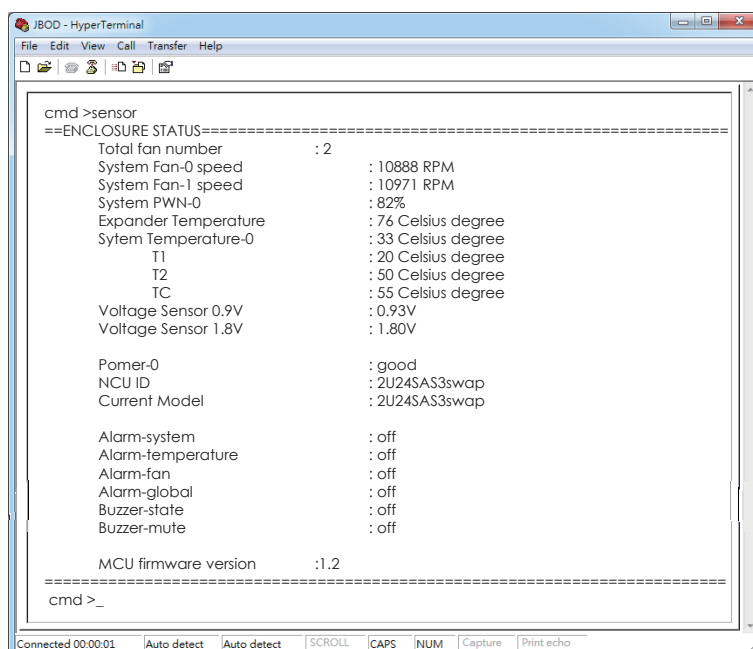

```
JBOD - HyperTerminal
File Edit View Call Transfer Help
cmd >sensor
==ENCLOSURE STATUS==
=====
Total fan number      : 2
System Fan-0 speed    : 10888 RPM
System Fan-1 speed    : 10971 RPM
System PWN-0          : 82%
Expander Temperature  : 76 Celsius degree
System Temperature-0  : 33 Celsius degree
T1                    : 20 Celsius degree
T2                    : 50 Celsius degree
TC                    : 55 Celsius degree
Voltage Sensor 0.9V   : 0.93V
Voltage Sensor 1.8V   : 1.80V

Pomer-0               : good
NCU ID                 : 2U24SAS3swap
Current Model         : 2U24SAS3swap

Alarm-system          : off
Alarm-temperature     : off
Alarm-fan             : off
Alarm-global          : off
Buzzer-state          : off
Buzzer-mute           : off

MCU firmware version  : 1.2
=====
cmd >_
Connected 00:00:01  Auto detect  Auto detect  SCROLL  CAPS  NUM  Capture  Print echo
```

Chapter 3 Sub-System configuration Setup

3.4.4 How to configure temperature sensor

Four temperature settings in Celsius are T1, T2, warning threshold, and alarm (critical) threshold.

(A) Get the current temperature settings

```
cmd> temperature
```

Temperature in Celsius (t1=20 C, t2=55 C, warning=50 C, alarm=55 C)

(B) Set temperature with new T1=18 C, T2=52 C, warning threshold=48 C, and alarm threshold=54 C. The new setting will take effect after reset.

```
cmd> temperature 18 52 48 54
```

```
cmd> reset
```

(C) We also take expander temperature into consideration, and the temperature parameters for expander are fixed. Expander temperature parameters: T1=40, T2=86 (max 115*0.75), and no warning or alarm.

The smart fan feature will use the highest PWM output which is calculated from system and expander temperature parameters.

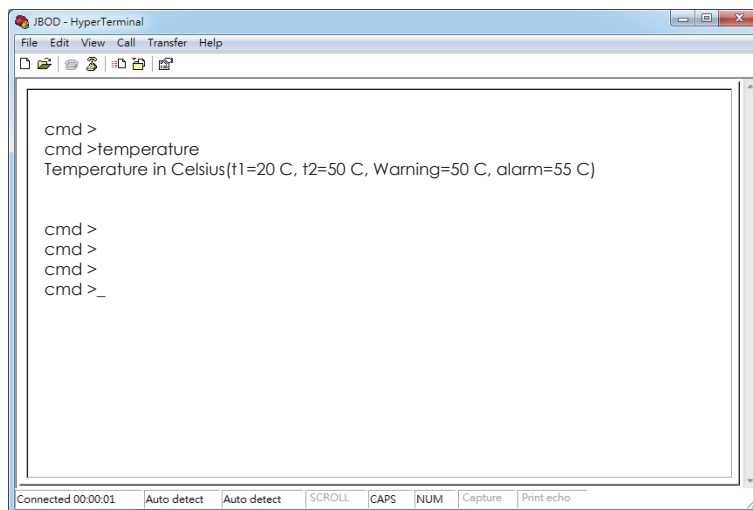

```
JBOD - HyperTerminal
File Edit View Call Transfer Help
cmd >
cmd >temperature
Temperature in Celsius(t1=20 C, t2=50 C, Warning=50 C, alarm=55 C)

cmd >
cmd >
cmd >
cmd >_
Connected 00:00:01 Auto detect Auto detect SCROLL CAPS NUM Capture Print echo
```

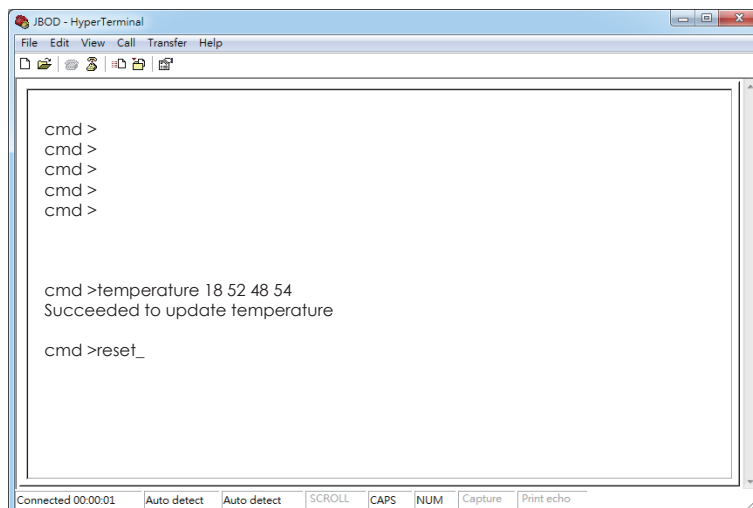

```
JBOD - HyperTerminal
File Edit View Call Transfer Help
cmd >
cmd >
cmd >
cmd >
cmd >

cmd >temperature 18 52 48 54
Succeeded to update temperature

cmd >reset_
Connected 00:00:01 Auto detect Auto detect SCROLL CAPS NUM Capture Print echo
```

Chapter 3 Sub-System configuration Setup

3.4.5 How to configure enclosure address

(A) Get the current enclosure address

```
cmd> enclosure_addr
```

```
Enclosure Address: 0x500605B0000272BF
```

(B) Set the enclosure address with 0x500605B0000272BF. The new setting will take effect after reset.

```
cmd> enclosure_addr 500605B0000272BF
```

```
cmd> reset
```

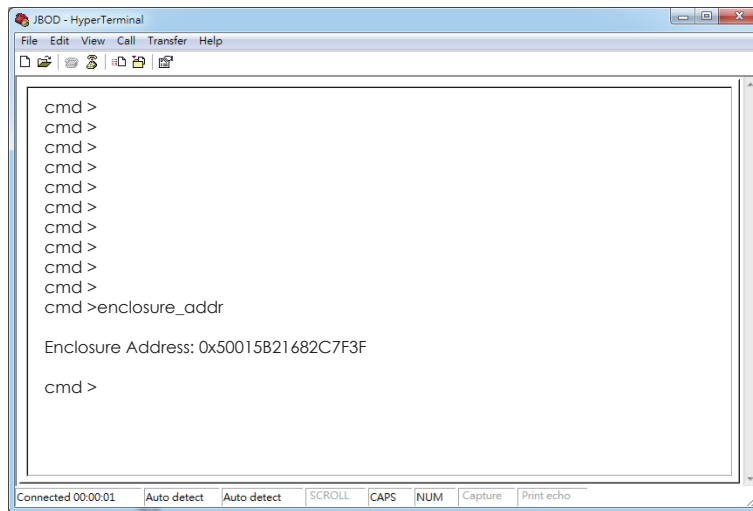

```
JBOD - HyperTerminal
File Edit View Call Transfer Help
cmd >
cmd >
cmd >
cmd >
cmd >
cmd >
cmd >
cmd >
cmd >
cmd >
cmd >enclosure_addr

Enclosure Address: 0x50015B21682C7F3F

cmd >
```

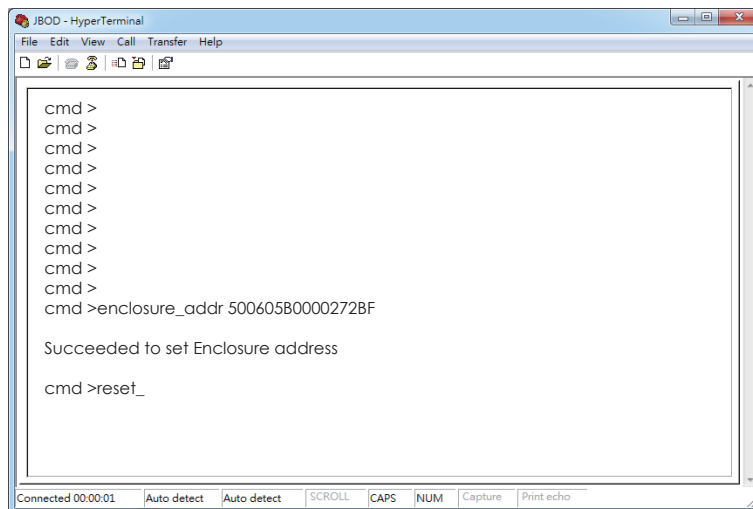

```
JBOD - HyperTerminal
File Edit View Call Transfer Help
cmd >
cmd >
cmd >
cmd >
cmd >
cmd >
cmd >
cmd >
cmd >
cmd >enclosure_addr 500605B0000272BF

Succeeded to set Enclosure address

cmd >reset_
```

Chapter 3 Sub-System configuration Setup

3.4.6 How to configure standby timer for all disk drives

This feature is applicable for SAS/SATA drives. Standby timer is in units of minutes. Setting standby timer with 0 minute disables this feature.

(A) Get current standby timer

```
cmd> standby_timer
```

```
Standby Timer : 0 minutes
```

(B) Set the standby timer with 10 minutes. The new setting will take effect after reset.

```
cmd> standby_timer 10
```

```
cmd> reset
```

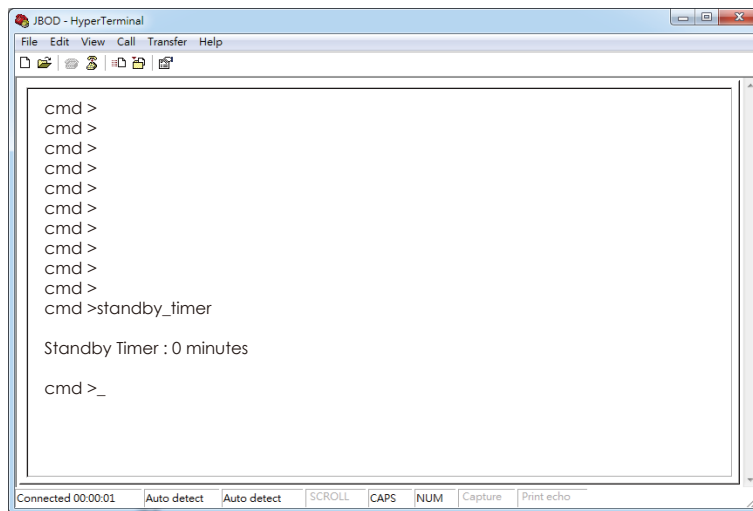

```
JBOD - HyperTerminal
File Edit View Call Transfer Help
Standby Timer : 0 minutes
cmd >
cmd >
cmd >
cmd >
cmd >
cmd >
cmd >
cmd >
cmd >
cmd >
cmd >
cmd >standby_timer
Standby Timer : 0 minutes
cmd >_
Connected 00:00:01 Auto detect Auto detect SCROLL CAPS NUM Capture Print echo
```

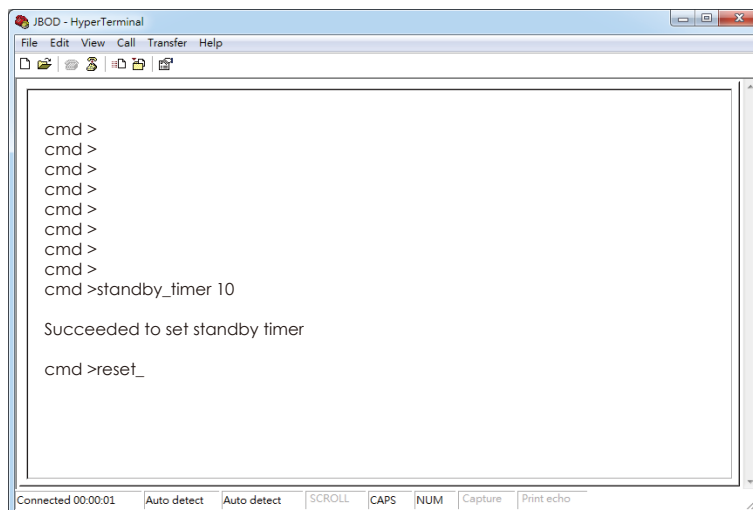

```
JBOD - HyperTerminal
File Edit View Call Transfer Help
Succeeded to set standby timer
cmd >
cmd >
cmd >
cmd >
cmd >
cmd >
cmd >
cmd >
cmd >standby_timer 10
Succeeded to set standby timer
cmd >reset_
Connected 00:00:01 Auto detect Auto detect SCROLL CAPS NUM Capture Print echo
```

3.4.7 How to configure wide port checker

This feature is applicable for SAS drives instead of SATA drives. If there is no connection with any active SAS initiator by checking all wide ports, AIC Expander Controller stops all attached SAS drives to save power consumption of SAS drives. Otherwise, AIC Expander Controller starts all attached SAS drives to provide drive access service to any active SAS initiator.

(A) Get the current state of wide port checker

```
cmd> check_wide_port  
Checking wide port is OFF
```

(B) Enable checking wide port. The new setting will take effect after reset.

```
cmd> check_wide_port on  
cmd> reset
```

(C) Disable checking wide port. The new setting will take effect after reset.

```
cmd> check_wide_port off  
cmd> reset
```

Chapter 3 Sub-System configuration Setup

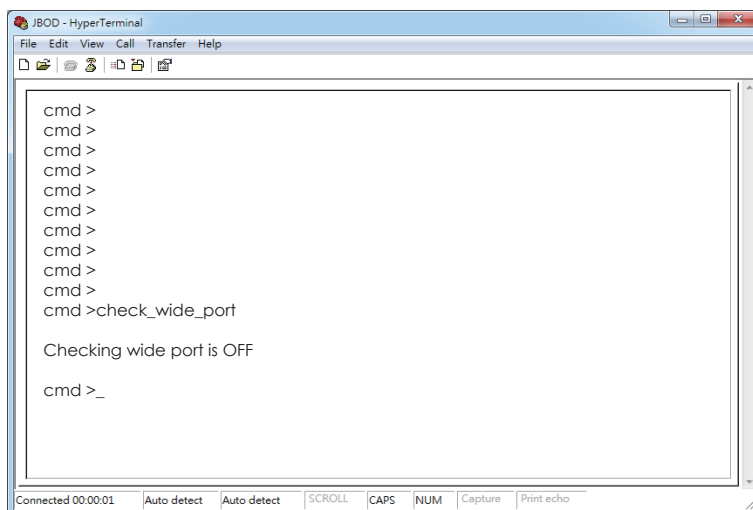

```
JBOD - HyperTerminal
File Edit View Call Transfer Help
cmd >
cmd >
cmd >
cmd >
cmd >
cmd >
cmd >
cmd >
cmd >
cmd >
cmd >
cmd >check_wide_port

Checking wide port is OFF

cmd >_

Connected 00:00:01 Auto detect Auto detect SCROLL CAPS NUM Capture Print echo
```

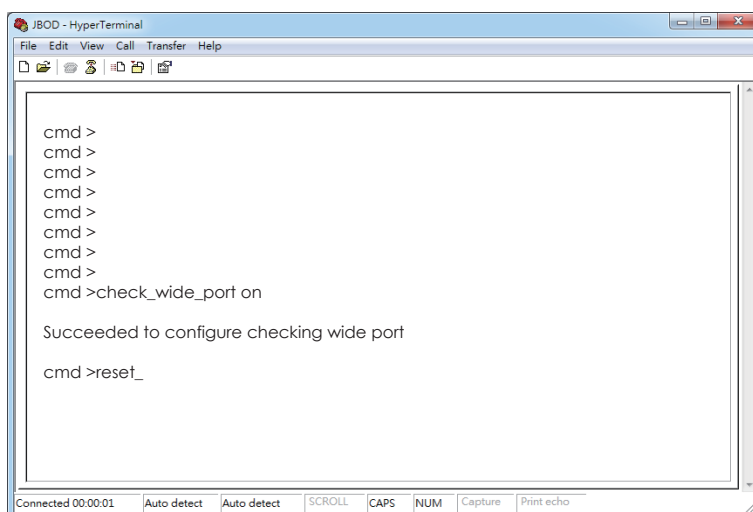

```
JBOD - HyperTerminal
File Edit View Call Transfer Help
cmd >
cmd >
cmd >
cmd >
cmd >
cmd >
cmd >
cmd >
cmd >
cmd >check_wide_port on

Succeeded to configure checking wide port

cmd >reset_

Connected 00:00:01 Auto detect Auto detect SCROLL CAPS NUM Capture Print echo
```

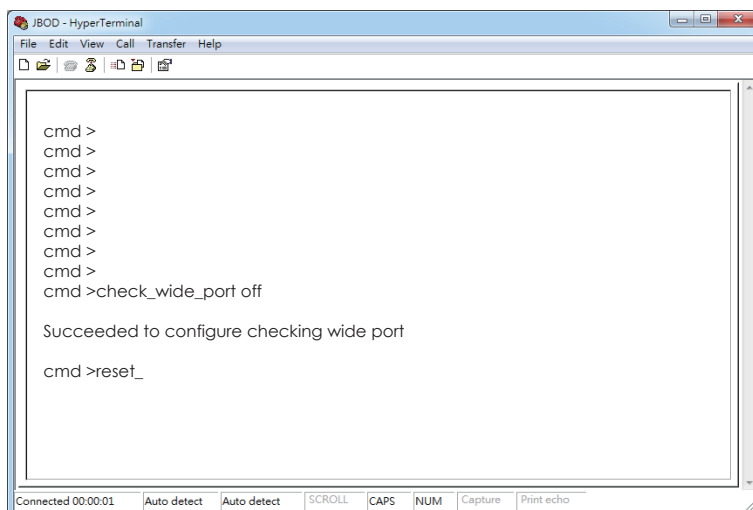

```
JBOD - HyperTerminal
File Edit View Call Transfer Help
cmd >
cmd >
cmd >
cmd >
cmd >
cmd >
cmd >
cmd >
cmd >
cmd >check_wide_port off

Succeeded to configure checking wide port

cmd >reset_

Connected 00:00:01 Auto detect Auto detect SCROLL CAPS NUM Capture Print echo
```

3.4.9 How to turn on/off the power of a drive slot

The "DEVICE OFF" for a drive slot is defined in the bit4, byte3 of the "Array Device Slot control element" in the SES-3 specification. Set the bit to turn off a slot power, and vice versa. Please install a software package "sg3_utils" on your host computer, and have a SAS HBA and a cable to connect your host with the expander. We use Linux for example.

(A) Show the device for AIC Expander Controller (canister)

```
$ sg_map -i  
/dev/sg2 AIC 12G 2U24SAS3swap 0c01
```

(B) Get the current state of a slot power. The "Device off=0" means the slot power is on.

```
$ sg_ses --page=2 /dev/sg2  
Element 0 descriptor:  
App client bypass B=0, Fault sensed=0, Fault reqstd=0, Device off=0
```

(C) Get the descriptor of a slot power

```
$ sg_ses --page=7 /dev/sg2  
Element 0 descriptor: Disk001
```

(D) Turn off a slot power

```
$ sg_ses --descriptor=Disk001 --set=3:4:1 /dev/sg2
```

(E) Turn on a slot power

```
$ sg_ses --descriptor=Disk001 --clear=3:4:1 /dev/sg2
```

```

Applications Places System
root@localhost:~/Desktop
File Edit View Search Terminal Help
[root@localhost Desktop]# sg_map -i
/dev/sg0 /dev/sda HITACHI HUC109090CSS600 A2D0
/dev/sg1 /dev/sdb HITACHI HUC109090CSS600 A2D0
/dev/sg2 /dev/sdc HITACHI HUC109090CSS600 A2D0
/dev/sg3 /dev/sdd HITACHI HUC109090CSS600 A2D0
/dev/sg4 /dev/sde HITACHI HUC109090CSS600 A2D0
/dev/sg5 /dev/sdf HITACHI HUC109090CSS600 A2D0
/dev/sg6 /dev/sdg HITACHI HUC109090CSS600 A2D0
/dev/sg7 /dev/sdh HITACHI HUC109090CSS600 A2D0
/dev/sg8 /dev/sdi HITACHI HUC109090CSS600 A2D0
/dev/sg9 /dev/sdj HITACHI HUC109090CSS600 A2D0
/dev/sg10 /dev/sdk HITACHI HUC109090CSS600 A2D0
/dev/sg11 /dev/sdl HITACHI HUC109090CSS600 A2D0
/dev/sg12 /dev/sdm HITACHI HUC109090CSS600 A2D0
/dev/sg13 /dev/sdn HITACHI HUC109090CSS600 A2D0
/dev/sg14 /dev/sdo HITACHI HUC109090CSS600 A2D0
/dev/sg15 /dev/sdp HITACHI HUC109090CSS600 A2D0
/dev/sg16 /dev/sdq HITACHI HUC109090CSS600 A2D0
/dev/sg17 /dev/sdr HITACHI HUC109090CSS600 A2D0
/dev/sg18 /dev/sds HITACHI HUC109090CSS600 A2D0
/dev/sg19 /dev/sdt HITACHI HUC109090CSS600 A2D0
/dev/sg20 /dev/sdu HITACHI HUC109090CSS600 A2D0
/dev/sg21 /dev/sdv HITACHI HUC109090CSS600 A2D0
/dev/sg22 /dev/sdw HITACHI HUC109090CSS600 A2D0
/dev/sg23 /dev/sdx HITACHI HUC109090CSS600 A2D0
/dev/sg24 AIC 12G 2U24SAS3swap 0c01
/dev/sg25 /dev/sdy ATA ST9160511NS SN03
[root@localhost Desktop]#

```

```

root@localhost:~/Desktop
File Edit View Search Terminal Help
[root@localhost Desktop]# sg_ses --page=2 /dev/sg24
AIC 12G 2U24SAS3swap 0c01
Primary enclosure logical identifier (hex): 50015b21682c5a3f
Enclosure Status diagnostic page:
INVOP=0, INFO=0, NON-CRIT=0, CRIT=0, UNRECOV=0
generation code: 0x0
status descriptor list
Element type: Array device slot, subenclosure id: 0 [ti=0]
Overall descriptor:
  Predicted failure=0, Disabled=0, Swap=0, status: Unsupported
  OK=0, Reserved device=0, Hot spare=0, Cons check=0
  In crit array=0, In failed array=0, Rebuild/remap=0, R/R abort=0
  App client bypass A=0, Do not remove=0, Enc bypass A=0, Enc bypass B=0
  Ready to insert=0, RMV=0, Ident=0, Report=0
  App client bypass B=0, Fault sensed=0, Fault reqstd=0, Device off=0
  Bypassed A=0, Bypassed B=0, Dev bypassed A=0, Dev bypassed B=0
Element 0 descriptor:
  Predicted failure=0, Disabled=0, Swap=0, status: Not installed
  OK=0, Reserved device=0, Hot spare=0, Cons check=0
  In crit array=0, In failed array=0, Rebuild/remap=0, R/R abort=0
  App client bypass A=0, Do not remove=0, Enc bypass A=0, Enc bypass B=0
  Ready to insert=0, RMV=0, Ident=0, Report=0
  App client bypass B=0, Fault sensed=0, Fault reqstd=0, Device off=1
  Bypassed A=0, Bypassed B=0, Dev bypassed A=0, Dev bypassed B=0
Element 1 descriptor:
  Predicted failure=0, Disabled=0, Swap=0, status: OK
  OK=0, Reserved device=0, Hot spare=0, Cons check=0
  In crit array=0, In failed array=0, Rebuild/remap=0, R/R abort=0
  App client bypass A=0, Do not remove=0, Enc bypass A=0, Enc bypass B=0
  Ready to insert=0, RMV=0, Ident=0, Report=0
  App client bypass B=0, Fault sensed=0, Fault reqstd=0, Device off=0
  Bypassed A=0, Bypassed B=0, Dev bypassed A=0, Dev bypassed B=0
Element 2 descriptor:
  Predicted failure=0, Disabled=0, Swap=0, status: OK
  OK=0, Reserved device=0, Hot spare=0, Cons check=0

```

```
root@localhost:~/Desktop
File Edit View Search Terminal Help
[root@localhost Desktop]# sg_ses --page=7 /dev/sg24
AIC 12G 2U24SAS3swap 0c01
Primary enclosure logical identifier (hex): 50015b21682c5a3f
Element Descriptor In diagnostic page:
generation code: 0x0
element descriptor by type list
Element type: Array device slot, subenclosure id: 0 [ti=0]
Overall descriptor: ArrayDevicesInSubEnclsr0
Element 0 descriptor: Disk001
Element 1 descriptor: Disk002
Element 2 descriptor: Disk003
Element 3 descriptor: Disk004
Element 4 descriptor: Disk005
Element 5 descriptor: Disk006
Element 6 descriptor: Disk007
Element 7 descriptor: Disk008
Element 8 descriptor: Disk009
Element 9 descriptor: Disk010
Element 10 descriptor: Disk011
Element 11 descriptor: Disk012
Element 12 descriptor: Disk013
Element 13 descriptor: Disk014
Element 14 descriptor: Disk015
Element 15 descriptor: Disk016
Element 16 descriptor: Disk017
Element 17 descriptor: Disk018
Element 18 descriptor: Disk019
Element 19 descriptor: Disk020
Element 20 descriptor: Disk021
Element 21 descriptor: Disk022
Element 22 descriptor: Disk023
Element 23 descriptor: Disk024
Element type: Temperature sensor, subenclosure id: 0 [ti=1]
Overall descriptor: TempSensorsInSubEnclsr0
Element 0 descriptor: SystemTempSense01
Element type: Voltage sensor, subenclosure id: 0 [ti=2]
Overall descriptor: VoltageSensorsInSubEnclsr0
Element 0 descriptor: VoltageSense01
Element 1 descriptor: VoltageSense02
Element type: Enclosure, subenclosure id: 0 [ti=3]
Overall descriptor: EnclosureElementInSubEnclsr0
Element 0 descriptor: EnclosureElement01
Element type: Power supply, subenclosure id: 0 [ti=4]
Overall descriptor: PowerSupplyInSubEnclsr0
root@localhost:~/Des...
```



A terminal window titled "root@localhost:~/Desktop" with a menu bar containing "File", "Edit", "View", "Search", "Terminal", and "Help". The terminal prompt is "[root@localhost Desktop]#". The command "sg_ses --descriptor=Disk001 --set=3:4:1 /dev/sg24" is entered and the cursor is at the end of the line. A mouse cursor is visible in the terminal area.

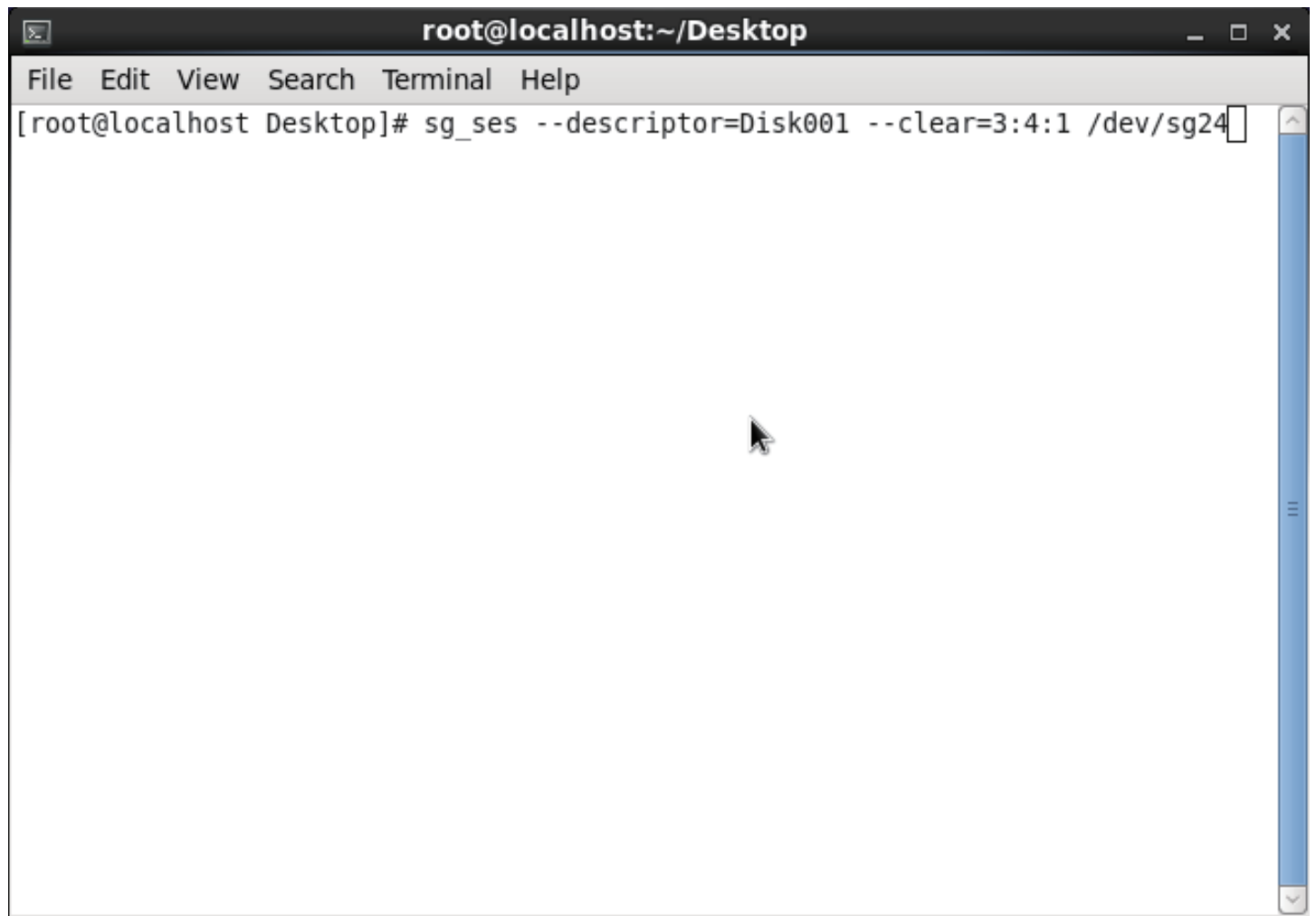

A terminal window titled "root@localhost:~/Desktop" with a menu bar containing "File", "Edit", "View", "Search", "Terminal", and "Help". The terminal prompt is "[root@localhost Desktop]#". The command "sg_ses --descriptor=Disk001 --clear=3:4:1 /dev/sg24" is entered and the cursor is at the end of the line. A mouse cursor is visible in the center of the terminal area.

3.4.10 How to power off/on all disk drives manually

The "RQST ON" for Power Supply is defined in the bit5, byte3 of the "Power Supply control element" in the SES-3 specification. Clear the bit to power off all disk drives. Set the bit to power on all disk drives. Please install the software package "sg3_utils" on your host computer, and have a SAS HBA and a cable to connect your host with the expander. We use Linux for example.

(A) Show the device for AIC Expander Controller (canister)

```
$ sg_map -i  
/dev/sg2 AIC 12G 2U24SAS3swap 0c01
```

(B) Power off all disk drives

```
$ sg_ses --descriptor=DiskPowerSupply --clear=3:5:1 /dev/sg2
```

(C) Power on all disk drives

```
$ sg_ses --descriptor=DiskPowerSupply --set=3:5:1 /dev/sg2
```



```

Applications Places System
root@localhost:~/Desktop
File Edit View Search Terminal Help
[root@localhost Desktop]# sg_map -i
/dev/sg0 /dev/sda HITACHI HUC109090CSS600 A2D0
/dev/sg1 /dev/sdb HITACHI HUC109090CSS600 A2D0
/dev/sg2 /dev/sdc HITACHI HUC109090CSS600 A2D0
/dev/sg3 /dev/sdd HITACHI HUC109090CSS600 A2D0
/dev/sg4 /dev/sde HITACHI HUC109090CSS600 A2D0
/dev/sg5 /dev/sdf HITACHI HUC109090CSS600 A2D0
/dev/sg6 /dev/sdg HITACHI HUC109090CSS600 A2D0
/dev/sg7 /dev/sdh HITACHI HUC109090CSS600 A2D0
/dev/sg8 /dev/sdi HITACHI HUC109090CSS600 A2D0
/dev/sg9 /dev/sdj HITACHI HUC109090CSS600 A2D0
/dev/sg10 /dev/sdk HITACHI HUC109090CSS600 A2D0
/dev/sg11 /dev/sdl HITACHI HUC109090CSS600 A2D0
/dev/sg12 /dev/sdm HITACHI HUC109090CSS600 A2D0
/dev/sg13 /dev/sdn HITACHI HUC109090CSS600 A2D0
/dev/sg14 /dev/sdo HITACHI HUC109090CSS600 A2D0
/dev/sg15 /dev/sdp HITACHI HUC109090CSS600 A2D0
/dev/sg16 /dev/sdq HITACHI HUC109090CSS600 A2D0
/dev/sg17 /dev/sdr HITACHI HUC109090CSS600 A2D0
/dev/sg18 /dev/sds HITACHI HUC109090CSS600 A2D0
/dev/sg19 /dev/sdt HITACHI HUC109090CSS600 A2D0
/dev/sg20 /dev/sdu HITACHI HUC109090CSS600 A2D0
/dev/sg21 /dev/sdv HITACHI HUC109090CSS600 A2D0
/dev/sg22 /dev/sdw HITACHI HUC109090CSS600 A2D0
/dev/sg23 /dev/sdx HITACHI HUC109090CSS600 A2D0
/dev/sg24 AIC 12G 2U24SAS3swap 0c01
/dev/sg25 /dev/sdy ATA ST9160511NS SN03
[root@localhost Desktop]#

```

Chapter 3 Sub-System configuration Setup

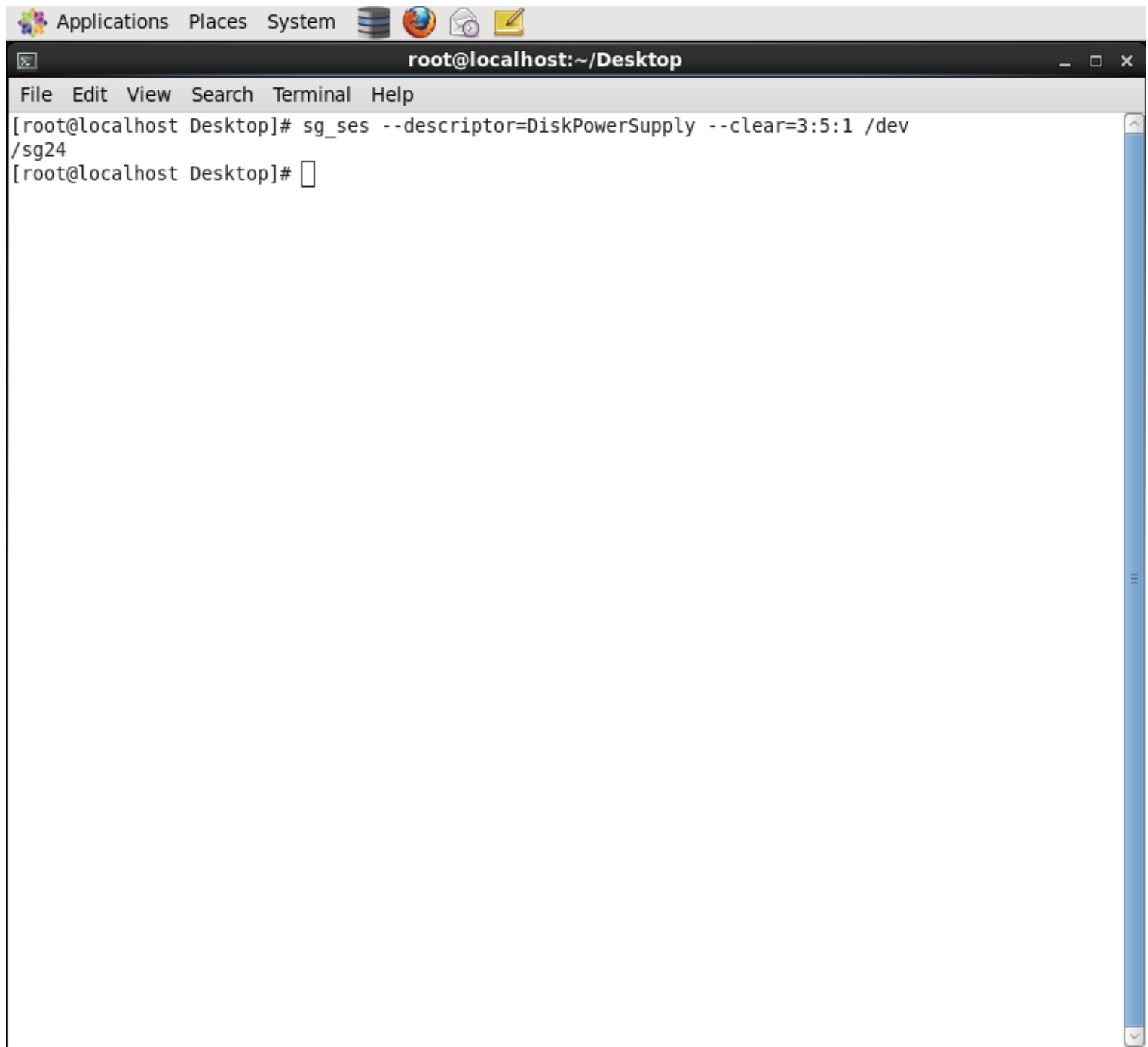

The image shows a terminal window titled "root@localhost:~/Desktop". The window has a menu bar with "File", "Edit", "View", "Search", "Terminal", and "Help". The terminal content shows the following commands and output:

```
[root@localhost Desktop]# sg_ses --descriptor=DiskPowerSupply --clear=3:5:1 /dev  
/sg24  
[root@localhost Desktop]#
```

Chapter 3 Sub-System configuration Setup

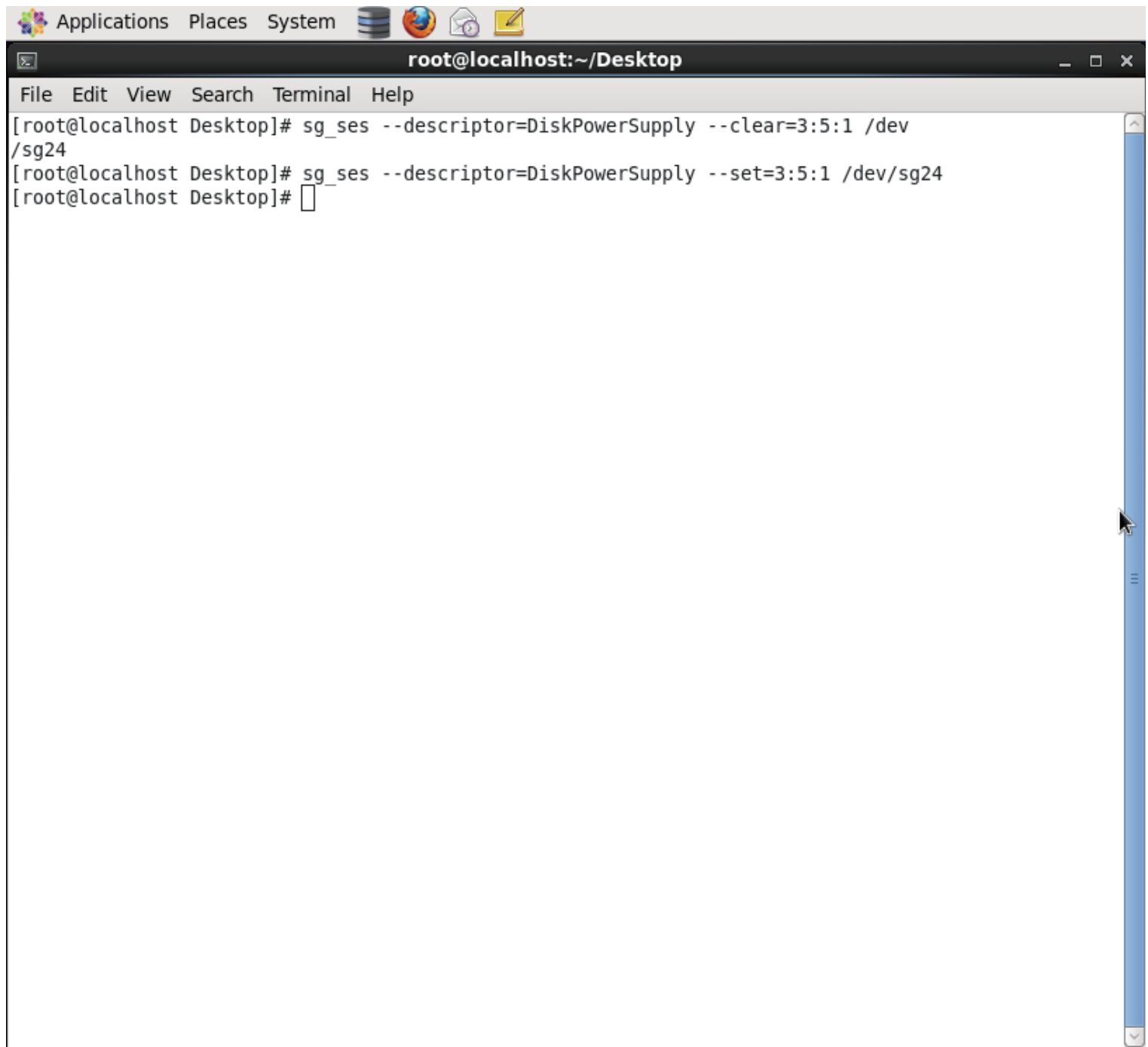
A terminal window titled "root@localhost:~/Desktop" is shown. The window has a menu bar with "File", "Edit", "View", "Search", "Terminal", and "Help". The terminal content shows three lines of command execution:

```
[root@localhost Desktop]# sg_ses --descriptor=DiskPowerSupply --clear=3:5:1 /dev  
/sg24  
[root@localhost Desktop]# sg_ses --descriptor=DiskPowerSupply --set=3:5:1 /dev/sg24  
[root@localhost Desktop]#
```

3.4.11 How to manually change PWM (fan speed) for all Cooling elements

The "RQST IDENT" for Cooling is defined in the bit7, byte1 and the "REQUESTED SPEED CODE" is defined in the bit2 ~ 0, byte3 of the "Cooling control element" in the SES specification. Set "RQST IDENT" bit to disable the smart fan function, and then change PWM or fan speed for all Cooling elements by setting the "REQUESTED SPEED CODE" bits. Clear "RQST IDENT" bit to enable the smart fan function again. Please disable the smart fan function before changing PWM or fan speed. Only Cooling element 0 supports this feature. We use the software package "sg3_utils" on Linux for example, and have a SAS HBA and a cable to connect your host with the expander.

(A) Show the device for AIC Expander Controller (canister)

```
$ sg_map -i
```

```
/dev/sg2 AIC 12G 2U24SAS3swap 0c01
```

(B) Set "RQST IDENT" of Cooling element 0 to disable the smart fan function

```
$ sg_ses --descriptor=SystemCoolingElement01 --set=1:7:1 /dev/sg2
```

(C) Set "REQUESTED SPEED CODE" of Cooling element 0 to change PWM or fan speed for all Cooling elements. Set "REQUESTED SPEED CODE"=7 (100% PWM) for example.

```
$ sg_ses --descriptor=SystemCoolingElement01 --set 3:2:3=7 /dev/sg2
```

REQUESTED SPEED CODE	PWM
7	100%
6	90%
5	80%
4	70%
3	60%
2	50%
1	40%
0	Leave at current speed

Chapter 3 Sub-System configuration Setup

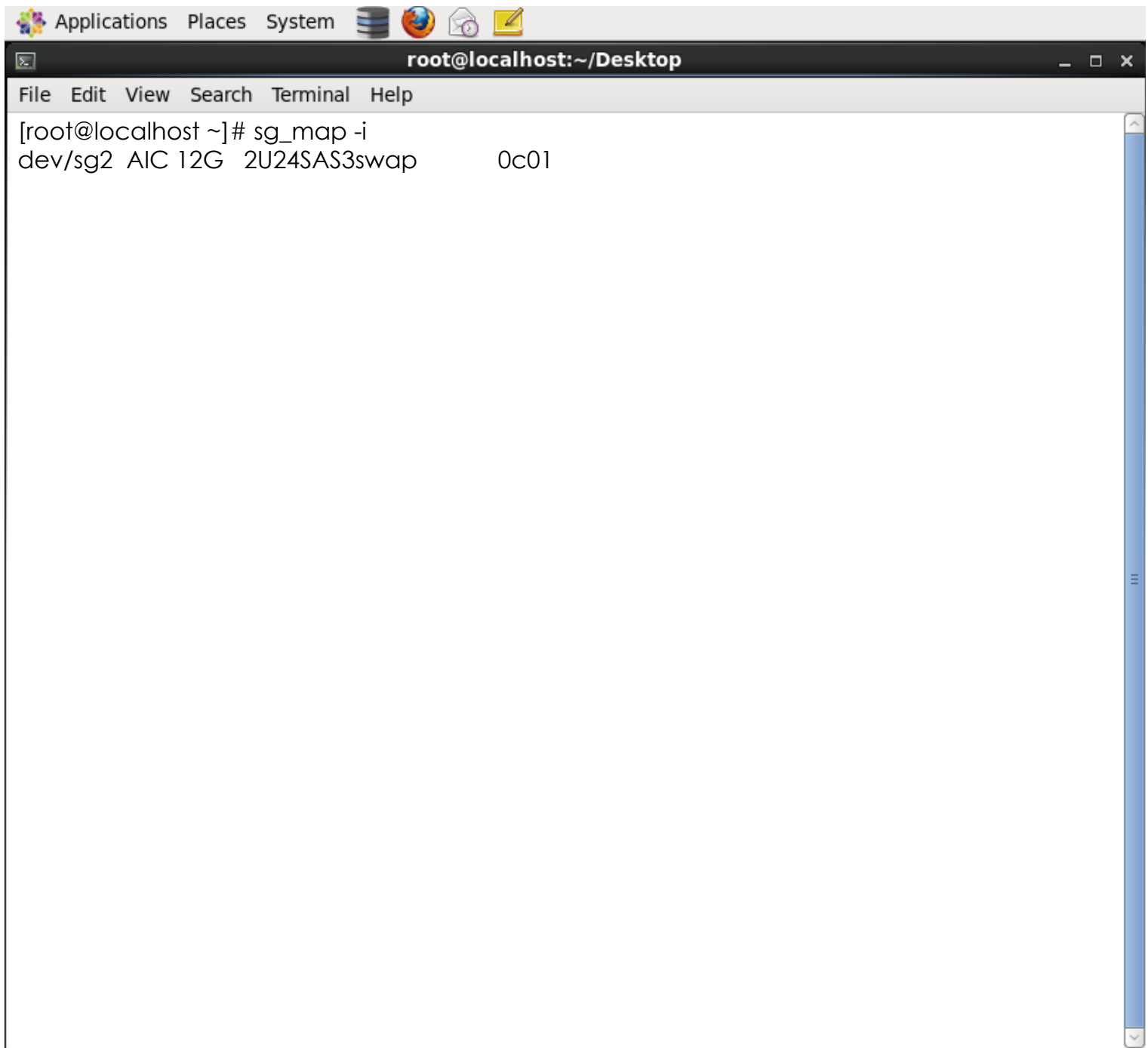

The image shows a terminal window titled "root@localhost:~/Desktop". The window has a menu bar with "File", "Edit", "View", "Search", "Terminal", and "Help". The terminal content shows the command `[root@localhost ~]# sg_map -i` and its output: `dev/sg2 AIC 12G 2U24SAS3swap 0c01`. The terminal has a scroll bar on the right side.

```
root@localhost:~/Desktop
File Edit View Search Terminal Help
[root@localhost ~]# sg_map -i
dev/sg2 AIC 12G 2U24SAS3swap 0c01
```

Chapter 3 Sub-System configuration Setup

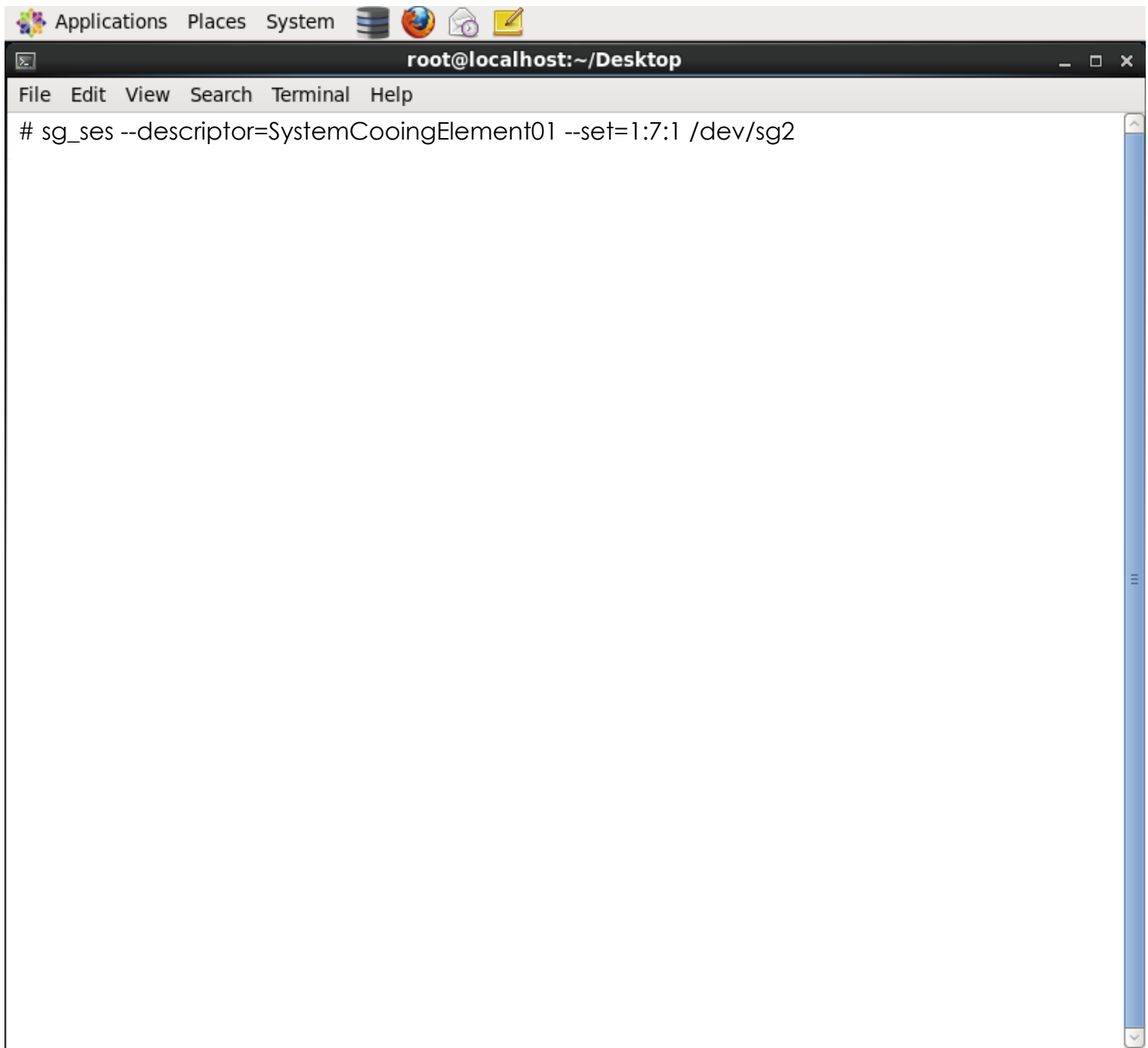
A terminal window titled "root@localhost:~/Desktop" is shown. The window has a menu bar with "File", "Edit", "View", "Search", "Terminal", and "Help". The terminal content shows a command being executed: "# sg_ses --descriptor=SystemCooingElement01 --set=1:7:1 /dev/sg2". The terminal is otherwise empty.

```
root@localhost:~/Desktop
File Edit View Search Terminal Help
# sg_ses --descriptor=SystemCooingElement01 --set=1:7:1 /dev/sg2
```

Chapter 3 Sub-System configuration Setup

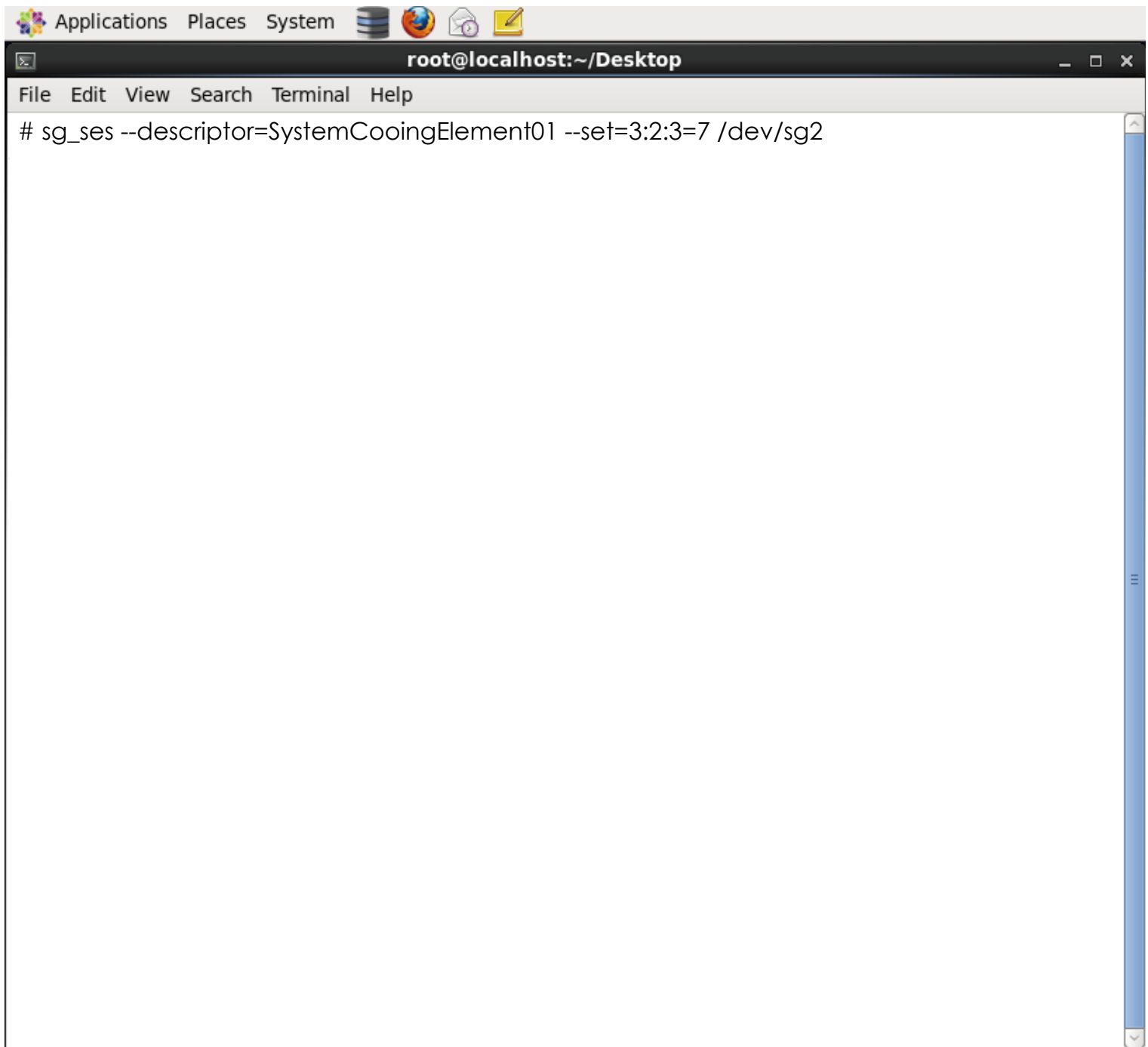
A terminal window titled "root@localhost:~/Desktop" is shown. The window has a menu bar with "File", "Edit", "View", "Search", "Terminal", and "Help". The terminal content shows a command being executed: "# sg_ses --descriptor=SystemCooingElement01 --set=3:2:3=7 /dev/sg2". The terminal has a scroll bar on the right side.

```
root@localhost:~/Desktop
File Edit View Search Terminal Help
# sg_ses --descriptor=SystemCooingElement01 --set=3:2:3=7 /dev/sg2
```

Chapter 3 Sub-System configuration Setup

3.4.12 How to power off/on all disk drives automatically

This feature is applicable for SAS/SATA drives. If there is no connection with any active SAS initiator by checking all wide ports, AIC Expander Controller powers off all attached SAS/SATA drives to save power consumption. Otherwise, AIC Expander Controller powers on all attached SAS/SATA drives to provide drive access service to any active SAS initiator.

(A) Apply the following commands on the COM port.

```
cmd> check_wide_port standby
```

```
cmd> reset
```

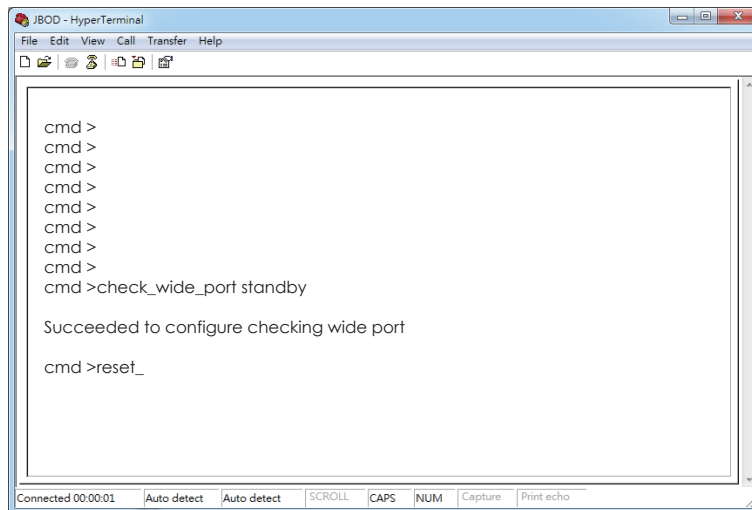
A screenshot of a HyperTerminal window titled ".BOD - HyperTerminal". The window contains a command prompt interface. The text displayed is: "cmd >", "cmd >", "cmd >", "cmd >", "cmd >", "cmd >", "cmd >", "cmd >", "cmd >", "cmd >", "cmd >check_wide_port standby", "Succeeded to configure checking wide port", "cmd >reset_". The status bar at the bottom shows "Connected 00:00:01" and several control buttons: "Auto detect", "Auto detect", "SCROLL", "CAPS", "NUM", "Capture", and "Print echo".

```
.BOD - HyperTerminal
File Edit View Call Transfer Help
cmd >
cmd >
cmd >
cmd >
cmd >
cmd >
cmd >
cmd >
cmd >
cmd >
cmd >check_wide_port standby
Succeeded to configure checking wide port
cmd >reset_
Connected 00:00:01 Auto detect Auto detect SCROLL CAPS NUM Capture Print echo
```

WARNING : THIS FUNCTION IS NOT RECOMMENDED TO USE WITH RAID CARD SINCE RAID CARD LIMITATION.

3.4.13 How to configure power setting

This feature is for restoring on AC power loss. Three supported options are "keep off", "keep on", and "keep last state". The default setting is "keep off".

(A) Get the current power setting

```
cmd> power_setting
```

Power setting: keep off

(B) Set "keep off"

```
cmd> power_setting keep_off
```

(C) Set "keep on"

```
cmd> power_setting keep_on
```

(D) Set "keep last state"

```
cmd> power_setting keep_last_state
```

Chapter 3 Sub-System configuration Setup

3.4.14 How to enable the EDFB function on 12G expander

The default EDFB configuration is off.

Check the current configuration

cmd> edfb

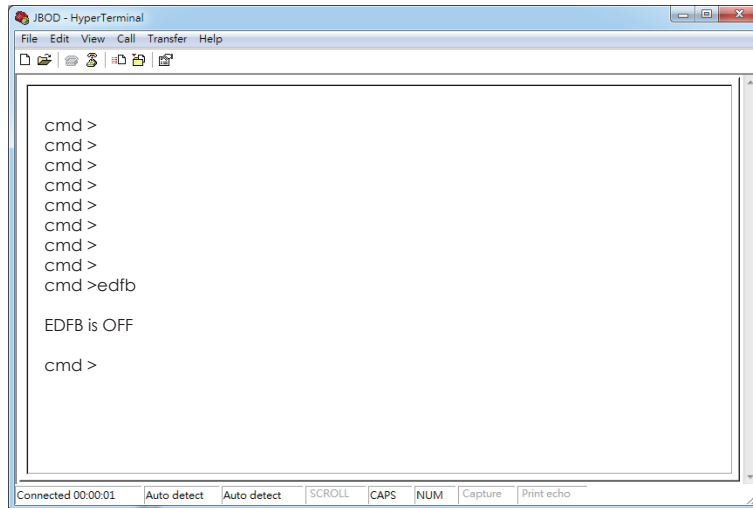

```
cmd >
cmd >
cmd >
cmd >
cmd >
cmd >
cmd >
cmd >
cmd >
cmd >edfb

EDFB is OFF

cmd >
```

Enable the edfb

cmd>edfb on

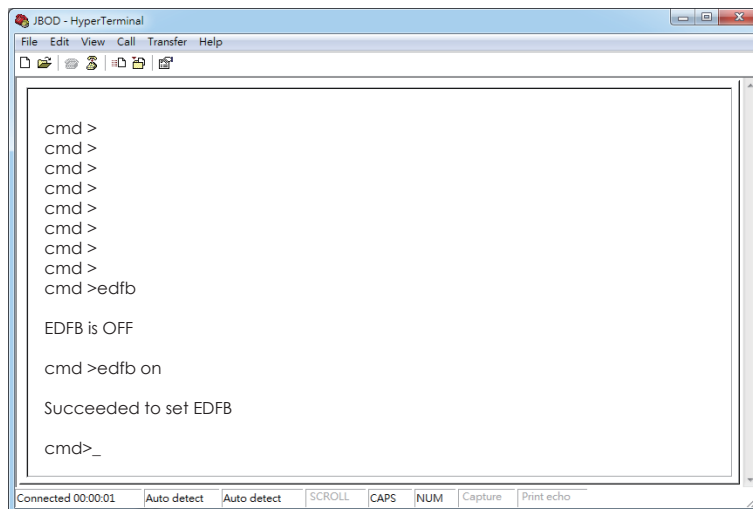

```
cmd >
cmd >
cmd >
cmd >
cmd >
cmd >
cmd >
cmd >
cmd >
cmd >edfb

EDFB is OFF

cmd >edfb on

Succeeded to set EDFB

cmd>_
```

Disable the edfb

cmd> edfb off

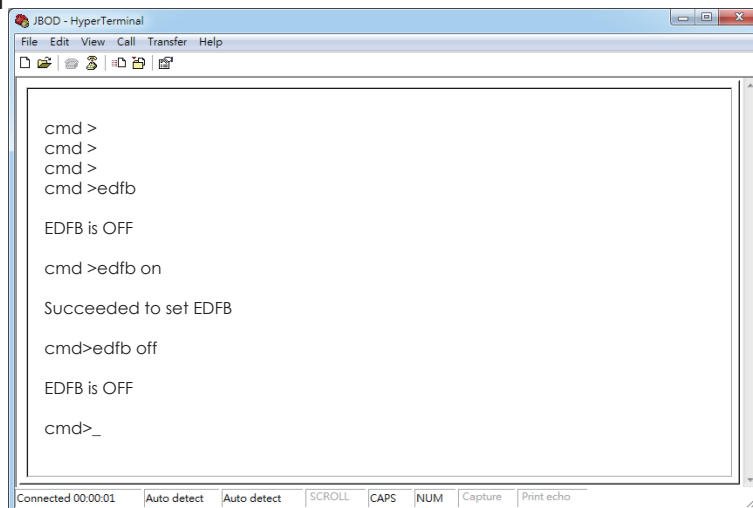

```
cmd >
cmd >
cmd >
cmd >edfb

EDFB is OFF

cmd >edfb on

Succeeded to set EDFB

cmd>edfb off

EDFB is OFF

cmd>_
```

3.5 Power on/off the enclosure via RS232

The RS232 setting - baud rate: 9600 bps, data bits: 8, parity: odd, stop bits: 1, flow control: none

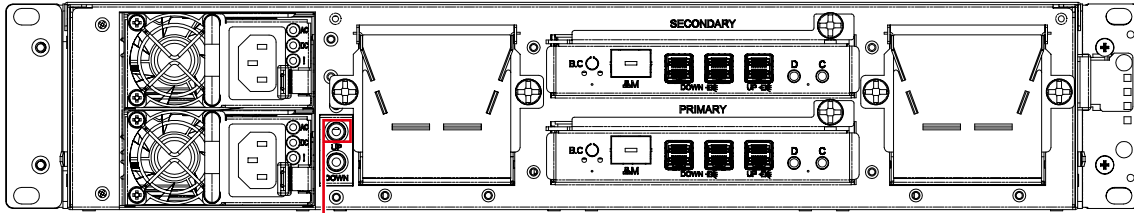

Serial port for Remote JBOD Power on & off
Up – to Host or JBOD

The power-on command is "RemoteStart\n" where "\n" means Carriage Return and Linefeed. The power-off command is "RemoteStop\n". When the host RS232 receives "RemoteStart\n" or "RemoteStop\n" from the enclosure after the same command was sent to the enclosure, that means the enclosure accepts the command sent by the host. **The reference script below runs on Linux.**

```
#####
#####
#!/bin/bash
PORT="/dev/ttyS0"
BAUDRATE="9600"
NOFLOW="-ixon -ixoff -crtsets"
SOFTFLOW="ixon ixoff -crtsets"
DEFAULT="-inpck clocal -istrip ignbrk ignpar opost onlcr -iexten"
if [ $# -eq 0 ] ; then
echo "Usage: $0 start/stop"
exit 1
fi
[ ! -e "$PORT" ] && echo "Console closed..."
stty -F $PORT $BAUDRATE cs8 parenb parodd -cstopb $NOFLOW opost onlcr
case $1 in
start)
echo "RemoteStart"
echo -e "\n" > $PORT
echo -e "RemoteStart\n" > $PORT
echo -e "RemoteStart\n" > $PORT
echo -e "RemoteStart\n" > $PORT
echo -e "RemoteStart\n" > $PORT
echo -e "RemoteStart\n" > $PORT
;;
```

Chapter 3 Sub-System configuration Setup

```
stop)
echo "RemoteStop"
echo -e "\n" > $PORT
echo -e "RemoteStop\n" > $PORT
echo -e "RemoteStop\n" > $PORT
```

Chapter 4. BMC Configuration and Settings

4.1 Sensor's location for Fan & Temperature

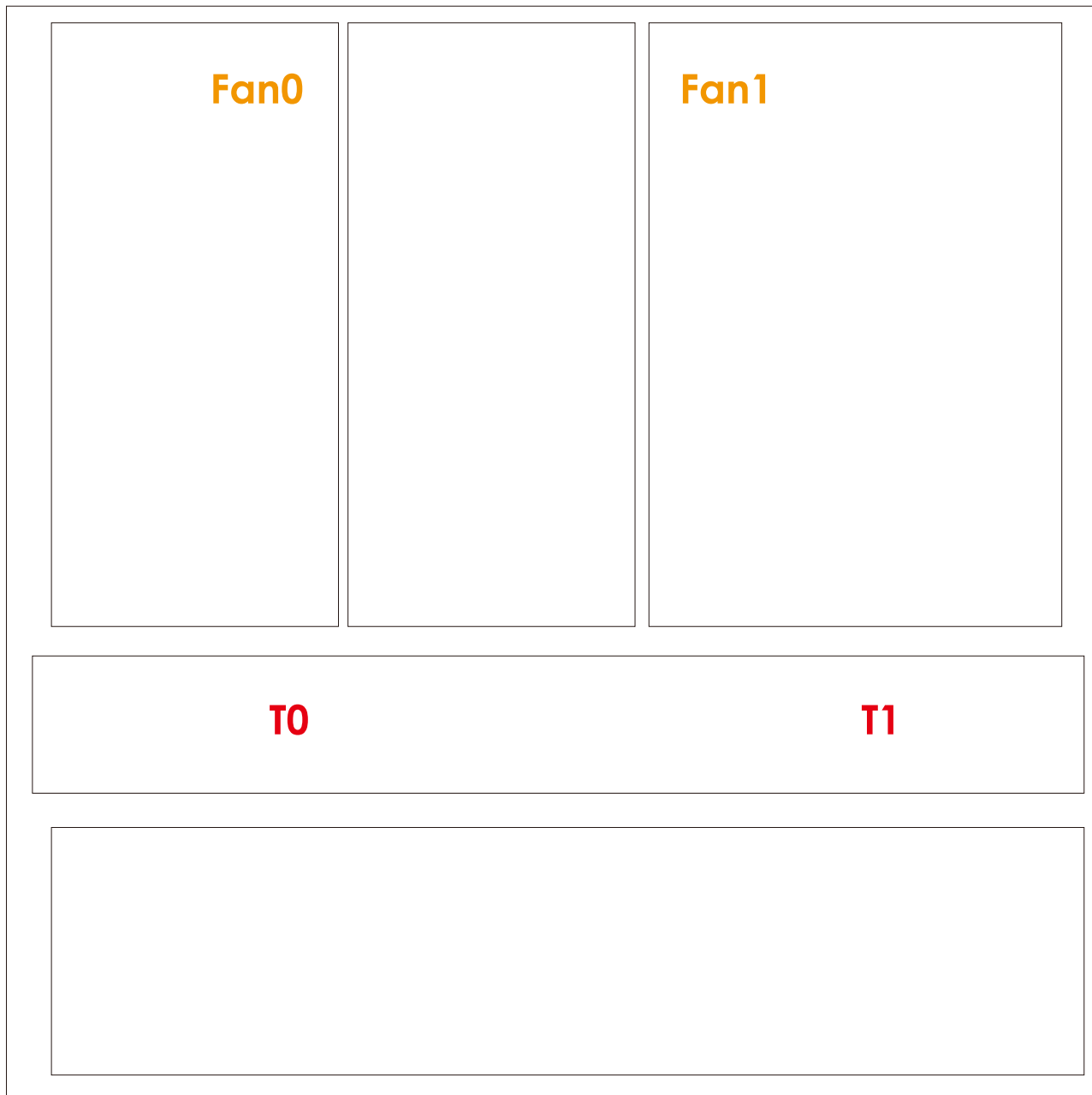

FRONT

4.2 Utility setup on Host

Please refer to Section 3.2

4.3 Connect Host to BMC by RS232

1. Type the “[” , it will show the IPMI serial interface

```
-----  
IPMI Terminal Interface  
-----
```

```
Usage :  
Terminal Text command : [SYS Command]  
Terminal IPMI command : [NetFn SeqNum Cmd Data 0 ... Data N]  
Type [SYS HELP] - To get list of Text Command  
IPMI Terminal:/> [
```

Type command for login the interface.

```
#[sys pwd -u admin admin ]
```

It will response [OK]

```
IPMI Terminal:/> [sys pwd -u admin admin ]  
[OK]
```

2. Get LAN information

Get LAN static IP /DHCP [30 00 02 01 04 00 00]
 Get LAN IP [30 00 02 01 03 00 00]
 Get submask [30 00 02 01 06 00 00]
 Get gateway [30 00 02 01 0C 00 00]

0 _{hex}	=	0 _{dec}
1 _{hex}	=	1 _{dec}
2 _{hex}	=	2 _{dec}
3 _{hex}	=	3 _{dec}
4 _{hex}	=	4 _{dec}
5 _{hex}	=	5 _{dec}
6 _{hex}	=	6 _{dec}
7 _{hex}	=	7 _{dec}
8 _{hex}	=	8 _{dec}
9 _{hex}	=	9 _{dec}
A _{hex}	=	10 _{dec}
B _{hex}	=	11 _{dec}
C _{hex}	=	12 _{dec}
D _{hex}	=	13 _{dec}
E _{hex}	=	14 _{dec}
F _{hex}	=	15 _{dec}

```
IPMI Terminal:/> [30 00 02 01 04 00 00 ]
[34 00 02 00 11 02]
```

```
IPMI Terminal:/> [30 00 02 01 03 00 00 ]
[34 00 02 00 11 C0 A8 58 6B]
```

```
IPMI Terminal:/> [30 00 02 01 06 00 00 ]
[34 00 02 00 11 FF FF FF 00]
```

```
IPMI Terminal:/> [30 00 02 01 0C 00 00 ]
[34 00 02 00 11 C0 A8 58 01]
```

Get LAN static IP /DHCP: **01 is static IP, 02 is DHCP.**

The red box is hexadecimal, according to the left picture, the IP is $16 \times 12 + 0 = 192$, $16 \times 10 + 8 = 168$, $16 \times 5 + 8 = 88$, $16 \times 6 + 11 = 107$, It is **192.168.88.107**

3. Set LAN information

Set LAN information

Set LAN static IP /DHCP [30 00 01 01 04 01/02]
Set LAN IP [30 00 01 01 03 C0 A8 00 0A]
Set submask [30 00 01 01 06 FF FF FF 00]
Set gateway [30 00 01 01 0C C0 A8 00 01]

```
IPMI Terminal:/> [30 00 01 01 04 01 ]  
[34 00 01 00]  
IPMI Terminal:/> [30 00 01 01 03 C0 A8 00 0A ]  
[34 00 01 00]  
IPMI Terminal:/> [30 00 01 01 06 FF FF FF 00 ]  
[34 00 01 00]  
IPMI Terminal:/> [30 00 01 01 0C C0 A8 00 01 ]  
[34 00 01 00]
```

The Green returns text that in red box is completion code, **00 means OK**,
The blue text can change the value what you want, if you want to change
the IP address, must **set the LAN status to static**.

Chapter 4 BMC Configuration and Setting

4. Login the web page

Open a browser, type the IP in the address bar

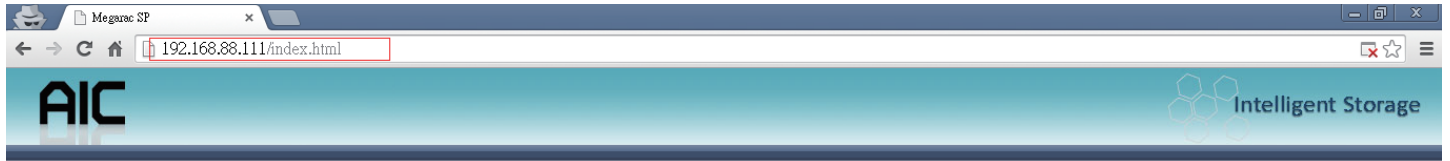

Username:

Password: [Forgot Password?](#)

Required Browser Settings

1. Allow popups from this site
2. Allow file download from this site. (How to )
3. Enable javascript for this site
4. Enable cookies for this site

It is recommended not to use Refresh, Back and Forward options of the browser.

Type the default account and password

Account:admin

Password:admin

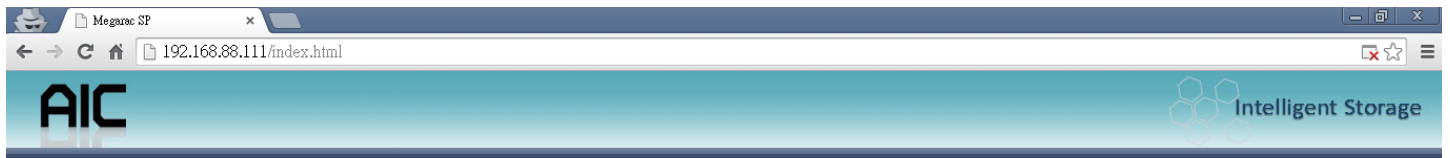

Username:

Password: [Forgot Password?](#)

Required Browser Settings

1. Allow popups from this site
2. Allow file download from this site. (How to )
3. Enable javascript for this site
4. Enable cookies for this site

It is recommended not to use Refresh, Back and Forward options of the browser.

4.4 Web UI

4.4.1 Dashboard

Device Information

Displays the Firmware Revision and Firmware Build Time (Date and Time).

Network Information

Shows network settings for the device. Click on the link Edit to view the Network Settings Page.

Remote Control

Not support this function.

Remote Console Preview Box

It will show the console preview of the remote server using java application. Click on 'Refresh' button to reload the console preview.

Sensor Monitoring

It lists all available sensors on the device, with information such as status, name, reading, and status icon, as well as a link to that sensor's page.

There are 3 possible states for a Sensor:

- Green dot denotes a Normal state.
- Yellow exclamation mark denotes a Warning state.
- Red x denotes a Critical state.

The magnifying glass allows access to the Sensor details page for that sensor.

Event Logs

A graphical representation of all events incurred by the various sensors and % occupied/available space in logs. If you click on the color-coded rectangle in the Legend for the chart, you can view a list of those specific events only.

Dashboard

Dashboard gives the overall information about the status of the device and remote server.

Device Information

Firmware Revision: 1.2.0
Firmware Build Time: Nov 27 2014 14:30:44 CST

Network Information (Edit)

MAC Address: 00:15:B2:A6:24:AA
V4 Network Mode: DHCP
IPv4 Address: 192.168.88.130
V6 Network Mode: Disable

Remote Control Console not supported

Sensor Monitoring

Status	Sensor	Reading	
	Fan_0	Not Available	🔍
	Fan_1	Not Available	🔍
	Temp0	Not Available	🔍
	PS1_Status	Not Available	🔍
	PS2_Status	Not Available	🔍
	PS_Watt	Not Available	🔍

Event Logs

Unknown (0.11%)
PS2_Status (0.03%)
PS1_Status (0.03%)
Free Space (99.83%)

4.4.2 FRU information

This page displays the BMC FRU file information. On selecting a particular FRU Device ID its corresponding FRU information will be displayed.

Basic Information

It displays the FRU device ID and device name for the selected FRU device ID.

Chassis Information

It displays the following Chassis information fields.

- Area Format Version
- Chassis Type
- Chassis Part Number
- Chassis Serial Number
- Chassis Extra

Board Information

It displays the following Board information fields.

- Area Format Version
- Language
- Manufacture Date Time
- Board Manufacturer
- Board Product Name
- Board Serial Number

- Board Part Number
- FRU File ID
- Board Extra

Product Information

It displays the following Product information fields.

- Area Format Version
- Language
- Manufacturer Name
- Product Name
- Product Part Number
- Product Version
- Product Serial Number
- Asset Tag
- FRU File ID
- Product Extra

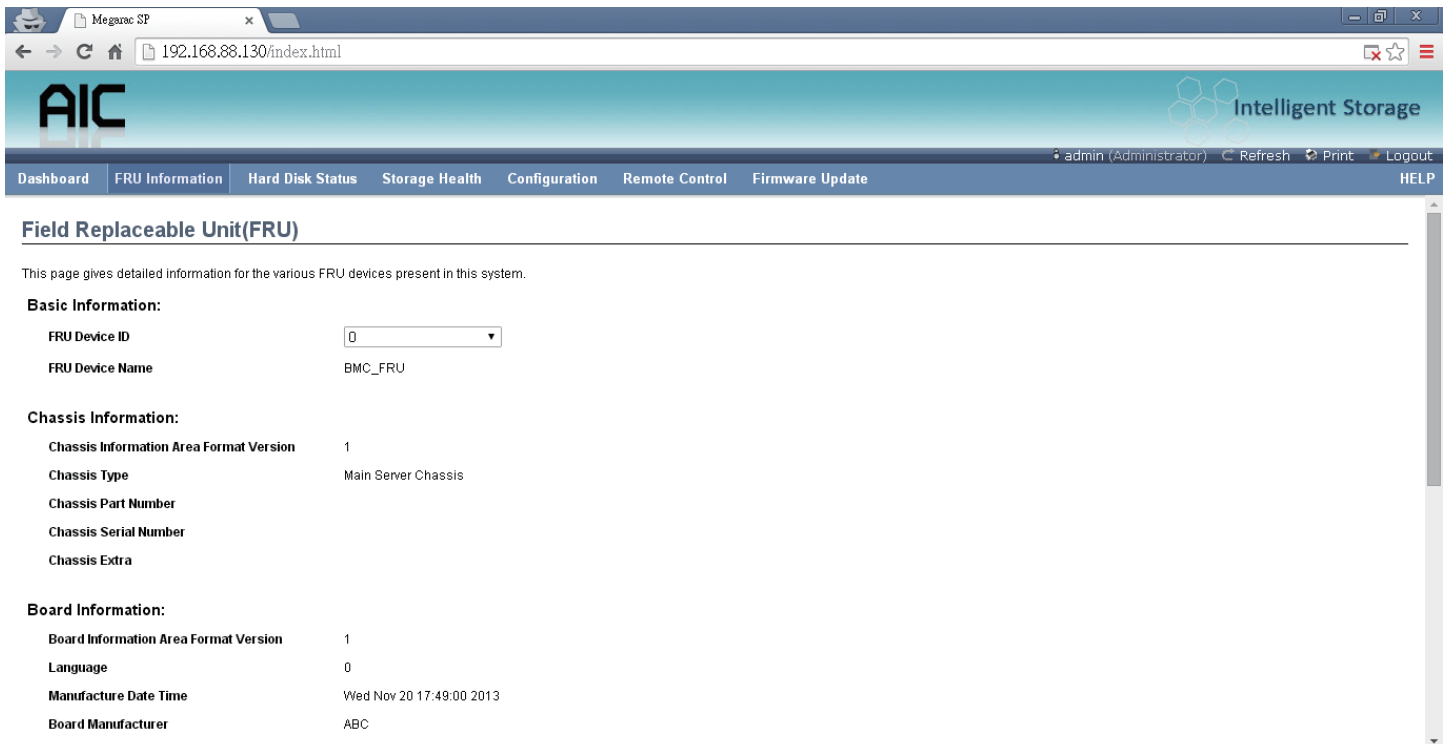

4.4.3 Hard Disk Status

This page displays all the HDD power on/off status, using the "Power On" and "Power Off" button to control HDD status.

ACTIONS

Power On

Select a HDD to turn it power on.

Power off

Select a HDD to turn it power off.

NOTE :

WHEN SELECT A HDD TO POWER ON/OFF, MUST TO REFRESH THIS PAGE FOR GET THE NEW STATUS.

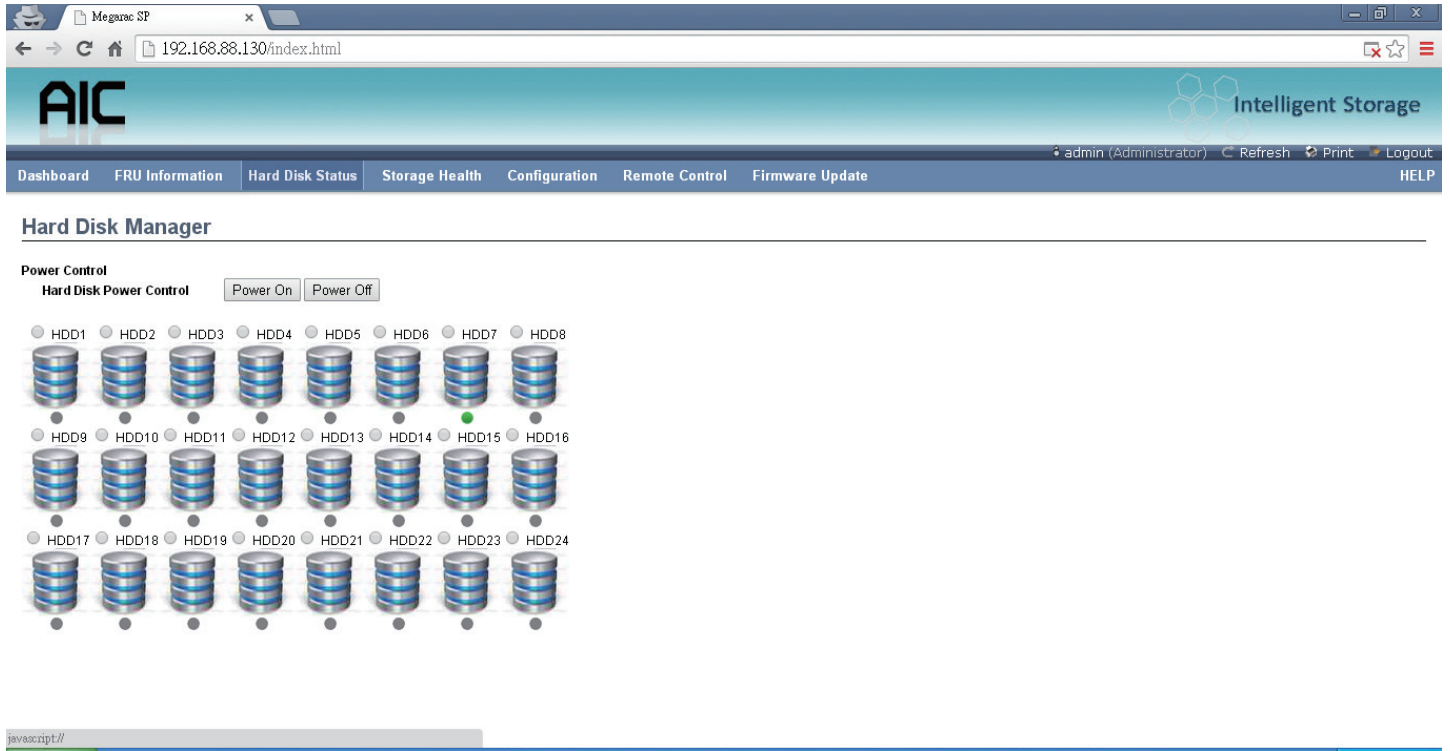

4.4.4 Storage Health

4.4.4.1 Sensor Readings

A list of sensor readings will be displayed here. Click on a record to show more information about that particular sensor, including thresholds and a graphical representation of all associated events. Double click on a record to toggle (ON / OFF) the live widget for that particular sensor. You can filter the list to view particular sensors only using the drop-down list box.

NOTE :
N/A REPRESENTS NOT APPLICABLE.

Live Widget

Turn On or Off the live widget for this sensor. This widget gives a dynamic representation of the readings for the sensor.

View this Event Log

Click this button to go the event log page for the viewed sensor.

The screenshot shows a web browser window displaying the BMC interface. The page title is 'Sensor Readings'. A navigation menu includes 'Dashboard', 'FRU Information', 'Hard Disk Status', 'Storage Health', 'Configuration', 'Remote Control', and 'Firmware Update'. The 'Storage Health' section is active. Below the navigation, there is a dropdown menu for 'All Sensors' and a 'Sensor Count: 6 sensors' indicator. A table lists sensor data:

Sensor Name	Status	Current Reading
Fan_0	Normal	5400 RPM
Fan_1	Normal	5400 RPM
Temp0	Normal	28 °C
PS1_Status	Presence Detected	0x8001
PS2_Status	Presence Detected	0x8001
PS_Watt	Normal	42 Watts

Below the table, the details for 'Fan_0: 5400 RPM' are shown. The status is 'NORMAL'. A 'LiveWidget' toggle is set to 'OFF'. The 'Thresholds for this sensor' are:

- Lower Non-Recoverable (LNR): 2400 RPM
- Lower Critical (LC): 3200 RPM
- Lower Non-Critical (LNC): 0 RPM
- Upper Non-Recoverable (UNR): 0 RPM
- Upper Critical (UC): 0 RPM
- Upper Non-Critical (UNC): 0 RPM

A 'Threshold Settings' button is located below the thresholds. The 'Graphical View of this sensor's events' section shows a table with columns for LNR, LC, LNC, UNR, and UC, each with a count of (0).

4.4.4.2 Event Log

This page displays the list of events incurred by different sensors on this device. Double click on a record to see the details of that entry. You can also sort the list of entries by clicking on any of the column headers. You can use the sensor type or sensor name filter options to view those specific events logged in the device.

BMC Timezone

Check this option to display the event log entries logged with the BMC Timezone value.

Client Timezone

Check this option to display the event log entries logged with the Client (user's) Timezone value.

UTC Offset

Displays the current UTC Offset value based on which event Time Stamps will be updated. Navigational arrows can be used to selectively access different pages of the Event Log.

Clear All Event Logs

Clear All Event Logs option will delete all existing records for all sensors.

Save All Event Logs

Save All Event Logs option will save all existing records for all sensors.

Events generated by the system will be logged here. Double-click on a record to see the description.

All Events filter by: All Sensors Event Log: 7 event entries, 1 page(s)

BMC Timezone Client Timezone UTC Offset: (GMT+/-0)

Event ID	Time Stamp	Sensor Name	Sensor Type	Description
7	11/28/2014 08:20:19	#0xa0	OEM	Transition to Running - Asserted
6	11/28/2014 04:02:01	#0xa0	OEM	Transition to Power Off - Asserted
5	11/27/2014 06:51:17	#0xa0	OEM	Transition to Running - Asserted
4	11/27/2014 06:51:16	#0xa0	OEM	Transition to Power Off - Asserted
3	11/27/2014 06:48:18	PS2_Status	Power Supply	Presence Detected - Asserted
2	11/27/2014 06:48:18	PS1_Status	Power Supply	Presence Detected - Asserted
1	01/01/2012 00:00:00	#0xa0	OEM	Transition to Running - Asserted

Save Event Logs Clear All Event Logs

4.4.5 Configuration

4.4.5.1 DNS

This page is used to configure the Host name and Domain Name Server configuration of the device.

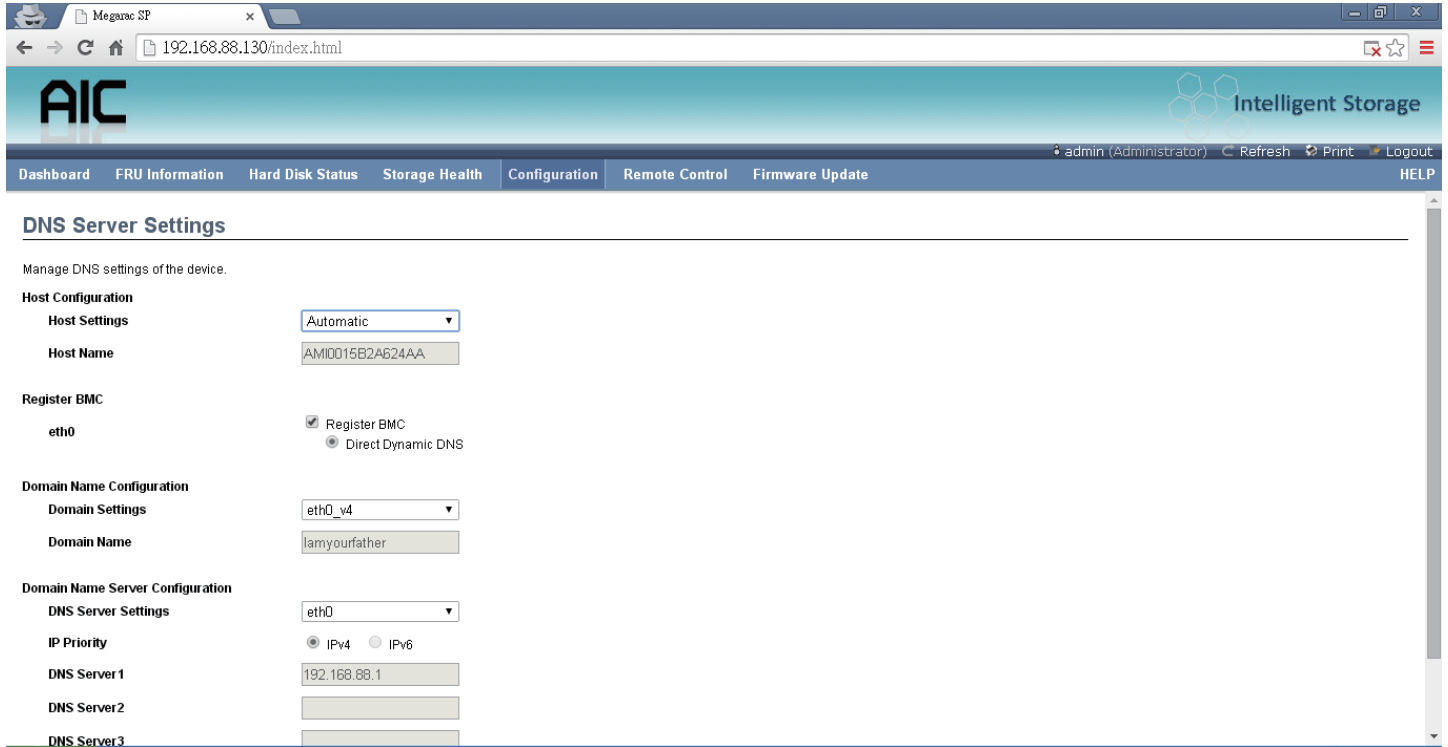

Host configuration

Host Settings Choose either Automatic or Manual settings.

Host Name It displays the hostname of the device if Auto is selected. If the Host setting is chosen as Manual, then specify the hostname of the device.

Register BMC Choose the BMC's network port to register with the DNS settings. Check the option 'Register BMC' to register with the DNS settings. Choose the option 'Direct Dynamic DNS' to register with direct dynamic DNS or choose 'DHCP Client FQDN' to register through a DHCP server.

Domain Name Configuration

Domain Settings It lists the options for the domain interface as Manual, v4 or v6 for multi LAN channels.

Domain Name It displays the domain name of the device if Auto is selected. If the Domain setting is chosen as Manual, then specify the domain name of the device.

Domain Name Server Configuration

DNS Server Settings It lists the options for the DNS interface, Manual and available LAN interfaces.

IP Priority If the IP Priority is IPv4, it will have 2 IPv4 DNS servers and 1 IPv6 DNS server. If the IP Priority is IPv6, it will have 2 IPv6 DNS servers and 1 IPv4 DNS server.

NOTE :

THIS IS NOT APPLICABLE FOR MANUAL CONFIGURATION.

DNS Server 1, 2 & 3

Specify the DNS (Domain Name System) server address to be configured for the BMC.

- An IPv4 Address is made of 4 numbers separated by dots as in "xxx.xxx.xxx.xxx".
- Each number ranges from 0 to 255.
- The first number must not be 0.

DNS Server Address will support the following:

- IPv4 Address format.
- IPv6 Address format.

Save

Click 'Save' to save any changes made. You will be logged out of current UI session and will need to log back in.

Reset

Reset the modified changes.

4.4.5.2 Network

This page is used to configure the network settings for available LAN channels.

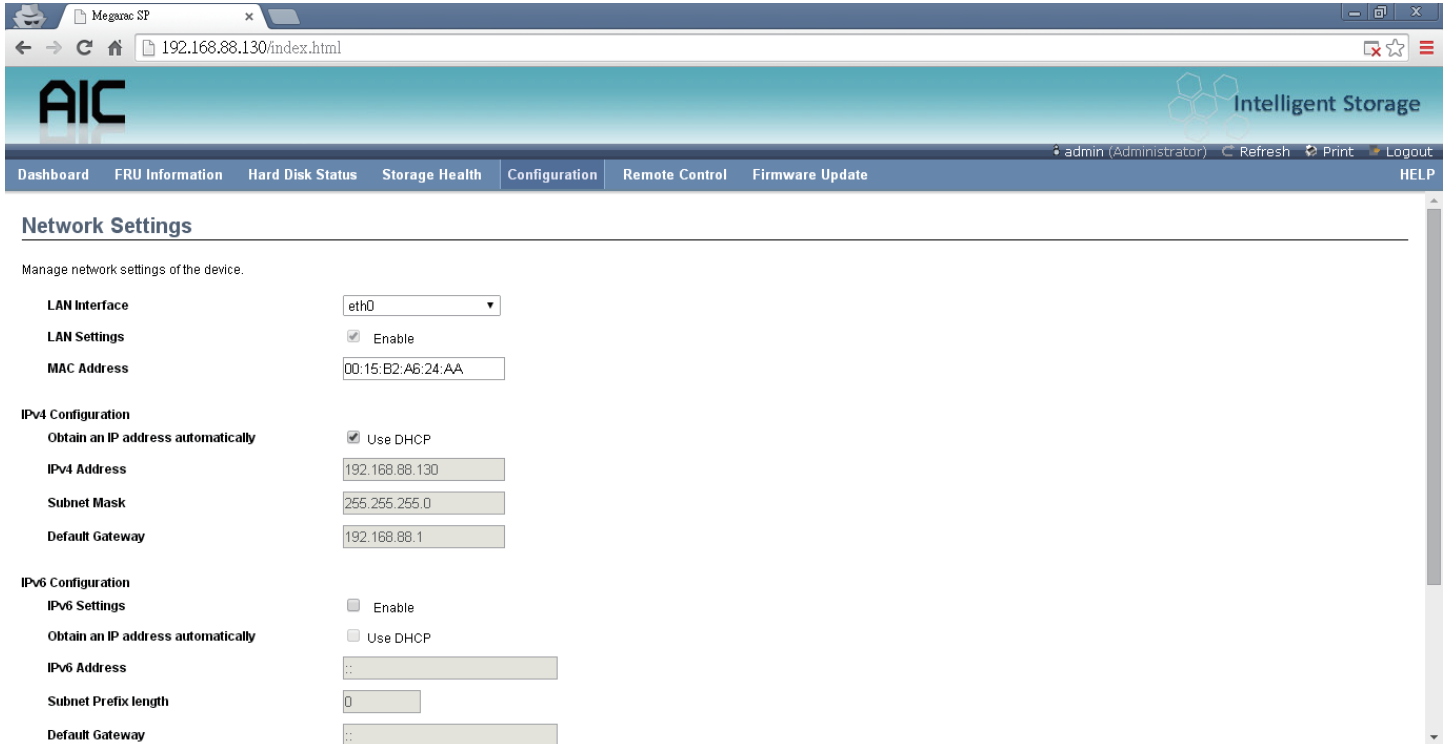

LAN Interface

Select the LAN interface to be configured.

LAN Settings

Check this option to enable LAN support for the selected interface.

MAC Address

This field displays the MAC address of the selected interface (read only).

IPv4 Configuration

It lists the IPv4 configuration settings.

Obtain an IP address automatically

Enable 'Use DHCP' to dynamically configure the IPv4 address using Dynamic Host Configuration Protocol (DHCP).

IPv4 Address, Subnet Mask, Default Gateway

If DHCP is disabled, specify a static IPv4 address, Subnet Mask and Default Gateway to be configured for the selected interface.

- An IP Address consists of 4 sets of numbers separated by dots as in "xxx.xxx.xxx.xxx".
- Each set ranges from 0 to 255.
- The first Number must not be 0.

IPv6 Configuration

It lists the IPv6 configuration settings.

IPv6 Settings

Check this option to enable IPv6 support for the selected interface.

Obtain an IP address automatically

Enable 'Use DHCP' to dynamically configure the IPv4 address using Dynamic Host Configuration Protocol (DHCP).

IPv6 Address

Specify a static IPv6 address to be configured for the selected interface.

Subnet Prefix length

Specify the subnet prefix length for the IPv6 settings.

- Value ranges from 0 to 128.

Default Gateway

Specify the v6 default gateway for IPv6 settings.

Save

Click 'Save' to save any changes made. You will be prompted to log out of the current UI session and log back in at the new IP address.

Reset

Click 'Reset' to reset the modified changes.

4.4.5.3 Network Link

This page is used to configure the network link option for the available network interfaces.



LAN Interface

Select the network interface from the list for which the Link speed and duplex mode are to be configured.

Auto Negotiation

This option is enabled to allow the device to perform automatic configuration to achieve the best possible mode of operation (speed and duplex) over a link.

Link Speed

Link speed will list all the supported capabilities of the network interface. It can be 10/100/1000 Mbps.

Duplex Mode

Select any one of the following Duplex Modes.

- Half Duplex
- Full Duplex

Save

Click 'Save' to save the settings.

Reset

Click 'Reset' to reset the modified changes.

4.4.5.4 NTP

This page displays the device's current Date & Time Settings. It can be used to configure either Date & Time or NTP (Network Time Protocol) server settings for the device.

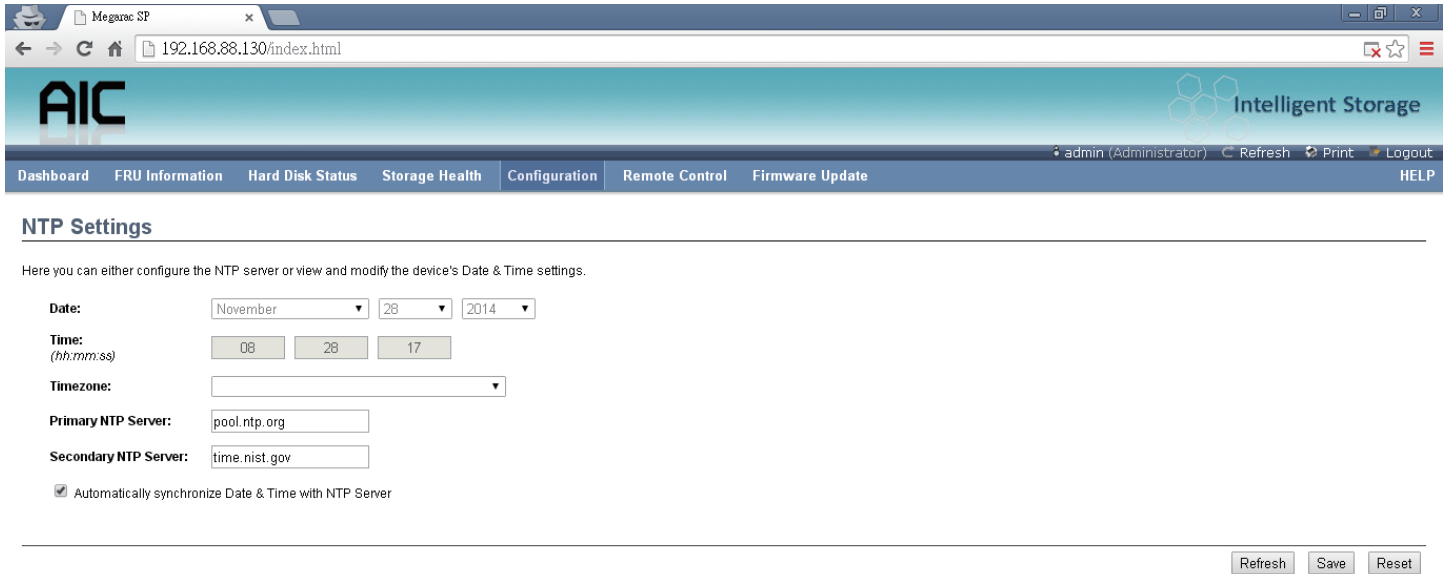

Date

Specify the current Date for the device.

Time

Specify the current Time for the device.

NOTE :

AS A YEAR 2038 PROBLEM EXISTS, THE ACCEPTABLE DATE RANGE IS FROM 01-01-2005 TO 01-18-2038.

NTP Server

Specify the NTP Server for the device. Check the 'Automatically synchronize' option to configure the NTP Server. The NTP Server will support the following:

- IP Address (Both IPv4 and IPv6 format).
- FQDN (Fully qualified domain name) format.

UTC Offset

UTC Offset list contains the UTC offset values for the NTP server, which can be used to display the exact local time.

NOTE :

**USE THE CORRECT UTC OFFSET AFTER ADJUSTING FOR DST.
AUTOMATICALLY SYNCHRONIZE**

Check this option to automatically synchronize Date and Time with the NTP Server.

Refresh

Click 'Refresh' to reload the current date & time settings.

Save

Click 'Save' to save any changes made.

Reset

Click 'Reset' to reset the modified changes.

4.4.5.5 PEF

This page is used to configure the Event Filter, Alert Policy and LAN Destination. To view the page, the user must at least be an Operator. To modify or add a PEF, the user must be an Administrator.

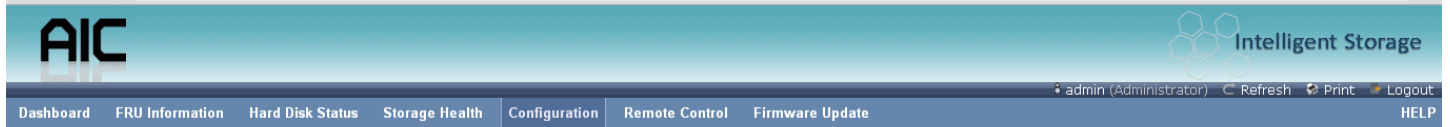

PEF Management

Use this page to configure Event Filter, Alert Policy and LAN Destination. To delete or modify a entry, select it in the list and click "Delete" or "Modify". To add a new entry, select an unconfigured slot and click "Add".

Event Filter Alert Policy LAN Destination

Configured Event Filter count: 15

PEF ID	Filter Configuration	Event Filter Action	Event Severity	Sensor Name
1	Enabled	[Alert]	Unspecified	Any
2	Enabled	[Alert]	Unspecified	Any
3	Enabled	[Alert]	Unspecified	Any
4	Enabled	[Alert]	Unspecified	Any
5	Enabled	[Alert]	Unspecified	Any
6	Enabled	[Alert]	Unspecified	Any
7	Enabled	[Alert]	Unspecified	Any
8	Enabled	[Alert]	Unspecified	Any
9	Enabled	[Alert]	Unspecified	Any
10	Enabled	[Alert]	Unspecified	Any
11	Enabled	[Alert]	Unspecified	Any
12	Enabled	[Alert]	Unspecified	Any
13	Enabled	[Alert]	Unspecified	Any

NOTE :

FREE SLOTS ARE DENOTED BY '~' IN ALL COLUMNS FOR THE SLOT. FOR MORE INFORMATION, REFER THE PLATFORM EVENT FILTERING (PEF) SECTION IN IPMI SPECIFICATION.

Event Filter

Click the Event Filter tab to show configured Event filters and available slots. You can modify or add new event filter entries here. A maximum of 40 slots are available and include the default of 15 event filter configurations.

Alert Policy

Click the Alert policy tab to show configured Alert policies and available slots. You can modify or add new alert policy entries here. A maximum of 60 slots are available.

LAN Destination

Click the LAN Destination tab to show configured LAN destinations and available slots. You can modify or add new LAN destination entries here. A maximum of 15 slots are available

Send Test Alert

Select a configured slot in the LAN Destination tab and click 'Send Test Alert' to send a sample alert to the configured destination.

NOTE :

TEST ALERTS CAN BE SENT ONLY WITH SMTP CONFIGURATIONS SET TO ENABLED. SMTP SUPPORT CAN BE ENABLED UNDER CONFIGURATION->SMTP.

Add

Select a free slot and click 'Add' to add a new entry to the device. Alternatively, double click on a free slot.

Modify

Select a configured slot and click 'Modify' to modify that entry. Alternatively, double click on the configured slot.

Delete

Select the desired configured slot to be deleted and click 'Delete'.

4.4.5.6 SMTP

This page is used to configure the SMTP settings.

The screenshot shows the 'SMTP Settings' page in the AIC Intelligent Storage web interface. The page is titled 'SMTP Settings' and contains the following sections:

- LAN Channel Number:** A dropdown menu with '1' selected.
- Sender Address:** A text input field.
- Machine Name:** A text input field.
- Primary SMTP Server:**
 - SMTP Support:** A checked checkbox labeled 'Enable'.
 - Server Address:** A text input field.
 - SMTP Server requires Authentication:** An unchecked checkbox.
 - User Name:** A text input field.
 - Password:** A text input field.
- Secondary SMTP Server:**
 - SMTP Support:** An unchecked checkbox labeled 'Enable'.
 - Server Address:** A text input field.
 - SMTP Server requires Authentication:** An unchecked checkbox.
 - User Name:** A text input field.

LAN Channel Number

Select the LAN channel to which the SMTP information needs to be configured.

Sender Address

Enter the 'Sender Address' valid on the SMTP Server.

Machine Name

Enter the 'Machine Name' of the SMTP Server.

- Machine Name is a string of maximum 15 alpha-numeric characters.
- Space, special characters are not allowed.

Primary SMTP Server

It lists the Primary SMTP Server configuration.

SMTP Support

Check this option to enable SMTP support for the BMC.

Server Address

Enter the 'IP address' of the SMTP Server. It is a mandatory field.

- An IP Address is made of 4 numbers separated by dots as in "xxx.xxx.xxx.xxx".
- Each Number ranges from 0 to 255.
- The first Number must not be 0.

The server address will support the following:

- IPv4 Address format.
- IPv6 Address format.

SMTP Server requires Authentication

Check the option 'Enable' to enable SMTP Authentication.

NOTE :

SMTP SERVER AUTHENTICATION TYPES SUPPORTED ARE:

- CRAM-MD5
- LOGIN
- PLAIN

IF THE SMTP SERVER DOES NOT SUPPORT ANY ONE OF THE ABOVE AUTHENTICATION TYPES, THE USER WILL GET AN ERROR MESSAGE STATING, "AUTHENTICATION TYPE IS NOT SUPPORTED BY SMTP SERVER"

Username

Enter the username to access SMTP Accounts.

- The User Name can be 4 to 64 alpha-numeric characters.
- It must start with an alphabet.
- Special characters ',' (comma), ':' (colon), ';' (semicolon), ' ' (space) and '\' (backslash) are not allowed.

Password

Enter the password for the SMTP User Account.

- Passwords must be at least 4 characters long.
- Space is not allowed.

NOTE :

THIS FIELD WILL NOT ALLOW MORE THAN 64 CHARACTERS.

Secondary SMTP Server

It lists the Secondary SMTP Server configuration. It is an optional field. If the Primary SMTP server is not working, then it tries the Secondary SMTP Server configuration.

Save

Click 'Save' to save the new SMTP server configuration.

Reset

Click 'Reset' to reset the modified changes.

4.4.5.7 User

The displayed table shows any configured Users and available slots. You can modify or add new users from here. A maximum of 10 slots are available, including the default admin and anonymous. It is advised that the anonymous user's privilege and password should be modified as a security measure. To view the page, you must have Operator privileges. To modify or add a user, You must have Administrator privileges.

NOTE :

FREE SLOTS ARE DENOTED BY “~” IN ALL COLUMNS FOR THE SLOT.

Add User

Select a free slot and click 'Add User' to add a new user to the device. Alternatively, double click on a free slot to add a user.

Modify User

Select a configured slot and click 'Modify User' to modify that user. Alternatively, double click on the configured slot.

Delete User

Select the desired user to be deleted and click 'Delete User'

The screenshot shows the 'User Management' page in the Megarac SP web interface. The page title is 'User Management' and it includes a navigation menu with options like 'Dashboard', 'FRU Information', 'Hard Disk Status', 'Storage Health', 'Configuration', 'Remote Control', and 'Firmware Update'. The main content area displays a table of users with columns for 'UserID', 'Username', 'User Access', 'Network Privilege', and 'Email ID'. Below the table are three buttons: 'Add User', 'Modify User', and 'Delete User'.

UserID	Username	User Access	Network Privilege	Email ID
1	anonymous	Disabled	Administrator	~
2	admin	Enabled	Administrator	~
3	~	~	~	~
4	~	~	~	~
5	~	~	~	~
6	~	~	~	~
7	~	~	~	~
8	~	~	~	~
9	~	~	~	~
10	~	~	~	~

4.4.6 Remote Control

4.4.6.1 Storage power control

This page helps you to view or perform any host power cycle operations.

Reset Expander

Select this option to reboot the expander without powering off (warm boot).

Power Off Storage

Select this option to immediately power off the storage.

Power On Storage

Select this option to power on the storage.

Power Cycle Storage

Select this option to first power off, and then reboot the system (cold boot).

Perform Action

Click 'Perform Action' to perform the selected option.

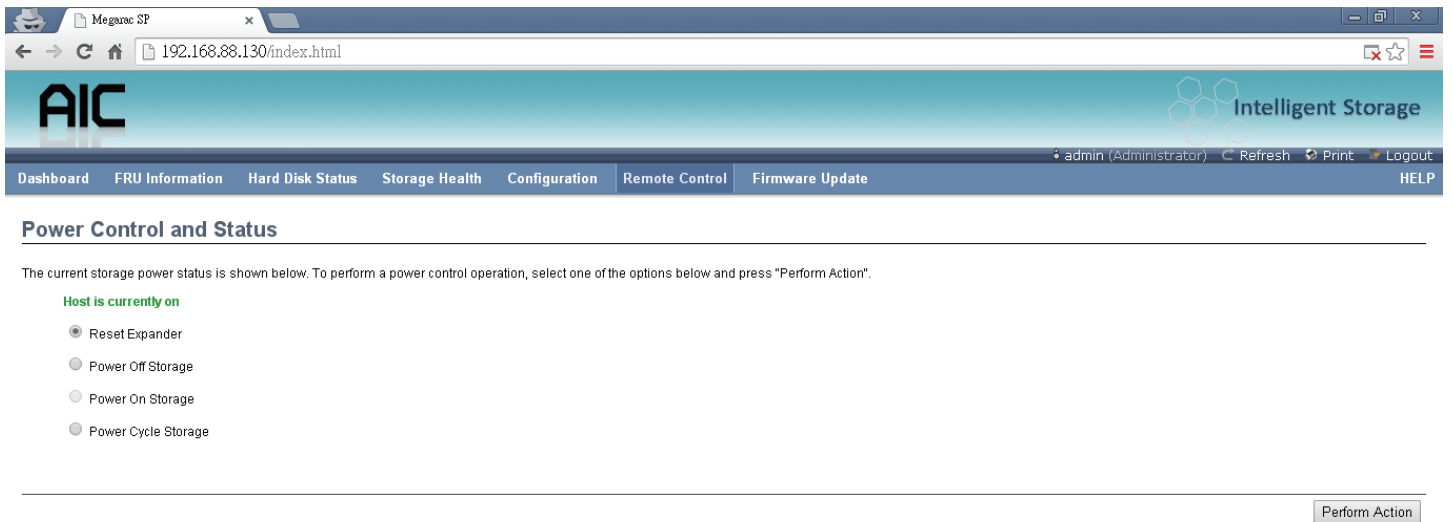

4.4.6.2 JAVA SOL

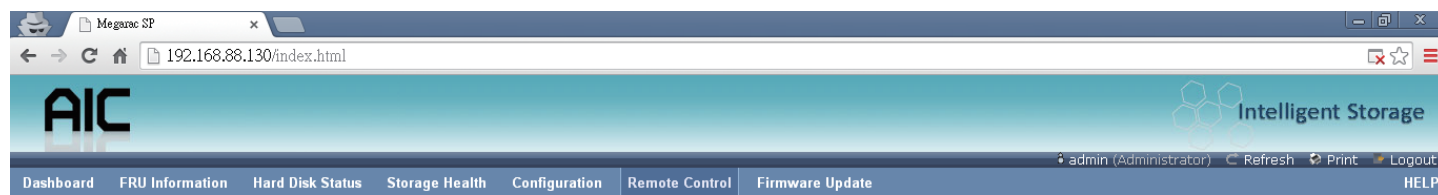

Java SOL

Press the button to launch the Java SOL.

Java SOL

Launch the Java SOL, you must have Administrator privileges.

NOTE :

A COMPATIBLE JRE MUST BE INSTALLED IN THE SYSTEM PRIOR TO THE LAUNCH OF THE JNLP FILE.

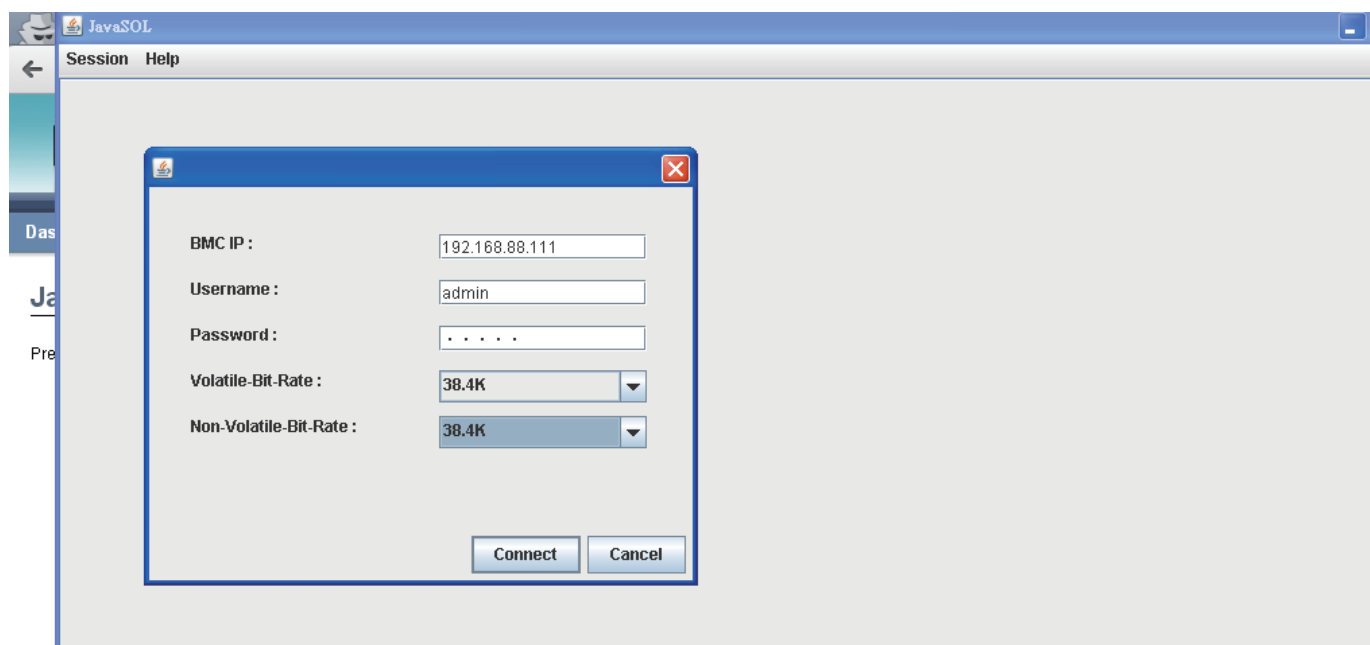

Volatile-Bit-Rate

Please set 38.4K

Non-Volatile-Bit-Rate

Please set 38.4K

This function can connect to expander command line mode.

4.5 Firmware Update

4.5.1 Requirement

Browsers:

- FireFox 24.0 or later version
- Chrome 35.0 or later version
- I.E. 7.0 or later version

Linux:

- Redhat 6.4

NOTE :

IF YOU WANT TO UPDATE A NEW VERSION FIRMWARE FOR BMC, WHEN FINISHED ALL THE UPDATE PROCESS, PLEASE CLEAR THE WEB BROWSER COOKIES.

4.5.2 Web update

1. Check the BMC IP is valid.
2. Open a browser, type in the BMC IP, it will show the BMC web UI, type the default account, or have administrator privileges account.

Username: **admin**

Password: **admin**

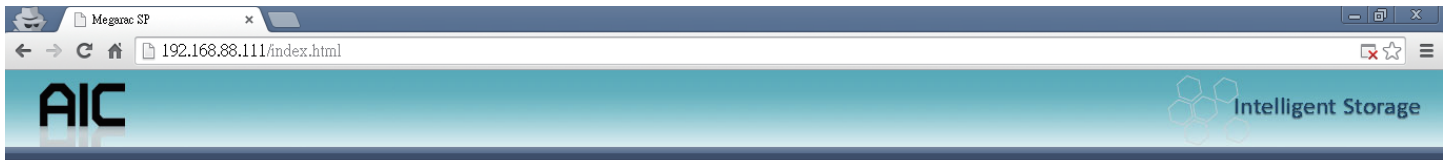

Username:

Password:
[Forgot Password?](#)

Required Browser Settings

1. Allow popups from this site
2. Allow file download from this site. (How to )
3. Enable javascript for this site
4. Enable cookies for this site

It is recommended not to use Refresh, Back and Forward options of the browser.

Chapter 4 BMC Configuration and Setting

3. This is login main page.

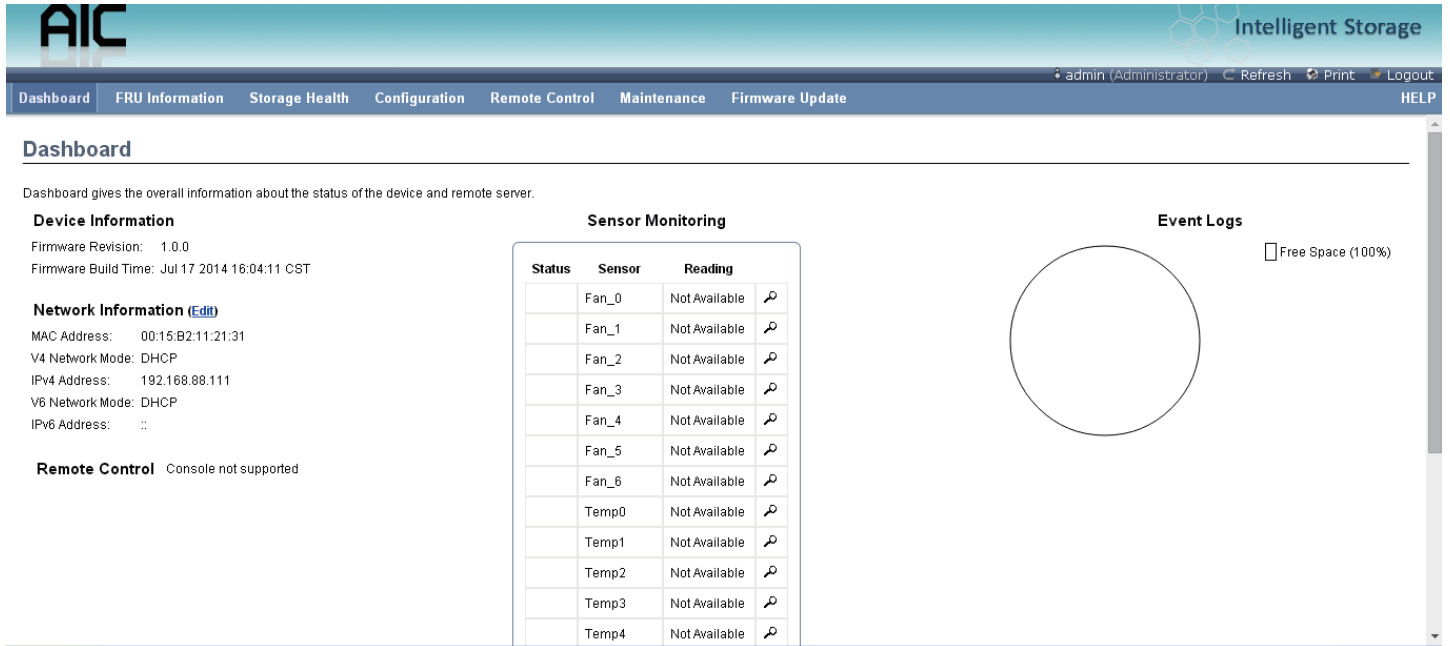

4. Click the "Firmware Update", it will pop a drop-down menu, click the "Firmware Update"

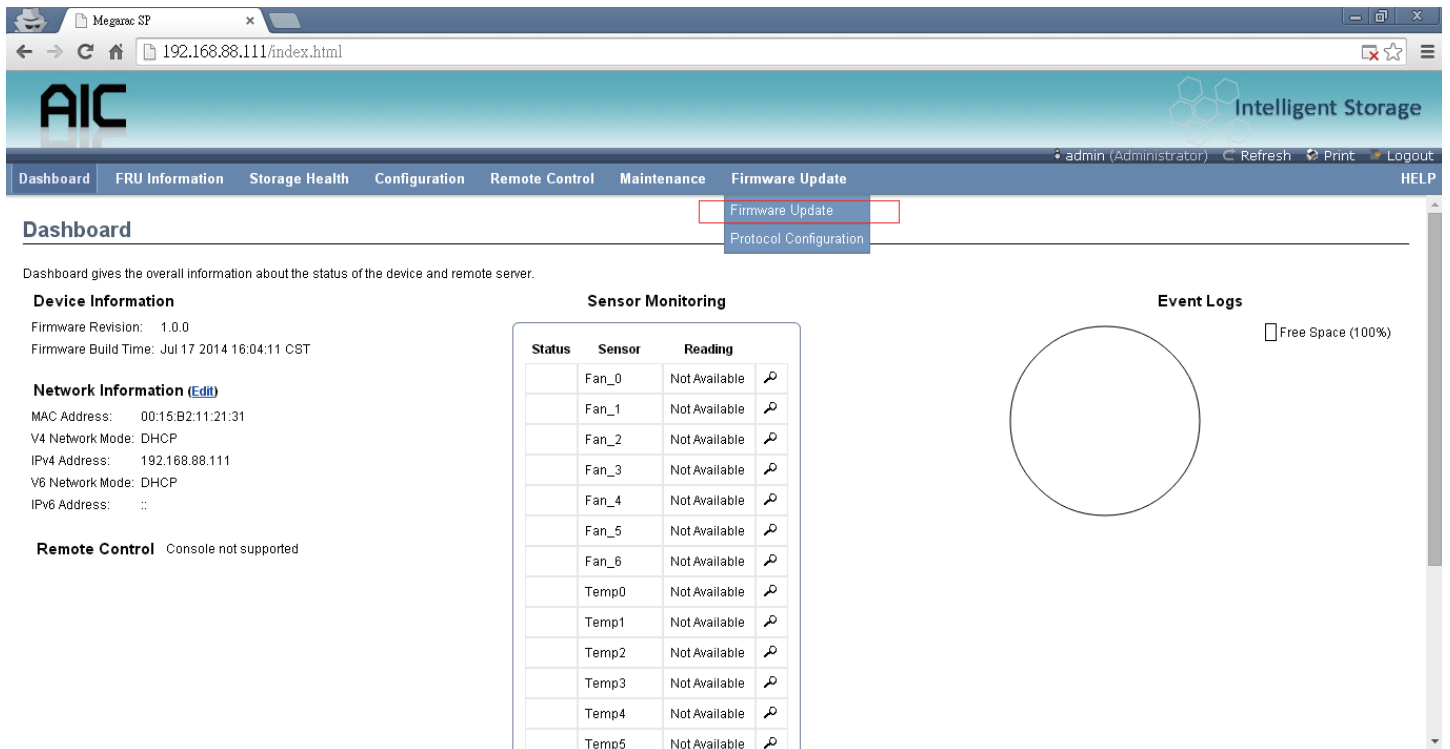

5. This page will show the update warning, if you really want to update BMC firmware, click the “Enter Update Mode” button.

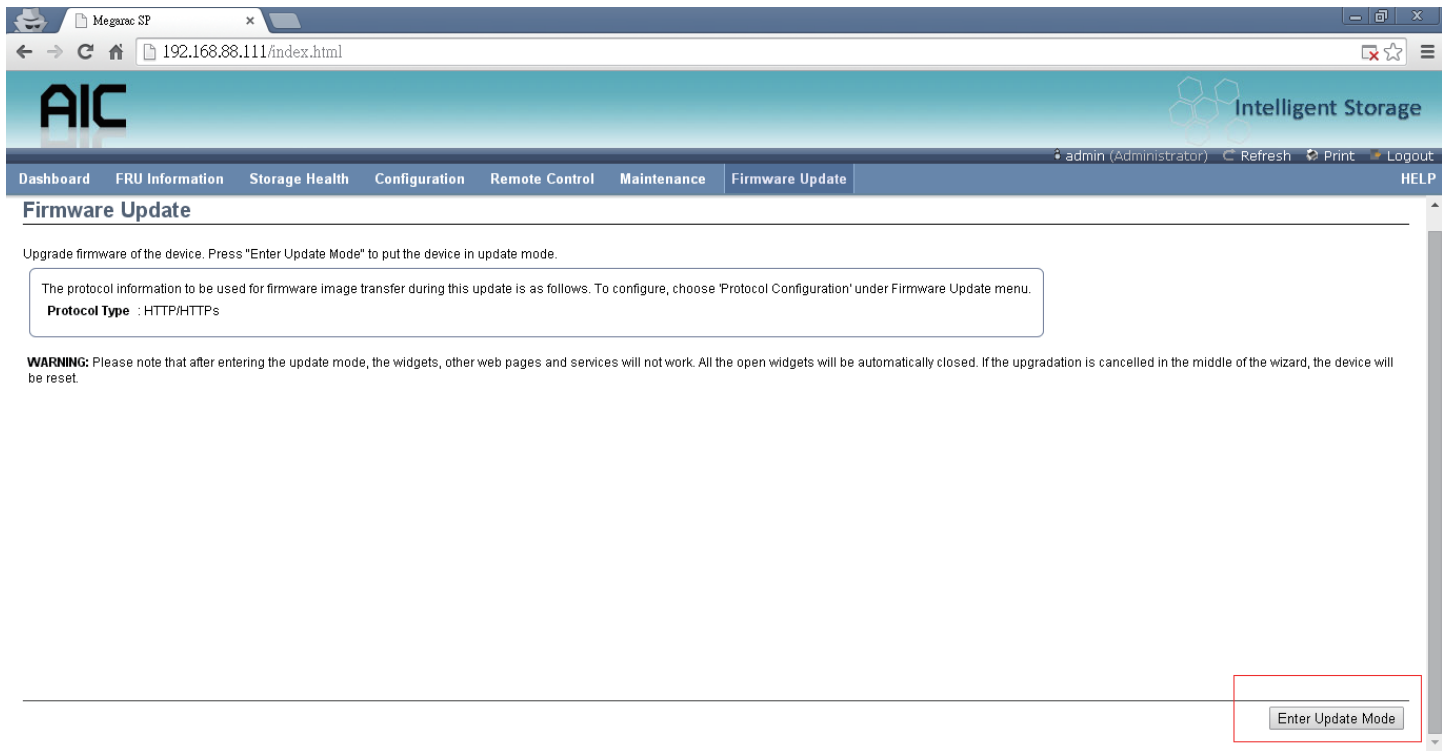

6. Wait few minutes, it will pop a window, click the “Select file” to upload firmware file that you want update.

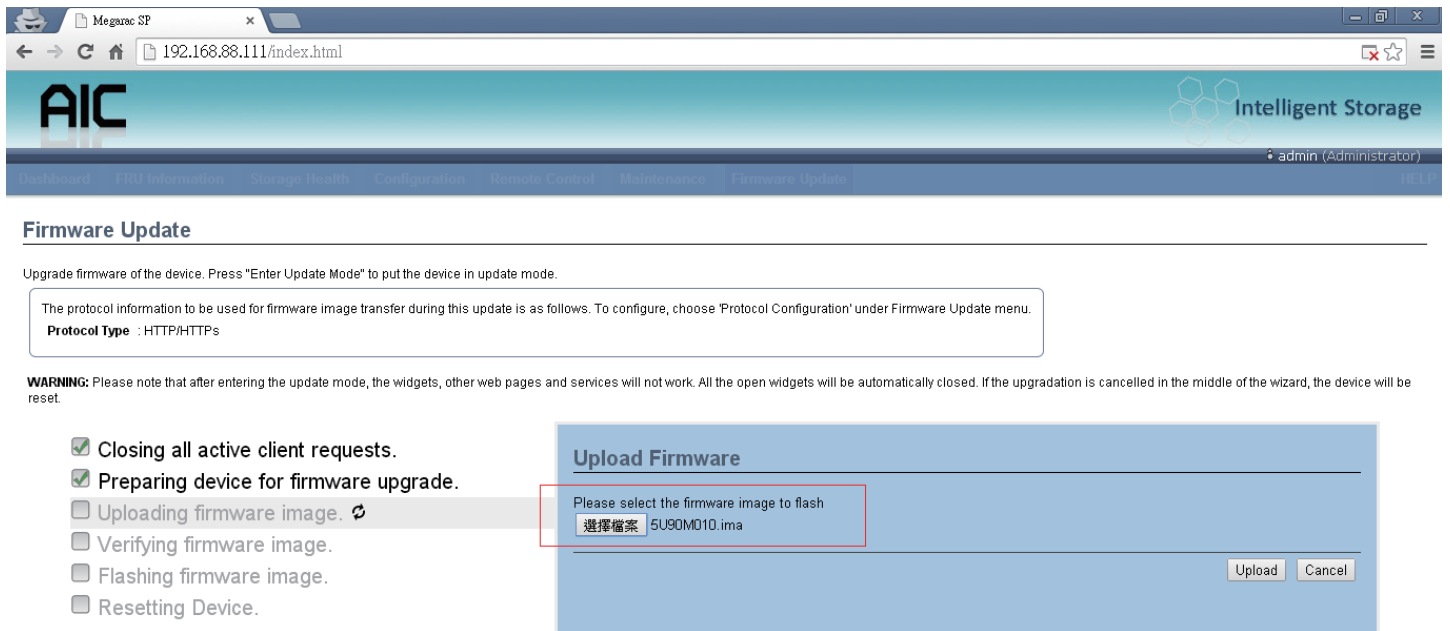

7. Wait a minutes, it will pop a window for check update section, just check the “Check this option to do all full firmware flash” option.

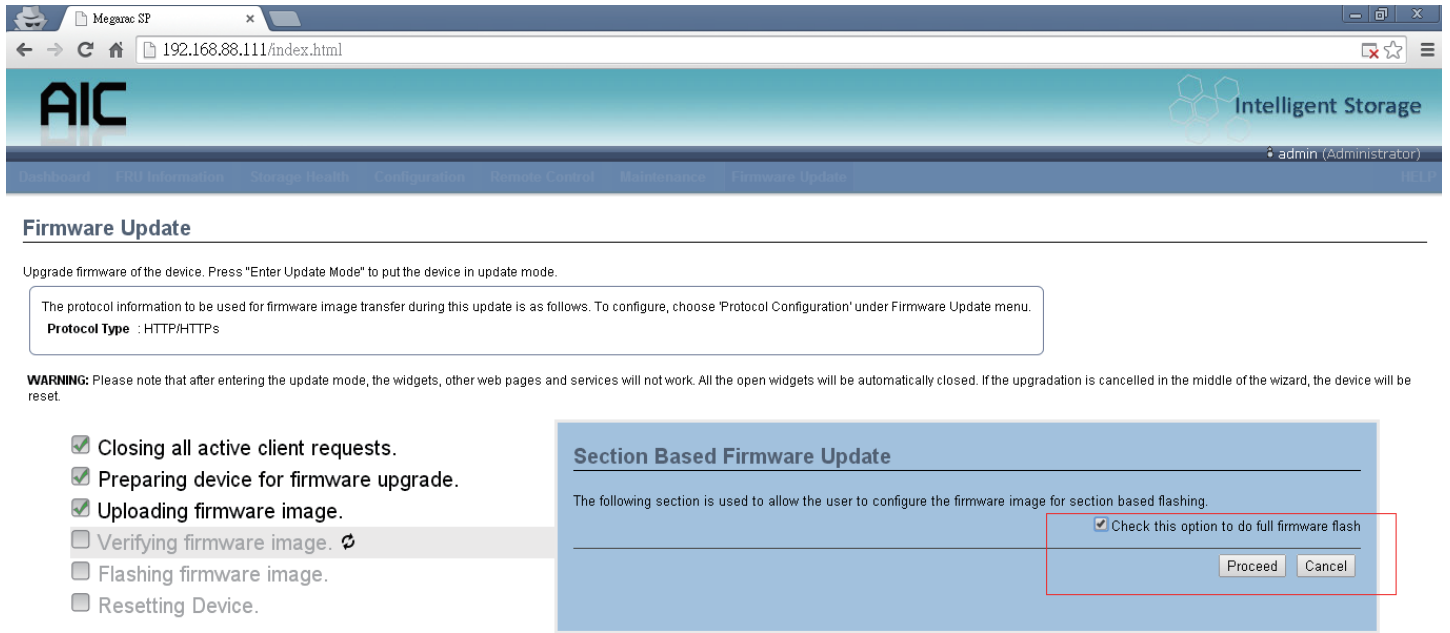

8. Click “OK” the firmware will started update operation.

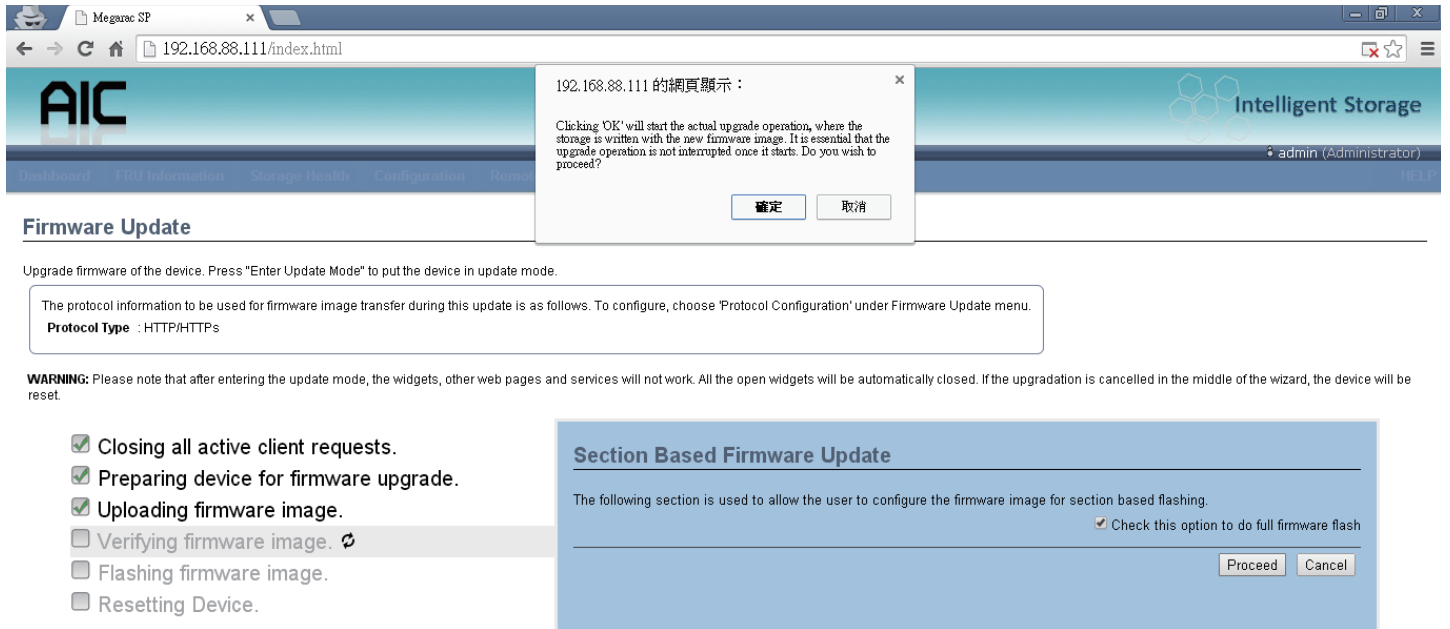

9. In the update processes, it will take 3~5 minutes.

CAUTION:

PLEASE DO NOT CLOSE THIS WEBPAGE!! OR IT WILL LET THE FIRMWARE DEATH

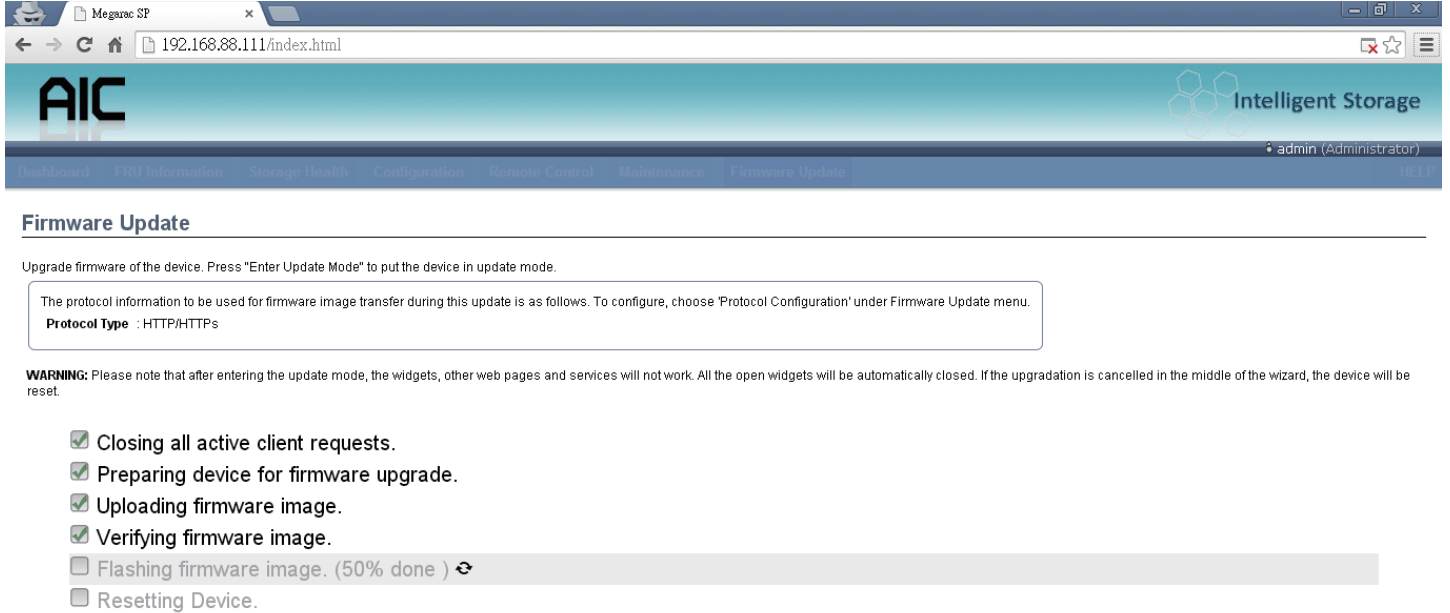

10. When show the "Device has been reset" window, it means firmware update successful, wait 90 seconds for BMC restarted.

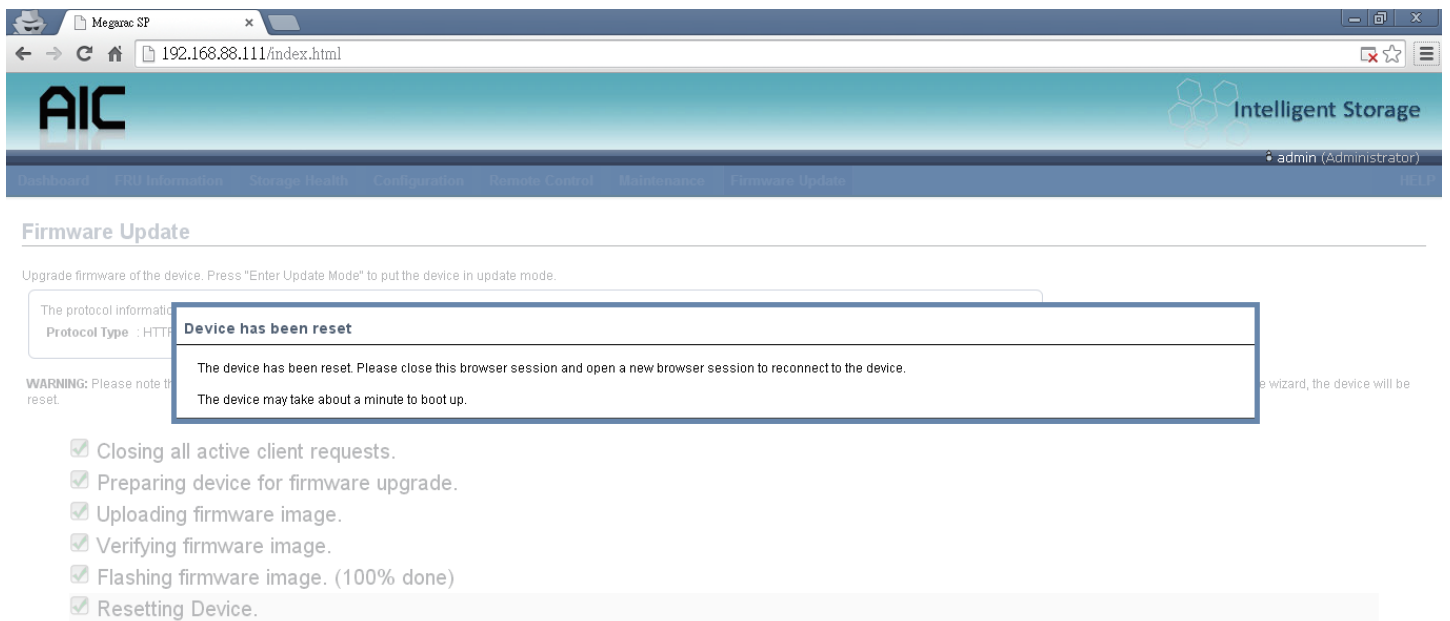

4.6 Expander firmware update

1. Click the “Firmware Update”, it will pop a drop-down menu, click the “Expand Update”

The screenshot shows the AIC Intelligent Storage web interface. The top navigation bar includes 'Dashboard', 'FRU Information', 'Hard Disk Status', 'Storage Health', 'Configuration', 'Remote Control', and 'Firmware Update'. The 'Firmware Update' menu is open, showing options for 'Firmware Update', 'Expand Update', and 'Protocol Configuration'. The main content area is divided into three sections: 'Dashboard' (overview), 'Sensor Monitoring' (table of sensors), and 'Event Logs' (circular gauge).

Status	Sensor	Reading	
	Fan_0	Not Available	🔗
	Fan_1	Not Available	🔗
	Temp0	Not Available	🔗
	PS1_Status	Not Available	🔗
	PS2_Status	Not Available	🔗
	PS_Watt	Not Available	🔗
	PSU1_temp	Not Available	🔗
	PSU2_temp	Not Available	🔗
●	Watchdog1	0x8001	🔗

2. Chose the expander firmware file then click the “upload” button.

The screenshot shows the 'Expander Update' wizard in the AIC Intelligent Storage web interface. It includes a progress list on the left and an 'Upload Expand Image' dialog box on the right.

- Closing all active client requests.
- Preparing device for Expander upgrade.
- Uploading Expander image. 🔄
- Verifying Expander image.
- Flashing Expander image.
- Update finished.

Upload Expand Image

Please select the expander firmware file to flash

1203_hotswap.fw

3. Click the “Proceed” button.

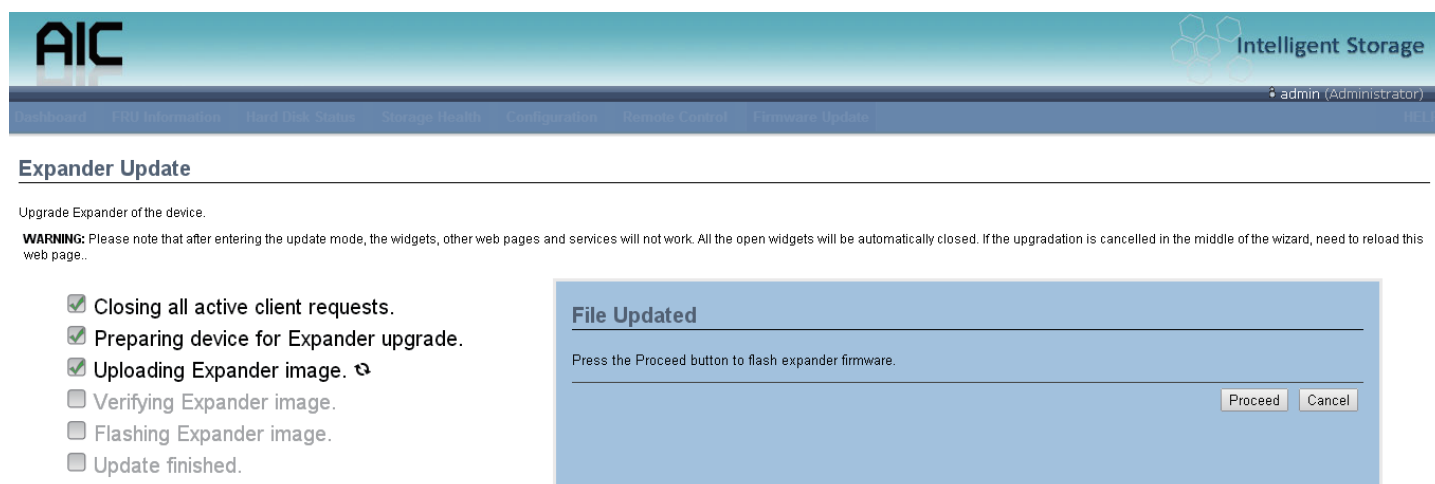

AIC Intelligent Storage

admin (Administrator) HELP

Dashboard | FRI Information | Hard Disk Status | Storage Health | Configuration | Remote Control | Firmware Update

Expander Update

Upgrade Expander of the device.

WARNING: Please note that after entering the update mode, the widgets, other web pages and services will not work. All the open widgets will be automatically closed. If the upgradation is cancelled in the middle of the wizard, need to reload this web page..

- Closing all active client requests.
- Preparing device for Expander upgrade.
- Uploading Expander image. ↻
- Verifying Expander image.
- Flashing Expander image.
- Update finished.

File Updated

Press the Proceed button to flash expander firmware.

Proceed Cancel

4. Updating

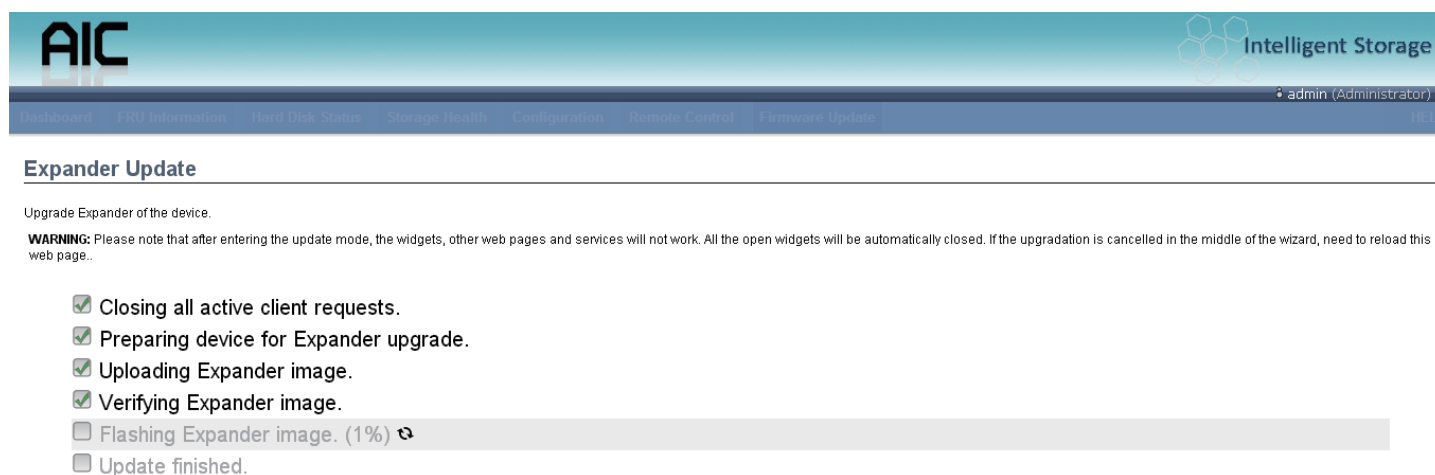

AIC Intelligent Storage

admin (Administrator) HELP

Dashboard | FRI Information | Hard Disk Status | Storage Health | Configuration | Remote Control | Firmware Update

Expander Update

Upgrade Expander of the device.

WARNING: Please note that after entering the update mode, the widgets, other web pages and services will not work. All the open widgets will be automatically closed. If the upgradation is cancelled in the middle of the wizard, need to reload this web page..

- Closing all active client requests.
- Preparing device for Expander upgrade.
- Uploading Expander image.
- Verifying Expander image.
- Flashing Expander image. (1%) ↻
- Update finished.

5. Update finished and successful.

AIC Intelligent Storage
admin (Administrator) | Dashboard | FRU Information | Hard Disk Status | Storage Health | Configuration | Remote Control | Firmware Update | HELP

Expander Update

Upgrade Expander of the device.

WARNING: Please note that after entering the update mode, the widgets, other web pages and consoles will not work. All the open widgets will be automatically closed. If the upgrade is cancelled in the middle of the wizard, need to reload this web page.

Expander has been update
The expander has been update. Please close this browser session and open a new browser session to reconnect to the device.
Do the power cycle for get new expander version

- Closing
- Preparing
- Uploading Expander image.
- Verifying Expander image.
- Flashing Expander image. (100%)
- Update finished.

6. If update processes not success, please check the expander firmware is current version or the system is already power off.

AIC Intelligent Storage
admin (Administrator) | Dashboard | FRU Information | Hard Disk Status | Storage Health | Configuration | Remote Control | Firmware Update | HELP

Expander Update

Upgrade Expander of the device.

WARNING: Please note that after entering the update mode, the widgets, other web pages and consoles will not work. All the open widgets will be automatically closed. If the upgrade is cancelled in the middle of the wizard, need to reload this web page.

Expander update NOT success
Expander update not success. Please close this browser session and open a new browser session to reconnect to the device.
Please check the expander status is ready or the upload file is currently.

- Closing
- Preparing
- Uploading Expander image.
- Verifying Expander image.
- Flashing Expander image.
- Update finished.

4.7 Firmware safety mode

If you update process fail or primary firmware suffers some error, it will boot in safety mode.

1. If you saw the **sensor name, status LED and ID LED are abnormal, the LEDs are cross blinking**, it means firmware is in safety mode, in safety mode some function will be useless!

The screenshot shows the MEGARAC BMC web interface. The top navigation bar includes 'Dashboard', 'FRU Information', 'Server Health', 'Configuration', 'Remote Control', and 'Firmware Update'. The user is logged in as 'admin (Administrator)'. The 'Dashboard' section provides an overview of the device status.

Device Information

- Firmware Revision: 1.0.0
- Firmware Build Time: Jun 17 2014 18:47:17 CST

Network Information (Edit)

- MAC Address: 00:15:B2:A6:24:A4
- V4 Network Mode: DHCP
- IPv4 Address: 192.168.88.123
- V6 Network Mode: DHCP
- IPv6 Address: ::

Remote Control Console not supported

Sensor Monitoring

Status	Sensor	Reading	
	BMC SAFETY MODE	Not Available	🔊
	Clear the WEB	Not Available	🔊
	page cookie to	Not Available	🔊
	refresh the page	Not Available	🔊
	then you can see	Not Available	🔊
	BMC RESET	Not Available	🔊
	option and more	Not Available	🔊
	info. Follow the	Not Available	🔊
	indicator to	Not Available	🔊
	reset BMC.	Not Available	🔊

Event Logs

- Unknown (0.11%)
- Free Space (99.89%)

```

root@david ~# ipmitool -I lanplus -H 192.168.88.123 -U admin -P admin sdr
BMC SAFETY MODE | no reading | ns
Clear the WEB | no reading | ns
page cookie to | no reading | ns
refresh the page | no reading | ns
then you can see | no reading | ns
BMC RESET | no reading | ns
option and more | no reading | ns
info. Follow the | no reading | ns
indicator to | no reading | ns
reset BMC. | no reading | ns
[root@david ~]#
    
```

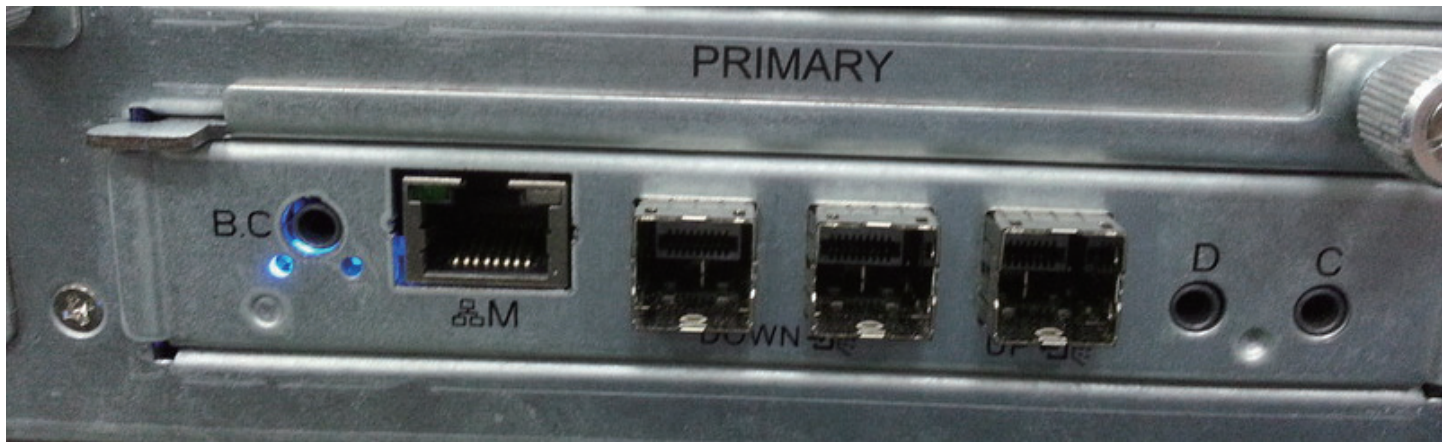

2. Please **clear browser cookies**, and re-start browser, BMC web UI will refresh web page object

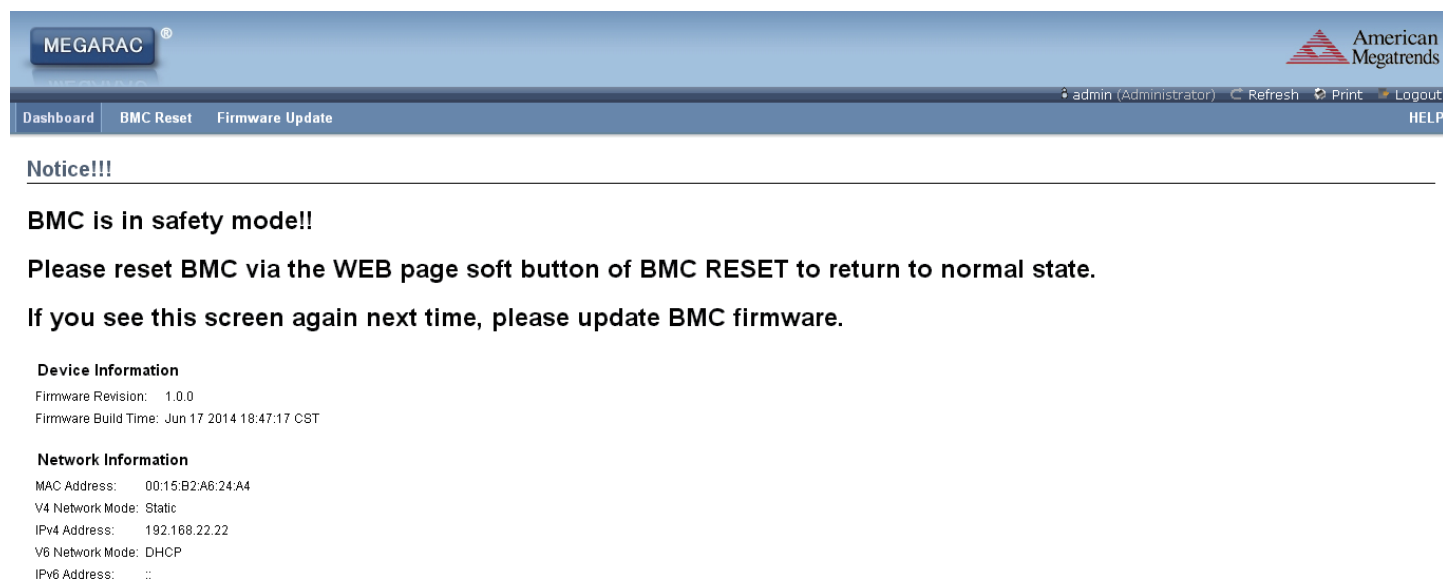

The screenshot shows the MEGARAC BMC web interface. At the top left is the MEGARAC logo. At the top right is the American Megatrends logo. Below the logos is a navigation bar with tabs for Dashboard, BMC Reset, and Firmware Update. In the top right corner of the page, there is a user menu showing 'admin (Administrator)' and options for Refresh, Print, and Logout. A 'HELP' link is also visible. The main content area features a prominent 'Notice!!!' section with a red border. The notice states: 'BMC is in safety mode!! Please reset BMC via the WEB page soft button of BMC RESET to return to normal state. If you see this screen again next time, please update BMC firmware.' Below the notice, there are two sections: 'Device Information' and 'Network Information'. The Device Information section shows 'Firmware Revision: 1.0.0' and 'Firmware Build Time: Jun 17 2014 18:47:17 CST'. The Network Information section shows 'MAC Address: 00:15:B2:A6:24:A4', 'V4 Network Mode: Static', 'IPv4 Address: 192.168.22.22', 'V6 Network Mode: DHCP', and 'IPv6 Address: ::'.

MEGARAC®

American Megatrends

admin (Administrator) Refresh Print Logout

Dashboard BMC Reset Firmware Update HELP

Notice!!!

BMC is in safety mode!!

Please reset BMC via the WEB page soft button of BMC RESET to return to normal state.

If you see this screen again next time, please update BMC firmware.

Device Information

Firmware Revision: 1.0.0
Firmware Build Time: Jun 17 2014 18:47:17 CST

Network Information

MAC Address: 00:15:B2:A6:24:A4
V4 Network Mode: Static
IPv4 Address: 192.168.22.22
V6 Network Mode: DHCP
IPv6 Address: ::

3. Click the “BMC Reset” button, into the reset page

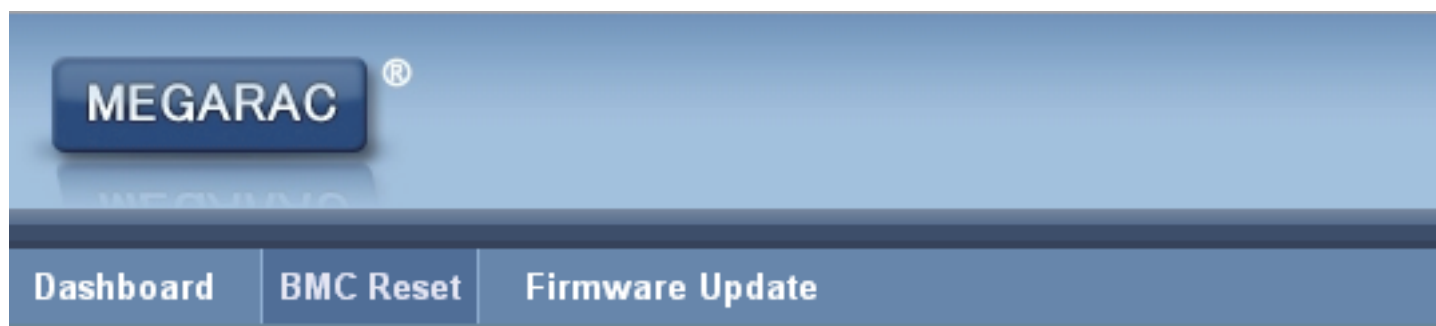

Reset BMC option

 Reset BMC

4. Select the “BMC reset”, and Click the “Perform Action” button.



5. The page will show “Requesting” status, because reset BMC, this web page will be invalid, **wait 90 seconds and clear browser cookies**, re-login web UI again.



6. If still see the safety mode page, please follow section 4.5 to do firmware update.

Chapter 5. Technical Support



www.aicipc.com

- **TAIWAN**

Tel: +886.3.313.8386

Fax: +886.3.313.8377

Email : sales@aicipc.com.tw

- **CHINA**

Tel: +86.21.54961421, +86.21.54961422

Fax: Extension: 608

Email Technical Support: support@aicipc.com

- **AMERICA - West coast**

Tel: +1.909.895.8989

Fax: +1.909.895.8999

Email : sales@aicipc.com

- **AMERICA - East coast**

Tel: +1.973.884.8886

Fax: +1.973.884.4794

Email : njsales@aicipc.com

- **EUROPE**

Tel: +31.30.6386789

Fax: +31.30.6360638

Email: sales@aicipc.nl

Email Technical Support: support@aicipc.com