

SUPER ®

SUPER ® X7SPA-L

SUPER ® X7SPA-H

SUPER ® X7SPA-HF

SUPER ® X7SPE-H

SUPER ® X7SPE-HF

SUPER ® X7SPE-H-D525

SUPER ® X7SPE-HF-D525

SUPER ® X7SPA-H-D525

SUPER ® X7SPA-HF-D525

USER'S MANUAL

Revision 1.2a

The information in this User's Manual has been carefully reviewed and is believed to be accurate. The vendor assumes no responsibility for any inaccuracies that may be contained in this document, makes no commitment to update or to keep current the information in this manual, or to notify any person or organization of the updates. **Please Note: For the most up-to-date version of this manual, please see our web site at www.supermicro.com.**

Super Micro Computer, Inc. ("Supermicro") reserves the right to make changes to the product described in this manual at any time and without notice. This product, including software and documentation, is the property of Supermicro and/or its licensors, and is supplied only under a license. Any use or reproduction of this product is not allowed, except as expressly permitted by the terms of said license.

IN NO EVENT WILL SUPER MICRO COMPUTER, INC. BE LIABLE FOR DIRECT, INDIRECT, SPECIAL, INCIDENTAL, SPECULATIVE OR CONSEQUENTIAL DAMAGES ARISING FROM THE USE OR INABILITY TO USE THIS PRODUCT OR DOCUMENTATION, EVEN IF ADVISED OF THE POSSIBILITY OF SUCH DAMAGES. IN PARTICULAR, SUPER MICRO COMPUTER, INC. SHALL NOT HAVE LIABILITY FOR ANY HARDWARE, SOFTWARE, OR DATA STORED OR USED WITH THE PRODUCT, INCLUDING THE COSTS OF REPAIRING, REPLACING, INTEGRATING, INSTALLING OR RECOVERING SUCH HARDWARE, SOFTWARE, OR DATA.

Any disputes arising between manufacturer and customer shall be governed by the laws of Santa Clara County in the State of California, USA. The State of California, County of Santa Clara shall be the exclusive venue for the resolution of any such disputes. Supermicro's total liability for all claims will not exceed the price paid for the hardware product.

FCC Statement: This equipment has been tested and found to comply with the limits for a Class B digital device pursuant to Part 15 of the FCC Rules. These limits are designed to provide reasonable protection against harmful interference in a residential installation. This equipment generates, uses, and can radiate radio frequency energy and, if not installed and used in accordance with the manufacturer's instruction manual, may cause interference with radio communications. However, there is no guarantee that interference will not occur in a particular installation. If this equipment does cause harmful interference to radio or television reception, which can be determined by turning the equipment off and on, you are encouraged to try to correct the interference by one or more of the following measures:

Reorient or relocate the receiving antenna.

Increase the separation between the equipment and the receiver.

Connect the equipment into an outlet on a circuit different from that to which the receiver is connected.

Consult the dealer or an experienced radio/television technician for help.

California Best Management Practices Regulations for Perchlorate Materials: This Perchlorate warning applies only to products containing CR (Manganese Dioxide) Lithium coin cells. "Perchlorate Material-special handling may apply. See www.dtsc.ca.gov/hazardouswaste/perchlorate".

WARNING: Handling of lead solder materials used in this product may expose you to lead, a chemical known to the State of California to cause birth defects and other reproductive harm.

Manual Revision 1.2a

Release Date: February 17, 2011

Unless you request and receive written permission from Super Micro Computer, Inc., you may not copy any part of this document. Information in this document is subject to change without notice. Other products and companies referred to herein are trademarks or registered trademarks of their respective companies or mark holders.

Copyright © 2011 by Super Micro Computer, Inc.
All rights reserved.

Printed in the United States of America

Preface

About This Manual

This manual is written for system integrators, PC technicians and knowledgeable PC users. It provides information for the installation and use of the **SUPER** X7SPA and X7SPE motherboard product series. This product is intended to be professionally installed and serviced by a technician.

About This Motherboard

The X7SPA and X7SPE motherboard product series are value-driven products aimed at users who demand a reduced-cost, low-power motherboard for PC or storage server applications.

The X7SPA and X7SPE series come in different model variations with different CPU support. The X7SPA-L features a single-core Intel® ATOM™ D410 (1.66GHz, 10.0W) processor, while the X7SPA-H, X7SPA-HF, X7SPE-H, and X7SPE-HF supports the Intel ATOM D510 (Dual Core, 1.66GHz, 13.0W) processor. In addition, four other models, the X7SPE-H-D525, X7SPA-HF-D525, X7SPA-H-D525 and the X7SPE-HF-D525 are equipped with the Intel ATOM D525 (Dual Core, 1.8GHz, 13W) processor. Depending on the particular model, X7SPA and X7SPE series also offer several configuration choices, including memory up to 4GB (non-ECC SO-DIMM), up to 6 SATA ports, an on-board VGA, and up to 10 USB 2.0 ports. These enable the X7SPA and X7SPE series to deliver cost-effective performance in a small form-factor package.

This wide selection of processors and options make the X7SPA and X7SPE series an excellent choice for system builders looking to standardize on a particular motherboard line, at cost-effective price points.

Manual Organization

Chapter 1 describes the features, specifications and performance of the mainboard and provides detailed information about the chipset. **Chapter 2** provides hardware installation instructions. Read this chapter when installing the processor, memory modules and other hardware components into the system. If you encounter any problems, see **Chapter 3**, which describes troubleshooting procedures for video, memory and system setup stored in the CMOS. **Chapter 4** includes an introduction to the BIOS and provides detailed information on running the CMOS Setup utility.

Appendix A provides BIOS Error Beep Codes. **Appendix B** lists Driver Installation Instructions.

Conventions Used in the Manual:

Special attention should be given to the following symbols for proper installation and to prevent damage done to the components or injury to yourself:



Danger/ Caution: Instructions to be strictly followed to prevent catastrophic system failure or to avoid bodily injury



Warning: Critical information to prevent damage to the components or data loss.



Important: Important information given to ensure proper system installation or to relay safety precautions.



Note: Additional Information given to differentiate various models or provides information for correct system setup.

Contacting Supermicro

Headquarters

Address: Super Micro Computer, Inc.
980 Rock Ave.
San Jose, CA 95131 U.S.A.

Tel: +1 (408) 503-8000

Fax: +1 (408) 503-8008

Email: marketing@supermicro.com (General Information)
support@supermicro.com (Technical Support)

Web Site: www.supermicro.com

Europe

Address: Super Micro Computer B.V.
Het Sterrenbeeld 28, 5215 ML
's-Hertogenbosch, The Netherlands

Tel: +31 (0) 73-6400390

Fax: +31 (0) 73-6416525

Email: sales@supermicro.nl (General Information)
support@supermicro.nl (Technical Support)
rma@supermicro.nl (Customer Support)

Asia-Pacific

Address: Super Micro Computer, Inc.
4F, No. 232-1, Liancheng Rd.
Chung-Ho 235, Taipei County
Taiwan, R.O.C.

Tel: +886-(2) 8226-3990

Fax: +886-(2) 8226-3991

Web Site: www.supermicro.com.tw

Technical Support:

Email: support@supermicro.com.tw

Tel: 886-2-8228-1366, ext.132 or 139

Table of Contents

Preface

About This Manual	iii
About This Motherboard.....	iii
Manual Organization	iii
Conventions Used in the Manual:.....	iv
Contacting Supermicro.....	v

Chapter 1 Introduction

1-1	Overview	1-1
	Checklist.....	1-1
	SUPER X7SPA-L Image	1-2
	SUPER X7SPA-H Image	1-3
	SUPER X7SPA-HF Image	1-4
	SUPER X7SPE-H Image	1-5
	SUPER X7SPE-HF Image.....	1-6
	SUPER X7SPE-H-D525 Image	1-7
	SUPER X7SPE-HF-D525 Image	1-8
	SUPER X7SPA-H-D525 Image.....	1-9
	SUPER X7SPA-HF-D525 Image	1-10
	Motherboard Layout (X7SPA-L, X7SPA-H, X7SPA-HF, X7SPA-H-D525, X7SPA-HF-D525).....	1-11
	Motherboard Layout (X7SPE-H, X7SPE-HF, X7SPE-H-D525, X7SPE- HF-D525).....	1-12
	X7SPA-L, X7SPA-H, X7SPA-HF, X7SPA-H-D525, X7SPA-HF-D525 Quick Reference.....	1-13
	X7SPE-H/X7SPE-HF, X7SPE-H-D525, X7SPE-HF-D525, Quick Reference	1-14
	Motherboard Features	1-18
	X7SPA/X7SPE Series Block Diagram	1-21
1-2	Chipset Overview	1-22
	I/O Controller Hub: ICH9R (X7SPA-H/X7SPA-HF, X7SPE-H/X7SPE-HF, X7SPE-H-D525, X7SPE-HF-D525, X7SPA-H-D525, X7SPA-HF-D525)	1-22
	I/O Controller Hub: ICH9 (X7SPA-L).....	1-22
1-3	PC Health Monitoring.....	1-23
	Recovery from AC Power Loss.....	1-23
	Onboard Voltage Monitoring	1-23
	Fan Status Monitor with Software.....	1-23
	CPU Overheat LED and Control	1-23
1-4	Power Configuration Settings.....	1-24

	Slow Blinking LED for Suspend-State Indicator	1-24
	BIOS Support for USB Keyboard.....	1-24
	Main Switch Override Mechanism	1-24
1-5	Power Supply.....	1-24
1-6	Super I/O.....	1-25
1-7	Overview of the Nuvoton BMC Controller (X7SPA-HF/X7SPE-HF/X7SPE-HF-D525/X7SPA-HF-D525 only).....	1-25
1-8	LVDS (X7SPA-L only).....	1-26
Chapter 2 Installation		
2-1	Static-Sensitive Devices.....	2-1
	Precautions	2-1
	Unpacking	2-1
	Tools Needed	2-2
	Location of Mounting Holes	2-2
2-2	Motherboard Installation.....	2-2
	Installation Instructions.....	2-3
2-3	System Memory	2-4
	How to Install SO DIMMs	2-4
	Memory Support.....	2-4
	The SO DIMM Socket.....	2-5
2-4	Connectors/I/O Ports.....	2-6
	Back Panel Connectors and I/O Ports.....	2-6
	ATX PS/2 Keyboard and PS/2 Mouse Ports.....	2-7
	Universal Serial Bus (USB).....	2-8
	Serial Ports.....	2-9
	VGA Connector	2-10
	LAN Ports / IPMI	2-11
	Front Control Panel.....	2-12
	JF1 Header Pins	2-12
	Front Control Panel Pin Definitions.....	2-13
	Power LED	2-13
	HDD LED.....	2-13
	NIC1/NIC2 LED Indicators	2-13
	Overheat (OH)/Fan Fail LED.....	2-14
	Power Fail LED	2-14
	Reset Button	2-15
	Power Button	2-15
	NMI Button	2-15
2-5	Connecting Cables.....	2-16

	ATX Main PWR & CPU PWR Connectors	2-16
	External Power Connector	2-16
	Fan Headers.....	2-17
	Overheat/Fan Fail LED (JOH).....	2-18
	Front Panel Audio Header (X7SPA-L Only)	2-18
	Chassis Intrusion	2-19
	SATA DOM Power	2-19
	Power SMB I ² C Connector	2-19
	CD Header (X7SPA-L Only).....	2-20
	SMB.....	2-20
	T-SGPIO 0/1 Headers	2-20
	LVDS Connector (X7SPA-L Only).....	2-21
	Inverter Power Connector (X7SPA-L Only)	2-21
	TPM Header(X7SPE-H-D525, X7SPE-HF-D525 Only).....	2-22
2-6	Jumper Settings	2-23
	Explanation of Jumpers.....	2-23
	LAN Port Enable/Disable	2-24
	SMB (I ² C) Bus to PCI Slots.....	2-24
	CMOS Clear	2-25
	USB Wake-Up (Not Available on the X7SPE-H-D525, X7SPA-H-D525, X7SPA-HF-D525 and X7SPE-HF-D525).....	2-26
	TPM Support Enable (Not available on X7SPA-H-D525, X7SPA-HF-D525, X7SPE-H-D525, X7SPE-HF-D525).....	2-27
	Watch Dog Enable/Disable	2-27
	COM3 Redirection Select (OEM Option).....	2-27
	Power LED/Speaker.....	2-28
	BMC (X7SPA-HF, X7SPE-HF, X7SPE-HF-D525, X7SPA-H-D525, X7SPA- HF-D525 Only)	2-28
	VGA Enable (X7SPA-HF, X7SPE-HF, X7SPE-HF-D525, X7SPA-HF-D525 only).....	2-29
	HDA/AC97 Select (X7SPA-L Only)	2-29
	Power Force On Enable/Disable.....	2-30
	DCD / P5V Select	2-30
2-7	Onboard Indicators.....	2-31
	LAN Port LEDs.....	2-31
2-8	Serial ATA and HDD Connections.....	2-32
	SATA Connectors	2-32

Chapter 3 Troubleshooting

3-1	Troubleshooting Procedures	3-1
	Before Power On	3-1
	No Power	3-1
	No Video	3-1
	Memory Errors	3-2
	Losing the System's Setup Configuration	3-2
3-2	Technical Support Procedures	3-2
3-3	Frequently Asked Questions	3-3
3-4	Returning Merchandise for Service.....	3-5

Chapter 4 BIOS

4-1	Introduction.....	4-1
	Starting BIOS Setup Utility.....	4-1
	How To Change the Configuration Data	4-1
	How to Start the Setup Utility	4-2
4-2	Main Setup.....	4-2
	System Overview: The following BIOS information will be displayed:.....	4-3
	System Time/System Date	4-3
	Processor	4-3
	System Memory	4-3
4-3	Advanced Setup Configurations.....	4-4
	▶BOOT Feature.....	4-4
	Quick Boot.....	4-4
	Quiet Boot	4-4
	AddOn ROM Display Mode.....	4-4
	Bootup Num-Lock.....	4-5
	PS/2 Mouse Support	4-5
	Wait For 'F1' If Error.....	4-5
	Hit 'Del' Message Display	4-5
	Watch Dog Function.....	4-5
	Power Button Function.....	4-5
	Restore on AC Power Loss.....	4-5
	Interrupt 19 Capture	4-5
	Standby Power in S5	4-6
	▶CPU Configuration	4-6
	Clock Spread Spectrum	4-6
	Max CPUID Value Limit.....	4-6

Execute-Disable Bit Capability (Available when supported by the OS and the CPU).....	4-6
Hyper-threading Technology.....	4-6
▶Advanced Chipset Control.....	4-7
▶Northbridge Configuration	4-7
DRAM Frequency.....	4-7
Configure DRAM Timing by SPD	4-7
DRAM CAS# Latency	4-7
DRAM RAS# to CAS# Delay	4-7
DRAM RAS# Precharge.....	4-7
DRAM RAS# Activate to Precharge	4-7
Initiate Graphics Adapter.....	4-7
Internal Graphics Mode Select.....	4-7
▶Video Function Configuration (X7SPA-L, X7SPE-H, X7SPA-H-D525 and X7SPE-H-D525 only)	4-8
DVMT Mode Select.....	4-8
DVMT/Fixed Memory	4-8
Boot Display Device.....	4-8
Alternate Video BIOS.....	4-8
Active State Power Management.....	4-8
Reserved Page Route.....	4-8
USB Functions	4-8
Legacy USB Support (available if USB Functions above is Enabled).....	4-8
USB Controller	4-9
▶IDE/SATA Configuration	4-9
SATA#1 Configuration	4-9
SATA#2 Configuration (Available if IDE is enabled under "Configure SATA#1 as" above)	4-9
IDE Detect Timeout (sec).....	4-9
Primary IDE Master/Slave,Secondary IDE Master/Slave,Third IDE Master,Fourth IDE Master	4-9
▶PCI/PnP Configuration	4-11
Clear NVRAM.....	4-11
Plug & Play OS	4-12
PCI Latency Timer.....	4-12
PCI IDE Bus Master.....	4-12
ROM Scan Ordering.....	4-12
PCI Slot 1.....	4-12
Load Onboard LAN 1 Option ROM/ Load Onboard LAN 2 Option ROM.....	4-12

▶ Super IO Device Configuration	4-12
Serial Port1 Address/ Serial Port2 Address	4-12
▶ Remote Access Configuration	4-13
Remote Access	4-13
▶ Hardware Health Configuration.....	4-14
CPU Overheat Alarm.....	4-14
CPU Temperature.....	4-14
System Temperature	4-14
CPUFAN / SYSFAN Speed.....	4-15
Fan Speed Control Modes.....	4-16
CPU Vcore, AVCC, 3.3Vcc, 12V, V_DIMM, 5V, -12V, 3.3Vsb, and Vbat	4-16
▶ ACPI Configuration.....	4-16
High Performance Event Timer.....	4-16
USB Device Wakeup.....	4-16
PS/2 KB/MS WakeUp.....	4-16
ACPI Aware O/S.....	4-17
Suspend Mode	4-17
AMI OEMB Table.....	4-17
ACPI APIC Support.....	4-17
APIC ACPI SCI IRQ.....	4-17
Headless Mode	4-17
ACPI Version Features.....	4-17
▶ IPMI Configuration (X7SPA-HF, X7SPE-HF, X7SPE-HF-D525 & X7SPA-HF-D525 Only)	4-17
IPMI Firmware Revision	4-17
Status of BMC	4-18
IPMI Function	4-18
View BMC System Event Log.....	4-18
Clear BMC System Event Log.....	4-18
Set LAN Configuration	4-18
BMC Watch Dog Timer Action	4-19
▶ Event Log Configuration.....	4-19
View Event Log	4-19
Mark all events as read.....	4-19
Clear event log.....	4-19
PCIE Error Log.....	4-19
4-4 Security Settings	4-20
Supervisor Password	4-20
User Password:.....	4-20

	Change Supervisor Password.....	4-20
	Change User Password	4-21
	Boot Sector Virus Protection.....	4-21
4-5	Boot Settings	4-22
	▶ Boot Device Priority.....	4-22
	▶ Hard Disk Drives	4-22
	▶ Removable Drives	4-23
	Retry Boot Devices	4-23
4-6	Exit Options.....	4-23
	Save Changes and Exit	4-23
	Discard Changes and Exit	4-24
	Discard Changes.....	4-24
	Load Optimal Defaults.....	4-24
	Load Fail-Safe Defaults.....	4-24

Appendix A POST Error Beep Codes

	Recoverable POST Error Beep Codes	A-1
--	---	-----

Appendix B Software Installation Instructions

B-1	Installing Drivers.....	B-1
B-2	Configuring Supero Doctor III	B-2

Chapter 1

Introduction

1-1 Overview

Checklist

Congratulations on purchasing your computer motherboard from an acknowledged leader in the industry. Supermicro boards are designed with the utmost attention to detail and to provide you with the highest standards in quality and performance.

Please check that the following items have all been included with your motherboard. If anything listed here is damaged or missing, contact your retailer.

All the following items are included in the retail box only.

- One (1) Supermicro Mainboard
- Two (2) SATA cables (CBL-0044L)
- One (1) I/O shield (MCP-260-00039-0N)
- One (1) Supermicro CD containing drivers and utilities (CDR-X7-UP)
- One (1) User's/BIOS Manual (MNL-1166)

SUPER X7SPA-L Image

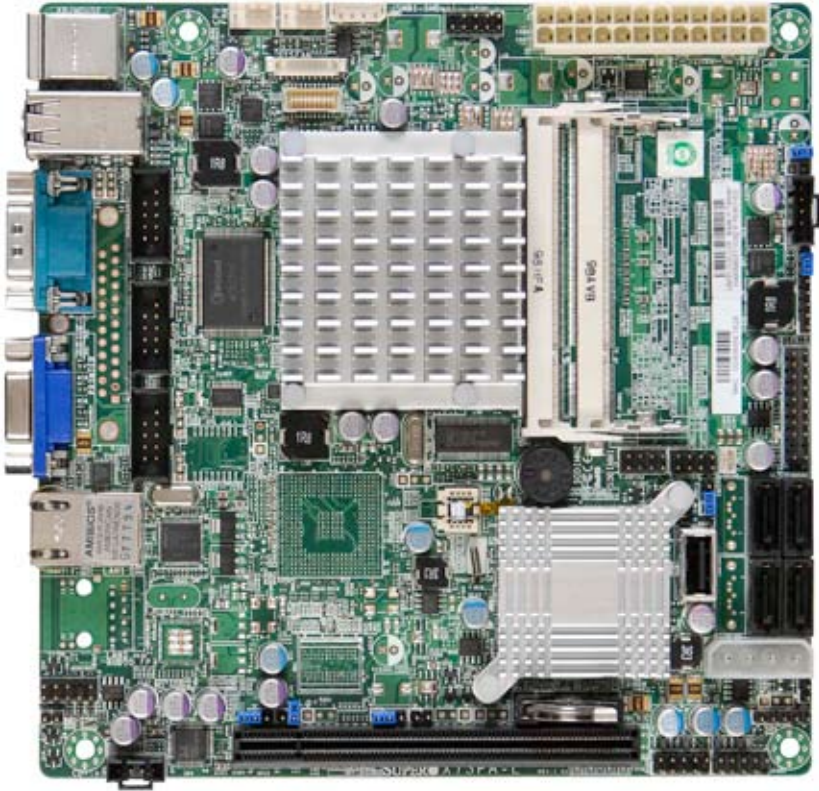

Note: All graphics and images shown in this manual were based upon the latest PCB Revision available at the time of publishing of the manual. The motherboard you've received may or may not look exactly the same as the image shown in this manual.

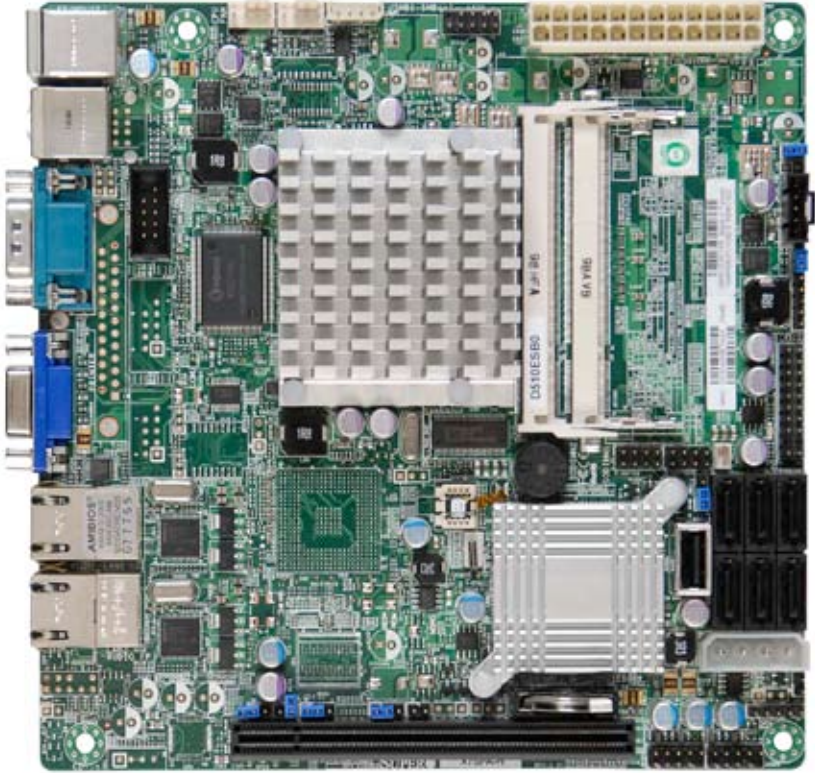
SUPER X7SPA-H Image

Note: All graphics and images shown in this manual were based upon the latest PCB Revision available at the time of publishing of the manual. The motherboard you've received may or may not look exactly the same as the image shown in this manual.

SUPER X7SPA-HF Image

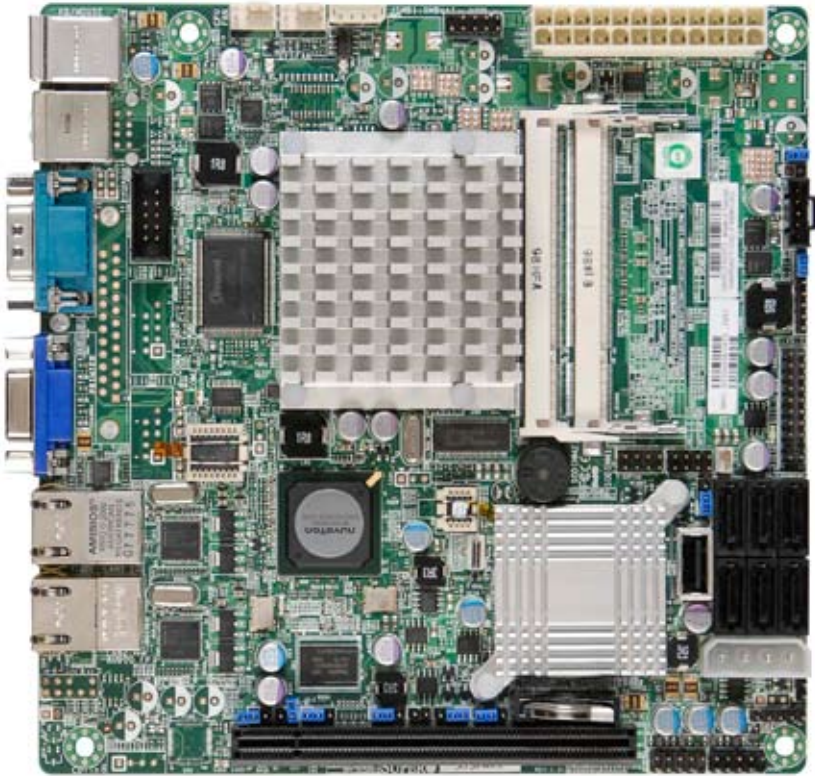

Note: All graphics shown in this manual were based upon the latest PCB Revision available at the time of publishing of the manual. The motherboard you've received may or may not look exactly the same as the graphics shown in this manual.

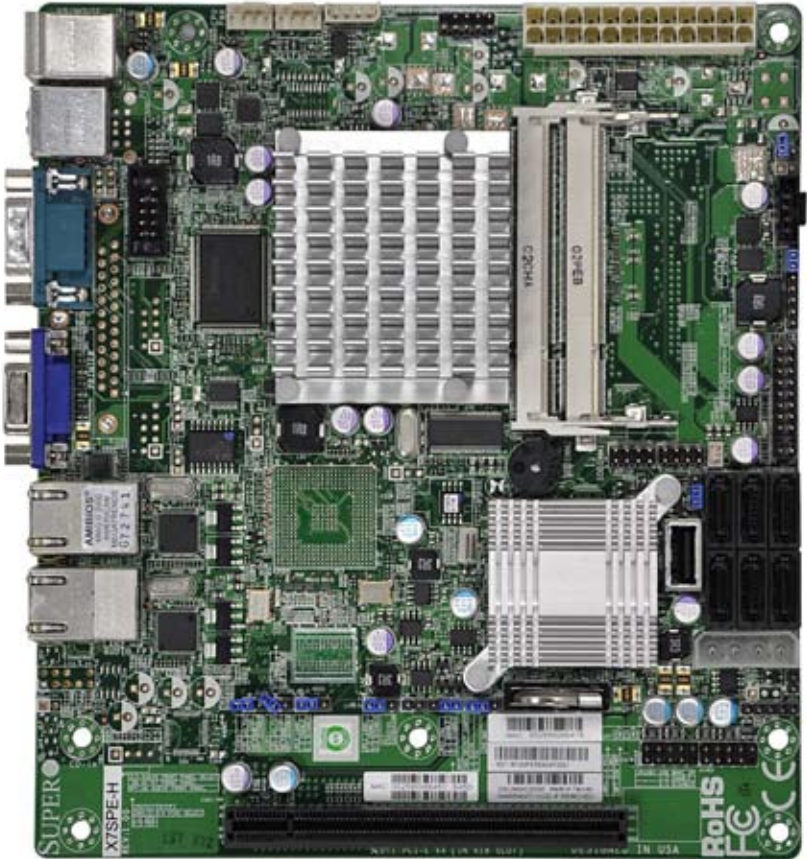
SUPER X7SPE-H Image

Note: All graphics shown in this manual were based upon the latest PCB Revision available at the time of publishing of the manual. The motherboard you've received may or may not look exactly the same as the graphics shown in this manual.

SUPER X7SPE-HF Image

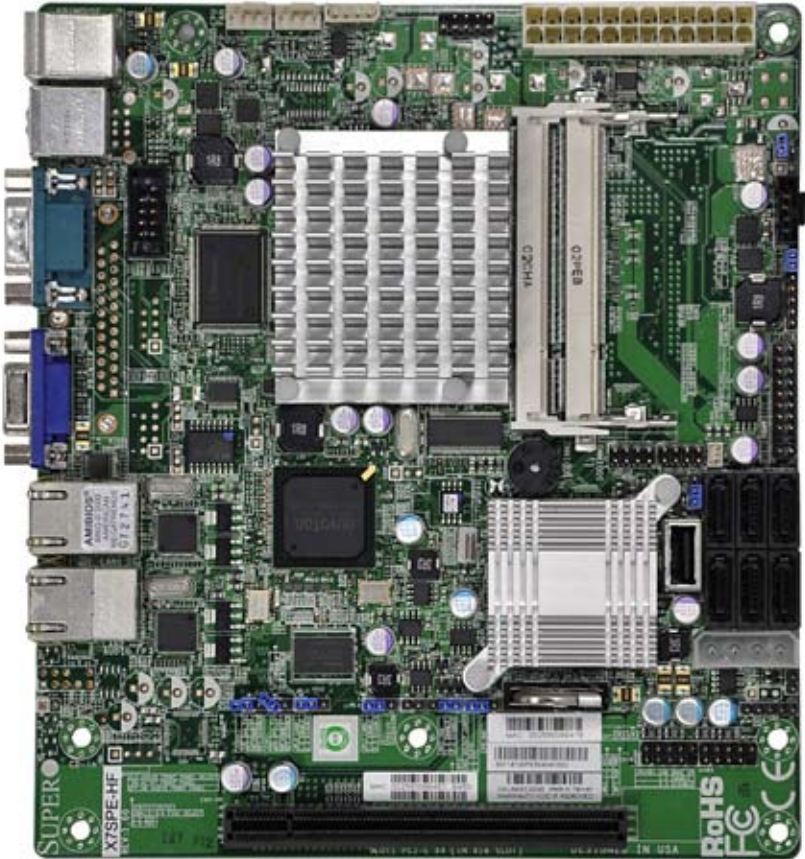

Note: All graphics and images shown in this manual were based upon the latest PCB Revision available at the time of publishing of the manual. The motherboard you've received may or may not look exactly the same as the image shown in this manual.

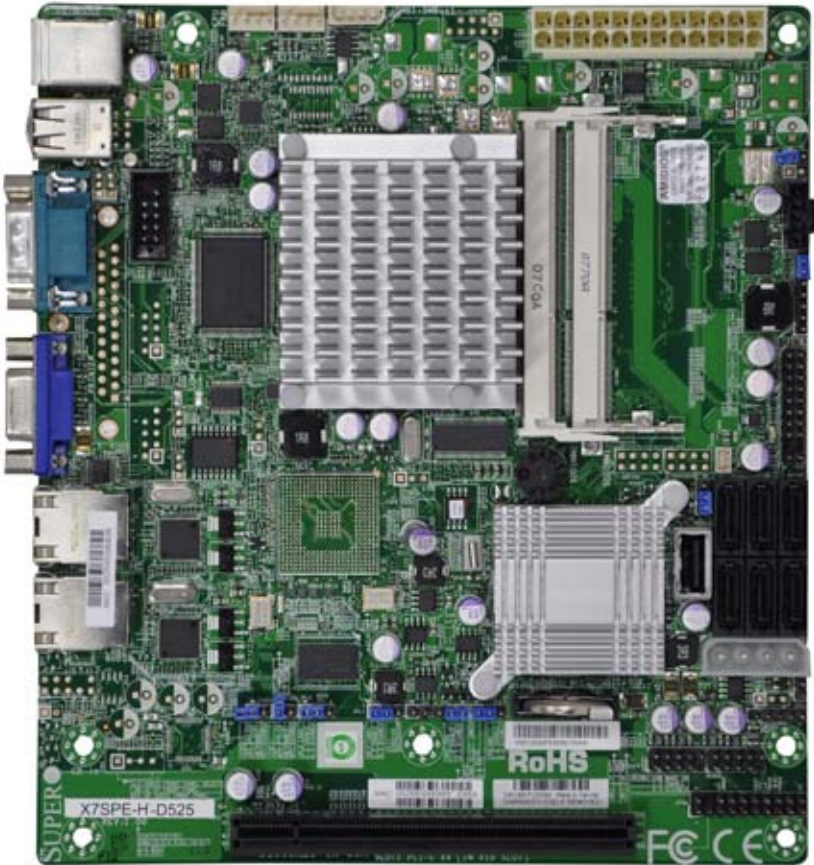
SUPER X7SPE-H-D525 Image

Note: All graphics and images shown in this manual were based upon the latest PCB Revision available at the time of publishing of the manual. The motherboard you've received may or may not look exactly the same as the image shown in this manual.

SUPER X7SPE-HF-D525 Image

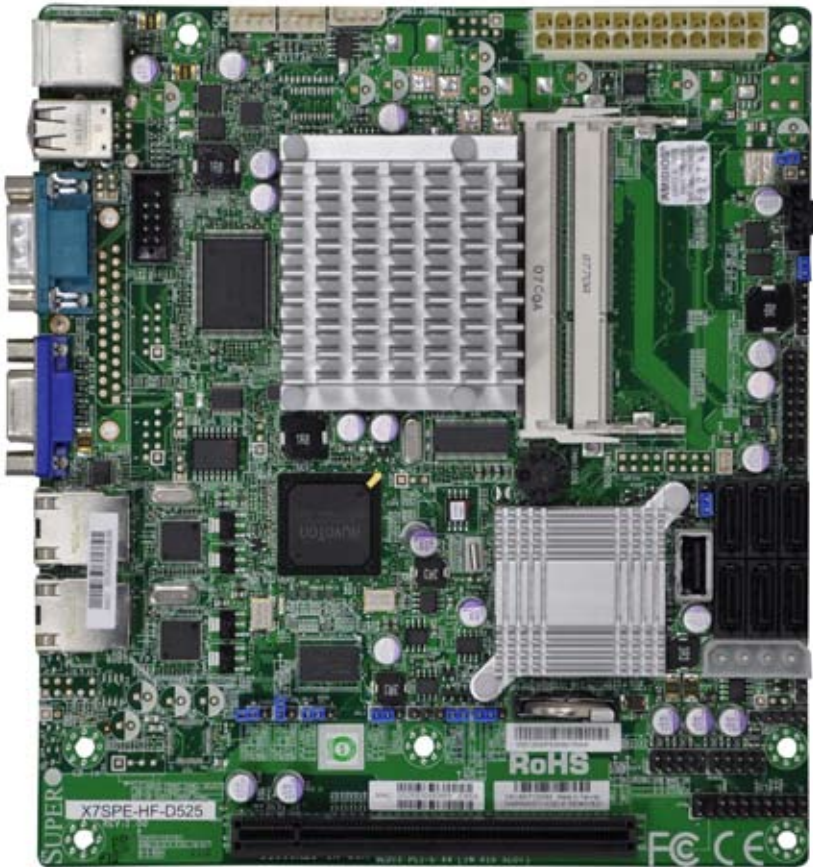

Note: All graphics and images shown in this manual were based upon the latest PCB Revision available at the time of publishing of the manual. The motherboard you've received may or may not look exactly the same as the image shown in this manual.

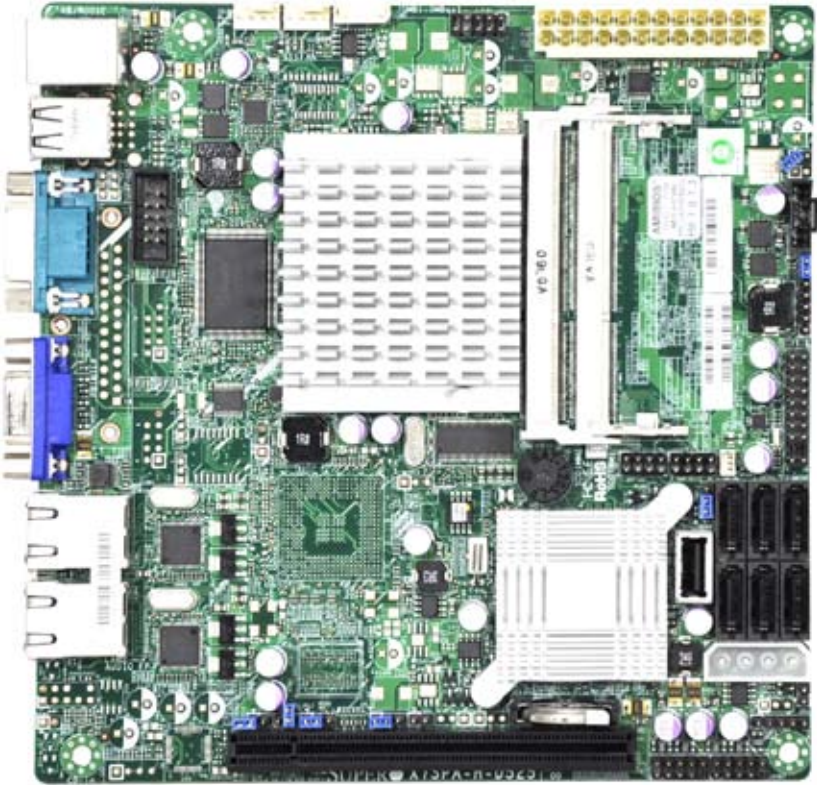
SUPER X7SPA-H-D525 Image

Note: All graphics and images shown in this manual were based upon the latest PCB Revision available at the time of publishing of the manual. The motherboard you've received may or may not look exactly the same as the image shown in this manual.

SUPER X7SPA-HF-D525 Image

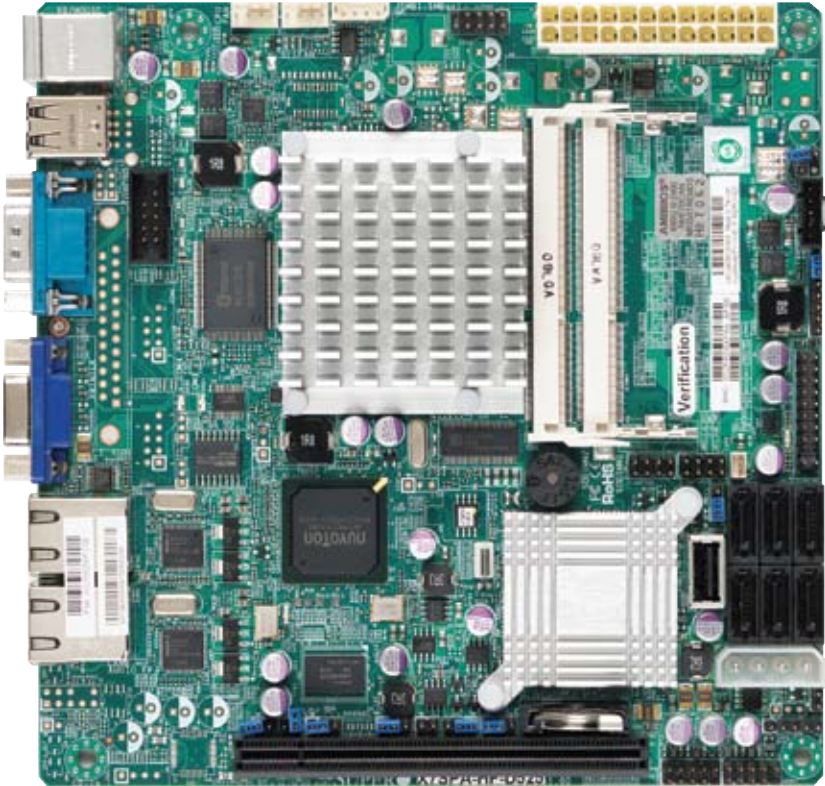

Note: All graphics and images shown in this manual were based upon the latest PCB Revision available at the time of publishing of the manual. The motherboard you've received may or may not look exactly the same as the image shown in this manual.

Motherboard Layout (X7SPA-L, X7SPA-H, X7SPA-HF, X7SPA-H-D525, X7SPA-HF-D525)

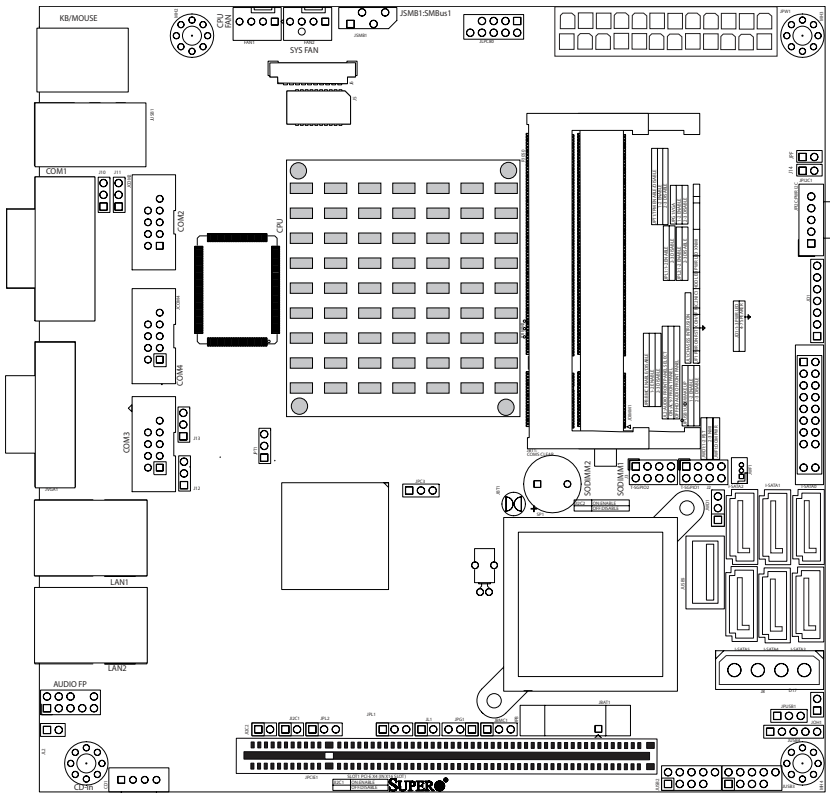

Important Notes to the User

- Jumpers not indicated are for testing only.
- See Chapter 2 for detailed information on jumpers, I/O ports and JF1 front panel connections.
- "■" indicates the location of "Pin 1".

Motherboard Layout (X7SPE-H, X7SPE-HF, X7SPE-H-D525, X7SPE-HF-D525)

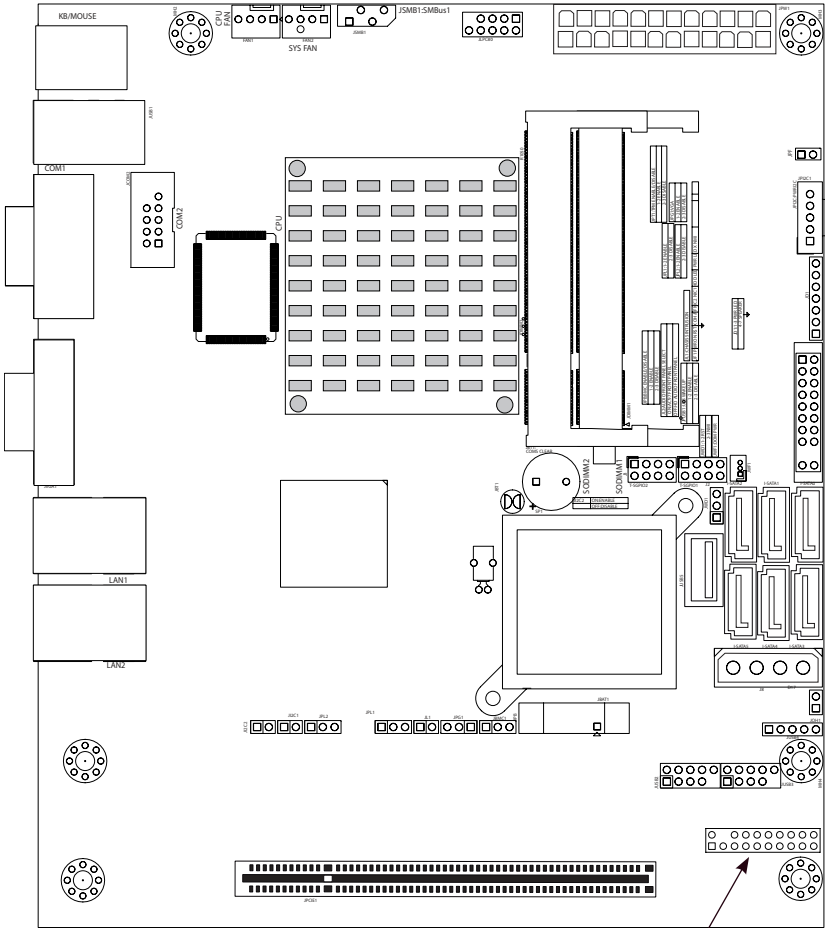

X7SPE-H-D525 and X7SPE-HF-D525 Only.

Important Notes to the User

- Jumpers not indicated are for testing only.
- See Chapter 2 for detailed information on jumpers, I/O ports and JF1 front panel connections.
- "■" indicates the location of "Pin 1".

X7SPA-L, X7SPA-H, X7SPA-HF, X7SPA-H-D525, X7SPA-HF-D525 Quick Reference

(not drawn to scale)

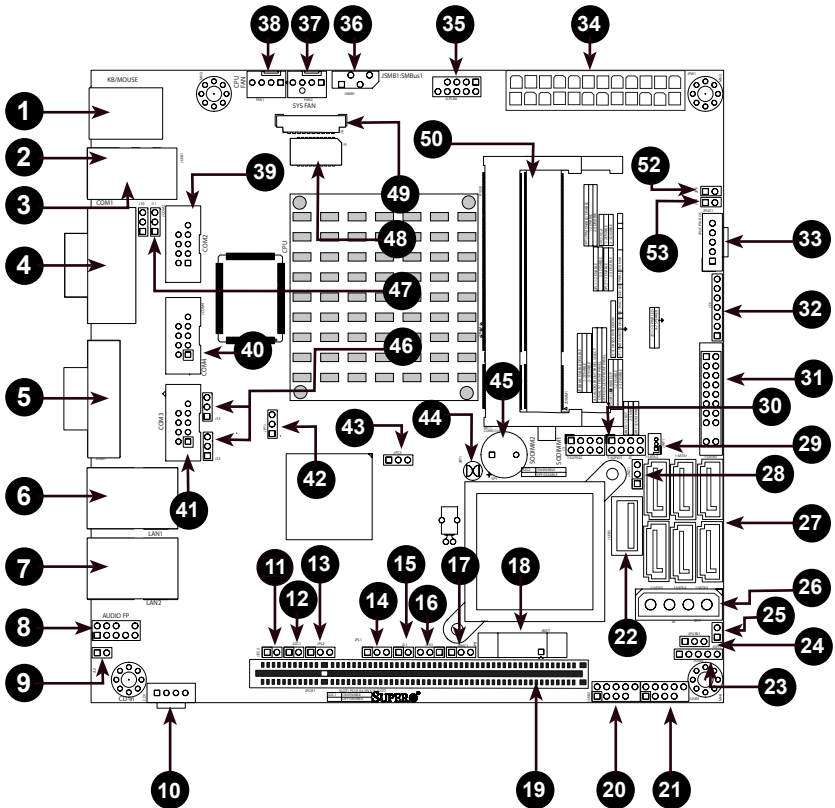

Note 1: USB 3/4, COM3/4 are available on the X7SPA-L only. LAN2 and SATA 2/3 are available on the X7SPA-H, X7SPA-HF, X7SPE-H, X7SPE-HF, X7SPA-H-D525, X7SPA-HF-D525, X7SPE-H-D525 and X7SPE-HF-D525 only.



Note 2: Jumpers that are not indicated are used for factory testing only.

X7SPE-H/X7SPE-HF, X7SPE-H-D525, X7SPE-HF-D525, Quick Reference

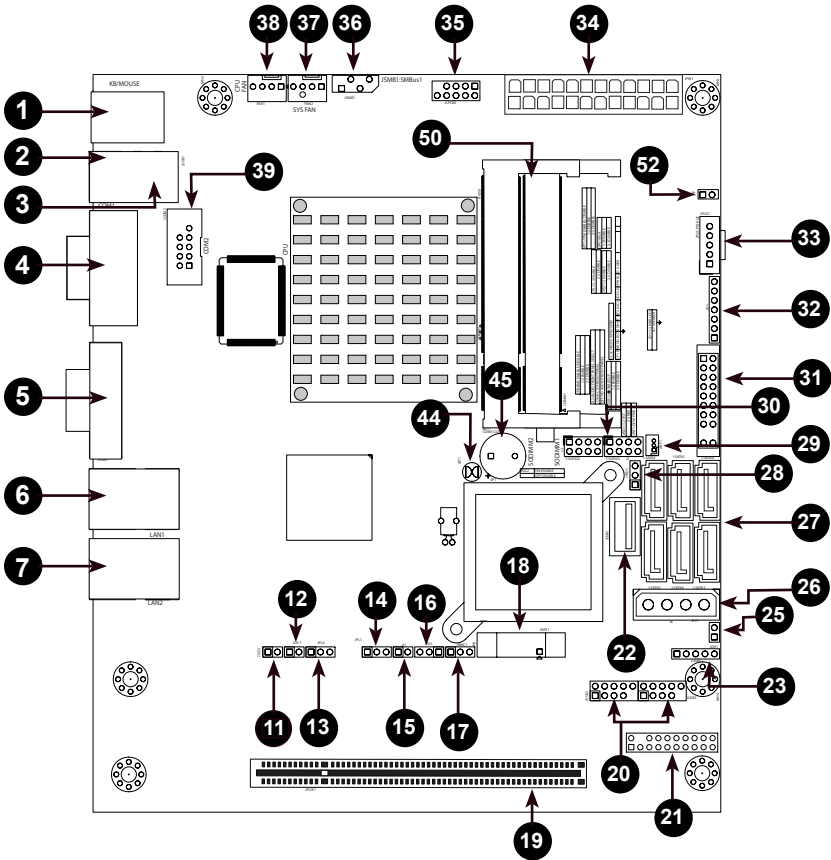

Note 1: USB 3/4, COM3/4 are available on the X7SPA-L only. LAN2 and SATA 2/3 are available on the X7SPA-H, X7SPA-HF, X7SPE-H, X7SPE-HF, X7SPA-H-D525, X7SPA-HF-D525, X7SPE-H-D525 and X7SPE-HF-D525 only.



Note 2: Jumpers that are not indicated are used for factory testing only.

Ports and Connectors

Number	Connectors	Description
1	KB/Mouse	PS/2 Keyboard/Mouse
2, 3	USB 1/2, USB 3/4	Back Panel USB Ports (USB 3/4: X7SPA-L only)
4	COM1	Back Panel Serial Port
5	VGA	Video/Graphics Connector
6	LAN1	RJ45 Connector for LAN1
7	LAN2	RJ45 Connector for LAN2 (Not available on the X7SPA-L)
8	J5	Front Panel Audio Header Connector (Not available on the X7SPE series)
10	CD1	CD/DVD Drive Audio Input Header (Not available on the X7SPE series)
15	JL1	Chassis Intrusion Header
18	JBAT1	Onboard Battery
19	JPCI E1	PCI-E 1.1 x4 Gen1 (in x16 physical) Slot 7 (Slot 6 on X7SPE series)
20	USB 5/6, 7/8	Front Panel USB headers
21	JTPM	TPM Header (X7SPE-H-D525/X7SPE-HF-D525 Only)
22	USB 10	Type A on-board USB Port
23	USB 9	Front Panel USB header
25	JOH	Overheat Warning LED header
26	J8	Power Connector for Add-on devices (Note: Do NOT plug the power supply into this socket).
27	SATA 0,1,2,3,4,5	SATA Connectors (SATA 2/3 is not available on the X7SPA-L)
29	JWF1	SATA Disk on Module (DOM) Power
30	T-SGPIO-0/1	Serial General Purpose IO headers (for SATA)
31	JF1	FP Control Panel Header
32	JD1	External Buzzer/Speaker/Power LED Pins 1-3 (Power LED), Pins 4-7 (External Speaker)
33	JPI2C	PWR supply (I ² C) System Management Bus
34	JPW1	ATX 24-Pin Power Connector
35	Unused	Factory Test Point
36	JSMB1	System Management Bus header
38, 37	Fans 1, 2	Fan 1: CPU Fan, Fan 2: Chassis Fan Header
39, 40, 41	COM2, COM4, COM3	Serial Port 2, 4 and 3 Headers (COM 3/4 X7SPA-L only)
45	SPK	Onboard Speaker/Buzzer
48	J5	18-bpp LVDS LCD Monitor Port
49	J6	Inverter Connector
50	DIMM 1, DIMM 2	SO-DIMM Memory Slots

Jumper Descriptions

Number	Jumper	Description	Default Setting
9	JL2	AC97/HD Audio Selector (Front Panel)	Open (HD Audio) Closed (AC97)
12, 11	J ² C1/J ² C2	SMB to PCI Slots	Open/Open (Disabled)
13	JPL2	LAN2 Enable/Disable	Pins 1-2 (Enabled)
14	JPL1	LAN1 Enable/Disable	Pins 1-2 (Enabled)
16	JPG1	On-board VGA Enable/Disable (X7SPA-HF, X7SPE-HF and X7SPE-HF-D525 only)	Pins 1-2 (Enabled, use on-board VGA device) Pins 2-3 (Disabled, use add-on VGA card)
17	JPB	BMC Enable/Disable (X7SPA-HF, X7SPE-HF, and X7SPE-HF-D525 only)	Pins 1-2 (Enabled) Pins 2-3 (Disabled)
24	JPUSB1	USB Wake-up Enable	Pins 1-2 (Enabled)
28	JWD1	Watch Dog Timer	Pins 1-2 (Reset)
42	JPT1	Trusted Platform Module Enable	Pins 1-2 (Enabled) Pins 2-3 (Disabled)
43	JPC3	COM3 Selection (OEM option for the X7SPA-H, X7SPA-HF and X7SPE series)	Pins 1-2 (RS232) Pins 2-3 (TTL)
44	JBT1	CMOS Clear	(See Chapter 2)
46	J12/J13	Pin 1 DCD/P5V Select (COM3/COM4) (OEM option for the X7SPA-H, X7SPA-HF, and X7SPE series)	Pins 1-2 (DCD) Pins 2-3 (P5V)
47	J10/J11	Pin 1 DCD/P5V Select (COM1/COM2) (OEM option for the X7SPA-H, X7SPA-HF, and X7SPE series)	Pins 1-2 (DCD) Pins 2-3 (P5V)
52	JPF	Power Force On	Open (Disabled)
53	J14	Reserved (Unused)	Reserved (Unused)

Features

Model	CPU	Chipset	VGA Graphics
X7SPA-L	Intel ATOM D410	Intel ICH9	Intel Graphics Media Accelerator GMA3150
X7SPA-H	Intel ATOM D510	Intel ICH9R	Intel Graphics Media Accelerator GMA3150
X7SPA-HF	Intel ATOM D510	Intel ICH9R	Matrox G200eW Graphics Accelerator
X7SPE-H	Intel ATOM D510	Intel ICH9R	Intel Graphics Media Accelerator GMA3150
X7SPE-HF	Intel ATOM D510	Intel ICH9R	Matrox G200eW Graphics Accelerator
X7SPE-H-D525	Intel ATOM D525	Intel ICH9R	Intel Graphics Media Accelerator GMA3150
X7SPE-HF-D525	Intel ATOM D525	Intel ICH9R	Matrox G200eW Graphics Accelerator
X7SPA-H-D525	Intel ATOM D525	Intel ICH9R	Intel Graphics Media Accelerator GMA3150
X7SPA-HF-D525	Intel ATOM D525	Intel ICH9R	Matrox G200eW Graphics Accelerator

Model	USB	Serial	LAN	Audio	LVDS	SATA	IPMI	RAID	TPM
X7SPA-L	4 (rear) 1 (type A) 5 (header)	1 (rear) 3 (header)	LAN1	Front Panel Header	1	4	No	No	No
X7SPA-H	2 (rear) 1 (type A) 5 (header)	1 (rear) 1 (header)	LAN1/ LAN2	None	None	6	No	Windows (0,1,5,10) Linux (0,1,10)	No
X7SPA- HF	2 (rear) 1 (type A) 5 (header)	1 (rear) 1 (header)	LAN1/ LAN2	None	None	6	Yes (shared on LAN1)	Windows (0,1,5,10) Linux (0,1,10)	No
X7SPE-H	2 (rear) 1 (type A) 5 (header)	1 (rear) 1 (header)	LAN1/ LAN2	None	None	6	No	Windows (0,1,5,10) Linux (0,1,10)	No
X7SPE- HF	2 (rear) 1 (type A) 5 (header)	1 (rear) 1 (header)	LAN1/ LAN2	None	None	6	Yes (shared on LAN1)	Windows (0,1,5,10) Linux (0,1,10)	No
X7SPE- H-D525	2 (rear) 1 (type A) 5 (header)	1 (rear) 1 (header)	LAN1/ LAN2	None	None	6	No	Windows (0,1,5,10) Linux (0,1,10)	Yes
X7SPE- HF-D525	2 (rear) 1 (type A) 5 (header)	1 (rear) 1 (header)	LAN1/ LAN2	None	None	6	Yes (shared on LAN1)	Windows (0,1,5,10) Linux (0,1,10)	Yes
X7SPA-H- D525	2 (rear) 1 (type A) 5 (header)	1 (rear) 1 (header)	LAN1/ LAN2	None	None	6	No	Windows (0,1,5,10) Linux (0,1,10)	No
X7SPA- HF-D525	2 (rear) 1 (type A) 5 (header)	1 (rear) 1 (header)	LAN1/ LAN2	None	None	6	Yes (shared on LAN1)	Windows (0,1,5,10) Linux (0,1,10)	No

Motherboard Features

Processor

X7SPA-L

Single Integrated Intel®ATOM™ D410 processor, 1.66 GHz, 10 Watts, 512KB L2 cache, Single Core, Dual Threads.

X7SPA-H, X7SPA-HF, X7SPE-H, X7SPE-HF

Single Integrated Dual-Core Intel® ATOM™ D510 processor, 1.66 GHz, 13 Watts, 2 x 512KB L2 cache, Dual Core, 4 Threads.

X7SPE-H-D525, X7SPE-HF-D525, X7SPA-H-D525, X7SPA-HF-D525

Single Integrated Dual-Core Intel® ATOM™ D525 processor, 1.8 GHz, 13 Watts, 2 x 512KB L2 cache, Dual Core, 4 Threads.

Memory

X7SPA-L, X7SPA-H, X7SPA-HF, X7SPE-H, X7SPE-HF

Supports up to 4GB of unbuffered 667/800 MHz Non-ECC DDR2 SO-DIMMs in 2 sockets (1.8V, 256MB, 512MB, 1GB, 2GB)

X7SPE-H-D525, X7SPE-HF-D525, X7SPA-HF-D525, X7SPA-H-D525

Supports up to 4GB of unbuffered 800 MHz Non-ECC DDR3 SO-DIMMs in 2 sockets (1.5V, 256MB, 512MB, 1GB, 2GB)



Note: 1666 MHz and 1333 MHz memory may be used, but will operate at 800 MHz.

Chipset

X7SPA-L Only

Intel® ICH9

X7SPA & X7SPE Series

Intel® ICH9R

Integrated Graphics

X7SPA-L, X7SPA-H, X7SPE-H, X7SPE-H-D525, X7SPA-H-D525

Intel Graphics Media Accelerator GMA3150

X7SPA-HF, X7SPE-HF, X7SPE-HF-D525, X7SPA-HF-D525

Matrox G200eW Graphics Accelerator

Expansion Slots

- One (1) PCI-E 1.1 x4 Gen1 (in x16 physical) slot

BIOS

- 32 Mb AMI BIOS®, SPI Flash BIOS

PC Health Monitoring

- Onboard voltage monitors for CPU Cores, Chipset Voltage, Memory Voltage +1.8V, +3.3V, +5V, +/- 12V, +3.3V standby, +5V standby, VBat, HT
- Tachometer monitoring
- Status monitor for speed control, on/off control
- Supports 3-pin fans (w/o speed control)
- Low-noise fan speed control
- Temperature monitor for chassis, CPU environments
- CPU thermal trip support
- Supero Doctor III, Watch Dog/NMI
- CPU/System overheat LED, Suspend state LED

Power Configuration

- ACPI/ACPM Power Management
- Wake-On-Ring, Wake-On-LAN headers
- Keyboard wake-up from soft off
- CPU fan auto-off in sleep mode
- Power on mode for AC power recovery

I/O Controllers and Ports

- Built-in ICH9/9R SATA Controller
- Winbond Super I/O controller 83627DHG-P
- One PS/2 mouse and one PS/2 keyboard port
- One back panel VGA port

X7SPA-L Only

- 4 SATA connectors for 4 devices
- Single 10/100/1000 LAN (Intel 82574L)
- Four Fast 16550-compatible UART serial ports (one on back panel, three internal headers)
- Realtek ALC888-VC2-GR HD Audio
- Ten (10) USB 2.0 ports & headers (USB1~USB10): Four ports on the back panel, five USB headers for front panel access, and one on-board Type A USB port.
- Front panel HD audio header, 18-bpp LVDS connector
- Optimized for the Supermicro 1U SC512 & SC731 chassis.

X7SPA-H/X7SPE-H/X7SPE-H-D525/X7SPA-H-D525 Only

- 6 SATA connectors for 6 devices
- RAID support: RAID 0, 1, 5, 10 (Windows OS), RAID 0, 1, 10 (Linux OS)
- Dual 10/100/1000 LAN (Intel 82574L)
- Two Fast UART 16550-compatible serial ports (one back panel, one header)
- Eight (8) USB 2.0 ports & headers (USB1/2, USB5~10): Two ports on the back panel, five USB headers for front panel access, and one on-board Type A USB port.
- Optimized for the Supermicro 1U (502, 503, 510, 512) & SC731 chassis.
- 20-pin TPM header (X7SPE-H-D525 only)

X7SPA-HF/X7SPE-HF/X7SPE-HF-D525, X7SPA-HF-D525 Only

- All the features of the X7SPA-H/X7SPE-H/X7SPE-H-D525/X7SPA-H-D525
- Nuvoton WPCM450 BMC (Integrated IPMI 2.0, shared with LAN1)

Other

- Chassis Intrusion Header and Detection
- Lead free

CD Utilities

- BIOS flash upgrade utility, Drivers and utilities for Intel® ICH9/9R chipset

Dimensions

- Mini ITX form factor, 6.75" x 6.75" (X7SPA Series)
- Flex ITX form factor, 7.5" x 6.75" (X7SPE Series)

X7SPA/X7SPE Series BLOCK DIAGRAM

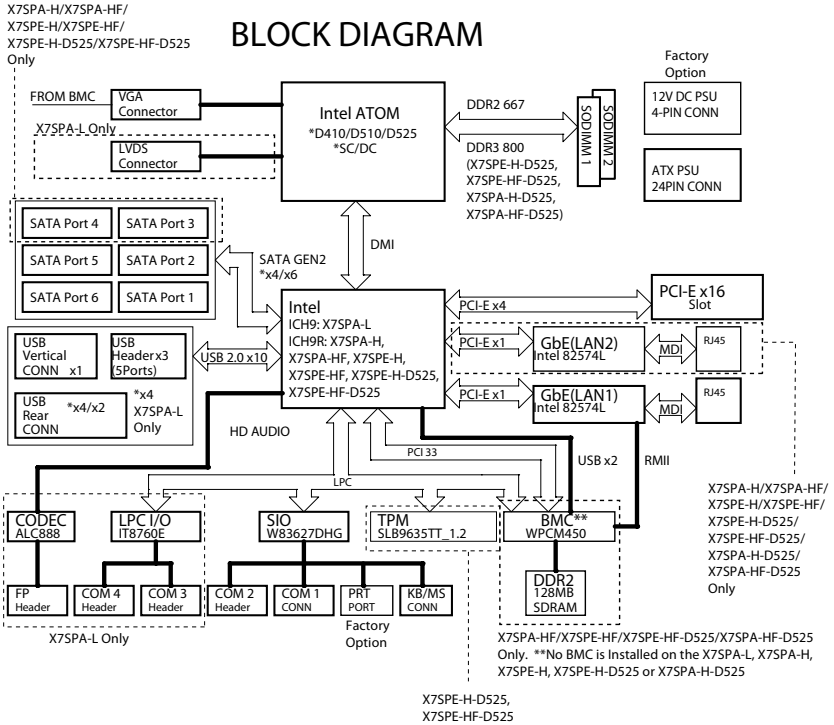

X7SPA/X7SPE Series Block Diagram



Note: This is a general block diagram. Please see the Motherboard Features pages for details on the features of the motherboard.

1-2 Chipset Overview

I/O Controller Hub: ICH9R (X7SPA-H/X7SPA-HF, X7SPE-H/ X7SPE-HF, X7SPE-H-D525, X7SPE-HF-D525, X7SPA- H-D525, X7SPA-HF-D525)

The I/O Controller ICH9R provides the data buffering and interface arbitration required for the system to operate efficiently. It also provides the bandwidth needed for the system to maintain its peak performance. The Direct Media Interface (DMI) provides the connection between the MCH and the ICH9R. The ICH9R supports up to six PCI-Express lanes, six Serial ATA (SATA) ports and twelve USB 2.0 ports. In addition, the ICH9R offers the Intel Matrix Storage Technology which provides various RAID options for data protection and rapid data access. It also supports the next generation of client management through the use of PROActive technology in conjunction with Intel's next generation Gigabit Ethernet controller.

Intel ICH9R System Features

The I/O Controller Hub provides the I/O subsystem with access to the rest of the system. Functions and capabilities include:

- Advanced Power Management
- SMBus 2.0 (I²C)
- SST/PECI Fan Speed Control
- SPI Flash
- Low Pin Count (LPC) Interface

I/O Controller Hub: ICH9 (X7SPA-L)

The ICH9 I/O Controller offers all features of the ICH9R controller, however it will only support up to 4 Serial ATA, & no RAID feature.

1-3 PC Health Monitoring

This section describes the PC health monitoring features of the X7SPA and X7SPE series. The motherboard has an onboard System Hardware Monitor chip that supports PC health monitoring.

Recovery from AC Power Loss

BIOS provides a setting for you to determine how the system will respond when AC power is lost and then restored to the system. You can choose for the system to remain powered off (in which case you must hit the power switch to turn it back on) or for it to automatically return to a power on state. See the Power Lost Control setting in the BIOS chapter of this manual to change this setting. The default setting is **Last State**.

Onboard Voltage Monitoring

The onboard voltage monitor will scan the following voltages continuously: CPU Cores, Chipset Voltage, Memory Voltage (+1.8V), +3.3V, +3.3V standby, +5V, +12V, and Vbat. Once a voltage becomes unstable, it will give a warning or send an error message to the screen. The User can adjust the voltage thresholds to define the sensitivity of the voltage monitor by using SD III.

Fan Status Monitor with Software

The PC health monitor can check the RPM status of the cooling fans via Supero Doctor III.

CPU Overheat LED and Control

This feature is available when the user enables the CPU overheat warning function in the BIOS. This allows the user to define an overheat temperature. When this temperature reaches the pre-defined threshold, the CPU thermal trip feature will be activated and it will send a signal to the Speaker LED and, at the same time, the CPU speed will be decreased.

1-4 Power Configuration Settings

This section describes features of your motherboard that deal with power and power settings.

Slow Blinking LED for Suspend-State Indicator

When the CPU goes into a suspend state, the chassis power LED will start blinking to indicate that the CPU is in suspend mode. When the user presses any key, the CPU will wake up and the LED will automatically stop blinking and remain on.

BIOS Support for USB Keyboard

If the USB keyboard is the only keyboard in the system, it will function like a normal keyboard during system boot-up.

Main Switch Override Mechanism

When an ATX power supply is used, the power button can function as a system suspend button. When the user presses the power button, the system will enter a SoftOff state. The monitor will be suspended and the hard drive will spin down. Pressing the power button again will cause the whole system to wake up. During the SoftOff state, the ATX power supply provides power to keep the required circuitry in the system "alive." In case the system malfunctions and you want to turn off the power, just press and hold the power button for 4 seconds. The power will turn off and no power will be provided to the motherboard.

1-5 Power Supply

As with all computer products, a stable power source is necessary for proper and reliable operation. It is even more important for processors that have high CPU clock rates of 1 GHz and faster.

The SUPER[®] X7SPA and X7SPE series accommodates 12V ATX power supplies. Although most power supplies generally meet the specifications required by the CPU, some are inadequate. A 2-Amp of current supply on a 5V Standby rail is strongly recommended.

1-6 Super I/O

The Super I/O provides two high-speed, 16550 compatible serial communication ports (UARTs). Each UART includes a 16-byte send/receive FIFO, a programmable baud rate generator, complete modem control capability and a processor interrupt system. Both UARTs provide legacy speed with baud rate of up to 115.2 Kbps as well as an advanced speed with baud rates of 250 K, 500 K, or 1 Mb/s, which support higher speed modems.

The Super I/O provides functions that comply with ACPI (Advanced Configuration and Power Interface), which includes support of legacy and ACPI power management through a SMI or SCI function pin. It also features auto power management to reduce power consumption.

1-7 Overview of the Nuvoton BMC Controller (X7SPA-HF/X7SPE-HF/X7SPE-HF-D525/X7SPA-HF-D525 only)

The NuvotonSM Baseboard Management Controller (BMC), supports the 2D/VGA-compatible Graphics Core with the PCI interface, Virtual Media, and Keyboard/Video/Mouse (KVM) Redirection modules.

The Nuvoton BMC interfaces with the host system via a PCI interface to communicate with the graphics core. It supports USB 2.0 and 1.1 for remote keyboard/mouse/virtual media emulation. It also provides LPC interface to control Super I/O functions and is connected to the network via an external Ethernet PHY module. It also communicates with onboard components via six SMBus interfaces, fan control, Platform Environment Control Interface (PECI) buses, and General Purpose I/O (T-SGPIO) ports.

The Nuvoton WPCM450 (Manufacturer P/N WPCM450RA0BX) has all the features as described above plus IPMI 2.0 support. This particular chip is installed in the X7SPA-HF/X7SPE-HF/X7SPE-HF-D525/X7SPA-HF-D525 motherboard model.



Note: For the X7SPA-HF/X7SPE-HF/X7SPE-HF-D525/X7SPA-HF-D525, IPMI is supported (shared) using LAN1. Please refer to the Embedded IPMI User's Guide posted on our website at <http://www.supermicro.com/support/manuals/>. You may also find information about IPMI by visiting Intel's website at <http://www.intel.com/design/servers/ipmi/>

1-8 LVDS (X7SPA-L only)

Low-Voltage Differential Signaling (LVDS) is an industry-standard electrical signaling system. This signaling system can run at very high speeds over inexpensive copper wires using low power.

The LVDS bus on the X7SPA-L motherboard is used to transport video data from the built-in graphics adapter to a computer monitor, such as a user-supplied external LCD display. This motherboard's 18-bpp LVDS connector (6 bits/color) is located on J5 and the inverter connector for the LCD/back light control is located on J6. It is possible for certain types of 24-bpp LCD panels (8 bits/color) to be connected to the 18-bpp interface. Please refer to the following illustration:

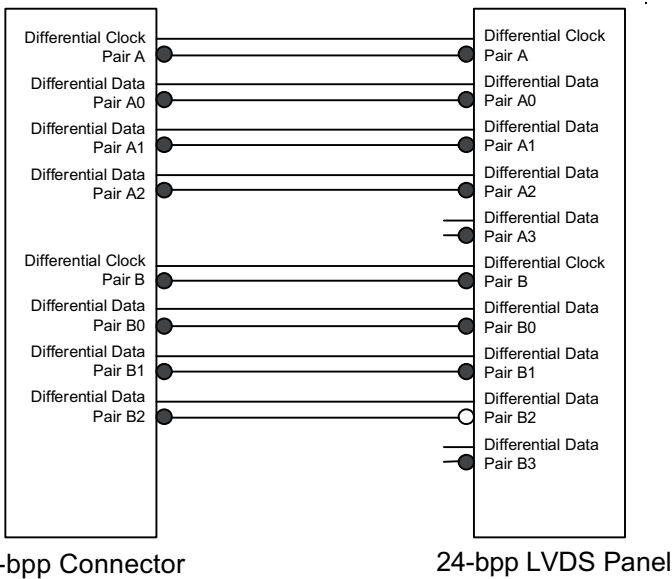

Note: The full 24-bpp range will not be available on the 24-bpp LVDS panel because the Differential Data Pair A3/B3 is not being driven by the 18-bpp connector. The LVDS panel will in effect operate as an 18-bpp device. For an in-depth explanation on this particular subject, go to www.intel.com and search for document 315975.pdf.

Chapter 2

Installation

2-1 Static-Sensitive Devices



Electrostatic-Discharge (ESD) can damage electronic components. To prevent damage to your system board, it is important to handle it very carefully. The following measures are generally sufficient to protect your equipment from ESD.



Precautions

- Use a grounded wrist strap designed to prevent static discharge.
- Touch a grounded metal object before removing the board from the antistatic bag.
- Handle the board by its edges only; do not touch its components, peripheral chips, memory modules or gold contacts.
- When handling chips or modules, avoid touching their pins.
- Put the motherboard and peripherals back into their antistatic bags when not in use.
- For grounding purposes, make sure your computer chassis provides excellent conductivity between the power supply, the case, the mounting fasteners and the motherboard.
- Use only the correct type of onboard CMOS battery. Do not install the onboard upside down battery to avoid possible explosion.

Unpacking

The motherboard is shipped in antistatic packaging to avoid static damage. When unpacking the board, make sure the person handling it is static protected.

2-2 Motherboard Installation

All motherboards have standard mounting holes to fit different types of chassis. Make sure that the locations of all the mounting holes for both motherboard and chassis match. Although a chassis may have both plastic and metal mounting fasteners, metal ones are highly recommended because they ground the motherboard to the chassis. Make sure that the metal standoffs click in or are screwed in tightly. Then use a screwdriver to secure the motherboard onto the motherboard tray.



Caution: Some components are very close to the mounting holes. Please take precautionary measures to prevent damage to these components when installing the motherboard to the chassis.

Tools Needed

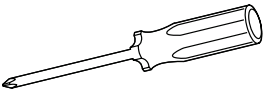

Phillips Screwdriver



Pan head screws (4-6 pieces)



Stand Offs (4-6 pieces)
(Only if needed)



Note: The above items are not provided with this motherboard.

Location of Mounting Holes

There are four (4) mounting holes on the X7SPA series, and six (6) on the X7SPE series motherboard.

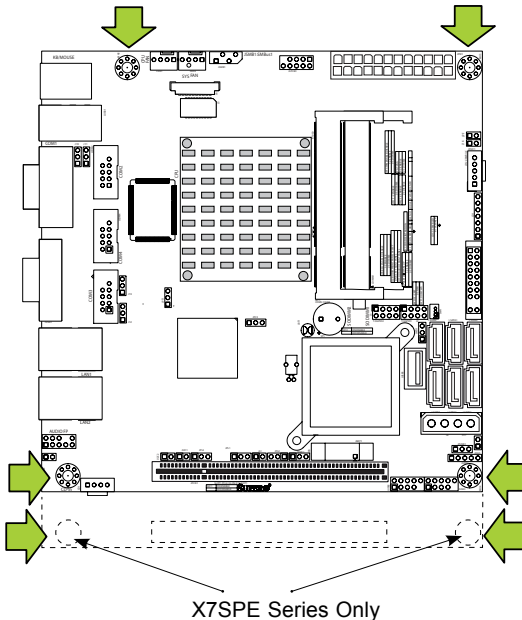



Caution: To avoid damaging the motherboard and its components, please do not use a force greater than 8 lb/inch on each mounting screw during motherboard installation.

Installation Instructions

1

Install the I/O shield into the chassis.

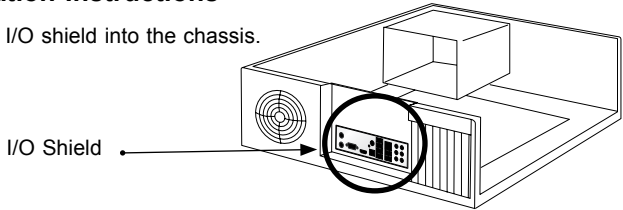

2

Locate the mounting holes on the motherboard. Refer to the layout on the previous page for mounting hole locations.

3

Locate the matching mounting holes on the chassis. Install standoffs in the chassis as needed. Align the mounting holes on the motherboard against the mounting holes on the chassis.

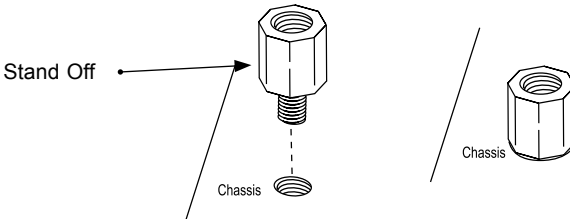

4

Install the motherboard into the chassis carefully to avoid damage to motherboard components.

5

Insert a Pan head #6 screw into a mounting hole on the motherboard and its matching mounting hole on the chassis, using the Philips screwdriver.

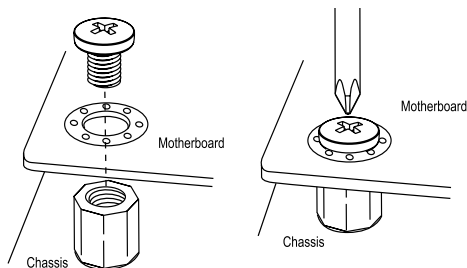

6

Repeat Step 4 to insert #6 screws to all mounting holes.

7

Make sure that the motherboard is securely placed on the chassis.

2-3 System Memory



CAUTION

Exercise extreme care when installing or removing DIMM modules to prevent any possible damage.



Note: Check the Supermicro website for a list of memory modules that have been validated with the X7SPA and X7SPE motherboard series.

How to Install SO DIMMs

1. Insert the desired number of SO DIMMs into the memory slots, starting with DIMM1, then DIMM2. Pay attention to the notch along the bottom of the module to prevent incorrect DIMM module installation.
2. Insert each DIMM module at an angle vertically and snap it into place. Repeat step 1 to install DIMM2 if needed. See instructions on the next page.

Memory Support

The X7SPA-L, X7SPA-H, X7SPA-HF, X7SPE-H and X7SPE-HF supports up to 4GB of unbuffered Non-ECC DDR2 SODIMMs (667/800 MHz in 2 SO DIMM slots) while the X7SPE-H-D525, X7SPA-H-D525, X7SPA-HF-D525 and X7SPE-HF-D525 supports up to 4GB of unbuffered Non-ECC DDR3 SODIMMs (800MHz in 2 SO DIMM slots).

Installing and Removing DIMMs

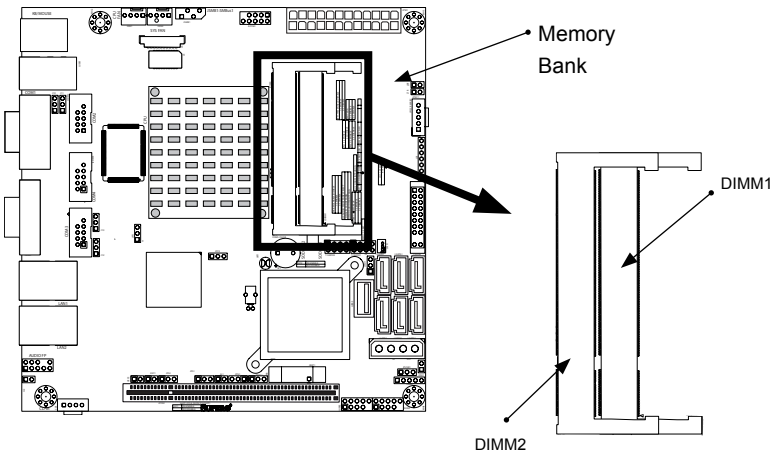

The SO DIMM Socket

- 1** Position the SO DIMM module's bottom key so it aligns with the receptive point on the slot.

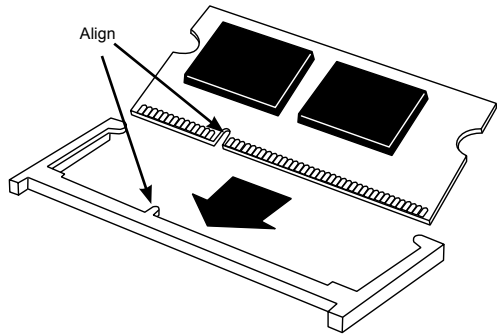

- 2** Insert the SO DIMM module vertically at about a 45 degree angle.

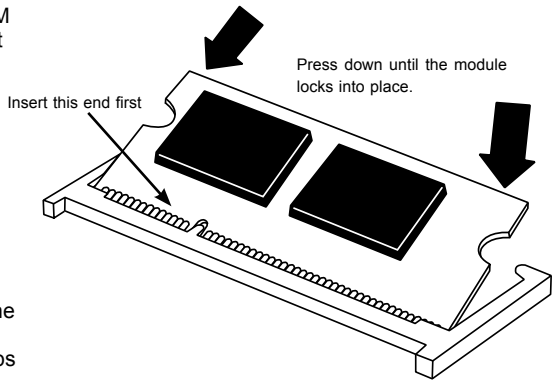

- 3** Press down until the module locks into place. The side clips will automatically secure the SO DIMM module, locking it into place.

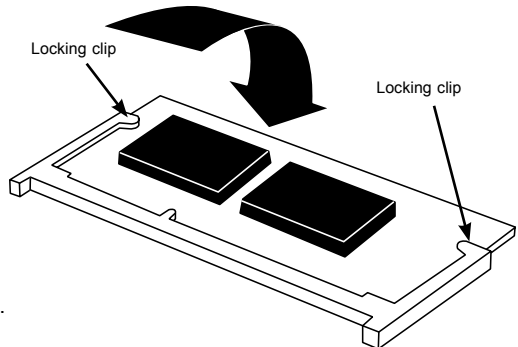

- 4** **To Remove:** Use your thumbs to gently push the side clips near both ends away from the module. This should release it from the slot. Pull the SO DIMM module upwards.

2-4 Connectors/I/O Ports

The I/O ports are color coded in conformance with the PC 99 specification. See the figure below for the colors and locations of the various I/O ports.

Back Panel Connectors and I/O Ports

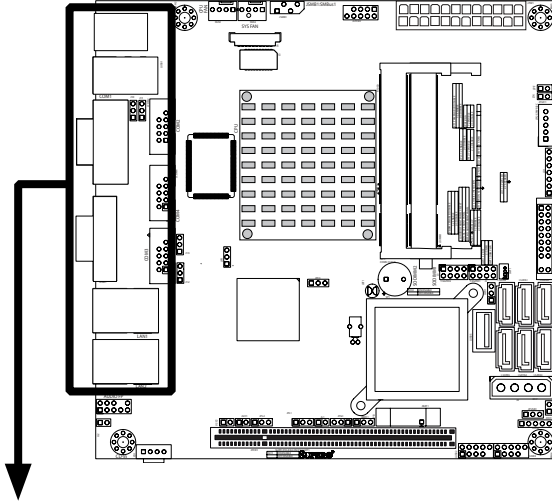

I/O Port Locations and Definitions

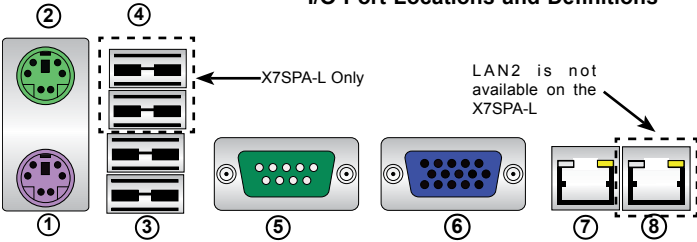

1. Keyboard (Purple)
2. PS/2 Mouse (Green)
3. USB Port 1/2
4. USB Port 3/4 (Supported on the X7SPA-L only)
5. COM 1 (Green)
6. VGA (Blue)
7. LAN1
8. LAN 2 (NOT supported on the X7SPA-L)

Back Panel Connectors

ATX PS/2 Keyboard and PS/2 Mouse Ports

The ATX PS/2 keyboard and PS/2 mouse are located next to the Back Panel USB Ports 0/1 on the motherboard. See the table at right for pin definitions.

PS/2 Keyboard/Mouse Pin Definitions			
PS2 Keyboard		PS2 Mouse	
Pin#	Definition	Pin#	Definition
1	KB Data	1	Mouse Data
2	No Connection	2	No Connection
3	Ground	3	Ground
4	Mouse/KB VCC (+5V)	4	Mouse/KB VCC (+5V)
5	KB Clock	5	Mouse Clock
6	No Connection	6	No Connection

VCC: with 1.5A PTC (current limit)

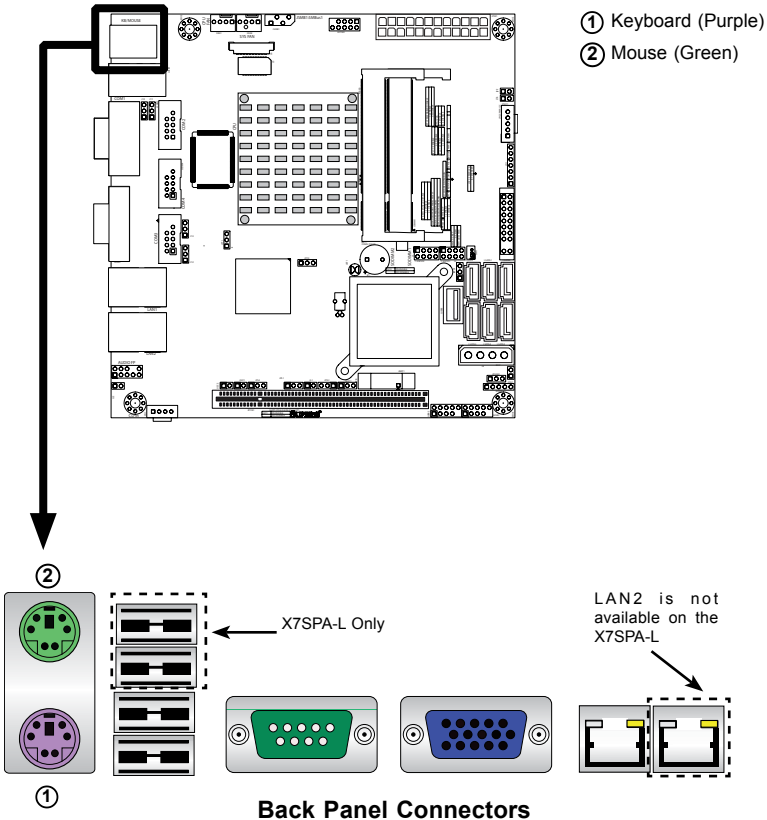

Universal Serial Bus (USB)

Four Universal Serial Bus ports (USB 1/2/3/4) are located on the I/O backpanel. Additionally, one Type A Internal USB port (USB 10) and five USB headers (USB 5/6, 7/8, 9) are also located on the motherboard to provide front chassis access. (Cables are not included). See the tables on the right for pin definitions.

 **Note:** USB 3/4 is available only on the X7SPA-L motherboard.

Back Panel USB 1/2/3/4, Type A USB 10 Pin Definitions			
Pin#	Definition	Pin#	Definition
1	+5V	5	+5V
2	USB_PN	6	USB_PN
3	USB_PP	7	USB_PP
4	Ground	8	Ground

Front Panel USB 5/6/7/8/9 Pin Definitions			
Pin #	Definition	Pin #	Definition
1	+5V	6	+5V
2	USB_PN	7	USB_PN
3	USB_PP	8	USB_PP
4	Ground	9	Ground
5	NA	10	Key

- ① Backpanel USB 1/2/3/4 (USB 3/4 is for the X7SPA-L only)
- ② USB 5/6 header
- ③ USB 7/8 header
- ④ USB 9 header
- ⑤ Internal USB 10 (Type A)

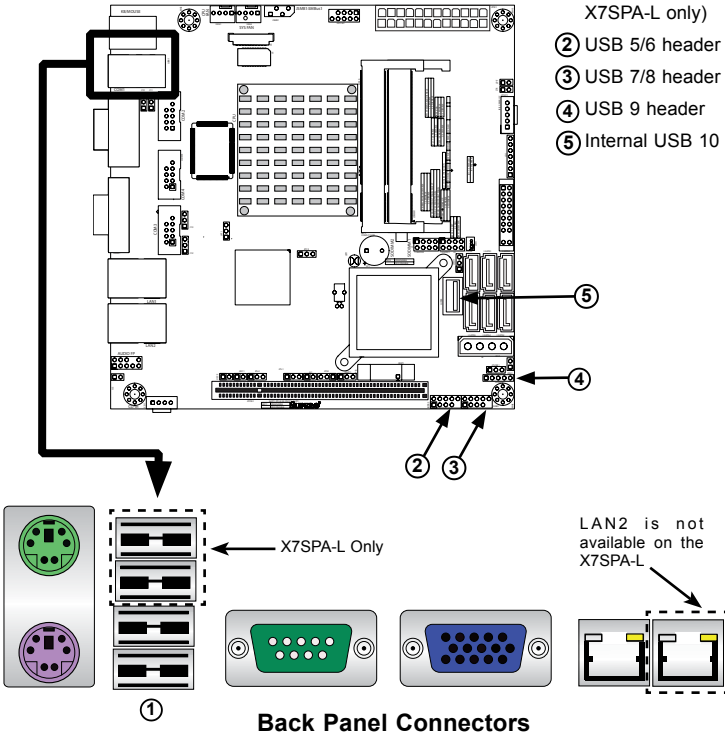

Serial Ports

Two COM connections (COM1, COM2) are located on the motherboard. COM1 is located on the back I/O panel. COM2 is located just behind the back panel connectors to provide additional on-board serial connection support. See the table on the right for pin definitions.

Serial Ports-COM1/COM2/COM3/COM4 Pin Definitions			
Pin #	Definition	Pin #	Definition
1	DCD	6	DSR
2	RXD	7	RTS
3	TXD	8	CTS
4	DTR	9	RI
5	Ground	10	N/A

 **Note:** Additional COM3 and COM4 headers are available on the X7SPA-L motherboard only.

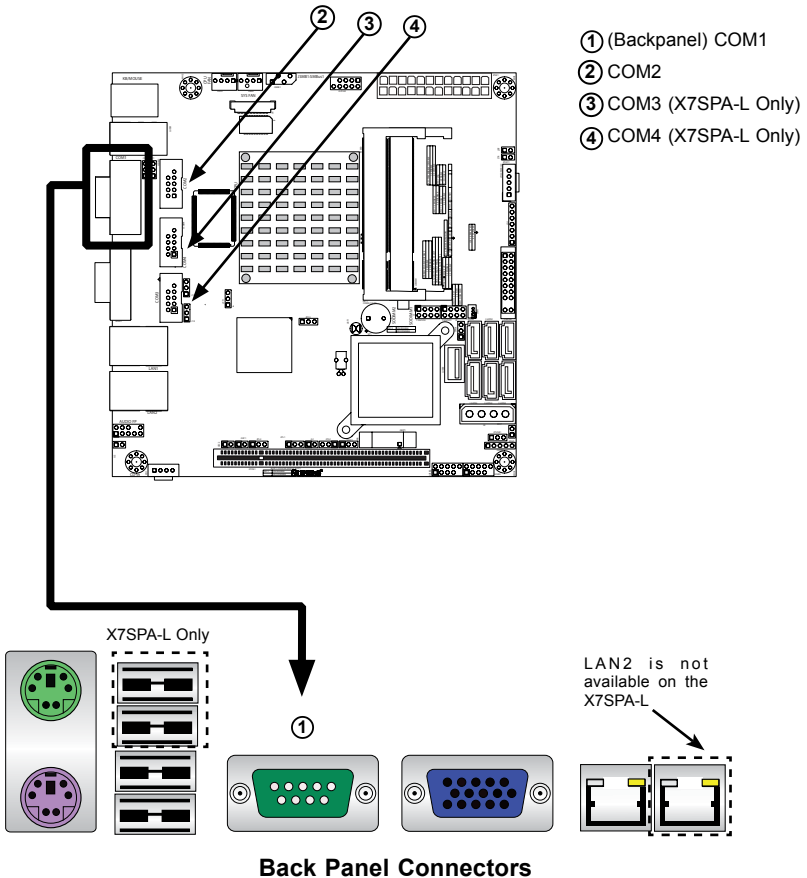

VGA Connector

A VGA connector is located next to the COM1 Port on the I/O back panel. This connector is used to provide video display. Refer to the board layout below for the location.

VGA Port/Connector Pin Definitions			
Pin #	Definition	Pin #	Definition
1	Red Video	9	+5V DC
2	Green Video	10	Ground (Vsync, DDC)
3	Blue Video	11	Reserved
4	Reserved	12	I ² C Data
5	Ground	13	H Sync
6	Red Return	14	V Sync
7	Green Return	15	I ² C Clock
8	Blue Return		

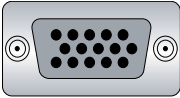

15-pin VGA Connector

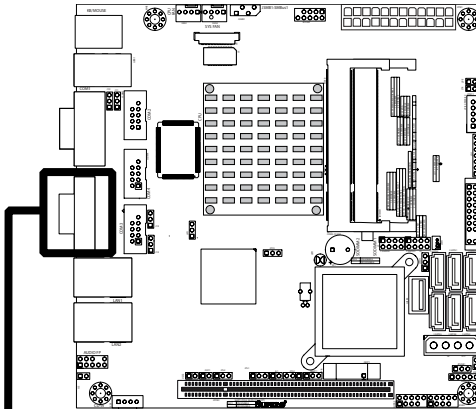

① VGA Port/Connector

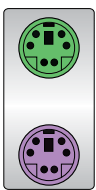

← X7SPA-L Only

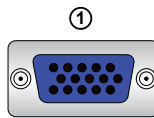
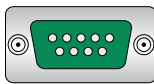

LAN2 is not available on the X7SPA-L

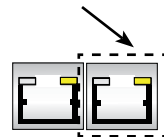

Back Panel Connectors

LAN Ports / IPMI

LAN ports are located on the I/O back panel. These ports accept RJ45 type cables. There are two Ethernet ports on the X7SPA-H, X7SPA-HF, X7SPE-H, X7SPE-HF, X7SPE-H-D525, X7SPE-HF-D525, X7SPA-H-D525, X7SPA-HF-D525 and one on the X7SPA-L motherboard

 **Note:** IPMI on the X7SPA-HF, X7SPE-HF, X7SPE-HF-D525, X7SPA-HF-D525 is supported through the same network connection as LAN1.

Note: Please refer to the LED Indicator Section for LAN LED information.

RJ45/LAN Pin Definitions			
Pin #	Definition	Pin #	Definition
1	TX_D1+	5	BI_D3-
2	TX_D1-	6	RX_D2-
3	RX_D2+	7	BI_D4+
4	BI_D3+	8	BI_D4-

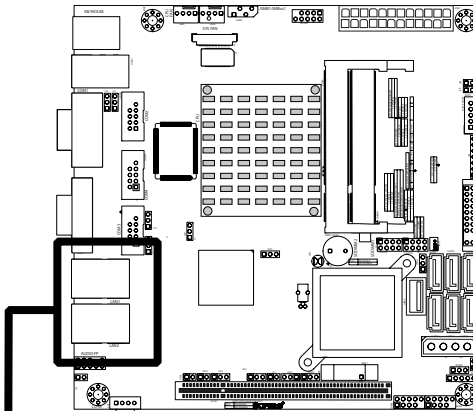
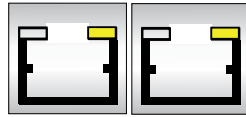

- ① LAN1 (Shared with IPMI on the X7SPA-HF, X7SPE-HF, X7SPA-HF-D525 and X7SPE-HF-D525)
- ② LAN2 (Not available on the X7SPA-L)

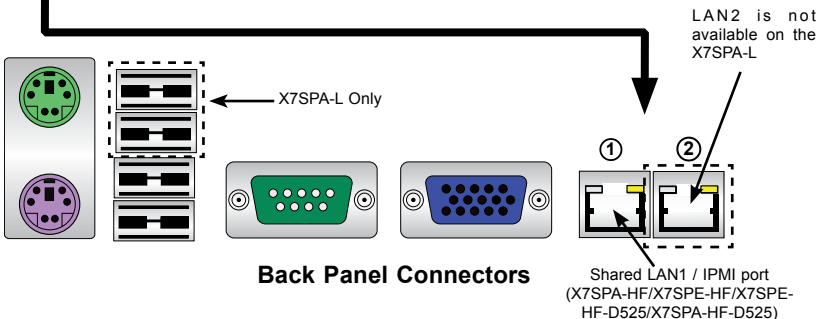

Front Control Panel

JF1 contains header pins for various buttons and indicators that are normally located on a control panel at the front of the chassis. These connectors are designed specifically for use with Supermicro server chassis. See the figure below for the descriptions of the various control panel buttons and LED indicators. Refer to the following section for descriptions and pin definitions.

JF1 Header Pins

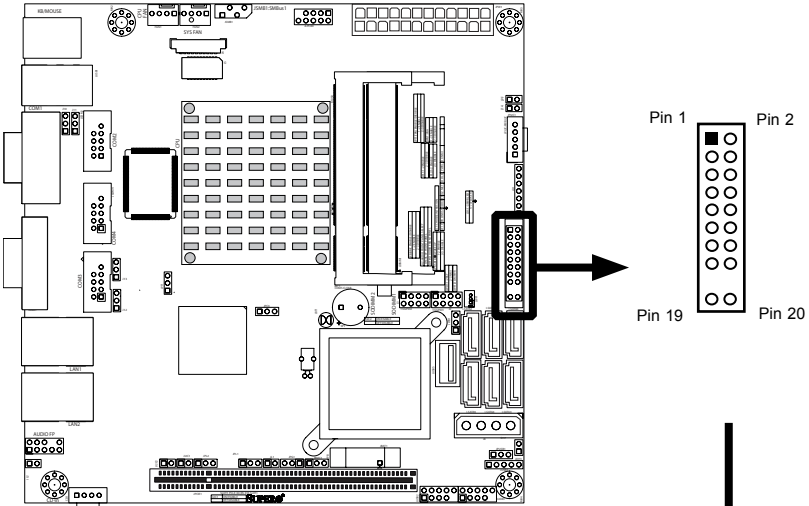

Power Button	○	○	Ground
Reset Button	○	○	Ground
Vcc	○	○	Power Fail LED
Vcc	○	○	OH/Fan Fail LED
Vcc	○	○	NIC2 LED
Vcc	○	○	NIC1 LED
Vcc	○	○	HDD LED
Vcc	○	○	Power LED
X	○	○	X
NMI	○	○	Ground

19 20

Front Control Panel Pin Definitions

Power LED

The Power LED connection is located on pins 15 and 16 of JF1. Refer to the table on the right for pin definitions.

Power LED Pin Definitions (JF1)	
Pin#	Definition
15	+3.3V
16	Ground

HDD LED

The HDD LED connection is located on pins 13 and 14 of JF1. Attach a hard drive LED cable here to display disk activity (for any hard drive activities on the system, including Serial ATA and IDE). See the table on the right for pin definitions.

HDD LED Pin Definitions (JF1)	
Pin#	Definition
13	+3.3V
14	HD Active

NIC1/NIC2 LED Indicators

The NIC (Network Interface Controller or Ethernet Controller) LED connection for LAN port 1 is located on pins 11 and 12 of JF1, and the LED connection for LAN Port 2 is on Pins 9 and 10. Attach the NIC LED cables to display network activity. Refer to the table on the right for pin definitions.

NIC 1/2 LED Pin Definitions (JF1)	
Pin#	Definition
11/9	Vcc
12/10	Ground

- A** POWER LED
- B** HDD LED
- C** NIC1
- D** NIC2

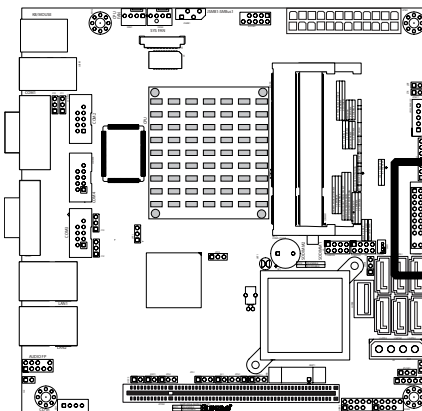

	1	2	
Power Button	○	○	Ground
Reset Button	○	○	Ground
Vcc	○	○	Power Fail LED
Vcc	○	○	OH/Fan Fail LED
Vcc	○	○	NIC2 LED D
Vcc	○	○	NIC1 LED C
Vcc	○	○	HDD LED B
Vcc	○	○	Power LED A
X	○	○	X
NMI	○	○	Ground

19 20

JF1 Header Pins

Overheat (OH)/Fan Fail LED

Connect an LED Cable to the OH/ Fan Fail connection on pins 7 and 8 of JF1 to provide advanced warnings of chassis overheat or fan failure. Refer to the table on the right for pin definitions.

OH/Fan Fail LED Pin Definitions (JF1)	
Pin#	Definition
7	Vcc
8	Ground

OH/Fan Fail Indicator Status	
State	Definition
Off	Normal
On	Overheat
Flashing	Fan Fail

Power Fail LED

The Power Fail LED connection is located on pins 5 and 6 of JF1. Refer to the table on the right for pin definitions.

PWR Fail LED Pin Definitions (JF1)	
Pin#	Definition
5	Vcc
6	Ground

- A** OH/Fan Fail LED
- B** Power Fail LED

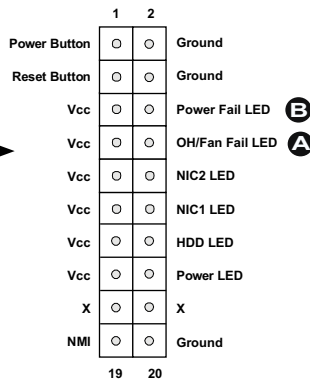
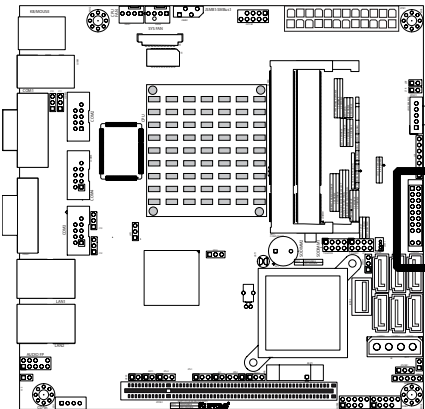

JF1 Header Pins

Reset Button

The Reset Button connection is located on pins 3 and 4 of JF1. Attach it to a hardware reset switch on the computer case. Refer to the table on the right for pin definitions.

Reset Button Pin Definitions (JF1)	
Pin#	Definition
3	Reset
4	Ground

Power Button

The Power Button connection is located on pins 1 and 2 of JF1. Momentarily contacting both pins will power on/off the system. To turn off the power when set to suspend mode, press the button for at least 4 seconds. Refer to the table on the right for pin definitions.

Power Button Pin Definitions (JF1)	
Pin#	Definition
1	Signal
2	Ground

NMI Button

The non-maskable interrupt button header is located on pins 19 and 20 of JF1. Refer to the table on the right for pin definitions.

NMI Button Pin Definitions (JF1)	
Pin#	Definition
1	Signal
2	Ground

- A** Reset Button
- B** PWR Button
- C** NMI Button

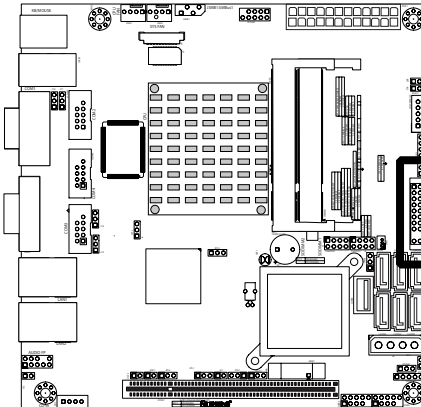

	1	2	
B Power Button	○	○	Ground
A Reset Button	○	○	Ground
Vcc	○	○	Power Fail LED
Vcc	○	○	OH/Fan Fail LED
Vcc	○	○	NIC2 LED
Vcc	○	○	NIC1 LED
Vcc	○	○	HDD LED
Vcc	○	○	Power LED
X	○	○	X
C NMI	○	○	Ground
	19	20	

JF1 Header Pins

2-5 Connecting Cables

This section provides brief descriptions and pin-out definitions for onboard power connectors. Be sure to use the correct cable for each header or connector.

ATX Main PWR & CPU PWR Connectors

The 24-pin main power connector (JPW1) is used to provide power to the motherboard. This connector meets the SSI EPS 12V specification. See the table on the right for pin definitions.

ATX Power 24-pin Connector Pin Definitions (JPW1)			
Pin#	Definition	Pin #	Definition
13	+3.3V	1	+3.3V
14	-12V	2	+3.3V
15	COM	3	COM
16	PS_ON	4	+5V
17	COM	5	COM
18	COM	6	+5V
19	COM	7	COM
20	Res (NC)	8	PWR_OK
21	+5V	9	5VSB
22	+5V	10	+12V
23	+5V	11	+12V
24	COM	12	+3.3V

(Required)

External Power Connector

In addition to the 24-pin main power connector and 4-pin CPU power connectors, the 4-pin External Power connector at J8 is used to provide power to external devices such as hard disks & CD-ROM drives. This power connector supports 12V and 5V devices.

4-Pin External Power Connector Pin Definitions

Pin	Definition
1	+12V
2	Ground 1
3	Ground 2
4	+5V

(Optional)

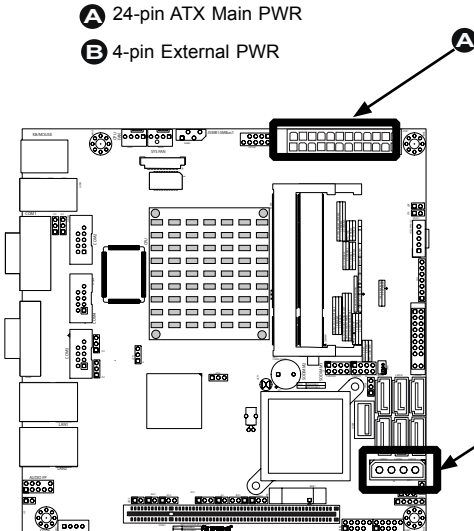

Do NOT connect the power supply to this connector. Its purpose is to supply power to devices such as CD drives, hard drives and similar devices, it's not meant to receive power from the power supply.

Fan Headers

The X7SPA and X7SPE series has two fan headers. Fan1 is the CPU fan and Fan2 is for the system cooling fan. These fans are 4-pin fan headers. However, Pins 1~3 of the fan headers are backward compatible with the traditional 3-pin fans. (**Note:** Please use all 3-pin fans or all 4-pin fans on a motherboard. Please do not use 3-pin fans and 4-pin fans on the same board. Refer to the table on the right for pin definitions.

Fan Header Pin Definitions	
Pin#	Definition
1	Ground
2	+12V
3	Tachometer
4	PWM_Control

A Fan1 (CPU)

B Fan2



Note: The speeds of 4-pin (PWM) fans are controlled by Thermal Management via BIOS Hardware Monitoring in the Advanced Setting. (The default setting is **Disabled**.)

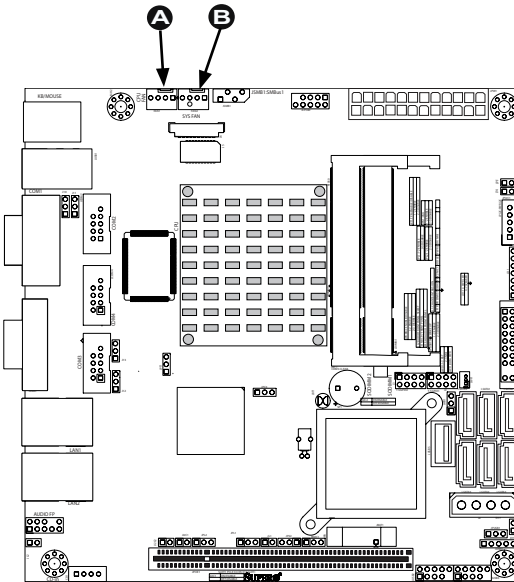

Overheat/Fan Fail LED (JOH)

The JOH header is used to connect an LED to provide warnings of chassis overheat. This LED will also blink to indicate a fan failure. Refer to the table on right for pin definitions.

Overheat LED Pin Definitions	
Pin#	Definition
1	5vDC
2	OH Active

OH/Fan Fail LED Status Message	
State	Message
Solid	Overheat
Blinking	Fan Fail

Front Panel Audio Header (X7SPA-L Only)

The Front Panel Audio header is used to connect the chassis' front panel High Definition Audio (HDA) controls to the motherboard. See the table on the right for pin definitions.

High Definition Front Panel Audio	
Pin#	Signal
1	MC_L
2	AUD_GND
3	MC_R
4	FP_Audio-Detect
5	Line_2_R
6	Ground
7	FP_Jack-Detect
8	Key
9	Line_2_L
10	Ground

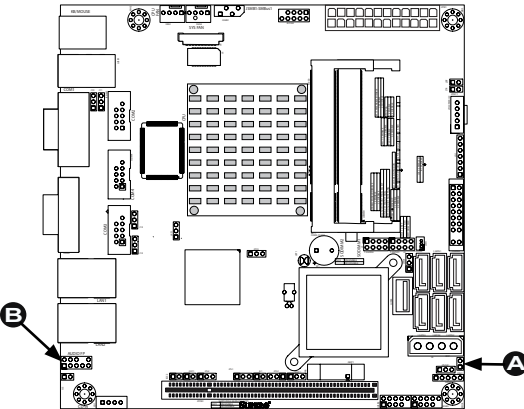

- A** OH/FF LED (JOH)
- B** Front Panel Audio (X7SPA-L Only)

Chassis Intrusion

A Chassis Intrusion header is located at JL1 on the motherboard. Attach the appropriate cable from the chassis to inform you of a chassis intrusion when the chassis is opened.

Chassis Intrusion Pin Definitions (JL1)	
Pin#	Definition
1	Intrusion Input
2	Ground

SATA DOM Power

The SATA DOM Power on JWF1 is used to supply power to SATA Disk-on-Module (DOM) solid-state storage devices.

PWR Supply I ² C Pin Definitions	
Pin#	Definition
1	Clock
2	Data
3	PWR Fail
4	Ground
5	+3.3V

Power SMB I²C Connector

Power System Management Bus (I²C) Connector monitors the status of the power supply, fan and system temperature. See the table on the right for pin definitions.

- A** Chassis Intrusion
- B** SATA DOM Power
- C** I2C Connector

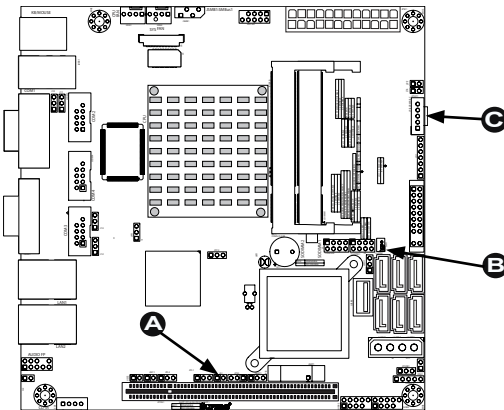

CD Header (X7SPA-L Only)

A 4-pin CD header located at CD1 is available on the X7SPA-L. This header allows you to use the onboard sound for audio CD playback. Connect an audio cable from your CD drive to the header that fits your cable's connector. See the table at right for pin definitions.

CD Header Pin Definitions	
Pin#	Definition
1	Left Stereo Signal
2	Ground
3	Ground
4	Right Stereo Signal

SMB

A System Management Bus (SMB) header is located at JSMB. Connect the appropriate cable here to use the SMB I²C connection on your system.

SMB Header Pin Definition	
Pin#	Definition
1	Data
2	Ground
3	Clock
4	No Connection

T-SGPIO 0/1 Headers

Two T-SGPIO (Serial-Link General Purpose Input/Output) headers are located near the SATA connectors on the motherboard. These headers are used to communicate with the enclosure management chip in the system. See the table on the right for pin definitions. Refer to the board layout below for the locations of the headers.

Serial_Link-SGPIO Pin Definitions			
Pin#	Definition	Pin	Definition
1	NC	2	NC
3	Ground	4	DATA Out
5	Load	6	Ground
7	Clock	8	NC

NC: No Connections

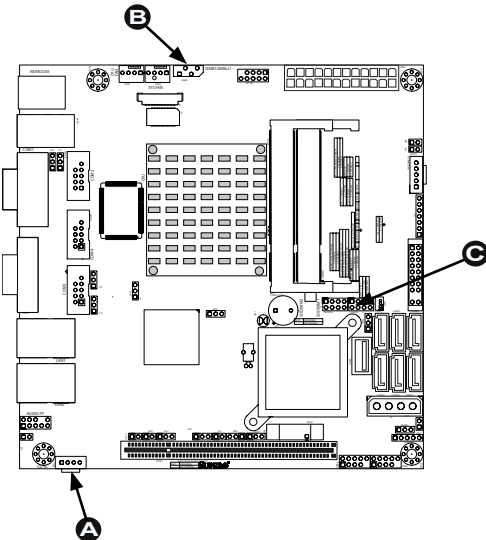

- A** CD Header
- B** SMB
- C** T-SGPIO Headers

LVDS Connector (X7SPA-L Only)

An LVDS connector (J5) is available on the X7SPA-L only. This connector provides 18-bit LVDS (Low Voltage Differential Signaling) for an LCD panel or other similar devices. Refer to the table on the right for pin definitions.

Inverter Power Connector (X7SPA-L Only)

The inverter connector on J6 is a 7-pin connector and is used in conjunction with the LVDS connector. Connect the backlight module of the LCD panel to this socket. This controls the backlight lamp, PWM control signals, and inverter power..

LVDS Pin Definitions			
Pin#	Definition	Pin	Definition
1	3.3V	11	3.3V
2	LDATAP0	12	LDATAN0
3	GND	13	GND
4	LDATAP1	14	LDATAN1
5	GND	15	GND
6	LDATAP2	16	LDATAN2
7	GND	17	GND
8	NC	18	NC
9	LVDDEN	19	NC
10	LCLKP	20	LCLKN

Inverter Power Pin Definitions	
Pin#	Definition
1	12V
2	12V
3	GND
4	GND
5	3.3V
6	3.3V
7	GND
8	GND
9	BKLTEN
10	BKLTCTL

- A** LVDS Connector
- B** Inverter Connector

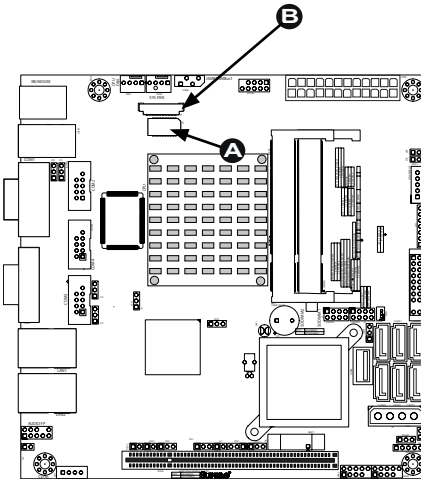

**TPM Header
(X7SPE-H-D525, X7SPE-HF-D525
Only)**

This header is used to connect a Trusted Platform Module (TPM), available from a third-party vendor. A TPM is a security device that allows encryption and authentication of hard drives. It enables the motherboard to deny access if the TPM associated with the hard drive is not installed in the system. See the table on the right for pin definitions.

Trusted Platform Module Header Pin Definitions			
Pin #	Definition	Pin #	Definition
1	LCLK	2	GND
3	LFRAME	4	No Pin
5	LRESET	6	VCC5
7	LAD3	8	LAD2
9	VCC3	10	LAD1
11	LAD0	12	GND
13	RSV0	14	RSV1
15	SB3V	16	SERIRQ
17	GND	18	CLKRUN
19	LPCPD	20	RSV2

A TPM Header

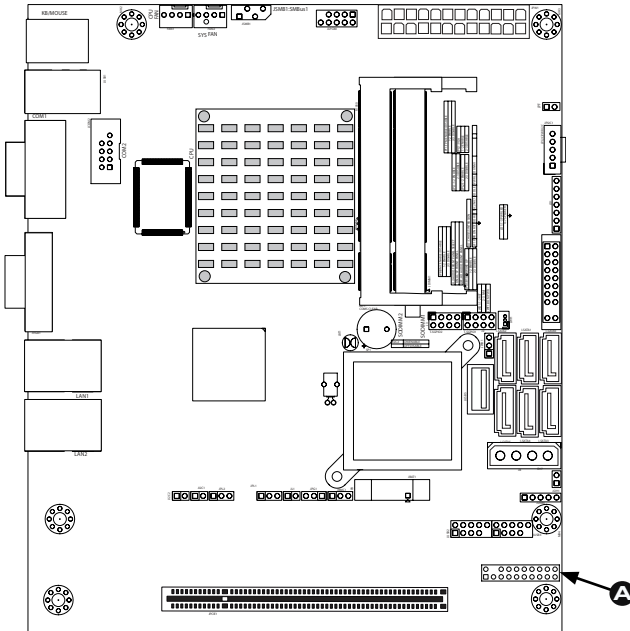

2-6 Jumper Settings

Explanation of Jumpers

To modify the operation of the motherboard, jumpers can be used to choose between optional settings. Jumpers create shorts between two pins to change the function of the connector. Pin 1 is identified with a square solder pad on the printed circuit board.



Note: On two pin jumpers, "Closed" means the jumper is on and "Open" means the jumper is off the pins.

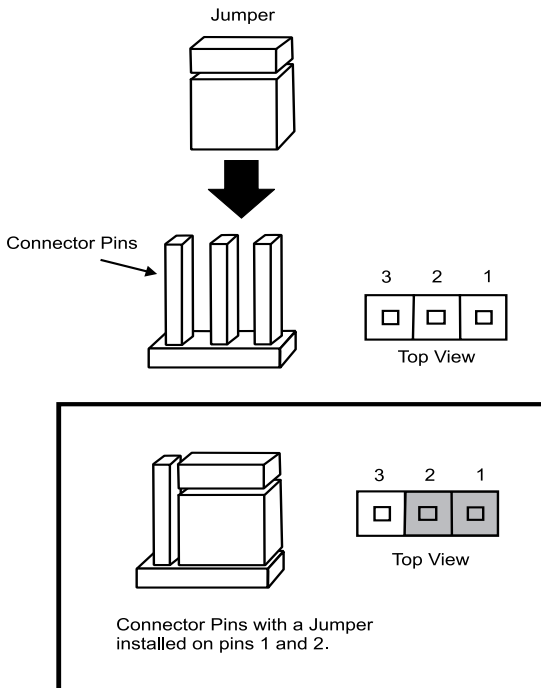

LAN Port Enable/Disable

JPL1/JPL2 enable or disable LAN Port 1/LAN Port 2 on the motherboard. See the table on the right for jumper settings. The default setting is enabled.

GLAN Enable Jumper Settings	
Pin#	Definition
1-2	Enabled (default)
2-3	Disabled

 **Note:** LAN Port 2 is not available on the X7SPA-L.

SMB (I²C) Bus to PCI Slots

Jumpers JI²C1 and JI²C2 allow you to connect the System Management Bus (SMB) to PCI-E and PCI slots. The default setting is set to **Disabled**. See the table on the right for jumper settings.

I ² C to PCI-Slots Jumper Settings	
Jumper	Definition
On	Enabled
Off	Disabled (Default)

- A** LAN Port 1 Enable
- B** LAN Port 2 Enable
(X7SPA-H, X7SPA-HF, X7SPE-HF, X7SPE-H, X7SPA-H-D525, X7SPA-HF-D525, X7SPE-H-D525, X7SPE-HF-D525 only)
- C** JI²C1/JI²C2

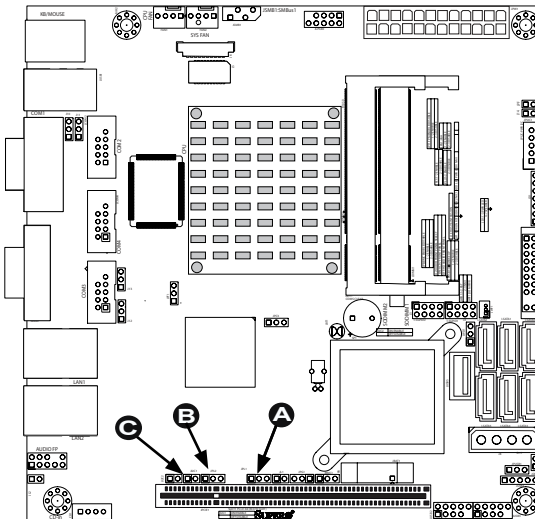

CMOS Clear

JBT1 is used to clear CMOS. Instead of pins, this "jumper" consists of contact pads to prevent accidental clearing of CMOS. To clear CMOS, use a metal object such as a small screwdriver to touch both pads at the same time to short the connection. Always remove the AC power cord from the system before clearing CMOS.



Important: For an ATX power supply, you must completely shut down the system, remove the AC power cord and then short JBT1 to clear CMOS.

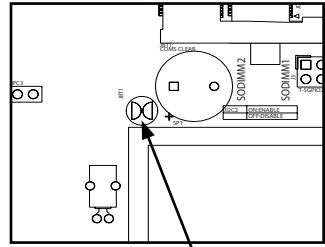

Motherboard



Metal contact pads

A CMOS Clear

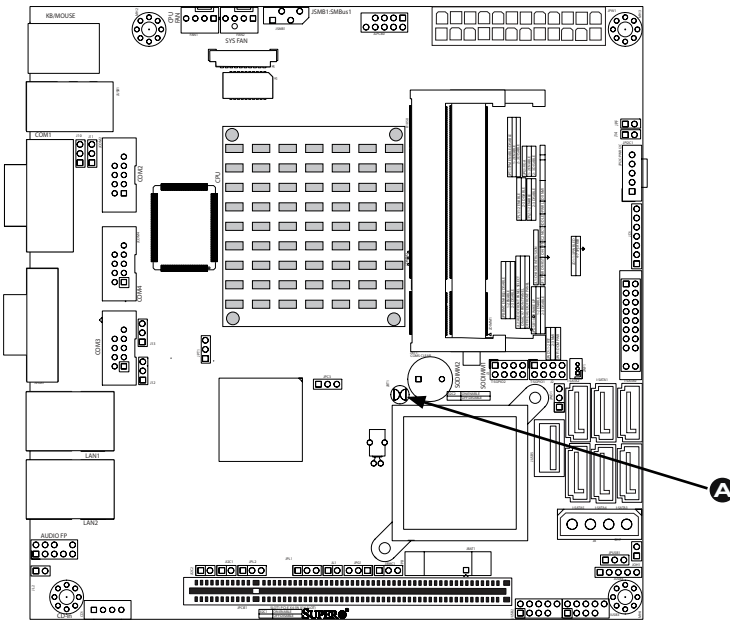

USB Wake-Up (Not Available on the X7SPE-H-D525, X7SPA-H-D525, X7SPA-HF-D525 and X7SPE-HF-D525)

Use JPUSB jumper to enable the function of "System Waking-Up via USB devices". This jumper allows you to "wake-up" the system by pressing a key on the USB keyboard or by clicking the USB mouse of your system. The JPUSB jumper is used together with the USB Wake-Up function in the BIOS. Enable both the jumper and the BIOS setting to activate this function. See the table on the right for jumper settings and jumper connections.

USB Wake-Up Jumper Settings	
Jumper Setting	Definition
Pins 1-2	Enabled
Pins 2-3	Disabled (Default)

A USB Wake-up

 **Note:** The default jumper setting is "Disabled". When the "USB Wake-Up" function is enabled, it will be active on all USB ports.

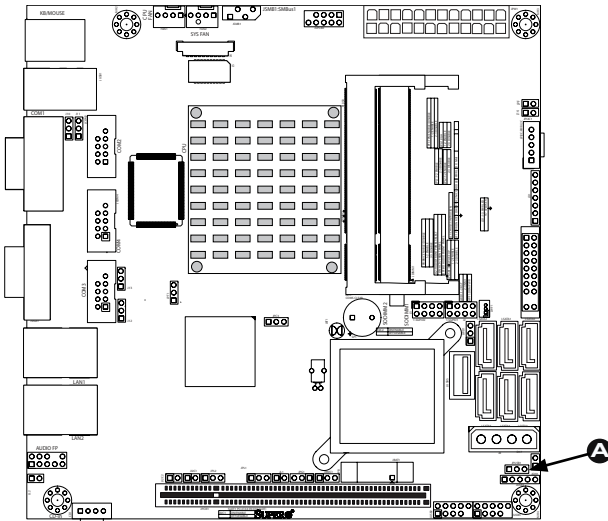

TPM Support Enable (Not available on X7SPA-H-D525, X7SPA-HF-D525, X7SPE-H-D525, X7SPE-HF-D525)

JPT1 allows the user to enable TPM (Trusted Platform Modules) support to enhance data integrity and system security. See the table on the right for jumper settings. The default setting is enabled.

TPM Support Enable Jumper Settings	
Jumper Setting	Definition
1-2	Enabled (Default)
2-3	Disabled

Watch Dog Enable/Disable

Watch Dog (JWD) is a system monitor that can reboot the system when a software application hangs. Close pins 1~2 to reset the system if an application hangs. Close pins 2~3 to generate a non-maskable interrupt signal for the application that hangs. See the table on the right for jumper settings. Watch Dog must also be enabled in the BIOS.

Watch Dog Jumper Settings (JWD)	
Jumper Setting	Definition
Pins 1-2	Reset (default)
Pins 2-3	NMI
Open	Disabled

COM3 Redirection Select (OEM Option)

This is an OEM option for the X7SPA-H, X7SPA-HF, X7SPE-H, X7SPE-HF, X7SPE-H-D525, X7SPA-H-D525, X7SPA-HF-D525 and X7SPE-HF-D525 only.

COM3 Select (JPC3)	
Jumper Setting	Definition
Pins 1-2	RS232 (default)
Pins 2-3	TTL
Open	Disabled

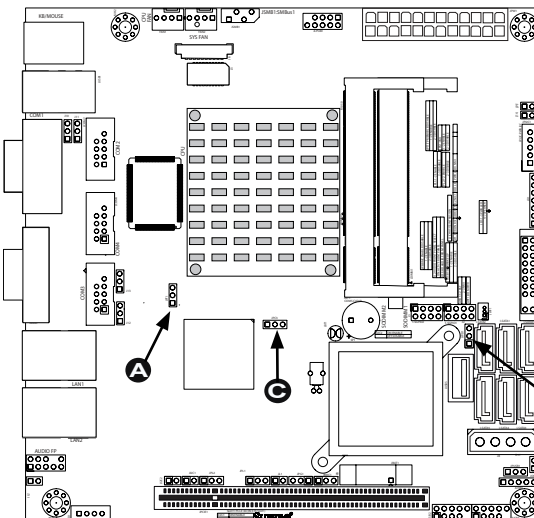

- A** TPM Enable
- B** Watch Dog Enable
- C** COM3 Redirect (OEM option for the X7SPA-H, X7SPA-HF, X7SPE-H, X7SPE-HF, X7SPA-H-D525, X7SPA-HF-D525, X7SPE-H-D525, and X7SPE-HF-D525 only).

Power LED/Speaker

On the JD1 header, pins 1~3 are used for a power LED and pins 4~7 are used for an external speaker. If you wish to use the onboard speaker, you should close pins 6-7 with a jumper. See the table on the right for speaker pin definitions.

Speaker Connector Pin Definitions	
Pin Setting	Definition
Pins 6-7	Internal Speaker
Pins 4-7	External Speaker

BMC (X7SPA-HF, X7SPE-HF, X7SPE-HF-D525, X7SPA-H-D525, X7SPA-HF-D525 Only)

The JPB jumper is used to enable or disable the on-board Baseboard Management Controller (BMC) and the on-board IPMI feature. This jumper is used together with the IPMI settings in the BIOS. The default position is pins 1 and 2 to enable BMC. See the table on the right for jumper settings.

BMC Pin Definitions	
Pin Setting	Definition
Pins 1-2	Enabled (Default)
Pins 2-3	Disabled

- A** Power LED/Speaker
- B** BMC Enable

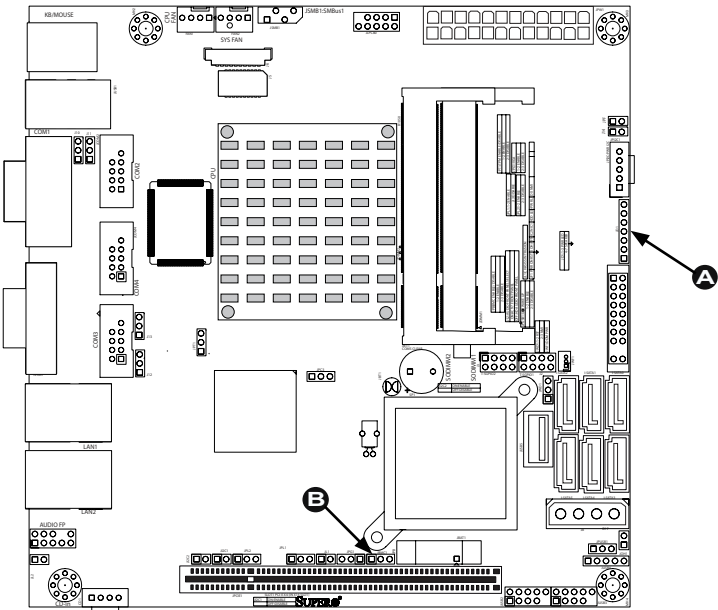

VGA Enable (X7SPA-HF, X7SPE-HF, X7SPE-HF-D525, X7SPA-HF-D525 only)

JPG1 allows the user to enable or disable the onboard VGA adapter on the X7SPA-HF, X7SPE-HF, X7SPA-HF-D525 and X7SPE-HF-D525. The default setting is Enabled.

VGA Enable Jumper Settings	
Pin#	Definition
1-2	Enabled (default)
2-3	Disabled

HDA/AC97 Select (X7SPA-L Only)

JL2 allows the user to select between High Definition Audio (HDA) or legacy AC97 audio. The default setting is HD Audio.

HDA/AC97 Jumper Settings	
Pin# 1-2	Definition
Open	HD Audio (default)
Closed	AC97

- A** VGA Enable
- B** HDA/AC97 Select

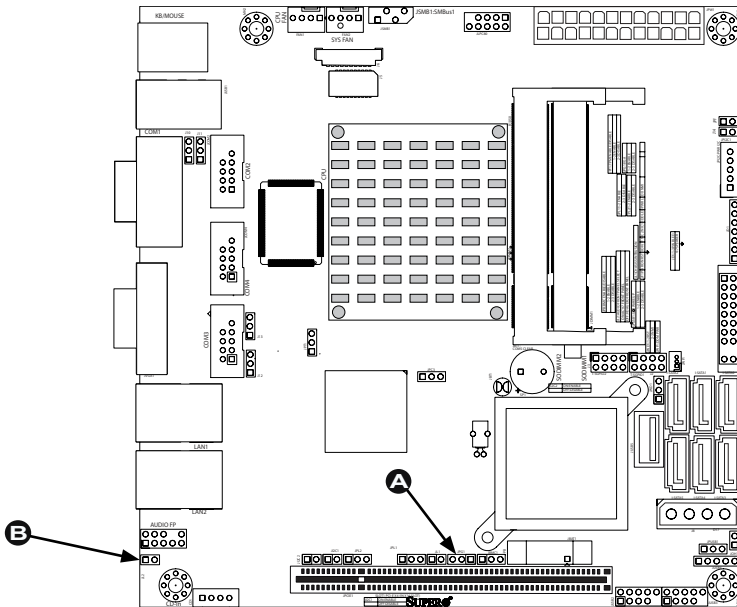

Power Force On Enable/Disable

Jumper JPF allows you to enable (force on) or disable the Power Force On function. If enabled, the power will always stay on automatically. If this function is disabled (the normal setting), the user needs to press the power button to power on the system.

Power Force On Enable/Disable Jumper Settings	
Jumper Setting	Definition
Open	Normal
Closed	Force On

DCD / P5V Select

This is an OEM option for the X7SPA-H, X7SPA-HF, X7SPE-H, X7SPE-HF, X7SPE-H-D525, X7SPE-HF-D525, X7SPA-H-D525, and X7SPA-HF-D525 only.

DCD / P5V Select Jumper Settings	
Jumper Setting	Definition
Pins 1-2	DCD
Pins 2-3	P5V

- A** Power Force On
- B** DCD / P5V Select (COM1)
- C** DCD / P5V Select (COM2)
- D** DCD / P5V Select (COM3)
- E** DCD / P5V Select (COM4)

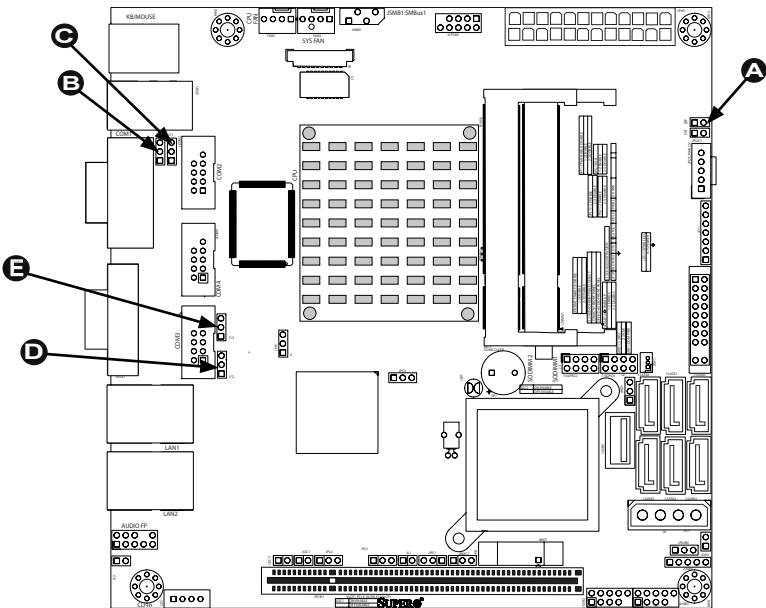

2-7 Onboard Indicators

LAN Port LEDs

Two LAN ports are located on the I/O Backplane. Each Ethernet LAN port has two LEDs. The yellow Activity LED (right, see below) indicates activity, while the Link/Speed LED (left) may be green, amber or off to indicate the speed of the connection. See the tables at right for more information.

GLAN Link/Speed LED Indicator	
LED Color	Definition
Off	No Connection or 10 Mbps
Green (On)	100 Mbps
Amber (On)	1 Gbps

GLAN Activity LED Indicator	
Color	Definition
Yellow (Flashing)	ConnectionActive

Link/Speed LED

Activity LED

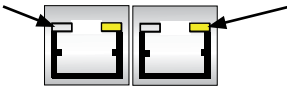

Rear View (when facing the rear side of the chassis)

- A** LAN Port 1
- B** LAN Port 2 (Not available on the X7SPA-L)

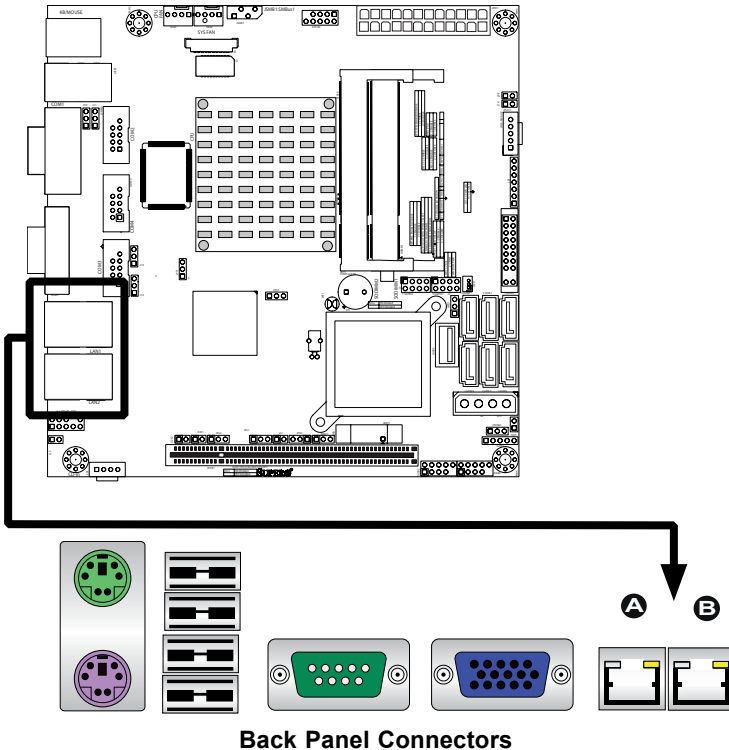

Back Panel Connectors

2-8 Serial ATA and HDD Connections

Note the following conditions when connecting the Serial ATA and hard disk drive cables:

- Be sure to use the correct cable for each connector. Refer to Page 1-1 for cables that came with your shipment.

SATA Connectors

Six (6) Serial ATA (SATA) connectors (I-SATA 0~5) are located on the motherboard, to provide serial link connections. Serial Link connections provide faster data transmission than those of the traditional Parallel ATA. These four SATA connectors are supported by the Intel ICH9/9R South Bridge. See the table on the right for pin definitions.

Note: There are Four (4) SATA ports on the X7SPA-L.

SATA Connectors Pin Definitions	
Pin#	Signal
1	Ground
2	SATA_TXP
3	SATA_TXN
4	Ground
5	SATA_RXN
6	SATA_RXP
7	Ground

- A** I-SATA0
- B** I-SATA1
- C** I-SATA2*
- D** I-SATA5*
- E** I-SATA4
- F** I-SATA3

*I-SATA2 and I-SATA3 are not available on the X7SPA-L.

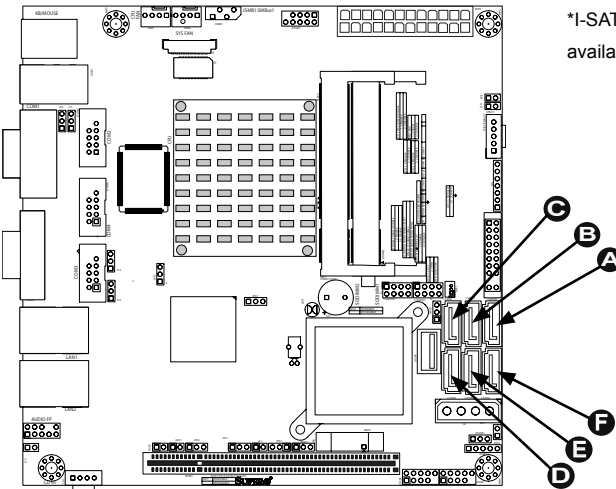

Chapter 3

Troubleshooting

3-1 Troubleshooting Procedures

Use the following procedures to troubleshoot your system. If you have followed all of the procedures below and still need assistance, refer to the 'Technical Support Procedures' and/or 'Returning Merchandise for Service' section(s) in this chapter. Always disconnect the AC power cord before adding, changing or installing any hardware components.

Before Power On

1. Be sure to unplug the power cable before installing or removing the components.)
2. Make sure that there are no short circuits between the motherboard and chassis.
3. Disconnect all ribbon/wire cables from the motherboard, including those for the keyboard and mouse. Also, be sure to remove all add-on cards.
4. Connect the chassis speaker and the power LED to the motherboard. Check all jumper settings as well.

No Power

1. Make sure that there are no short circuits between the motherboard and chassis.
2. Make sure that all jumpers are set to their default positions.
3. Check if the 115V/230V switch on the power supply is properly set.
4. Turn the power switch on and off to test the system.
5. The battery on your motherboard may be old. Check to make sure that it still supplies ~3VDC. If it does not, replace it with a new one.

No Video

1. If the power is on, but you have no video--in this case, you will need to remove all the add-on cards and cables first.

2. Use the speaker to determine if any beep codes exist. (Refer to Appendix A for details on beep codes.)
3. Remove all memory modules and turn on the system. (If the alarm is on, check the specs of memory modules, reset the memory or try a different one.)

Memory Errors

1. Make sure that the SO-DIMM modules are properly installed and fully seated in the slots.
2. Please check Section 2-3 and make sure that you are using the correct memory. Also, it is recommended that you use the memory modules of the same type and speed for all DIMMs in the system.
3. Check for bad DIMM modules or slots by swapping modules between slots to see if you can locate the faulty modules.
4. Check the power supply voltage 115V/230V switch.

Losing the System's Setup Configuration

1. Please be sure to use a high quality power supply. A poor quality power supply may cause the system to lose the CMOS setup information. Refer to Section 1-5 for details on recommended power supplies.
2. The battery on your motherboard may be old. Check to verify that it still supplies ~3VDC. If it does not, replace it with a new one.
3. If the above steps do not fix the Setup Configuration problem, contact your vendor for repairs.

3-2 Technical Support Procedures

Before contacting Technical Support, please make sure that you have followed all the steps listed below. Also, Note that as a motherboard manufacturer, Supermicro does not sell directly to end users, so it is best to first check with your distributor or reseller for troubleshooting services. They should know of any possible problem(s) with the specific system configuration that was sold to you.

1. Please go through the 'Troubleshooting Procedures' and 'Frequently Asked Question' (FAQ) sections in this chapter or see the FAQs on our website (<http://www.supermicro.com/support/faqs/>) before contacting Technical Support.
2. BIOS upgrades can be downloaded from our website at (<http://www.supermicro.com/support/bios/>).



Note: Not all BIOS can be flashed. Some cannot be flashed; it depends on the modifications to the boot block code.

3. If you've followed the instructions above to troubleshoot your system, and still cannot resolve the problem, then contact Supermicro's technical support and provide them with the following information:

- Motherboard model and PCB revision number
- BIOS release date/version (this can be seen on the initial display when your system first boots up)
- System configuration (OS version, peripheral devices, power supply type, etc)

An example of a Technical Support form is on our website at <http://www.supermicro.com/support/contact.cfm>.

4. Distributors: For immediate assistance, please have your account number ready when placing a call to our technical support department. We can be reached by e-mail at support@supermicro.com, by phone at: (408) 503-8000, option 2, or by fax at (408)503-8019.

3-3 Frequently Asked Questions

Question: What type of memory does my motherboard support?

Answer:

The X7SPA-L, X7SPA-H, X7SPA-HF, X7SPE-H, X7SPE-HF supports up to 4GB of **unbuffered** Non-ECC DDR2 667/800 MHz, two-way interleaved or non-interleaved SO DIMM SDRAM. See Section 2-4 for details on installing memory.

The X7SPE-H-D525, X7SPA-HF-D525, X7SPA-H-D525 and X7SPE-HF-D525 supports up to 4GB of **unbuffered** Non-ECC DDR3 800MHz, two-way interleaved or non-interleaved SO DIMM SDRAM

Question: Why does Microsoft Windows XP (SP2) and Windows Vista show less memory than what is physically installed?

Answer: Microsoft implemented a design change in Windows XP with Service Pack 2 (SP2) and Windows Vista. This change is specific to the Physical Address Extension (PAE) mode behavior which improves driver compatibility. For more information, please read the following article at Microsoft's Knowledge Base website at: <http://support.microsoft.com/kb/888137>.

Question: How do I update my BIOS?

Answer: It is recommended that you **do not** upgrade your BIOS if you are not experiencing any problems with your system. Updated BIOS files are located on our web site at <http://www.supermicro.com/support/bios/>. Please check our BIOS warning message and the information on how to update your BIOS on our web site. Select your motherboard model and download the BIOS (.rom) file to your computer. Also, check the current BIOS revision and make sure that it is newer than your BIOS before downloading. You may choose the zip file or the .exe file. If you choose the zipped BIOS file, please unzip the BIOS file onto a bootable device or a USB pen/thumb drive. To flash the BIOS, run the batch file named "ami.bat" with the new BIOS ROM file from your bootable device or USB pen/thumb drive. Use the following format:

```
F:\> ami.bat BIOS-ROM-filename.xxx <Enter>
```



Notes: Always use the file named "ami.bat" to update the BIOS and insert a space between "ami.bat" and the filename. The BIOS-ROM-filename will bear the motherboard name (i.e., X7SPA) and build version as the extension. For example, "X7SPA0.526".

When completed, your system will automatically reboot. If you choose the .exe file, please run the .exe file under Windows to create the BIOS flash floppy disk. Insert the floppy disk into the system you wish to flash the BIOS. Then, boot the system to the floppy disk. The BIOS utility will automatically flash the BIOS without any prompts. Please note that this process may take a few minutes to complete. Do not be concerned if the screen is paused for a few minutes.



Warning: Do not shut down or reset the system while updating the BIOS to prevent possible system boot failure!

When the BIOS flashing screen is completed, the system will reboot and will show "Press F1 or F2". At this point, you will need to load the BIOS defaults. Press <F1> to go to the BIOS setup screen, and press <F9> to load the default settings. Next, press <F10> to save and exit. The system will then reboot.



Note: The SPI BIOS chip installed on this motherboard is not removable. To repair or replace a damaged BIOS chip, please send your motherboard to RMA at Supermicro for service.

Question: What's on the CD that came with my motherboard?

Answer: The supplied compact disc has quite a few drivers and programs that will greatly enhance your system. We recommend that you review the CD and install the applications you need. Applications on the CD include chipset drivers for Windows, security and audio drivers.

3-4 Returning Merchandise for Service

A receipt or copy of your invoice marked with the date of purchase is required before any warranty service will be rendered. You can obtain service by calling your vendor for a Returned Merchandise Authorization (RMA) number. When returning to the manufacturer, the RMA number should be prominently displayed on the outside of the shipping carton, and mailed prepaid or hand-carried. Shipping and handling charges will be applied for all orders that must be mailed when service is complete.

This warranty only covers normal consumer use and does not cover damages incurred in shipping or from failure due to the alteration, misuse, abuse or improper maintenance of products.

During the warranty period, contact your distributor first for any product problems.

Notes

Chapter 4

BIOS

4-1 Introduction

This chapter describes the AMI BIOS Setup Utility for the X7SPA and X7SPE series. The AMI ROM BIOS is stored in a Flash EEPROM and can be easily updated. This chapter describes the basic navigation of the AMI BIOS Setup Utility setup screens.



Note: For instructions on BIOS recovery, please refer to the instruction guide posted at <http://www.supermicro.com/support/manuals/>.

Starting BIOS Setup Utility

To enter the AMI BIOS Setup Utility screens, press the <Delete> key while the system is booting up.



Note: In most cases, the <Delete> key is used to invoke the AMI BIOS setup screen. There are a few cases when other keys are used, such as <F1>, <F2>, etc.

Each main BIOS menu option is described in this manual. The Main BIOS setup menu screen has two main frames. The left frame displays all the options that can be configured. Grayed-out options cannot be configured. Options in blue can be configured by the user. The right frame displays the key legend. Above the key legend is an area reserved for a text message. When an option is selected in the left frame, it is highlighted in white. Often a text message will accompany it. (**Note:** the AMI BIOS has default text messages built in. Supermicro retains the option to include, omit, or change any of these text messages.)

The AMI BIOS Setup Utility uses a key-based navigation system called "hot keys". Most of the AMI BIOS setup utility "hot keys" can be used at any time during the setup navigation process. These keys include <F1>, <F10>, <Enter>, <ESC>, arrow keys, etc.



Note: Options printed in **Bold** are default settings.

How To Change the Configuration Data

The configuration data that determines the system parameters may be changed by entering the AMI BIOS Setup utility. This Setup utility can be accessed by pressing at the appropriate time during system boot.

How to Start the Setup Utility

Normally, the only visible Power-On Self-Test (POST) routine is the memory test. As the memory is being tested, press the <Delete> key to enter the main menu of the AMI BIOS Setup Utility. From the main menu, you can access the other setup screens. An AMI BIOS identification string is displayed at the left bottom corner of the screen, below the copyright message.



Warning! Do not upgrade the BIOS unless your system has a BIOS-related issue. Flashing the wrong BIOS can cause irreparable damage to the system. In no event shall Supermicro be liable for direct, indirect, special, incidental, or consequential damages arising from a BIOS update. If you have to update the BIOS, do not shut down or reset the system while the BIOS is updating. This is to avoid possible boot failure.

4-2 Main Setup

When you first enter the AMI BIOS Setup Utility, you will enter the Main setup screen. You can always return to the Main setup screen by selecting the Main tab on the top of the screen. The Main BIOS Setup screen is shown below.

BIOS SETUP UTILITY	
Main	Advanced Security Boot Exit
System Overview	
System Time	[11:10:59]
System Date	[Fri 12/04/2009]
Supermicro X7SPA-L/X7SPA-H/X7SPA-HF	
Version	:1.0
Build Date	:12/03/09
ID	:1060A000
Processor	
Intel(R) Atom(TM) CPU K510	@ 1.66GHz
Speed	:1666MHz
Physical Count	:1
Logical Count	:4
System Memory	
Populated Size	:2048MB
Available Size	:2048MB
Use [ENTER], [TAB] or [SHIFT-TAB] to select a field. Use [+] or [-] to configure system Time.	
↔ Select Screen ↑↓ Select Item +- Change Field Tab Select Field F1 General Help F10 Save and Exit ESC Exit	
v02.67 (C) Copyright 1985-2009, American Megatrends, Inc.	

System Overview: The following BIOS information will be displayed:

System Time/System Date

Use this option to change the system time and date. Highlight *System Time* or *System Date* using the arrow keys. Enter new values through the keyboard. Press the <Tab> key or the arrow keys to move between fields. The date must be entered in Day MM/DD/YY format. The time is entered in HH:MM:SS format. (**Note:** The time is in the 24-hour format. For example, 5:30 P.M. appears as 17:30:00.)

Supermicro X7SPA-L/X7SPA-H/X7SPA-HF/X7SPE-H/X7SPE-HF/X7SPE-H-D525/
X7SPE-HF-D525/X7SPA-H-D525/X7SPA-HF-D525

Version

Build Date

Processor

The AMI BIOS will automatically display the status of processor as shown below:

Type of Processor

Speed

Physical Count

Logical Count

System Memory

This displays the size of memory available in the system:

Populated Size

Available Size

4-3 Advanced Setup Configurations

Use the arrow keys to select Boot Setup and hit <Enter> to access the submenu items:

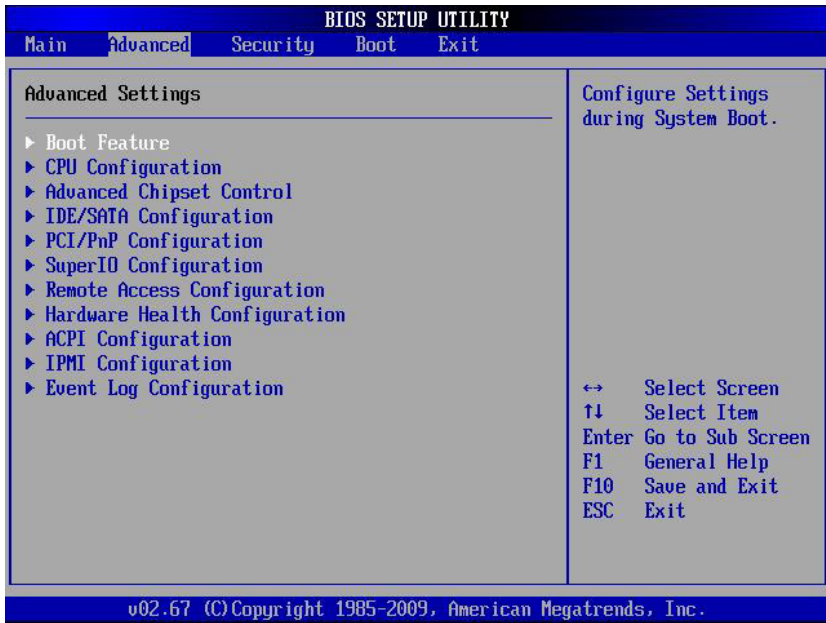

▶BOOT Feature

Quick Boot

If Enabled, this option will skip certain tests during POST to reduce the time needed for system boot. The options are **Enabled** and Disabled.

Quiet Boot

This option allows the bootup screen options to be modified between POST messages or the OEM logo. Select Disabled to display the POST messages. Select Enabled to display the OEM logo instead of the normal POST messages. The options are **Enabled** and Disabled.

AddOn ROM Display Mode

This sets the display mode for Option ROM. The options are **Force BIOS** and **Keep Current**.

Bootup Num-Lock

This feature selects the Power-on state for Numlock key. The options are Off and **On**.

PS/2 Mouse Support

This feature enables support for the PS/2 mouse. The options are Disabled, Enabled and **Auto**.

Wait For 'F1' If Error

This forces the system to wait until the 'F1' key is pressed if an error occurs. The options are Disabled and **Enabled**.

Hit 'Del' Message Display

This feature displays "Press DEL to run Setup" during POST. The options are **Enabled** and Disabled.

Watch Dog Function

If enabled, the Watch Dog Timer will allow the system to reboot when it is inactive for more than 5 minutes. The options are Enabled and **Disabled**.

Power Button Function

This setting allows you to decide if the power button will turn off the system instantly or wait for 4 seconds when it is pressed. The options are **Instant Off** and 4 Seconds Override.

Restore on AC Power Loss

Use this feature to set the power state after a power outage. Select Power-Off for the system power to remain off after a power loss. Select Power-On for the system power to be turned on after a power loss. Select Last State to allow the system to resume its last state before a power loss. The options are Power-On, Power-Off and **Last State**.

Interrupt 19 Capture

Interrupt 19 is the software interrupt that handles the boot disk function. When this item is set to Enabled, the ROM BIOS of the host adaptors will "capture" Interrupt 19 at boot and allow the drives that are attached to these host adaptors to function as bootable disks. If this item is set to Disabled, the ROM BIOS of the host adaptors will not capture Interrupt 19, and the drives attached to these adaptors will not function as bootable devices. The options are **Enabled** and Disabled.

Standby Power in S5

This feature supplies standby power while in S5 (sleep mode). Set this feature to Disabled to comply with EuP requirements, Enable this feature to activate wake-up capability while in sleep mode. The options are **Enabled** and Disabled.

►CPU Configuration

Warning: Take Caution when changing the Advanced settings. An incorrect value, a very high DRAM frequency or incorrect DRAM timing may cause system to become unstable. When this occurs, revert to the default setting.

Clock Spread Spectrum

Select Enable to use the feature of Clock Spectrum, which will allow the BIOS to monitor and attempt to reduce the level of Electromagnetic Interference caused by the components whenever needed. Select Disabled to enhance system stability. The options are **Disabled** and Enabled.

Max CPUID Value Limit

This feature allows the user to set the maximum CPU ID value. Enable this function to boot the legacy operating systems that cannot support processors with extended CPUID functions. The options are Enabled and **Disabled** (for the Windows OS.).

Execute-Disable Bit Capability (Available when supported by the OS and the CPU)

Set to Enabled to enable the Execute Disable Bit which will allow the processor to designate areas in the system memory where an application code can execute and where it cannot, thus preventing a worm or a virus from flooding illegal codes to overwhelm the processor or damage the system during an attack. The default is **Enabled**. (Refer to Intel and Microsoft Web Sites for more information.)

Hyper-threading Technology

This setting allows you to **Enable** or Disable hyper-threading in the CPU. Enabling hyper-threading results in increased CPU performance.

►Advanced Chipset Control

The items included in the Advanced Settings submenu are listed below.

►Northbridge Configuration

DRAM Frequency

This option allows the user to select the desired frequency setting for the onboard memory modules. The options are **Auto**, 667 MHz and 800 MHz. (667 MHz is not available on the X7SPE-H-D525, X7SPA-HF-D525 and X7SPE-HF-D525).

Configure DRAM Timing by SPD

This option allows the user to select the desired DRAM timing for the onboard memory modules. The options are **Enabled** and Disabled. The following will appear when Disabled is selected:

DRAM CAS# Latency

The options are [3], [4], [**5**], and [6]

DRAM RAS# to CAS# Delay

The options are 3 DRAM Clocks, 4 DRAM Clocks, 5 DRAM Clocks, and **6 DRAM Clocks**.

DRAM RAS# Precharge

The options are 3 DRAM Clocks, 4 DRAM Clocks, 5 DRAM Clocks, and **6 DRAM Clocks**.

DRAM RAS# Activate to Precharge

The options are 9 DRAM Clocks, 10 DRAM Clocks, 11 DRAM Clocks, 12 DRAM Clocks, 13 DRAM Clocks, 14 DRAM Clocks, and **15 DRAM Clocks**.

Initiate Graphics Adapter

This option selects which graphics adapter to use as a primary boot device. The options are Other, **Onboard VGA** and Slot6.

Internal Graphics Mode Select

This option selects the amount of system memory used by the onboard graphics adapter. The options are **Enabled**, **8MB**.

►Video Function Configuration (X7SPA-L, X7SPE-H, X7SPA-H-D525 and X7SPE-H-D525 only)

DVMT Mode Select

Select DVMT Mode to enable Dynamic Video Memory Technology (DVMT). The options are Fixed Mode and **DVMT Mode**.

DVMT/Fixed Memory

This item selects the DVMT/Fixed memory size. The options are 128MB, **256MB** and Maximum DVMT.

Boot Display Device

This item selects the display device the motherboard uses during system boot. The options are CRT, LVDS and **CRT + LVDS**.

Alternate Video BIOS

This item selects the display BIOS used by the motherboard. The options are **Auto**, Standard and Customize.

Active State Power Management

Select Enabled to start Active-State Power Management for signal transactions between L0 and L1 Links on the PCI Express Bus. This maximizes power-saving and transaction speed. The options are Enabled and **Disabled**.

Reserved Page Route

This feature allows the user to decide which bus to send debug information to. The options are Disabled, PCI and **LPC**.

USB Functions

This feature allows the user to decide the number of onboard USB ports to be enabled. The Options are: Disabled, 2 USB ports, 4 USB ports, 6 USB ports, 8 USB ports, 10 USB ports, and **12 USB ports**.

Legacy USB Support (available if USB Functions above is Enabled)

Select Enabled to use Legacy USB devices. If this item is set to Auto, Legacy USB support will be automatically enabled if a legacy USB device is installed

on the motherboard, and vice versa. The settings are Disabled, Enabled and **Auto**.

USB Controller

This feature allows the user to Enable or Disable the onboard USB controller. The options are **Enabled** and Disabled. Note: This function is grayed-out if USB Functions above is set to Enabled.

►IDE/SATA Configuration

When this submenu is selected, the AMI BIOS automatically detects the presence of the IDE Devices and displays the following items:

SATA#1 Configuration

If Compatible is selected, it sets SATA#1 to legacy compatibility mode, while selecting Enhanced sets SATA#1 to native SATA mode. The options are Disabled, Compatible, **Enhanced**.

Configure SATA#1 as

This feature allows the user to select the drive type for SATA#1. The options are **IDE**, RAID and AHCI.

SATA#2 Configuration (Available if IDE is enabled under "Configure SATA#1 as" above)

Selecting Enhanced will set SATA#2 to native SATA mode. The options are Disabled and **Enhanced**

IDE Detect Timeout (sec)

Use this feature to set the time-out value for the BIOS to detect the ATA, ATAPI devices installed in the system. The options are 0 (sec), 5, 10, 15, 20, 25, 30, and **35**.

Primary IDE Master/Slave, Secondary IDE Master/Slave, Third IDE Master, Fourth IDE Master

These settings allow the user to set the parameters of the disc storage devices attached to the SATA ports. Press <Enter> to activate the following submenu screen for detailed options of these items. Set the correct configurations accordingly. The items included in the submenu are:

Type

Select the type of device connected to the system. The options are Not Installed, **Auto**, CD/DVD and ARMD.

LBA/Large Mode

LBA (Logical Block Addressing) is a method of addressing data on a disk drive. In the LBA mode, the maximum drive capacity is 137 GB. For drive capacities over 137 GB, your system must be equipped with a 48-bit LBA mode addressing. If not, contact your manufacturer or install an ATA/133 IDE controller card that supports 48-bit LBA mode. The options are Disabled and **Auto**.

Block (Multi-Sector Transfer)

Block Mode boosts the IDE drive performance by increasing the amount of data transferred. Only 512 bytes of data can be transferred per interrupt if Block Mode is not used. Block Mode allows transfers of up to 64 KB per interrupt. Select Disabled to allow data to be transferred from and to the device one sector at a time. Select Auto to allow data transfer from and to the device occur multiple sectors at a time if the device supports it. The options are **Auto** and Disabled.

PIO Mode

The IDE PIO (Programmable I/O) Mode programs timing cycles between the IDE drive and the programmable IDE controller. As the PIO mode increases, the cycle time decreases. The options are **Auto**, 0, 1, 2, 3, and 4.

Select Auto to allow the AMI BIOS to automatically detect the PIO mode. Use this value if the IDE disk drive support cannot be determined.

Select 0 to allow the AMI BIOS to use PIO mode 0. It has a data transfer rate of 3.3 MBs.

Select 1 to allow the AMI BIOS to use PIO mode 1. It has a data transfer rate of 5.2 MBs.

Select 2 to allow the AMI BIOS to use PIO mode 2. It has a data transfer rate of 8.3 MBs.

Select 3 to allow the AMI BIOS to use PIO mode 3. It has a data transfer rate of 11.1 MBs.

Select 4 to allow the AMI BIOS to use PIO mode 4. It has a data transfer bandwidth of 32-Bits. Select Enabled to enable 32-Bit data transfer.

DMA Mode

Select Auto to allow the BIOS to automatically detect IDE DMA mode when the IDE disk drive support cannot be determined.

Select SWDMA0 to allow the BIOS to use Single Word DMA mode 0. It has a data transfer rate of 2.1 MBs.

Select SWDMA1 to allow the BIOS to use Single Word DMA mode 1. It has a data transfer rate of 4.2 MBs.

Select SWDMA2 to allow the BIOS to use Single Word DMA mode 2. It has a data transfer rate of 8.3 MBs.

Select MWDMA0 to allow the BIOS to use Multi Word DMA mode 0. It has a data transfer rate of 4.2 MBs.

Select MWDMA1 to allow the BIOS to use Multi Word DMA mode 1. It has a data transfer rate of 13.3 MBs.

Select MWDMA2 to allow the BIOS to use Multi-Word DMA mode 2. It has a data transfer rate of 16.6 MBs.

Select UDMA0 to allow the BIOS to use Ultra DMA mode 0. It has a data transfer rate of 16.6 MBs. It has the same transfer rate as PIO mode 4 and Multi Word DMA mode 2.

Select UDMA1 to allow the BIOS to use Ultra DMA mode 1. It has a data transfer rate of 25 MBs.

Select UDMA2 to allow the BIOS to use Ultra DMA mode 2. It has a data transfer rate of 33.3 MBs.

Select UDMA3 to allow the BIOS to use Ultra DMA mode 3. It has a data transfer rate of 66.6 MBs.

Select UDMA4 to allow the BIOS to use Ultra DMA mode 4 . It has a data transfer rate of 100 MBs.

The options are **Auto**, SWDMA_n, MWDMA_n, and UDMA_n.

S.M.A.R.T. For Hard disk drives

Self-Monitoring Analysis and Reporting Technology (SMART) can help predict impending drive failures. Select Auto to allow the AMI BIOS to automatically detect hard disk drive support. Select Disabled to prevent the AMI BIOS from using the S.M.A.R.T. Select Enabled to allow the AMI BIOS to use the S.M.A.R.T. to support hard drive disk. The options are Disabled, Enabled, and **Auto**.

32-Bit Data Transfer

Select Enable to enable the function of 32-bit IDE data transfer. The options are **Enabled** and Disabled.

►PCI/PnP Configuration

This feature allows the user to set the PCI/PnP configurations for the following items:

Clear NVRAM

This feature clears the NVRAM during system boot. The options are **No** and Yes.

Plug & Play OS

Selecting Yes allows the OS to configure Plug & Play devices. (This is not required for system boot if your system has an OS that supports Plug & Play.) Select **No** to allow the AMI BIOS to configure all devices in the system.

PCI Latency Timer

This feature sets the latency Timer of each PCI device installed on a PCI bus. Select 64 to set the PCI latency to 64 PCI clock cycles. The options are 32, **64**, 96, 128, 160, 192, 224 and 248.

PCI IDE Bus Master

When enabled, the BIOS uses PCI bus mastering for reading/writing to IDE drives. The options are Disabled and **Enabled**.

ROM Scan Ordering

This item determines what kind of option ROM activates over another. The options are **Onboard First** and Add-on First.

PCI Slot 1

Use this feature to enable or disable PCI slot Option ROMs. The options are Disabled and **Enabled**.

Load Onboard LAN 1 Option ROM/ Load Onboard LAN 2 Option ROM

Select Enabled to load the onboard LAN Option ROM for the LAN port as specified. The options are Enabled and **Disabled**.

Initiate Graphics Adapter

Use this feature to select the graphics controller to be used as the primary boot device. The options are Other, **Onboard VGA** and Slot 6. Select Slot 6 if a graphics controller is installed in the CPU-controlled Slot 6 slot.

► Super IO Device Configuration

Serial Port1 Address/ Serial Port2 Address

This option specifies the base I/O port address and the Interrupt Request address of Serial Port 1 and Serial Port 2. Select Disabled to prevent the serial port from accessing any system resources. When this option is set to Disabled, the serial port physically becomes unavailable. Select 3F8/IRQ4 to allow the serial port to use 3F8 as its I/O port address and IRQ 4 for the interrupt address. The options

for Serial Port1 are Disabled, **3F8/IRQ4**, 2E8/IRQ3. The options for Serial Port2 are Disabled, **2F8/IRQ3**, and 2E8/IRQ3.

► Remote Access Configuration

Remote Access

This allows the user to enable the Remote Access feature. The options are **Disabled** and Enabled.

If Remote Access is set to Enabled, the following items will display:

Serial Port Number

This feature allows the user decide which serial port to be used for Console Redirection. The options are **COM 1**, COM 2 and COM 3.

Serial Port Mode

This feature allows the user to set the serial port mode for Console Redirection. The options are **115200 8, n 1**; 57600 8, n, 1; 38400 8, n, 1; 19200 8, n, 1; and 9600 8, n, 1.

Flow Control

This feature allows the user to set the flow control for Console Redirection. The options are **None**, Hardware, and Software.

Redirection After BIOS POST

Select Disabled to turn off Console Redirection after Power-On Self-Test (POST). Select Always to keep Console Redirection active all the time after POST. (Note: This setting may not be supported by some operating systems.) Select Boot Loader to keep Console Redirection active during POST and Boot Loader. The options are Disabled, Boot Loader, and **Always**.

Terminal Type

This feature allows the user to select the target terminal type for Console Redirection. The options are ANSI, **VT100**, and VT-UTF8.

VT-UTF8 Combo Key Support

A terminal keyboard definition that provides a way to send commands from a remote console. Available options are **Enabled** and Disabled.

Sredir Memory Display Delay

This feature defines the length of time in seconds to display memory information. The options are **No Delay**, Delay 1 Sec, Delay 2 Sec, and Delay 4 Sec.

► Hardware Health Configuration

This feature allows the user to monitor Hardware Health of the system and review the status of each item when displayed.

CPU Overheat Alarm

This option allows the user to select the CPU Overheat Alarm setting which determines when the CPU OH alarm will be activated to provide warning of possible CPU overheat.



Warning: Any temperature that exceeds the CPU threshold temperature predefined by the CPU manufacturer may result in CPU overheat or system instability. When the CPU temperature reaches this predefined threshold, the CPU and system cooling fans will run at full speed.

The options are:

- The Early Alarm: Select this setting if you want the CPU overheat alarm (including the LED and the buzzer) to be triggered as soon as the CPU temperature reaches the CPU overheat threshold as predefined by the CPU manufacturer.
- **The Default Alarm:** Select this setting if you want the CPU overheat alarm (including the LED and the buzzer) to be triggered when the CPU temperature reaches about 5°C above the threshold temperature as predefined by the CPU manufacturer to give the CPU and system fans additional time needed for CPU and system cooling. In both the alarms above, please take immediate action as shown below.

CPU Temperature

The CPU Temperature feature will display the CPU temperature status as detected by the BIOS.

System Temperature

This feature displays the absolute system temperature (i.e., 90°C).

Low – This level is considered as the 'normal' operating state. The CPU temperature is well below the CPU 'Temperature Tolerance'. The motherboard fans and CPU will run normally as configured in the BIOS (Fan Speed Control).

User intervention: No action required.

Medium – The processor is running warmer. This is a 'precautionary' level and generally means that there may be factors contributing to this condition, but the CPU is still within its normal operating state and below the CPU 'Temperature Tolerance'. The motherboard fans and CPU will run normally as configured in the BIOS. The fans may adjust to a faster speed depending on the Fan Speed Control settings.

User intervention: No action is required. However, consider checking the CPU fans and the chassis ventilation for blockage.

High – The processor is running hot. This is a 'caution' level since the CPU's 'Temperature Tolerance' has been reached (or has been exceeded) and may activate an overheat alarm:

The Default Alarm – the Overheat LED and system buzzer will activate if the High condition continues for some time after it is reached. The CPU fan will run at full speed to bring the CPU temperature down. If the CPU temperature still increases even with the CPU fan running at full speed, the system buzzer will activate and the Overheat LED will turn on.

The Early Alarm – the Overheat LED and system buzzer will be activated exactly when the High level is reached. The CPU fan will run at full speed to bring the CPU temperature down.

Note: In both the alarms above, please take immediate action as shown below. See CPU Overheat Alarm to modify the above alarm settings.

User intervention: If the system buzzer and Overheat LED has activated, take action immediately by checking the system fans, chassis ventilation and room temperature to correct any problems. Note: the system may shut down if it continues for a long period to prevent damage to the CPU.



Notes: The CPU thermal technology that reports absolute temperatures (Celsius/Fahrenheit) has been upgraded to a more advanced feature by Intel in its newer processors. The basic concept is that each CPU is embedded by a unique temperature information that the motherboard can read. This 'Temperature Threshold' or 'Temperature Tolerance' has been assigned at the factory and is the baseline by which the motherboard takes action during different CPU temperature conditions (i.e., by increasing CPU Fan speed, triggering the Overheat Alarm, etc). Since CPUs can have different 'Temperature Tolerances', the installed CPU can now send its 'Temperature Tolerance' to the motherboard resulting in better CPU thermal management.

Supermicro has leveraged this feature by assigning a temperature status to certain thermal conditions in the processor (Low, Medium and High). This makes it easier for the user to understand the CPU's temperature status, rather than by just simply seeing a temperature reading (i.e., 25°C).

The information provided above is for your reference only. For more information on thermal management, please refer to Intel's Web site at www.Intel.com.

CPUFAN / SYSFAN Speed

This feature displays the fan speed readings from fan interfaces Fan1 (CPU Fan) and Fan2 (System Fan).

Fan Speed Control Modes

This feature allows the user to decide how the system controls the speeds of the onboard fans. The CPU temperature and the fan speed are correlative. When the CPU on-die temperature increases, the fan speed will also increase for effective system cooling. Select Full Speed to allow the onboard fans to run at full speed (of 100% Pulse Width Modulation Duty Cycle) for maximum cooling. The Full Speed setting is recommended for special system configuration or debugging. Select Performance for the onboard fans to run at 70% of the Initial PWM Cycle for better system cooling. The Performance setting is recommended for high-power-consuming and high-density systems. Select Balanced for the onboard fans to run at 50% of the Initial PWM Cycle in order to balance the needs between system cooling and power saving. The Balanced setting is recommended for regular systems with normal hardware configurations. Select Energy Saving for the onboard fans to run at 30% of the Initial PWM Cycle for best power efficiency and maximum quietness. The Options are: Full Speed (@100% of PWM Cycle), Performance (@70% of PWM Cycle), **Balanced (@50% of PWM Cycle)**, and Energy Saving (@30% of PWM Cycle).

CPU Vcore, AVCC, 3.3Vcc, 12V, V_DIMM, 5V, -12V, 3.3Vsb, and Vbat

This feature displays the voltage readings for the described components.

►ACPI Configuration

Use this feature to configure Advanced Configuration and Power Interface (ACPI) power management settings for your system.

High Performance Event Timer

Select Enabled to activate the High Performance Event Timer (HPET) that produces periodic interrupts at a much higher frequency than a Real-time Clock (RTC) does in synchronizing multimedia streams, providing smooth playback and reducing the dependency on other timestamp calculation devices, such as an x86 RDTSC Instruction embedded in the CPU. The High Performance Event Timer is used to replace the 8254 Programmable Interval Timer. The options are **Enabled** and Disabled.

USB Device Wakeup

Select Enable to awaken the system via a USB device when the system is in S3 or S4 sleep State. The options are Enabled and **Disabled**.

PS/2 KB/MS WakeUp

This feature is used to awaken from Standby mode by a PS/2 mouse or PS/2 keyboard. The options are Enabled and **Disabled**.

ACPI Aware O/S

Enable ACPI support if it is supported by the OS to control ACPI through the Operating System. Otherwise, disable this feature. The options are **Yes** and **No**.

Suspend Mode

This setting allows you to configure the ACPI (Advanced Configuration and Power Interface) state for your system when it is in the Suspend mode. The options are **S1**, **S3** and **Auto**.

AMI OEMB Table

Set this value to allow the ACPI BIOS to add a pointer to an OEMB table in the Root System Description Table (RSDT) table. The options are **Enabled**, and **Disabled**.

ACPI APIC Support

Select **Enabled** to include the ACPI APIC Table Pointer in the RSDT (Root System Description Table) pointer list. The options are **Enabled** and **Disabled**.

APIC ACPI SCI IRQ

When this item is set to **Enabled**, APIC ACPI SCI IRQ is supported by the system. The options are **Enabled** and **Disabled**.

Headless Mode

This feature is used to enable the system to function without a keyboard, monitor or mouse attached. The options are **Enabled** and **Disabled**.

ACPI Version Features

The options are ACPI v1.0, **ACPI v2.0** and ACPI v3.0. Please refer to ACPI's website for further explanation: <http://www.acpi.info/>

►IPMI Configuration (X7SPA-HF, X7SPE-HF, X7SPE-HF-D525 & X7SPA-HF-D525 Only)

Intelligent Platform Management Interface (IPMI) is a set of common interfaces that IT administrators can use to monitor system health and to manage the system as a whole. For more information on the IPMI specifications, please visit Intel's website at www.intel.com. **Note:** For this particular motherboard, IPMI shares the same network interface with LAN1.

IPMI Firmware Revision

This item displays the current IPMI firmware revision.

Status of BMC

Baseboard Management Controller (BMC) manages the interface between system management software and platform hardware. This is an informational feature which returns the status code of the BMC micro controller.

IPMI Function

Set this item to Disabled to turn off the IPMI feature. The options are **Enabled** and Disabled..

View BMC System Event Log

This feature is used to view any BMC events. It shows the total number of entries and will allow the viewing of each event by scrolling down on an Entry Number and pressing Enter.

Clear BMC System Event Log

This feature is used to clear the System Event Log. Caution: Any cleared information is unrecoverable. Make absolutely sure you no longer need any data stored in the log before clearing the BMC Event Log.

Set LAN Configuration

Set this feature to configure the IPMI LAN adapter with a network address.

Channel Number - Enter the channel number for the SET LAN Config command. This is initially set to **[1]**. Press "+" or "-" on your keyboard to change the Channel Number.

Channel Number Status - This feature returns the channel status for the Channel Number selected above: "Channel Number is OK" or "Wrong Channel Number".

IP Address Source - This feature selects whether the IP address, Subnet Mask and Gateway Address are automatically assigned by the network's DHCP server (Dynamic Host and Configuration Protocol) or manually entered by the user (Static). If Static is selected, the IP Address, Subnet Mask and Gateway Address must be manually entered below. If DHCP is selected, the next three items will be configured automatically and will be grayed out. The options are Static and **DHCP**.

IP Address - Enter the IP address for this machine. This should be in decimal and in dotted quad form (i.e., 192.168.10.253). The value of each three-digit number separated by dots should not exceed 255.

Subnet Mask - Subnet masks tell the network which subnet this machine belongs to. The value of each three-digit number separated by dots should not exceed 255 (i.e., 255.255.255.0).

Gateway Address - Enter the Gateway address this machine will use (i.e., 192.168.10.1).

MAC Address - The BIOS will automatically enter the MAC address (also known as Hardware Address) of this machine, however it may be over-ridden. MAC addresses are 6 two-digit hexadecimal numbers (Base 16, 0 ~ 9, A, B, C, D, E, F) separated by dots. (i.e., 00.30.48.D0.D4.60)

BMC Watch Dog Timer Action

Allows the BMC to reset or power down the system if the operating system hangs or crashes. The options are **Disabled**, Reset System, Power Down, Power Cycle.

BMC WatchDog TimeOut [Min:Sec]

This option appears if BMC Watch Dog Timer Action (above) is enabled. This is a timed delay in minutes or seconds, before a system power down or reset after an operating system failure is detected. The options are [**5 Min**], [1 Min], [30 Sec], and [10 Sec].

►Event Log Configuration

View Event Log

Use this option to view the System Event Log.

Mark all events as read

This option marks all events as read. The options are OK and Cancel.

Clear event log

This option clears the Event Log memory of all messages. The options are OK and **Cancel**.

PCIE Error Log

Use this option to enable logging of errors encountered in the system's PCIe bus. The options are Yes and **No**.

4-4 Security Settings

The AMI BIOS provides a Supervisor and a User password. If you use both passwords, the Supervisor password must be set first.



Supervisor Password

This item indicates if a supervisor password has been entered for the system. Clear means such a password has not been used and Set means a supervisor password has been entered for the system.

User Password:

This item indicates if a user password has been entered for the system. Clear means such a password has not been used and Set means a user password has been entered for the system.

Change Supervisor Password

Select this feature and press <Enter> to access the submenu, and then type in a new Supervisor Password.

User Access Level (Available when Supervisor Password is set as above)

Available options are **Full Access**: grants full User read and write access to the Setup Utility, **View Only**: allows access to the Setup Utility but the fields cannot be changed, **Limited**: allows only limited fields to be changed such as Date and Time, **No Access**: prevents User access to the Setup Utility.

Change User Password

Select this feature and press <Enter> to access the submenu , and then type in a new User Password.

Clear User Password (Available only if User Password has been set)

Password Check

Available options are **Setup** and Always.

Boot Sector Virus Protection

When Enabled, the AMI BOIS displays a warning when any program (or virus) issues a Disk Format command or attempts to write to the boot sector of the hard disk drive. The options are Enabled and **Disabled**.

4-5 Boot Settings

Use this feature to configure Boot Settings:



▶ Boot Device Priority

This feature allows the user to specify the sequence of priority for the Boot Device. The settings are 1st boot device, 2nd boot device, 3rd boot device, 4th boot device, 5th boot device and Disabled.

- 1st Boot Device - 1st Floppy Drive
- 2nd Boot Device - [USB: XXXXXXXXX]
- 3rd Boot Device - [SATA: XXXXXXXXX]
- 4th Boot Device - [Network: XXXXXXXXX]

▶ Hard Disk Drives

This feature allows the user to specify the sequence of priority from the available Hard Drives.

- 1st Drive [SATA: XXXXXXXXX]
- 2nd Drive [SATA: XXXXXXXXX]

►Removable Drives

This feature allows the user to specify the boot sequence from available Removable Drives. The settings are 1st boot device, 2nd boot device, and Disabled.

- 1st Drive
- 2nd Drive - [USB: XXXXXXXXXX]

Retry Boot Devices

Select this option to retry booting from the configured boot devices if the systems fail to boot initially. The options are **Disabled** and Enabled.

4-6 Exit Options

Select the Exit tab from the AMI BIOS Setup Utility screen to enter the Exit BIOS Setup screen.

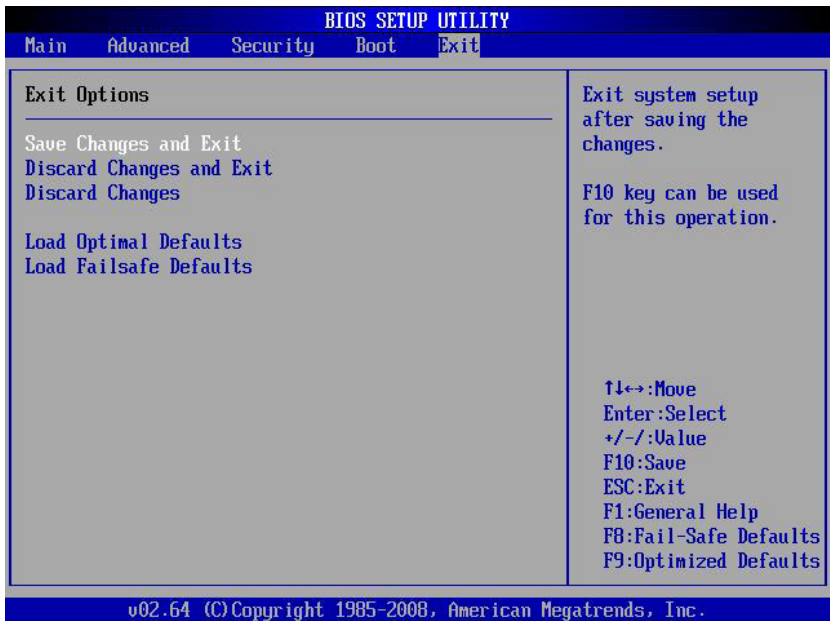

Save Changes and Exit

When you have completed the system configuration changes, select this option to leave the BIOS Setup Utility and reboot the computer, so the new system con-

figuration parameters can take effect. Select Save Changes and Exit from the Exit menu and press <Enter>.

Discard Changes and Exit

Select this option to quit the BIOS Setup without making any permanent changes to the system configuration, and reboot the computer. Select Discard Changes and Exit from the Exit menu and press <Enter>.

Discard Changes

Select this option and press <Enter> to discard all the changes and return to the AMI BIOS Utility Program.

Load Optimal Defaults

To set this feature, select Load Optimal Defaults from the Exit menu and press <Enter>. Then, select OK to allow the AMI BIOS to automatically load Optimal Defaults to the BIOS Settings. The Optimal settings are designed for maximum system performance, but may not work best for all computer applications.

Load Fail-Safe Defaults

To set this feature, select Load Fail-Safe Defaults from the Exit menu and press <Enter>. The Fail-Safe settings are designed for maximum system stability, but not for maximum performance.

Appendix A

POST Error Beep Codes

This section lists POST (Power On Self Test) error beep codes for the AMI BIOS. POST error beep codes are divided into two categories: recoverable and terminal. This section lists Beep Codes for recoverable POST errors.

Recoverable POST Error Beep Codes

When a recoverable type of error occurs during POST, BIOS will display a POST code that describes the problem. BIOS may also issue one of the following beep codes:

- 1 long and two short beeps - video configuration error
- 1 repetitive long beep - no memory detected
- 1 continuous beep with the front panel Overheat LED on - system overheat
- 8 short beeps - display memory read/write error

Notes

Appendix B

Software Installation Instructions

B-1 Installing Drivers

After you've installed the Windows Operating System, a screen as shown below will appear. You are ready to install software programs and drivers that have not yet been installed. To install these software programs and drivers, click the icons to the right of these items.



Driver/Tool Installation Display Screen

Note: Click the icons showing a hand writing on the paper to view the readme files for each item. Click a computer icon to the right of an item (from top to the bottom) one at a time. After installing each item, you must re-boot the system before proceeding with the next item on the list. The bottom icon with a CD on it allows you to view the entire contents of the CD.

B-2 Configuring Supero Doctor III

The Supero Doctor III program is a Web-base management tool that supports remote management capability. It includes Remote and Local Management tools. The local management is called the SD III Client. The Supero Doctor III program included on the CDROM that came with your motherboard allows you to monitor the environment and operations of your system. Supero Doctor III displays crucial system information such as CPU temperature, system voltages and fan status. See the Figure below for a display of the Supero Doctor III interface.



Note 1: Both default user name and password are ADMIN.



Note 2: In the Windows OS environment, the Supero Doctor III settings take precedence over the BIOS settings. When first installed, Supero Doctor III adopts the temperature threshold settings previously set in the BIOS. Any subsequent changes to these thresholds must be made within Supero Doctor, since the SD III settings override the BIOS settings. For the Windows OS to adopt the BIOS temperature threshold settings, please change the SDIII settings to be the same as those set in the BIOS.

Supero Doctor III Interface Display Screen-I (Health Information)



Supero Doctor III Interface Display Screen-II (Remote Control)

Note: SD III Software Revision 1.0 can be downloaded from our Web site at: ftp://ftp.supermicro.com/utility/Supero_Doctor_III/. You can also download SDIII User's Guide at: <http://www.supermicro.com/PRODUCT/Manuals/SDIII/UserGuide.pdf>. For Linux, we will still recommend that you use Supero Doctor II.

Notes

Disclaimer

The products sold by Supermicro are not intended for and will not be used in life support systems, medical equipment, nuclear facilities or systems, aircraft, aircraft devices, aircraft/emergency communication devices or other critical systems whose failure to perform be reasonably expected to result in significant injury or loss of life or catastrophic property damage. Accordingly, Supermicro disclaims any and all liability, and should buyer use or sell such products for use in such ultra-hazardous applications, it does so entirely at its own risk. Furthermore, buyer agrees to fully indemnify, defend and hold Supermicro harmless for and against any and all claims, demands, actions, litigation, and proceedings of any kind arising out of or related to such ultra-hazardous use or sale.