



ProCurve 2910al Switches

Installation and Getting Started Guide



Power over Ethernet

ProCurve 2910al Switches

Installation and Getting Started Guide

Publication Number

5992-3084
March 2010

Applicable Products

HP ProCurve 2910al-24G Switch	(J9145A)
HP ProCurve 2910al-48G Switch	(J9147A)
HP ProCurve 2910al-24G-PoE+ Switch	(J9146A)
HP ProCurve 2910al-48G-PoE+ Switch	(J9148A)
HP ProCurve 2-Port 10-GbE CX4 al Module	(J9149A)
HP ProCurve 2-Port 10-GbE SFP+ al Module	(J9008A)
HP ProCurve 10-GbE al Interconnect Kit	(J9165A)
HP ProCurve 620 Redundant and External Power Supply	(J8696A)
HP ProCurve 630 Redundant and/or External Power Supply	(J9443A)

Disclaimer

HEWLETT-PACKARD COMPANY MAKES NO WARRANTY OF ANY KIND WITH REGARD TO THIS MATERIAL, INCLUDING, BUT NOT LIMITED TO, THE IMPLIED WARRANTIES OF MERCHANTABILITY AND FITNESS FOR A PARTICULAR PURPOSE. Hewlett-Packard shall not be liable for errors contained herein or for incidental or consequential damages in connection with the furnishing, performance, or use of this material.

The information contained herein is subject to change without notice. The only warranties for HP products and services are set forth in the express warranty statements accompanying such products and services. Nothing herein should be construed as constituting an additional warranty. HP shall not be liable for technical or editorial errors or omissions contained herein.

Hewlett-Packard assumes no responsibility for the use or reliability of its software on equipment that is not furnished by Hewlett-Packard.

Warranty

See the Customer Support/Warranty booklet included with the product.

A copy of the specific warranty terms applicable to your Hewlett-Packard products and replacement parts can be obtained from your HP Sales and Service Office or authorized dealer.

Safety

Before installing and operating these products, please read the "Installation Precautions" in chapter 2, "Installing the Switch", and the safety statements in appendix C, "Safety and EMC Regulatory Statements".

Contents

1 Introducing the Switch

Front of the Switch	1-4
Network Ports	1-6
LEDs	1-6
LED Mode Select Button and Indicator LEDs	1-8
Reset Button	1-10
Clear Button	1-10
Console Port	1-11
Expansion Module LEDs	1-11
Back of the Switch	1-12
al Module Slots	1-12
RPS and EPS Input Ports	1-13
Power Connector	1-13
HP ProCurve Switch al Modules	1-14
Features	1-15
Switch Features	1-16

2 Installing the Switch

Included Parts	2-1
Installation Precautions:	2-3
Installation Procedures	2-4
Summary	2-4
1. Prepare the Installation Site	2-5
2. Verify the Switch Passes Self Test	2-5
LED Behavior:	2-7
3. (Optional) Install a Module	2-8
Installing the Interconnect Kit	2-9
Verifying the Module is Installed Correctly	2-10

4. Mount the Switch	2-11
Rack or Cabinet Mounting	2-11
Rack Mounting the Switch	2-11
Horizontal Surface Mounting	2-13
5. (Optional) Install a Transceiver	2-14
To remove the transceiver:	2-14
Installing or Removing the Optical Media Converter	2-15
6. (Optional) Install Mini-GBICs and SFPs	2-16
Removing the mini-GBICs	2-17
7. Connect the Switch to a Power Source	2-18
8. (Optional) Connect an External Power Supply	2-18
RPS Operation	2-18
Operating Characteristics of the 620 RPS/EPS (J8696A)	2-19
620 RPS/EPS Connectivity	2-21
Operating characteristics of the HP ProCurve 630 RPS/EPS (J9443A)	2-22
HP ProCurve 630 RPS/EPS Connectivity	2-24
9. (Optional) Connect a Console to the Switch	2-24
Terminal Configuration	2-25
Direct Console Access	2-25
Console Cable Pinouts	2-26
10. Connect the Network Cables	2-27
Using the RJ-45 Connectors	2-27
Connecting Cables to mini-GBICs	2-27
Connecting a fiber cable	2-28
Connecting a copper cable	2-28
Sample Network Topologies	2-29

3 Getting Started With Switch Configuration

Recommended Minimal Configuration	3-1
Using the Console Setup Screen	3-2
Where to Go From Here	3-4
To Recover from a Lost Manager Password	3-4
Using the IP Address for Remote Switch Management	3-5
Starting a Telnet Session	3-5
Starting a Web Browser Session	3-5

4 Troubleshooting

Basic Troubleshooting Tips	4-1
Diagnosing with the LEDs	4-4
Proactive Networking	4-8
Hardware Diagnostic Tests	4-9
Testing the Switch by Resetting It	4-9
Checking the Switch LEDs	4-9
Checking Console Messages	4-9
Testing Twisted-Pair Cabling	4-10
Testing Switch-to-Device Network Communications	4-10
Testing End-to-End Network Communications	4-10
Restoring the Factory Default Configuration	4-11
Downloading New Switch Software	4-12
HP Customer Support Services	4-12
Before Calling Support	4-12

A Switch Specifications

Physical	A-1
Electrical	A-1
Environmental	A-1
Acoustic	A-2
Safety	A-2

B Module Specifications

Physical	B-1
Environmental	B-1
Optical Power Specifications	B-1

C Cabling and Technology Information

Cabling specifications	C-1
Technology distance specifications	C-3
Mode Conditioning Patch Cord	C-4

Installing the Patch Cord	C-5
Twisted-Pair Cable/Connector Pin-Outs	C-6
Straight-Through Twisted-Pair Cable for 10 Mbps or 100 Mbps Network Connections	C-7
Cable Diagram	C-7
Pin Assignments	C-7
Crossover Twisted-Pair Cable for 10 Mbps or 100 Mbps Network Connection	C-8
Cable Diagram	C-8
Pin Assignments	C-8
Straight-Through Twisted-Pair Cable for 1000 Mbps Network Connections	C-9
Cable Diagram	C-9
Pin Assignments	C-9

D Safety and EMC Regulatory Statements

Safety Information	D-1
Informations concernant la sécurité	D-2
Hinweise zur Sicherheit	D-3
Considerazioni sulla sicurezza	D-4
Consideraciones sobre seguridad	D-5
Safety Information (Japan)	D-6
Safety Information (China)	D-7
EMC Regulatory Statements	D-8
U.S.A.	D-8
Canada	D-8
Australia/New Zealand	D-8
Japan	D-8
Korea	D-9
Taiwan	D-9
European Community	D-10

E Recycle Statements

Waste Electrical and Electronic Equipment (WEEE) Statements	E-1
---	-----

Index

Introducing the Switch

The HP ProCurve 2910al Switches are multiport switches that can be used to build high-performance switched networks. These switches are store-and-forward devices offering low latency for high-speed networking. The 2910al switches also support Redundant Power Supply and Power over Ethernet technologies.

HP ProCurve 2910al-24G Switch (J9145A)

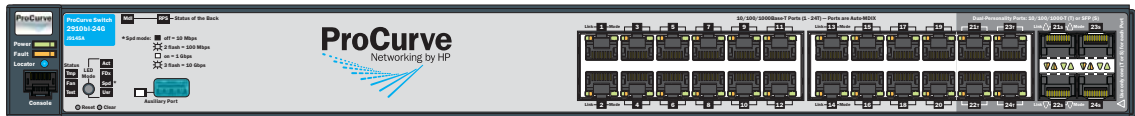

HP ProCurve 2910al-48G Switch (J9147A)

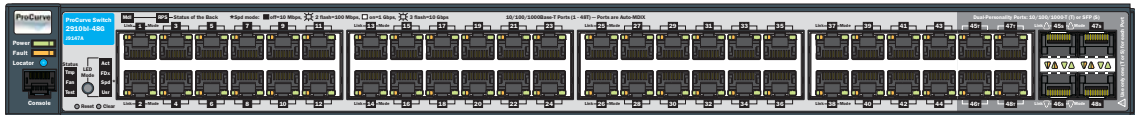

HP ProCurve 2910al-24G-PoE+ Switch (J9146A)



HP ProCurve 2910al-48G-PoE+ Switch (J9148A)

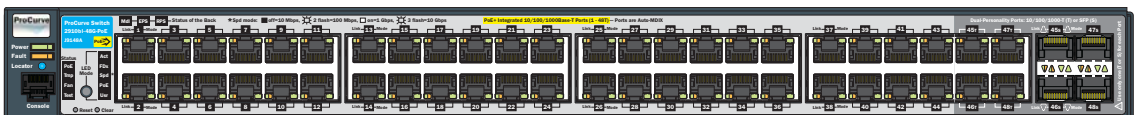

Throughout this manual, these switches will be referred to as the 2910al Switches or the 2910al-PoE+ Switches.

The 2910al-24G Switch and 2910al-48G Switch have respectively, 24 or 48, auto-sensing 10/100/1000Base-T RJ-45 ports, four dual-personality ports—either auto-sensing 10/100/1000Base-T RJ-45 or mini-GBIC, and two slots are provided in the back of the device to support expansion modules:

- 2-port (two fixed CX4 ports) 10 Gigabit per second Ethernet (10-GbE) module.
- 2-port 10-GbE SFP+ (Small Form Factor Pluggable) module. The specification for SFP+ defines the physical and electrical characteristics of this form-factor (size and shape). The form-factor is identical to SFP, but the SFP+ is a 10-Gigabit Ethernet transceiver.
- 1-port 10-GbE interconnect module.

Table 1-1. These products support optional network connectivity with the following speeds and technologies:

Speed	Technology	Cabling	Transceiver form-factor and connector	
			SFP(mini-GBIC) Connector	SFP+ Connector
100-Mbps	100-FX	Fiber (multimode)	LC	
	100-BX	Fiber (single mode)	LC	
1-Gbps	1000-SX	Fiber (multimode)	LC	
	1000-LX	Fiber (multimode or single mode)	LC	
	1000-LH	Fiber (single mode)	LC	
	1000-BX	Fiber (single mode)	LC	
10-Gbps	CX4	Copper (twinaxial)		N/A
	10-Gig Direct Attach	Copper (twinaxial)		N/A
	10-Gig SR	Fiber (multimode)		LC
	10-Gig LRM	Fiber (multimode)		LC
	10-Gig LR	Fiber (single mode)		LC
For supported transceivers see www.hp.com/go/procurve/faqs . Both ProCurve 10-GbE transceivers and ProCurve Mini-GBICs and SFPs have links to a list of supported products (first question in the “General Product Information” category).				
For technical details of cabling and technologies see Appendix C, “ Cabling and Technology Information ”.				

The 2910al-PoE+ Switches also support Power over Ethernet+ (PoE+) technology. PoE+ offers a higher wattage per port than the previous PoE offering, 30 watts per port instead of 15. The switches support 802.3af standard devices and some pre-standard PoE devices. It also supports the draft version of the 802.3at standard. For a list of these devices, see the FAQs for your switch model. This feature is the default and you must disable it if you do not want to use it. Refer to the *Management and Configuration Guide* which is on the ProCurve Web site at www.hp.com/go/procurve/manuals.

The dual-personality ports have either auto-sensing 10/100/1000Base-T RJ-45, or mini-GBIC (SFP) connectivity. The mini-GBIC ports do not support PoE. If any of the mini-GBIC ports are used the corresponding RJ-45 port will not be supplied with PoE power and will be disabled. For more information regarding the PoE capabilities of the 2910al Switches, see the *ProCurve PoE (Power over Ethernet) Devices Planning and Implementation Guide*, which is on the ProCurve Web site at www.hp.com/go/procurve/manuals.

HP ProCurve Redundant/External Power Supplies (RPS/EPS) can be connected to the 2910al Switches for redundant 12 V system power (RPS) and to provide for additional PoE+ provisioning. For RPS power, the 2910al Switches can be connected to either an HP ProCurve 620 RPS/EPS or HP ProCurve 630 Redundant and/or External Power Supply. But, for additional PoE+ EPS power, only the HP ProCurve 630 RPS/EPS can be used. The 620 does not provide 54 V for PoE+, only 50 V for PoE, and the 2910al Switches do not support connections to the 620 for EPS.

These switches are designed to be used primarily as a high-density wiring closet or desktop switch. These switches can directly connect computers, printers, and servers to provide dedicated bandwidth to those devices, and can build a switched network infrastructure by connecting the switch to hubs, other switches, or routers. In addition, the 2910al Switches offer full network management capabilities.

This chapter describes the 2910al Switches, including:

- Front and back of the switches
- Network ports
- LEDs
- Switch features

Front of the Switch

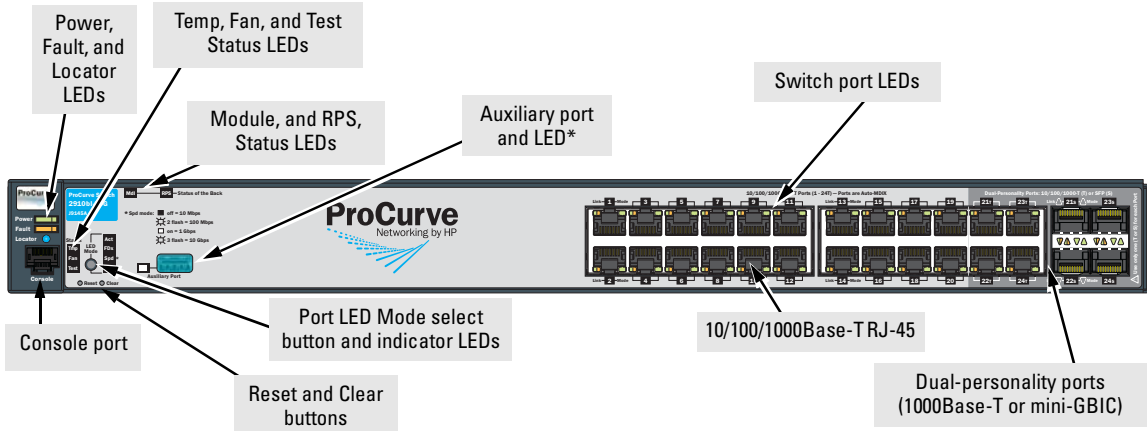
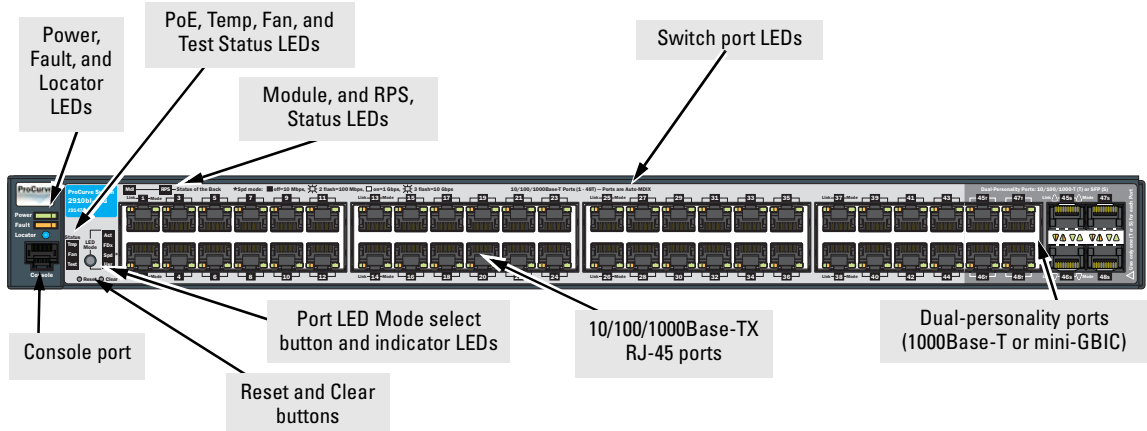

Figure 1-1. HP ProCurve 2910a1-24G Switch



*On the 2910a1-48G switch, the Auxiliary port is located on the back of the unit.

Figure 1-2. HP ProCurve 2910a1-48G Switch

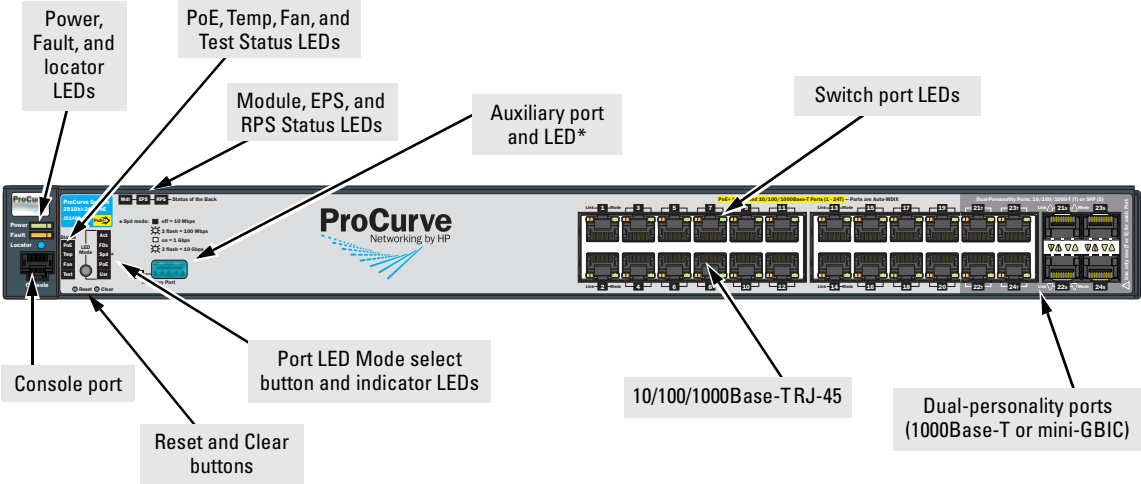
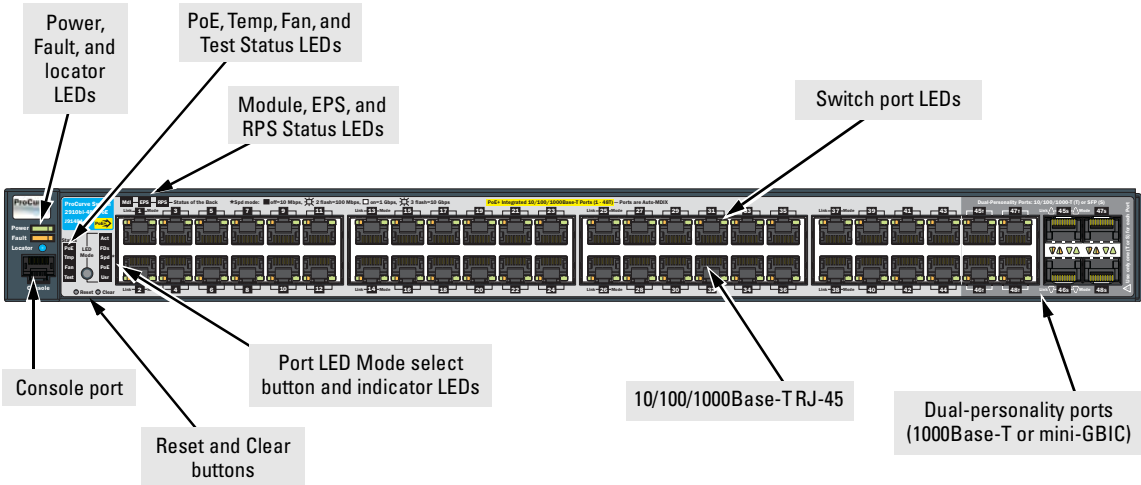

Figure 1-3. HP ProCurve 2910al-24G-PoE+ Switch



*On the 2910al-48G-PoE switch, the Auxiliary port is located on the back of the unit.

Figure 1-4. ProCurve 2910al-48G-PoE+ Switch

Network Ports

- 24 or 48 auto-sensing 10/100/1000Base-T ports. All these ports have the “Auto MDIX” feature, which means you can use either straight-through or crossover twisted-pair cables to connect any network devices to the switch.
- On the 2910al devices there are four dual-personality ports. Use either the 10/100/1000Base-T RJ-45 connector, or install a supported ProCurve mini-GBIC (SFP) for fiber-optic connections.

The RJ-45 connectors support the “Auto MDIX” feature, which means you can use either straight-through or crossover twisted-pair cables to connect any network device to the switch.

Dual-Personality Port Operation. By default, the RJ-45 connectors are enabled. If a mini-GBIC is installed in a slot, it is enabled and the associated RJ-45 connector is disabled and cannot be used. If the mini-GBIC is removed, the associated RJ-45 port is automatically re-enabled.

The RJ-45 connector also supplies PoE+ power until a mini-GBIC is installed. The PoE+ power is turned off when a mini-GBIC is plugged in.

- Two expansion slots. These switches provide two slots in the back of the device that can accept any of the al modules. The module provides port connectivity for 10 gigabit speed. The module ports provide connectivity through either copper or fiber optic media.

LEDs

Table 1-2. Switch LEDs

Switch LEDs	State	Meaning
Power (green)	On	The switch is receiving power.
	Off	The switch is NOT receiving power.
Fault (orange)	Off	The normal state; indicates there are no fault conditions on the switch.
	Flashing ¹	A fault has occurred on the switch, one of the switch ports, module in the rear of the switch, or the fan. The Status LED for the component with the fault will flash simultaneously.
	On	On briefly after the switch is powered on or reset, at the beginning of switch self test. If this LED is on for a prolonged time, the switch has encountered a fatal hardware failure, or has failed its self test. See chapter 4, “Troubleshooting” for more information.

Switch LEDs	State	Meaning
Locator (Blue)	On Flashing Off	The Locator LED is used to locate a specific chassis in a area full of chassis. The LED can be set to be on solid or flash for a specified number of minutes (1-1440). The default is 30 minutes. Use the command "chassislocate".
Test (green/orange)	Off	The normal operational state; the switch is not undergoing self test.
	On green	The switch self test and initialization are in progress after the switch has been power cycled or reset. The switch is not operational until this LED goes off. The Self Test LED also comes on briefly when you "hot swap" a mini-GBIC into the switch; the mini-GBIC is self tested when it is hot swapped.
	Flashing orange ¹	A component of the switch has failed its self test. The status LED for that component, for example an RJ-45 port, and the switch Fault LED will flash simultaneously.
Port LEDs (green/orange – Link and Mode)	Link	Indicates the port LEDs are displaying link information: <ul style="list-style-type: none"> if the port LED is on, the port is enabled and receiving a link indication from the connected device. if the port LED is off, the port has no active network cable connected, or is not receiving link beat or sufficient light. Otherwise, the port may have been disabled through the switch console, the web browser interface, or ProCurve Manager. if the port LED is Flashing ¹ (orange) simultaneously with the Fault LED, the corresponding port has failed its self test.
	Mode	The operation of the Mode LED is controlled by the LED Mode select button, and the current setting is indicated by the LED Mode indicator LEDs near the button. Press the button to step from one view mode to the next. The default view is Activity (Act).
LED Mode View (green LEDs)	Act	Indicates the port LEDs are displaying network activity information.
	FDx	Indicates port LEDs are lit for ports in Full Duplex Mode. Off indicates ½ duplex.
	Spd	Indicates the port LEDs are displaying the connection speed at which each port is operating: <ul style="list-style-type: none"> if the port LED is off, the port is operating at 10 Mbps. if the port LED is Flashing**, the port is operating at 100 Mbps. if the port LED is on continuously, the port is operating at 1000 Mbps.
	PoE	<ul style="list-style-type: none"> If the Mode LED is on the port is providing PoE power. If the Mode LED is off the port is not providing PoE power. If the Link LED is on the port is enabled for PoE. If the Link LED is off the port is disabled for PoE. If the Link LED is Flashing, the port has an error or the port is denied power due to insufficient power.
	Usr	Reserved for future development
Mdl (Module Status, green)	On Flashing Off	Expansion module is plugged into expansion slot and operating correctly Expansion module is plugged into expansion slot but has experienced a fault Expansion module is not plugged into expansion slot

Switch LEDs	State	Meaning
RPS Status (green)	On Flashing Off	Normal operation. RPS is connected and operating correctly. RPS could be powering the unit. RPS is connected but has experienced a fault. RPS is not connected or is not powered on.
EPS Status (green)	On Flashing Off	Connected to an External Power Supply, and receiving power. The External Power Supply is connected but has experienced a fault or is unplugged. The switch is not connected to an EPS.
Fan Status (green)	On Flashing ¹	Normal operation, all fans are ok. One of the unit's fans has failed. The switch Fault LED will be flashing simultaneously.
PoE Status	On Off Flashing ¹ Flashing ²	If any ports are supplying PoE power. If no ports are supplying PoE power. Should be off only during the boot process. If any port has a internal hardware failure If any port is denied PoE power or detecting an external PD fault
Temp (green/Orange)	Off Flashing ¹	Switch temperature is normal. An over temperature condition has been detected.
Auxiliary (green/ orange) For more information see the Management and Configuration Guide for your switch.	Flashing green ¹ On green Flashing orange ² Off	Indicates the switch is processing a USB command file. The switch has finished processing the USB command file successfully. Indicates an error condition. Indicates that no USB device has been inserted, or that the inserted USB device cannot be recognized, or that no command file can be found on the inserted USB device.
¹ The flashing behavior is an on/off cycle once every 1.6 seconds, approximately. ² The flashing behavior is an on/off cycle once every 0.8 seconds, approximately.		

LED Mode Select Button and Indicator LEDs

The operation of the Mode LED is controlled by the LED Mode select button, and the current setting is indicated by the LED Mode indicator LEDs near the button. Press the button to step from one view mode to the next.

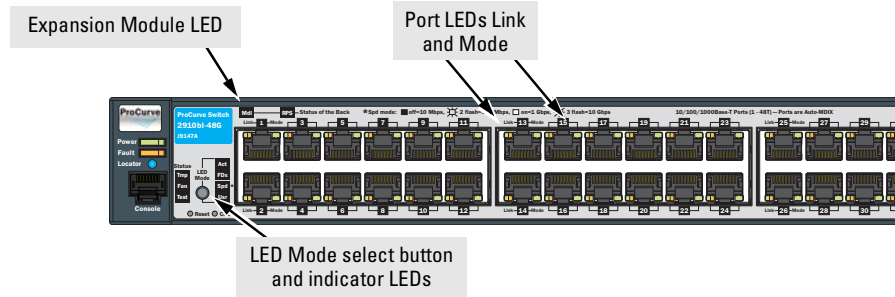

Figure 1-5. HP ProCurve 2910al-48G Switch

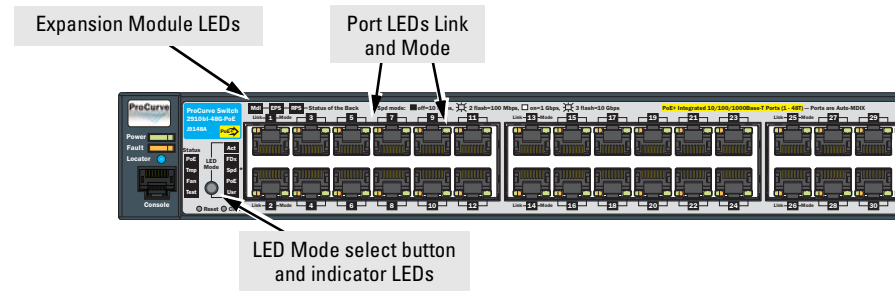

Figure 1-6. HP ProCurve 2910al-48G-PoE+ Switch

- The PoE+ switches have an additional mode, PoE. In PoE mode, the Link LED indicates the PoE configuration for the port:
 - On if PoE is enabled on the port
 - Off if PoE is disabled on the port.
- Each port has a Link LED. If it is lit, the port has a link. If the Link LED is Flashing, the port has failed its self test. The Fault and Self Test LEDs will be Flashing simultaneously.
- If the Activity (Act) indicator LED is lit, each port LED displays activity information for the associated port—it flickers as network traffic is received and transmitted through the port.
- If the Full Duplex (FDx) indicator LED is lit, the port LEDs light for those ports that are operating in full duplex.
- If the Speed (Spd) indicator LED is lit, the port LEDs behave as follows to indicate the connection speed for the port:
 - Off = 10 Mbps
 - Flashing = 100 Mbps (the Flashing behavior is a repeated on/off cycle once every 0.8 sec.)
 - On = 1000 Mbps

- The Usr Mode LED is reserved for future development
- If the PoE indicator LED is lit, the Link and Mode LEDs indicate PoE status:
Link LED:
 - On = PoE is enabled on this port
 - Off = PoE is disabled on this port.
 - Slow Flashing = Internal PoE fault on this port. or has been denied power
 - Fast Flashing = This port is denied PoE power or has an external load fault.Mode LED:
 - On = PoE power is be supplied on this port
 - Off = PoE is not being supplied on this port.

Reset Button

This button is for:

- **Resetting the switch** - When the switch is powered on. This action clears any temporary error conditions that may have occurred and executes the switch self test.
- **Restoring Factory Default Configuration** - When pressed with the Clear button in a specific pattern, any configuration changes you may have made through the switch console, the web browser interface, and SNMP management are removed, and the factory default configuration is restored to the switch. For the specific method to restore the factory default configuration, see [“Restoring the Factory Default Configuration” on page 11](#), “Troubleshooting” of this manual.

Clear Button

This button is used for:

- **Deleting Passwords** - When pressed by itself for at least one second, the button deletes any switch console access passwords that you may have configured. Use this feature if you have misplaced the password and need console access. This button is provided as a convenience, however if you are concerned with the security of the switch configuration and operation, you should make sure the switch is installed in a secure location. This button can be disabled by a CLI command.
- **Restoring Factory Default Configuration** - See Reset Button above.

Console Port

This port is used to connect a console to the switch by using the RJ-45 to DB9 cable, supplied with the switch. This connection is described under “Connect a Console to the Switch” in chapter 2, “Installing the Switch.” The console can be a PC or workstation running a VT-100 terminal emulator, or a VT-100 terminal.

Expansion Module LEDs

“Expansion Module” LEDs refer to the LEDs specific to the expansion module. These LEDs are located on the physical expansion module bulkhead. These LEDs are only viewable in the rear of the Switch 2910al-48G product on the Expansion Slot Module itself.

Table 1-3. Expansion Module LEDs

Name	Color	Mode	Description
Expansion Module LEDs per module			
Module Status	Green/ Orange	On green	Expansion module is plugged into expansion slot and operating correctly
		Off	Expansion module's power has been turned OFF, and the card can be removed from the box if necessary.
		Flashing orange	Expansion module is plugged into expansion slot but has experienced a fault. Flashes simultaneously with the Fault LED.
Expansion Module LEDs per port			
Link	Green/ Orange	On green	Indicates that the port LEDs are displaying link information: <ul style="list-style-type: none"> if the port LED is on, the port is enabled and receiving a link indication from the connected device. if the port LED is off, the port has no active network cable connected, or is not receiving link beat or sufficient light. Otherwise, the port may have been disabled through the switch console, the web browser interface, or ProCurve Manager. if the port LED is flashing¹ simultaneously with the Fault LED, the corresponding port has experienced a hardware failure or has failed its self test.
		Off	
		Flashing orange	
Mode	Green	On	The operation of the Mode LED is controlled by the LED Mode select button, and the current setting is indicated by the LED Mode indicator LEDs near the button. Press the button to step from one view mode to the next. The default view is Activity (Act). See page 7 .
¹ The flashing behavior is an on/off cycle once every 1.6 seconds, approximately.			

Expansion module LEDs operate in modes for Link and Mode. FDx and Spd modes have no meaning for the 10-GbE ports on the expansion module.

Back of the Switch

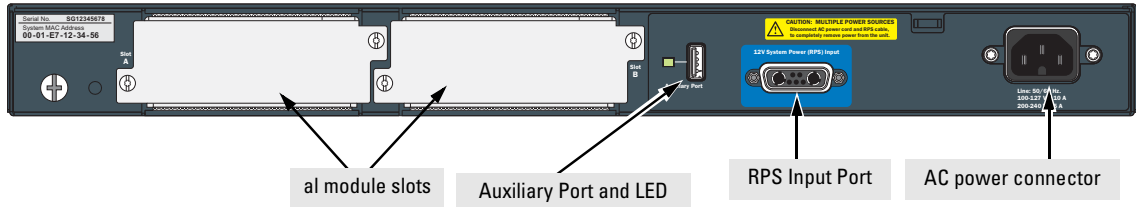

Figure 1-7. HP ProCurve 2910al-48G Switch

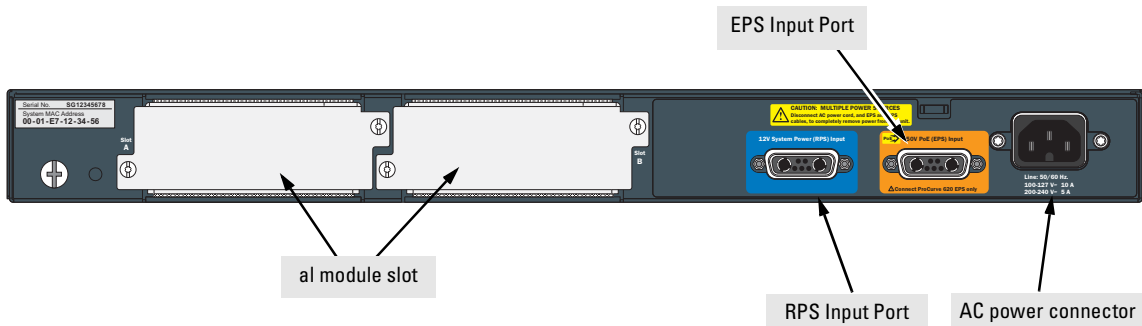

Figure 1-8. HP ProCurve 2910al-24G-PoE+ Switch

al Module Slots

Caution

It is required for the switch to be powered down before inserting or extracting the Expansion Module.

These switches support three al modules. The al modules provide different types of connectivity options for the switch.

- The J9149A – provides two 10-GbE CX4 fixed copper ports
- The J9008A – provides two 10-GbE SFP+ slots that support a number of different transceivers. For supported transceivers see [Table 1-1 on page 1-2](#).
- The J9165A – these modules have 1 fixed short-range CX4 port (up to 3 meters), and comes in a kit of 2 modules with one 0.5 meter cable. Primarily used to interconnect two switches at 10-GbE speed.

RPS and EPS Input Ports

The 2910al Switches support connectivity to a redundant power supply (RPS/EPS). The HP ProCurve 620 Redundant and External Power Supply (J8696A) and the HP ProCurve 630 Redundant and/or External Power Supply (J9443A) are accessory products for these switches.

The RPS functionality of the HP ProCurve 620 RPS/EPS and the HP ProCurve 630 RPS/EPS provide redundant system power in case the switch's internal power supply fails.



The EPS functionality of the HP ProCurve 620 RPS/EPS is not supported on the 2910al switches, however, the HP ProCurve 630 RPS/EPS provides redundant or additional PoE+ power to the 2910al PoE+ switches.

Power Connector

The 2910al Switches do not have a power switch; they are powered on when connected to an active AC power source. These switches automatically adjust to any voltage between 100–127 and 200–240 volts and either 50 or 60 Hz. There are no voltage range settings required.

HP ProCurve Switch al Modules

The HP ProCurve al Modules are components you can add to a HP ProCurve al switch to provide a variety of network connectivity options. The following modules is available as of this printing:

Module		Description
HP ProCurve 10-GbE CX4 al Module (J9149A) ^{1,3}		2-port 10 Gigabit switch expansion module. This module has two fixed CX4 ports. ¹
HP ProCurve 2-Port 10-GbE SFP+ al Module (J9008A) ^{2,3}		2-port 10 Gigabit switch expansion module. This module has two SFP+ ports. ²
HP ProCurve 10-GbE al Interconnect Kit (J9165A) ³		Two, 1-port 10 Gigabit switch expansion modules. These modules have 1 fixed CX4 port. ⁴ These modules come in a kit of 2 modules with one 0.5 meter cable.

¹ **Supported accessories:** As of this printing the following HP ProCurve accessories are supported by the HP ProCurve Switch 2-Port 10-GbE CX4 al Module:

- ProCurve 10-GbE CX4 Media Converter (J8439A).

² **Supported transceivers:** As of this printing the following HP ProCurve transceivers are supported by the HP ProCurve Switch al 10-GbE 2-port SFP+ Module:

- HP ProCurve SFP+ SR transceiver (J9150A)
- HP ProCurve SFP+ LR transceiver (J9151A)
- HP ProCurve SFP+ LRM transceiver (J9152A)

³ **These modules require switch software version W.14.01 or later to be installed in the switch.**

⁴ The J8439A Media Converter is not supported on the Interconnect kit.

Contact your HP ProCurve authorized networking products reseller or your HP ProCurve representative for information on availability of other modules and transceivers. You can also visit the HP ProCurve networking products Website www.hp.com/go/procurve to get more information.

Features

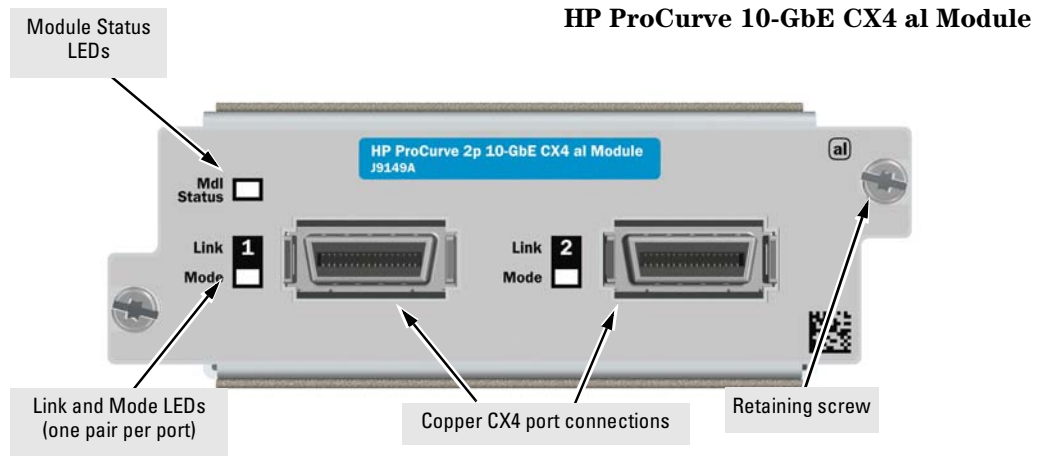

Figure 2. Front of the a1 10-GbE CX4 Module

The a1 Modules have the following features:

- Connectivity ports.
- LEDs that provide information for each port on the link and mode status.
- LED that provides information on module status.
- “hot swap transceiver” support—you can add, replace, or change the type of any of the transceivers that you use in the SFP+ module ports, without having to first remove the module, and without having to shut down the switch.

Standards adherence:

- IEEE 802.3ak CX4
- IEEE 802.3ae XAUI

Note

The a1 modules are not “Hot-swappable”.

Switch Features

The features of the 2910al Switch include:

- 24 or 48 auto-sensing 10/100/1000Base-T RJ-45 ports with Auto-MDIX.
- Four dual-personality ports—either the auto sensing 10/100/1000Base-T RJ-45 or the mini-GBIC can be used for each port.
- Two slots (optional al module slot) are provided in the back of the device to support a series of transceivers to provide connectivity to other switch boxes, to a 10 Gigabit concentrator or to any Ethernet compatible uplink.
- An auxiliary (USB) port for processing a USB command file.
- The Switches can be connected to a ProCurve RPS/EPS and receive redundant power from that unit. If the internal power supply in the switch fails, the RPS/EPS unit will immediately provide all the power necessary to keep the switch running.
- Plug-and-play networking—all ports are enabled—just connect the network cables to active network devices and your switched network is operational.
- IEEE 802.3ab Auto MDIX on all 10/100/1000 twisted-pair ports, meaning that **all connections can be made using straight-through twisted-pair cables**. Cross-over cables are not required, although they will also work. The pin operation of each port is automatically adjusted for the attached device: if the switch detects that another switch or hub is connected to the port, it configures the port as MDI; if the switch detects that an end-node device is connected to the port, it configures the port as MDI-X. If both devices use Auto-MDIX, the configuration is randomly selected.
- Automatic learning of the network addresses in each switch's 2048-address forwarding table, (with configurable address aging value).
- Automatically negotiated full-duplex operation for the 10/100/1000 RJ-45 ports when connected to other auto-negotiating devices—the mini-GBIC ports always operate at full duplex.
- Easy management of the switch through several available interfaces:
 - **console interface**—a full featured, easy to use, VT-100 terminal interface that is especially good for out-of-band switch management or for Telnet access to the switch.
 - **web browser interface**—an easy to use built-in graphical interface that can be accessed from common web browsers.

- **ProCurve Manager**—an SNMP-based, graphical network management tool that you can use to manage your entire network. This product is included with your new switch.
 - Support for the Spanning Tree Protocol to eliminate network loops
 - Support for up to 256 IEEE 802.1Q-compliant VLANs so you can divide the attached end nodes into logical groupings that fit your business needs.
 - Support for many advanced features to enhance network performance—for a description, see the *Management and Configuration Guide*, which is on the ProCurve Web site www.hp.com/go/procurve/manuals.
 - Download of new switch software for product enhancements or bug fixes.
 - Support for IEEE 802.3af and 802.3at standard and Pre-standard PoE and PoE+ devices.
 - Support for SFP+ transceivers at 10-GbE speed.

Installing the Switch

The HP ProCurve 2910al Switches come with an accessory kit that includes the brackets for mounting the switch in a standard 19-inch telco rack, in an equipment cabinet, and with rubber feet that can be attached so the switch can be securely located on a horizontal surface. The brackets are designed to allow mounting the switch in a variety of locations and orientations. For other mounting options contact your local ProCurve authorized network reseller or ProCurve representative. This chapter shows how to install the switch.

Caution

If the switch is to be shipped in a rack, be sure to use only an HP 10K rack. Mount the switch using rail kit, ProCurve 1U RK MT SWITCH 10K ALL, part number 356578-B21 and shelf kit AB469A, HP rx 16/26 Factory Rackmount Shelf Kit. Both kits must be used. Otherwise you will void the warranty.

Included Parts

The 2910al Switches have the following components shipped with them:

- *HP ProCurve Switch Quick Setup* guide
- *HP ProCurve Switches General Safety and Regulatory Information* booklet
- *2910al Switch Specific Safety and Regulatory Information* sheet
- *Read Me First*
- Customer Support/Warranty booklet
- Console cable (5188-3836)

■ Accessory kit

(5069-5705)

two mounting brackets

eight 8-mm M4 screws to attach the
mounting brackets to the switch

four 5/8-inch number 12-24 screws to
attach the switch to a rack

four rubber feet

■ Power cord, one of the following:

Non-PoE Switches

Australia/New Zealand	8121-0828
China	8121-0829
Continental Europe	8120-0823
Denmark	8120-0826
Japan	8120-4753
Switzerland	8120-0827
United Kingdom/Hong Kong/Singapore	8120-0824
South Africa and India	8120-0919
Thailand and Brazil	8121-0673
Taiwan	8121-0965
Israel	8121-1035
United States/Canada/Mexico	8121-0822

PoE+ Switches

Australia/New Zealand	8121-0857
China	8121-1034
Continental Europe	8120-5336
Denmark	8120-5340
Japan	8120-5342
Switzerland	8120-5339
United Kingdom/Hong Kong/Singapore	8120-5334
South Africa and India	8120-5341
Thailand and Brazil	8121-0671
Taiwan	8121-0967
Israel	8121-1009
United States/Canada/Mexico	8121-0973

**Japan Power
Cord Warning**

製品には、同梱された電源コードをお使い下さい。
同梱された電源コードは、他の製品では使用出来ません。

Installation Precautions:

Follow these precautions when installing the 2910al Switches.

WARNING

- **The rack or cabinet should be adequately secured to prevent it from becoming unstable and/or falling over.**
- **Devices installed in a rack or cabinet should be mounted as low as possible, with the heaviest devices at the bottom and progressively lighter devices installed above.**
- **Do not wall mount any of the 2910al Switches.**

Cautions

- If the switch is to be shipped in a rack, be sure to use only an HP 10K rack. Mount the switch using rail kit part number 356578-B21 and shelf kit AB469A. Both kits must be used. Otherwise you will void the warranty.
- Ensure the power source circuits are properly grounded, then use the power cord supplied with the switch to connect it to the power source.
- If your installation requires a different power cord than the one supplied with the switch and power supply, be sure the cord is adequately sized for the switch's current requirements. In addition, be sure to use a power cord displaying the mark of the safety agency that defines the regulations for power cords in your country. The mark is your assurance that the power cord can be used safely with the switch and power supply.
- When installing the switch, the AC outlet should be near the switch and should be easily accessible in case the switch must be powered off.
- Ensure the switch does not overload the power circuits, wiring, and over-current protection. To determine the possibility of overloading the supply circuits, add together the ampere ratings of all devices installed on the same circuit as the switch and compare the total with the rating limit for the circuit. The maximum ampere ratings are usually printed on the devices near the AC power connectors.
- Do not install the switch in an environment where the operating ambient temperature might exceed 55°C (131°F)¹.
- Ensure the air flow around the sides of the switch is not restricted. Leave at least 7.6 cm (3 inches) for cooling. See Figure 2-1 for the air flow direction.



Figure 2-1. Air flow direction of the 2910al switch

Installation Procedures

Summary

1. **Prepare the installation site** ([page 2-5](#)). Ensure the physical environment is properly prepared, including having the correct network cabling ready to connect to the switch and having an appropriate location for the switch. See [page 2-3](#) for some installation precautions.
2. **Verify the switch passes self test** ([page 2-5](#)). Plug the switch into a power source and observe that the LEDs on the switch's front panel indicate correct switch operation. When self test is complete, unplug the switch.
3. **(Optional) Install a module** ([page 2-8](#)).
4. **Mount the switch** ([page 2-11](#)). The Switch can be mounted in a 19-inch telco rack, in an equipment cabinet, or on a horizontal surface.
5. **(Optional) Install a transceiver** ([page 2-14](#)). If you have installed a module, you can now install one or two transceivers.
6. **(Optional) Install mini-GBICs and SFPs** ([page 2-16](#)). The switch has four slots for installing mini-GBICs. Depending on where you will mount the switch, it may be easier to install the mini-GBICs first. Mini-GBICs can be installed or removed while the switch is powered on.
7. **Connect power to the switch** ([page 2-18](#)). Once the switch is mounted, plug it into the nearby main power source.

8. **(Optional) Connect an external power supply** (page 2-18). You may wish to use an HP ProCurve external power supply, either the 620 RPS/ EPS or the 630 RPS/ EPS with your 2910-PoE+ switch. To do so you must connect the external power supply using the RPS or EPS cables supplied with these devices.
9. **(Optional) Connect a console to the switch** (page 2-24). You may wish to modify the switch's configuration, for example, to configure an IP address so it can be managed using a web browser, from an SNMP network management station, or through a Telnet session. Configuration changes can be made easily by using the included console cable to connect a PC to the switch's console port.
10. **Connect the network cables** (page 2-27). Using the appropriate network cables, connect the network devices to the switch ports.

At this point, the switch is fully installed. See the rest of this chapter if you need more detailed information on any of these installation steps.

1. Prepare the Installation Site

Cabling Infrastructure - Ensure the cabling infrastructure meets the necessary network requirements. See Appendix C “[Cabling and Technology Information](#)” for more information.

- **Installation Location** - Before installing the switch, plan its location and orientation relative to other devices and equipment:
 - In the front of the switch, leave at least 7.6 cm (3 inches) of space for the twisted-pair and fiber-optic cabling.
 - In the back of the switch, leave at least 3.8 cm (1 1/2 inches) of space for the power cord and other cabling.

2. Verify the Switch Passes Self Test

Before mounting the switch in its network location, you should first verify it is working properly by plugging it into a power source and verifying it passes self test.

1. Connect the power cord supplied with the switch to the power connector on the back of the switch, and then into a properly grounded electrical outlet.



Figure 2-2. Connecting the power cord

Note

These switches do not have a power switch. They are powered on when the power cord is connected to the switch and to a power source. For safety, the power outlet should be located near the switch installation.

The switch automatically adjusts to any voltage between 100-127 and 200-240 volts and either 50 or 60 Hz. No voltage range settings are required.

If your installation requires a different power cord than the one supplied with the switch, be sure to use a power cord displaying the mark of the safety agency that defines the regulations for power cords in your country. The mark is your assurance that the power cord can be used safely with the switch.

2. Check the LEDs on the switch as described below. When the switch is powered on, it performs its diagnostic self test. Self test takes approximately 50 seconds to complete.

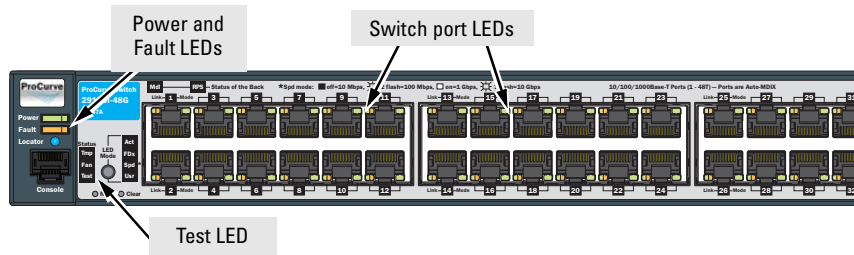

Figure 2-3. Checking the LEDs on the 2910al non-PoE switches

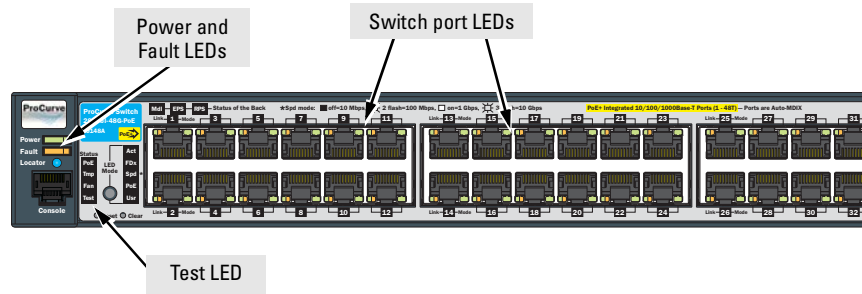

Figure 2-4. Checking the LEDs on the 2910al-PoE+ switches

LED Behavior:

During the self test:

- Initially, all the status, LED Mode and port LEDs are on for most of the duration of the test.
- Most of the LEDs go off and then may come on again during phases of the self test. For the duration of the self test, the Test LED stays on.

When the self test completes successfully:

- The **Power** and **Fan Status** LEDs remain on.
- The **Fault** and **Test LEDs** go off.
- The port LEDs on the front of the switch go into their normal operational mode:
 - If the ports are connected to active network devices, the LEDs behave according to the LED Mode selected. In the default view mode (Link), the LEDs should be on.
 - If the ports are not connected to active network devices, the LEDs will stay off.

If the LED display is different than what is described above, especially if the **Fault** and **Test LEDs** stay on for more than 60 seconds or they start flashing, the self test has not completed correctly. Refer to chapter 4, “Troubleshooting” for diagnostic help.

3. (Optional) Install a Module

Note

The expansional module is “hot pluggable.” You can insert or remove a module while the switch is powered on without interrupting the operation of the rest of the switch ports. If you install or remove an expansional module with the switch powered on, a reboot may be required for the module to be recognized. HP ProCurve recommends inserting or removing modules during scheduled downtime with the switch powered off.

1. Remove the cover plate and save for future use.
2. Insert the module aligning with the guides in the slot.
3. Once the contacts have engaged, use the captive retaining screws to seat the module completely by tightening the screws.
4. Verify the module is installed correctly.

Caution

For proper cooling and reduction of electromagnetic emissions, ensure a slot cover is installed on any unused slot.

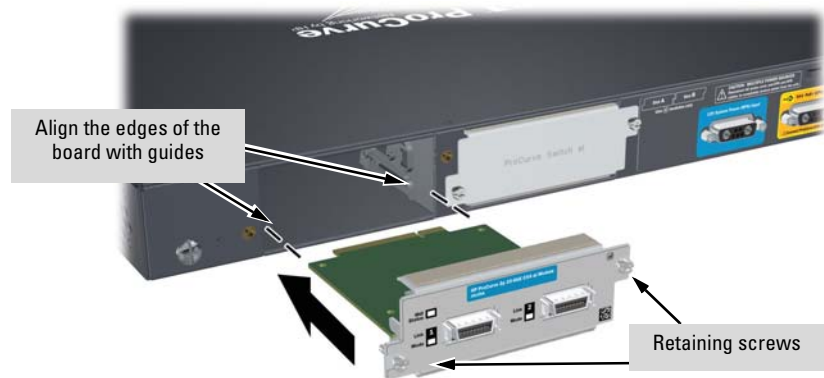

Figure 2-5. Installing a module

Installing the Interconnect Kit

The Interconnect Kit consists of two, 1-port 10 Gigabit switch expansion modules (J9165A) and one 0.5 meter cable used specifically for this interconnect kit. These modules have 1 fixed CX4 port each. The interconnect kit is used for 10-GbE (high speed) connectivity.



Figure 2-6. Example using one Interconnect kit to connect two switches

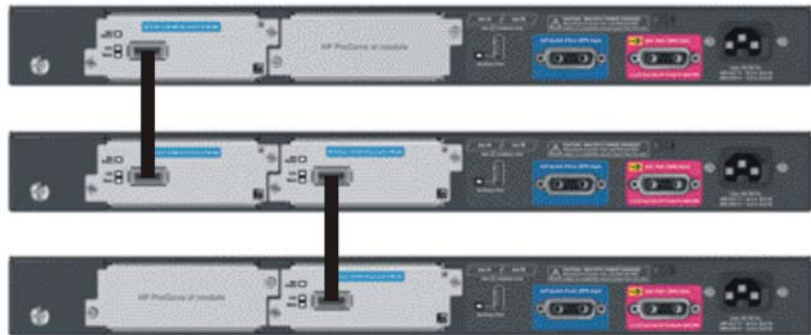

Figure 2-7. Example using two Interconnect kits to connect three switches

Verifying the Module is Installed Correctly

Observe the Module Status and Fault LEDs on the front of the switch to verify the module is installed properly.

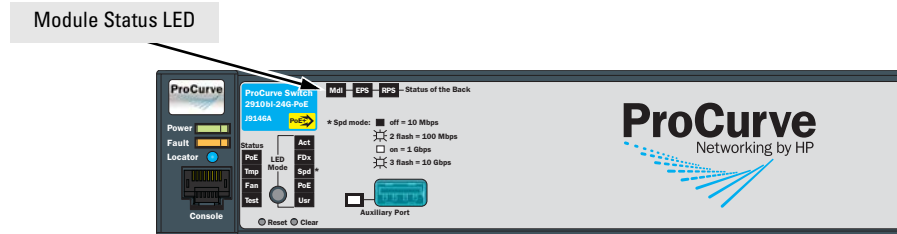

Figure 2-8. Location of Module Status LEDs

When the module is installed properly and the switch is powered on, or the module is installed when the switch already has power, the module undergoes a self test that takes a few seconds. You can use the LEDs to determine that the module is installed properly and has passed the self test, as described in the “LED Behavior” table below.

LED Behavior

LED	Display for a Properly Installed Module
Mdl Status on the front of the switch	The LED goes ON as soon as the module is installed and the switch is powered on, and stays ON steadily.
Fault on the front of the switch	OFF normal state, no fault condition exist.
Mdl Status on the module	The LED goes ON as soon as the module is installed and the switch is powered on, and stays ON steadily.
Link (on the module)	The LED goes ON to indicate the port is enabled, connected and detects a signal from the attached device.
Mode (on the module)	The LED will flicker when traffic is detected on the port and the port is transmitting and/or receiving packets.

4. Mount the Switch

After the switch passes self test, it is ready to be mounted in a stable location. The 2910al Switches can be mounted in these ways:

Mounting Location	Non-PoE Switches	PoE Switches
In a rack or cabinet	Yes	Yes
On a horizontal surface	Yes	Yes
On a wall	No	No

Rack or Cabinet Mounting

The 2910al Switches are designed to be mounted in any EIA-standard 19-inch telco rack or communication equipment cabinet. Note the mounting brackets have multiple mounting holes and can be rotated allowing for a wide variety of mounting options. Secure the rack in accordance with the manufacture's safety guidelines.

WARNING

For safe operation, please read the mounting precautions on [page 2-3](#), before mounting a switch.

Equipment Cabinet Note

The 12-24 screws supplied with the switch are the correct threading for standard EIA/TIA open 19-inch racks. If you are installing the switch in an equipment cabinet such as a server cabinet, use the clips and screws that came with the cabinet in place of the 12-24 screws that are supplied with the switch.

Complete step 1, and plan which four holes you will be using in the cabinet and install all four clips. Then proceed to step 2.

Rack Mounting the Switch

1. Use a #1 Phillips (cross-head) screwdriver and attach the mounting brackets to the switch with the included 8-mm M4 screws. Remember to use the correct accessory kit for your switch, see [page 2-1](#).



Figure 2-9. Attaching mounting brackets

Note

The mounting brackets have multiple mounting holes and can be rotated allowing for a wide variety of mounting options. These include mounting the switch so its front face is flush with the face of the rack, or mounting it in a more balanced position.

2. Hold the switch with attached brackets up to the rack and move it vertically until rack holes line up with the bracket holes, then insert and tighten the four number 12-24 screws holding the brackets to the rack.



Figure 2-10. Mounting in a rack

Horizontal Surface Mounting

Place the switch on a table or other horizontal surface. The switch comes with rubber feet in the accessory kit that can be used to help keep the switch from sliding on the surface.

Attach the rubber feet to the four corners on the bottom of the switch within the embossed angled lines. Use a sturdy surface in an uncluttered area. You may want to secure the networking cables and switch power cord to the table leg or other part of the surface structure to help prevent tripping over the cords.

Caution

Make sure the air flow is not restricted around the sides of the switch. See Figure 2-1 for the air flow direction.

5. (Optional) Install a Transceiver

Note

Hot swapping transceivers is supported. You can install or remove a transceiver with the switch powered on, a reset will not occur. However, rapid hotswaps are not recommended. Wait 5 seconds between hotswaps.

- a. Slide the transceiver in until it stops.
- b. Push firmly until the gasket seats against the bulkhead.



Figure 2-11. Installing a transceiver

Note

When switch power is on, the Link and Activity LEDs will come on for approximately two seconds and then go off. This is confirmation the transceiver is completely seated.

- c. If your transceiver has a bail, move the bail up, if not your transceiver is now completely installed.

To remove the transceiver:

If your transceiver has a bail, lower the bail until it is approximately horizontal, and then using the bail, pull the transceiver from the slot. If your transceiver does not have a bail, pull the transceiver straight out.

Installing or Removing the Optical Media Converter

You can connect an Optical Media Converter (OMC) to the fixed ports only. Use only HP ProCurve OMCs.

Installing the OMC:

1. Connect the OMC to the fixed port.
2. Push it until it clicks.

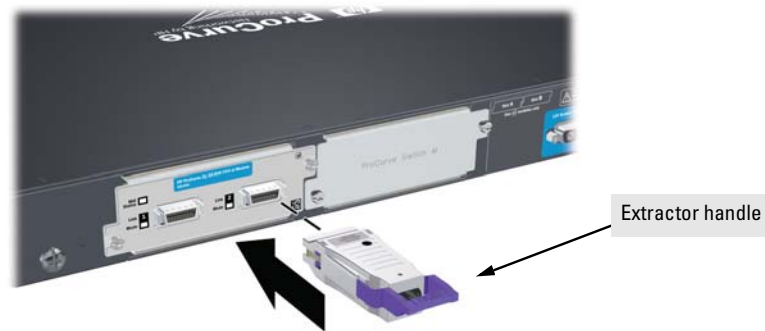

Figure 2-12. Installing an OMC

The OMC has a single bi-color LED to indicate power and link. The LED is orange when the OMC has power but no link. The LED turns green when a link is established.

Removing the OMC:

1. Disconnect the network cable from the OMC before removing it from the module.
2. Grasp the extractor handle and pull straight out.

6. (Optional) Install Mini-GBICs and SFPs

You can install or remove a mini-GBIC from a mini-GBIC slot without having to power off the switch. Use only ProCurve mini-GBICs.

When a mini-GBIC or SFP transceiver is inserted the switch authenticates it. This can take 1-3 seconds, with the worst case being 5 seconds. If the mini-GBIC or SFP transceiver is removed before the authentication completes a self test failure will be reported.

Caution

Use only supported genuine ProCurve mini-GBICs with your switch. Non-ProCurve mini-GBICs are not supported, and their use may result in product malfunction. Should you require additional ProCurve mini-GBICs, contact your ProCurve Networking Sales and Service Office or authorized dealer.

Notes

- Hot swapping mini-GBICs and transceivers is supported. You can install or remove a transceiver with the switch powered on, a reset will not occur. However, rapid hotswaps are not recommended. Wait 5 seconds between Hotswaps.
 - Each of the four mini-GBIC slots is shared with the associated 10/100/1000Base-T RJ-45 port. If a mini-GBIC is installed in a slot, the associated RJ-45 port is disabled.
 - The mini-GBIC ports operate only at full duplex. Half duplex operation is not supported.
 - Inserting a 10-GbE transceiver (SFP+) into a 1 gigabit (mini-GBIC) slot, will generate an event log message, “Transceiver type not supported by this port”, and the transceiver will not function. The reverse is true also, inserting a 1 gigabit (mini-GBIC) transceiver into a 10-GbE slot will generate an event log message and the transceiver will not function.
 - Ensure the network cable is NOT connected when you install or remove a mini-GBIC unless you are using a Direct Attach Cable (DAC).
-

Note

Direct Attach Cables (DACs) are low-cost 10-GbE connectivity options consisting of a one, three, or seven meter cable with SFP+ connectors permanently attached to each end.



Figure 2-13. One meter DAC

Installing the mini-GBICs

Hold the mini-GBIC by its sides and gently insert it into one of the slots on the switch until the mini-GBIC clicks into place.



Figure 2-14. Installing a Mini-GBIC or SFP

WARNING

The ProCurve mini-GBICs are Class 1 laser devices. Avoid direct eye exposure to the beam coming from the transmit port.

Removing the mini-GBICs

Note

You should disconnect the network cable from the mini-GBIC before removing it from the switch.

Depending on when you purchased your ProCurve mini-GBIC, it may have either of three different release mechanisms: a plastic tab on the bottom of the mini-GBIC, a plastic collar around the mini-GBIC, or a wire bail.

To remove the mini-GBICs that have the plastic tab or plastic collar, push the tab or collar toward the switch until you see the mini-GBIC release from the switch (you can see it move outward slightly), and then pull it from the slot.

To remove the mini-GBICs that have the wire bail, lower the bail until it is approximately horizontal, and then using the bail, pull the mini-GBIC from the slot.

7. Connect the Switch to a Power Source

1. Plug the included power cord into the switch's power connector and into a nearby AC power source.
2. Re-check the LEDs during self test. See "LED Behavior" on [page 2-7](#). Also check the LEDs for any accessories you may have installed.

8. (Optional) Connect an External Power Supply

The 2910al Switches support two types of external power supplies:

- The J8696A, HP ProCurve 620 Redundant and External Power Supply (620 RPS/EPS) for RPS power only. The 2910al switches support the RPS or the redundant portion of the 620 RPS/EPS. Redundant power to one of up to two switches can be supplied to back up the internal switch power supply in case of the internal power supply fails. If it should fail, power will be supplied from the 620 RPS/EPS.
- The J9443A, HP ProCurve 630 Redundant and/or External Power Supply (HP ProCurve 630 RPS/EPS) for RPS and EPS power. The 2910al switches support both the RPS and the EPS of the HP ProCurve 630 RPS/EPS.

These external power supplies are unmanaged power supplies that only provide information by way of the LEDs.

RPS Operation

The RPS portion of the 620 RPS/EPS and the HP ProCurve 630 RPS/EPS monitors the power signal from the switch by detecting that either the 620 RPS/EPS or HP ProCurve 630 RPS/EPS is connected to a switch with an RPS cable. When the power from the switch is no longer detected, the external power supply will provide power to the switch within 1 millisecond. AC power must be provided to the switch prior to the RPS being able to provide power. Software will enable RPS capability, thus boot must be complete.

These external power supplies support hot plugging of the RPS cable without causing a reboot of the switch or causing the power supply in either of the power supplies, or switch to shut down temporarily or permanently. For more information refer to the documentation for the external power supplies located on the ProCurve Web site at www.hp.com/go/procurve/manuals.

Operating Characteristics of the 620 RPS/EPS (J8696A)

The 620 RPS/EPS has two RPS ports, each of which can provide redundant +12V power to a connected switch. If a switch with no AC power is connected to an operating 620 RPS/EPS, the switch will not power on. For the switch to receive power from the external power supply, the switch must first be powered up then connected to the external power supply.

For redundant AC power, connect the 620 RPS/EPS to the switch using one of the supplied RPS cables. RPS cables are 2 meters (6.56 feet) in length.

The 620 RPS/EPS also has two EPS Ports which can not be used with the 2910al Switches.

620 RPS/EPS LEDs

The 620 RPS/EPS LEDs are located on the front and back of the device. The following illustration shows an example of the back of the 620 RPS/EPS. There are two dual colored (green/orange) LEDs for each RPS and EPS port:

- Device Connected
- Power Status

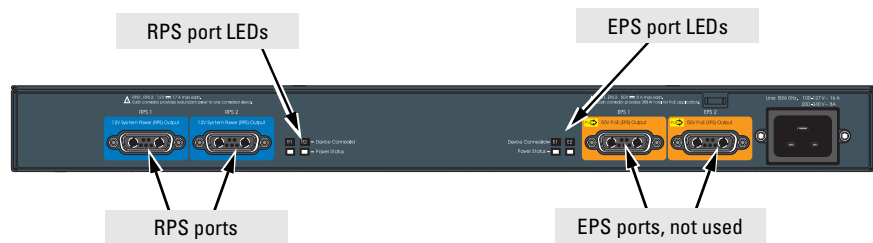

Figure 2-15. Back of 620 RPS/EPS

Table 2-1. 620 RPS/EPS LEDs

LED	State	Meaning
Power (green)	On	The unit is powered on.
	Off	The unit is NOT powered on.
Fault (orange)	Off	The normal state; indicates that there are no fault conditions on the unit.
	Flash orange ^{1,3}	A fault has occurred on the unit, one of the ports, or the fan. The Status LED for the component with the fault will flash simultaneously.
	On	On briefly after the unit is powered on or reset, at the beginning of unit self test. If this LED is on for a prolonged time, the unit has encountered a fatal hardware failure, or has failed its self test.
Temp Status (green and orange)	On	The temperature of the unit is within specification.
	Flash orange ²	One of these conditions exists: <ul style="list-style-type: none"> • A cooling fan has failed. The unit Fault LED and Fan Status LED will be flashing simultaneously. • There is an over temperature condition in the unit. The unit Fault LED is off.
Fan Status (green and orange)	On	The cooling fans are operating normally.
	Flash orange ¹	A cooling fan has failed. The unit Fault LED will be flashing simultaneously.
Port Status (also on back panel of the 620 RPS/EPS)		
Device Connected (green – over-laid with the port number)	On	There is a valid connection to a device.
	Off	There is no valid device connected to the port.
Power Status (green and orange)	On	The unit is supplying power to a connected device.
	Off	One of these conditions exists: <ul style="list-style-type: none"> • There is no connected device. • A connected RPS device does not require power. • A connected EPS device has not successfully communicated for EPS power.
	Flash orange ¹	One of these conditions exists: <ul style="list-style-type: none"> • On the 620 RPS/EPS, RPS power is not available to the connected device because there is a hardware or power supply failure in the 620 RPS/EPS unit. • When the LED is flashing simultaneously with the Fault LED, there is a fault condition on the port.
¹ The flashing behavior is an on/off cycle once every 1.6 seconds, approximately. ² The flashing behavior is an on/off cycle once every 0.8 seconds, approximately. ³ Specific fault conditions can be viewed by checking switch log files.		

620 RPS/EPS Connectivity

This section shows some recommended connection topologies using the 620 RPS/EPS. The 620 RPS/EPS can provide backup power support for up to two ProCurve switches. In the illustration below, two ProCurve Switch 2910s are connected to the RPS ports on a 620 RPS/EPS.

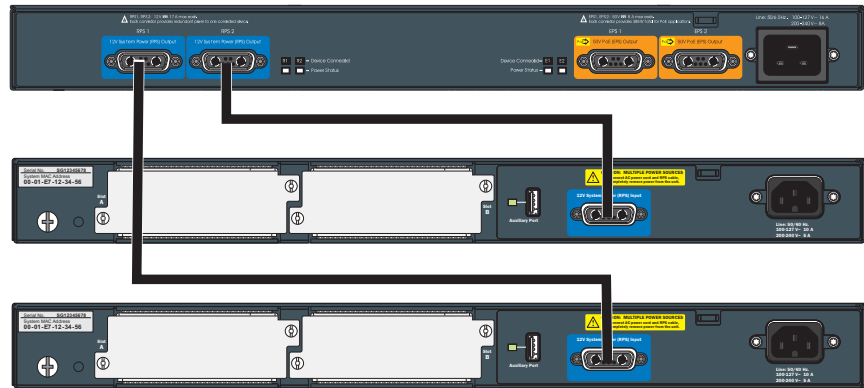

Figure 2-16. Connecting RPS to 2 switches

Operating characteristics of the HP ProCurve 630 RPS/EPS (J9443A)

The HP ProCurve 630 RPS/EPS has one RPS port, which can provide redundant +12V power to a connected switch. If a switch with no AC power is connected to an operating HP ProCurve 630 RPS/EPS, the switch will not power on. For the switch to receive power from the external power supply, the switch must first be powered up then connected to the external power supply. For redundant AC power, connect the HP ProCurve 630 RPS/EPS to the switch using the supplied RPS cable. The RPS cable is 2 meters (6.56 feet) in length.

The HP ProCurve 630 RPS/EPS also has one EPS Port which can supply backup or extra PoE+ power at 54V to the 2910a Switch.

HP ProCurve 630 RPS/EPS LEDs

The HP ProCurve 630 RPS/EPS LEDs are located on the front and back of the device. The following illustration shows an example of the back of the HP ProCurve 630 RPS/EPS. There are two dual colored (green/orange) LEDs for each RPS and EPS port:

- Device Connected
- Power Status

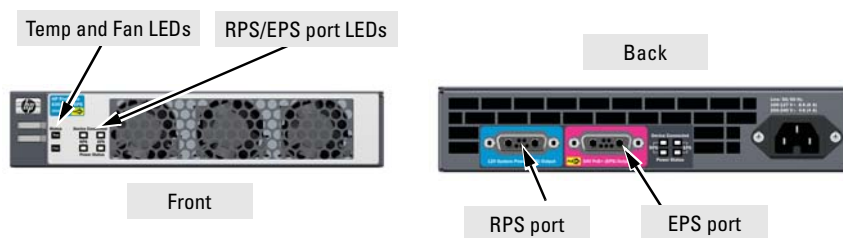

Figure 2-17. Front and Back of HP ProCurve 630 RPS/EPS

Table 2-2. HP ProCurve 630 RPS/EPS LEDs

LED	State	Meaning
Power (green)	On	The unit is powered on.
	Off	The unit is NOT powered on.
Fault (orange)	Off	The normal state; indicates that there are no fault conditions on the unit.
	Flash orange ^{1,3}	A fault has occurred on the unit, one of the ports, or the fan. The Status LED for the component with the fault will flash simultaneously.
	On	On briefly after the unit is powered on or reset, at the beginning of unit self test. If this LED is on for a prolonged time, the unit has encountered a fatal hardware failure, or has failed its self test.
Temp Status (green and orange)	On	The temperature of the unit is within specification.
	Flash orange ²	One of these conditions exists: <ul style="list-style-type: none"> • A cooling fan has failed. The unit Fault LED and Fan Status LED will be flashing simultaneously. • There is an over temperature condition in the unit. The unit Fault LED is off.
Fan Status (green and orange)	On	The cooling fans are operating normally.
	Flash orange ¹	A cooling fan has failed. The unit Fault LED will be flashing simultaneously.
Port Status (also on back panel of the HP ProCurve 630 RPS/EPS)		
Device Connected (green – over-laid with the port number)	On	There is a valid connection to a device.
	Off	There is no valid device connected to the port.
Power Status (green and orange)	On	The unit is supplying power to a connected device.
	Off	One of these conditions exists: <ul style="list-style-type: none"> • There is no connected device. • A connected RPS device does not require power. • A connected EPS device has not successfully communicated for EPS power.
	Flash orange ¹	One of these conditions exists: <ul style="list-style-type: none"> • On the HP ProCurve 630 RPS/EPS, RPS power is not available to the connected device because there is a hardware or power supply failure in the HP ProCurve 630 RPS/EPS unit. • When the LED is flashing simultaneously with the Fault LED, there is a fault condition on the port.
¹ The flashing behavior is an on/off cycle once every 1.6 seconds, approximately. ² The flashing behavior is an on/off cycle once every 0.8 seconds, approximately. ³ Specific fault conditions can be viewed by checking switch log files.		

HP ProCurve 630 RPS/EPS Connectivity

This section shows the recommended connection topology using the HP ProCurve 630 RPS/EPS. The HP ProCurve 630 RPS/EPS can provide backup power support for only one ProCurve switch. In the illustration below, the ProCurve Switch 2910 is connected to the RPS and EPS ports on a HP ProCurve 630 RPS/EPS.

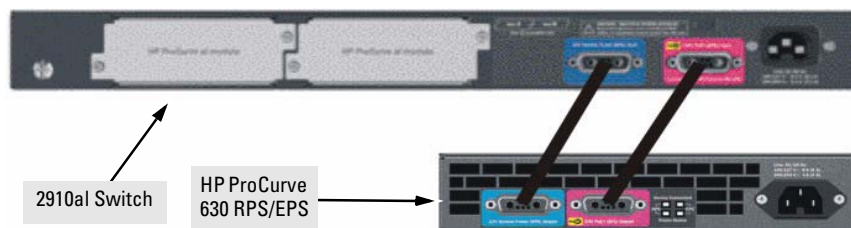

Figure 2-18. Connecting RPS/EPS to a switch

9. (Optional) Connect a Console to the Switch

The switch has a full-featured, easy to use console interface for performing switch management tasks including the following:

- monitor switch and port status and observe network activity statistics
- modify the switch's configuration to optimize switch performance, enhance network traffic control, and improve network security
- read the event log and access diagnostic tools to help in troubleshooting
- download new software to the switch
- add passwords to control access to the switch from the console, web browser interface, and network management stations

The console can be accessed through these methods:

- **Out-of-band:** The switch comes with a serial cable for connecting a PC or VT-100 terminal, to be used as a console, directly to the switch.
- **In-Band:** Access the console using Telnet from a PC or UNIX station on the network, and a VT-100 terminal emulator. This method requires that you first configure the switch with an IP address and subnet mask by using either out-of-band console access or through DHCP/Bootp. For more information on IP addressing and on starting a Telnet session, see chapter 3, *"Getting Started With Switch Configuration"*, and the *Management and Configuration Guide*, which is on the HP ProCurve Web site at www.hp.com/go/procurve/manuals.

The Switch can simultaneously support one out-of-band console session through the Console Port and one in-band Telnet console session.

Terminal Configuration

To connect a console to the switch, configure the PC terminal emulator as a DEC VT-100 (ANSI) terminal or use a VT-100 terminal, and configure either one to operate with these settings:

- any baud rate from 1200 to 115200 (the switch senses the speed)
- 8 data bits, 1 stop bit, no parity, and flow control set to Xon/Xoff
- for the Windows Terminal program, also disable (uncheck) the “Use Function, Arrow, and Ctrl Keys for Windows” option
- for the Hilgraeve HyperTerminal program, select the “Terminal keys” option for the “Function, Arrow, and Ctrl Keys act as” parameter

If you want to operate the console using a different configuration, make sure you change the settings on both the terminal and on the switch so they are compatible. Change the switch settings first, save your changes, then change the terminal settings, then reboot the switch and reestablish the console session.

Direct Console Access

To connect a console to the switch, follow these steps:

1. Connect the PC or terminal to the switch’s Console Port using the console cable included with the Switch. (If your PC or terminal has a 25-pin serial connector, first attach a 9-pin to 25-pin straight-through adapter at one end of the console cable.)
2. Turn on the terminal or PC’s power and, if using a PC, start the PC terminal program.
3. Press **[Enter]** two or three times and you will see the copyright page and the message “Press any key to continue”. Press a key, and you will then see the switch console command (CLI) prompt, for example:

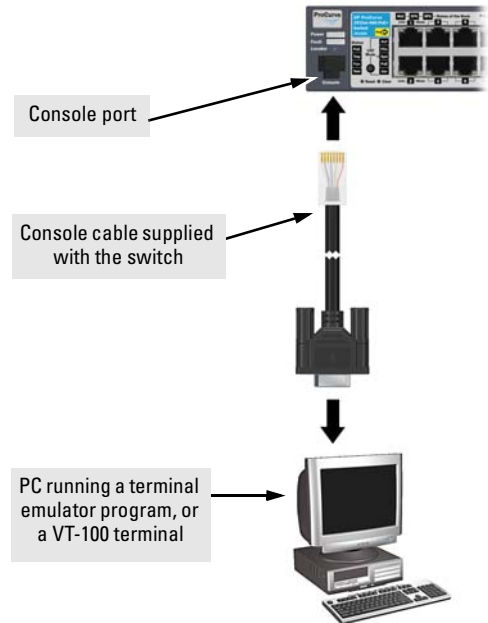

Figure 2-19. Connecting the console cable.

If you want to continue with console management of the switch at this time, see chapter 3, *“Getting Started With Switch Configuration”* for some basic configuration steps. For more detailed information, refer to the *Management and Configuration Guide*, which is on the ProCurve Website at www.hp.com/go/procurve/manuals.

Console Cable Pinouts

The console cable has an RJ-45 plug on one end and a DB-9 female connector on the other end. Table 2-19 describes the mapping of the RJ-45 to DB-9 pins.

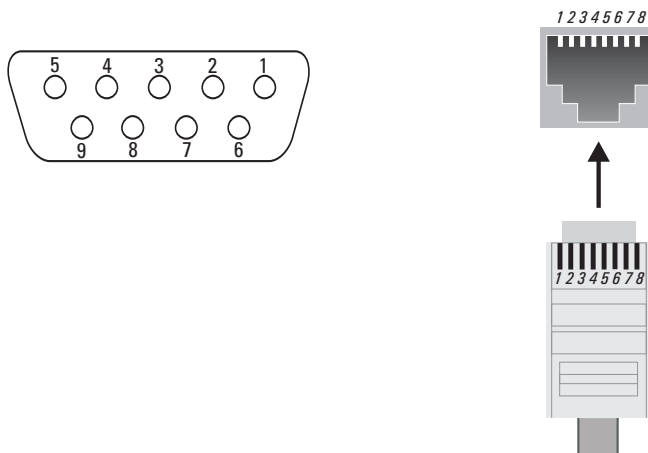

Figure 2-20. RJ-45 to DB-9 pinouts

Table 2-3. Mapping of RJ-45 to DB-9

RJ-45 (Signal reference from Chassis)		DB-9 (Signal reference from PC)	
Reserved	1	8	CTS
Reserved	2	6	DSR
TXD	3	2	RXD
Reserved	4	1	DCD
GND	5	5	GND
RXD	6	3	TXD
Reserved	7	4	DTR
Reserved	8	7	RTS
		9	RI

10. Connect the Network Cables

Connect the network cables, described under “Cabling Infrastructure” (page 2-5), from the network devices or your patch panels to the fixed RJ-45 ports on the switch or to any mini-GBICs you have installed in the switch.

Using the RJ-45 Connectors

To connect:

Push the RJ-45 plug into the RJ-45 jack until the tab on the plug clicks into place. When power is on for the switch and for the connected device, the Link LED for the port should light to confirm a powered-on device (for example, an end node) is at the other end of the cable.

If the Link LED does *not* go on when the network cable is connected to the port, see “[Diagnosing with the LEDs](#)” on page 4-4, in chapter 5, “Troubleshooting”.

To disconnect:

Press the small tab on the plug and pull the plug out of the jack.

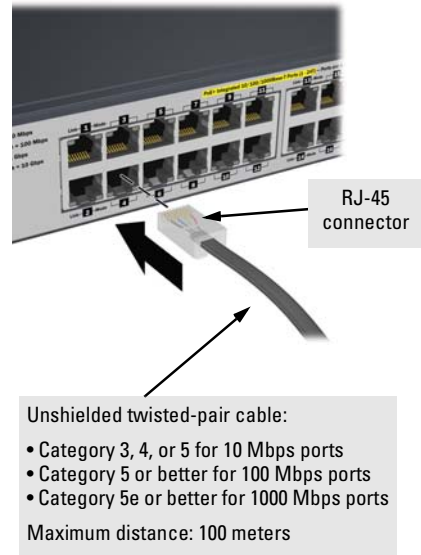

Connecting Cables to mini-GBICs

Note

Each of the four mini-GBIC slots is shared with the associated 10/100/1000Base-T RJ-45 port. If a mini-GBIC is installed in a slot, the associated RJ-45 port is disabled.

If you have any mini-GBICs installed in the switch, the type of network connections you will need to use depends on the type of mini-GBICs you have installed. See Appendix C “[Cabling and Technology Information](#)” for more information, for the mini-GBIC cabling information.

For mini-GBICs ports, and in general for all the switch ports, when a network cable from an active network device is connected to the port, the port LED for that port should go on. If the port LED does *not* go on when the network cable is connected to the port, see “[Diagnosing with the LEDs](#)” on page 4-4 in chapter 5, “Troubleshooting”.

Connecting a fiber cable

To connect:

1. Remove the dust covers from the cable connectors and the port.
2. Aligning the notches on the cable connectors with the slots of the port, press the cable connector into the port until it snaps into place.

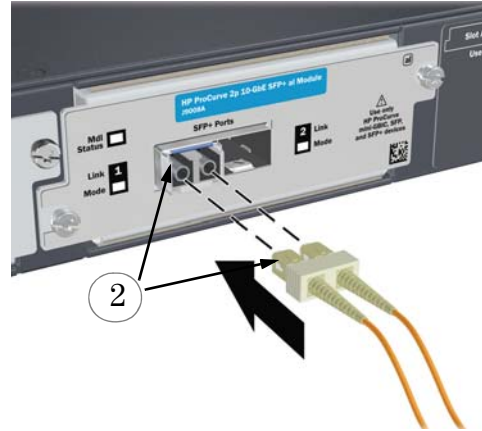

If the Link LED does *not* go on when the network cable is connected to the port, see [“Diagnosing with the LEDs” on page 4-4](#), in chapter 5, “Troubleshooting”.

To disconnect:

Pull the cable connector straight out.

Connecting a copper cable

To connect:

1. Push the copper cable connector into the copper port. Ensure the locking device locks the cable connector into place.

To disconnect:

Pull the cable connector straight out.



When a network cable from an active network device is connected to the port, the port LED for that port should go on. If the port LED does *not* go on when the network cable is connected to the port, see [“Diagnosing with the LEDs” on page 4-4](#) in chapter 5, “Troubleshooting”.

Sample Network Topologies

This section shows a few sample network topologies in which the switch is implemented. For more topology information, see the ProCurve network products Website, www.hp.com/go/procurve.

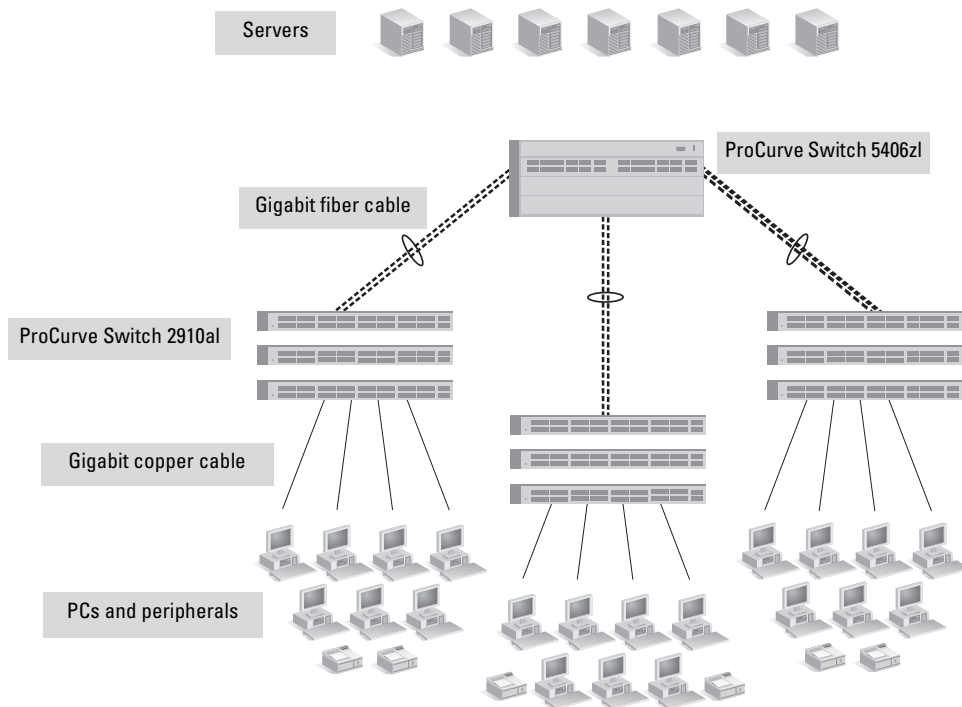

Figure 2-21. Example, gigabit edge deployment

The Switch 2910al can be used at the edge of the network to which end nodes, printers and other peripherals, are directly connected, as shown in the above illustration. Notice that the end node devices are connected to the switch by gigabit copper cable, straight-through or crossover twisted-pair cables.

Installing the Switch

Sample Network Topologies

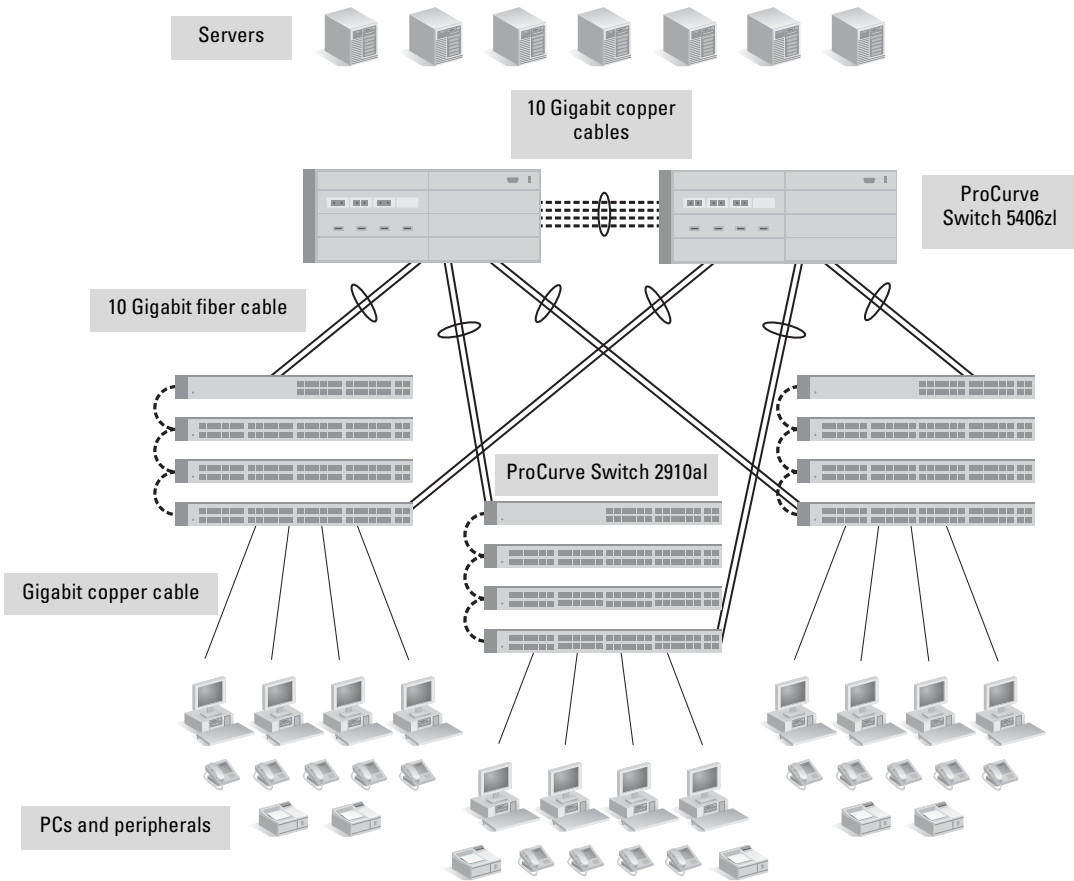

Figure 2-22. Example, high performance edge deployment

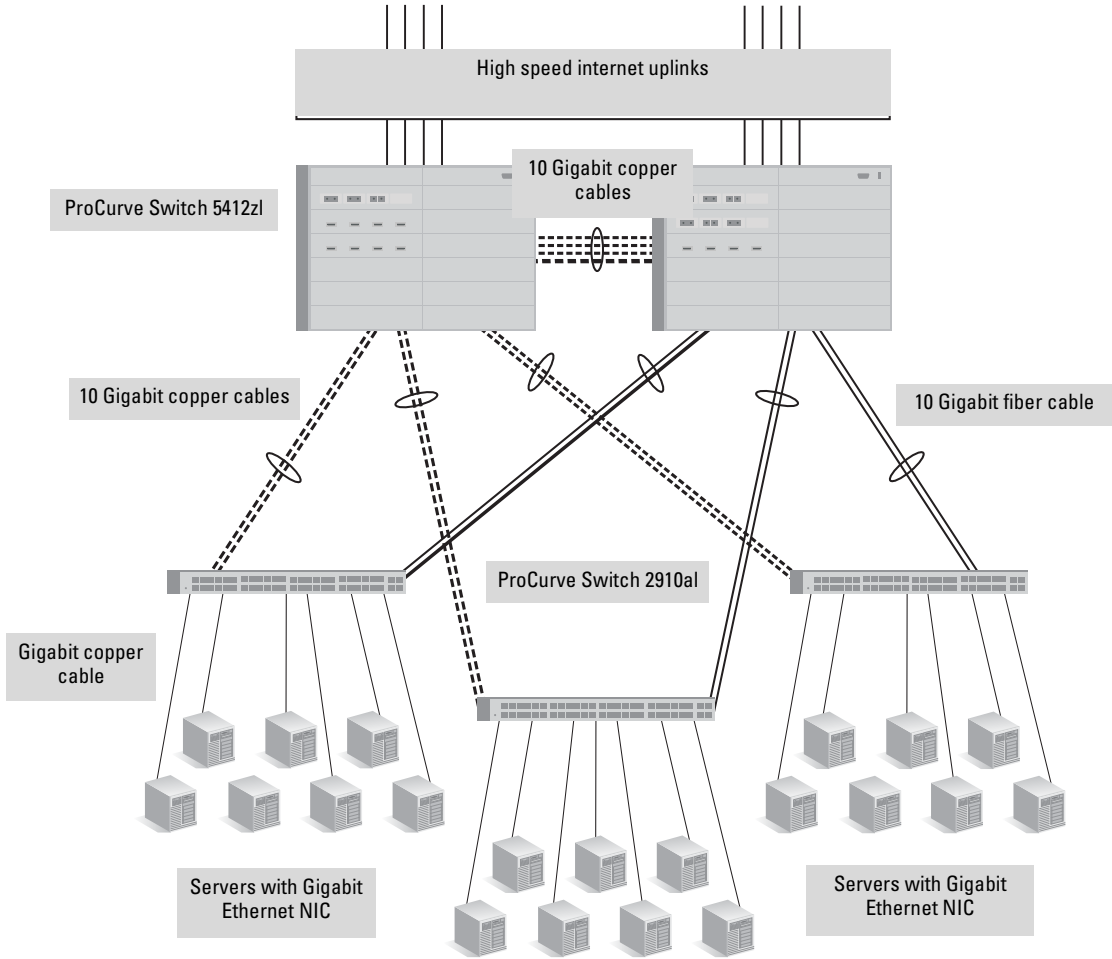

Figure 2-23. Example, server farm deployment

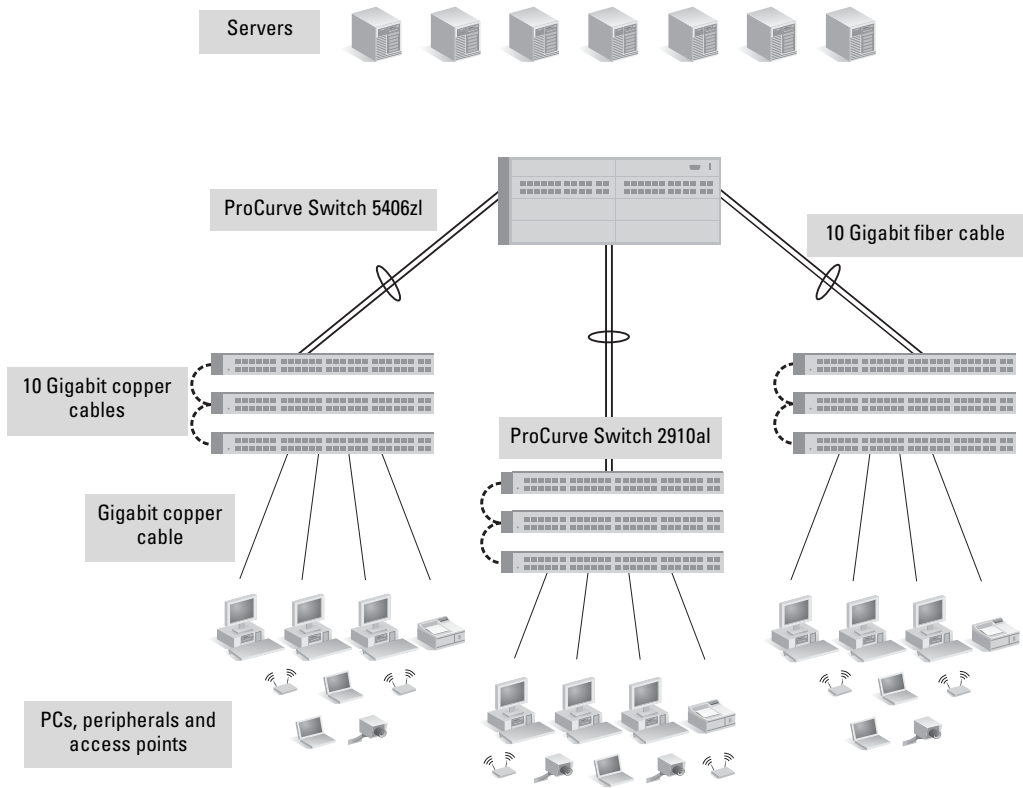

Figure 2-24. Example, PoE edge deployment

Getting Started With Switch Configuration

This chapter is a guide for using the console Switch Setup screen to quickly assign an IP (Internet Protocol) address and subnet mask to the switch, set a Manager password, and, optionally, configure other basic features.

For more information on using the switch console and the other switch management interfaces: the web browser interface and the SNMP management tool, ProCurve Manager, please see the *Management and Configuration Guide*, which is on the ProCurve Website at www.hp.com/go/procurve/manuals.

Recommended Minimal Configuration

In the factory default configuration, the switch has no IP (Internet Protocol) address and subnet mask, and no passwords. In this state, it can be managed only through a direct console connection. To manage the switch through in-band (networked) access, you should configure the switch with an IP address and subnet mask compatible with your network. Also, you should configure a Manager password to control access privileges from the console and web browser interface. Other parameters in the Switch Setup screen can be left at their default settings or you can configure them with values you enter.

Many other features can be configured through the switch's console interface, to optimize the switch's performance, to enhance your control of the network traffic, and to improve network security. Once an IP address has been configured on the switch, these features can be accessed more conveniently through a remote Telnet session, through the switch's web browser interface, and from an SNMP network management station running a network management program, such as ProCurve Manager. For a listing of switch features available with and without an IP address, refer to "How IP Addressing Affects Switch Operation" in the *Management and Configuration Guide*, which is on the ProCurve Website at www.hp.com/go/procurve/manuals.

For more information on IP addressing, refer to "IP Configuration" in the *Management and Configuration Guide*.

Note

By default, the switch is configured to acquire an IP address configuration from a DHCP or Bootp server. To use DHCP/Bootp instead of the manual method described in this chapter, see “DHCP/Bootp Operation” in the *Management and Configuration Guide*, which is on the ProCurve Website at www.hp.com/go/procurve/manuals.

Using the Console Setup Screen

The quickest and easiest way to minimally configure the switch for management and password protection in your network is to use a direct console connection to the switch, start a console session, and access the Switch Setup screen.

1. Using the method described in the preceding section, connect a terminal device to the switch and display the switch console command (CLI) prompt (the default display).

The CLI prompt appears displaying the switch model number:

```
ProCurve Switch 2910a1-48G#
```

2. At the prompt, enter the **setup** command to display the Switch Setup screen. The following illustration shows the Setup screen with the default settings.

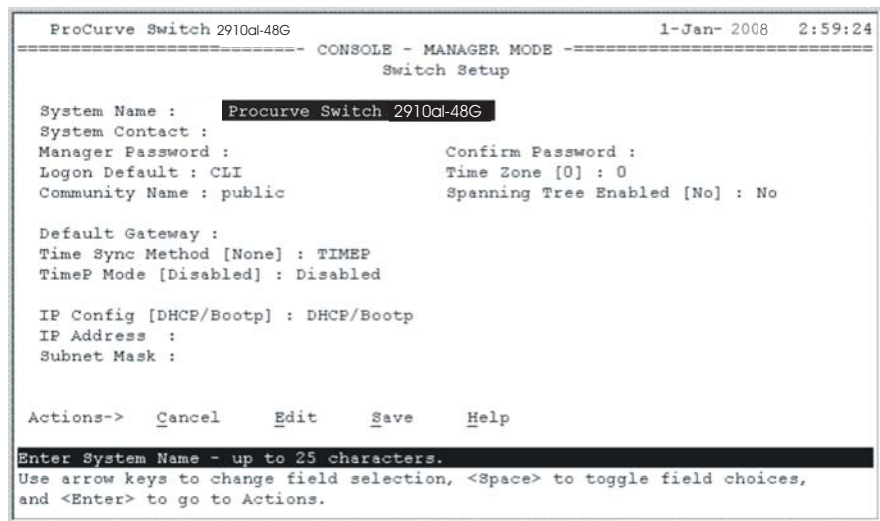

```
ProCurve Switch 2910a1-48G 1-Jan-2008 2:59:24
----- CONSOLE - MANAGER MODE -----
                          Switch Setup

System Name : Procurve Switch 2910a1-48G
System Contact :
Manager Password :
Logon Default : CLI
Community Name : public
Confirm Password :
Time Zone [0] : 0
Spanning Tree Enabled [No] : No

Default Gateway :
Time Sync Method [None] : TIMEP
TimeP Mode [Disabled] : Disabled

IP Config [DHCP/Bootp] : DHCP/Bootp
IP Address :
Subnet Mask :

Actions->  Cancell  Edit   Save   Help

Enter System Name - up to 25 characters.
Use arrow keys to change field selection, <Space> to toggle field choices,
and <Enter> to go to Actions.
```

3. Use the **[Tab]** key to select the **Manager Password** field and enter a manager password of up to 16 characters.

4. [Tab] to the **IP Config (DHCP/Bootp)** field and use the Space bar to select the **Manual** option.
5. [Tab] to the **IP Address** field and enter the IP address that is compatible with your network.
6. [Tab] to the **Subnet Mask** field and enter the subnet mask used for your network.
7. Press [Enter], then [S] (for **Save**).

Here is some information on the fields in the Setup screen. For more information on these fields, see the *Management and Configuration Guide*, which is on the ProCurve Website at www.hp.com/go/procurve/manuals:

Parameter	Default	
System Name	blank	Optional; up to 25 characters, including spaces
System Contact	blank	Optional; up to 48 characters, including spaces
Manager Password	blank	Recommended; up to 16 characters (no blank spaces)
Logon Default	CLI	The default setting selects the command line interface for console access. The alternative is the menu interface.
Time Zone	0 (none)	Optional; 1440 to -1440. The number of minutes your location is to the West (-) or East (+) of GMT.
Community Name	public	Default setting recommended.
Spanning Tree Enabled	No	Default setting recommended unless STP is already running on your network or the switch will be used in complex network topologies.
Default Gateway	blank	Optional; Enter the IP address of the next-hop gateway node if network traffic needs to be able to reach off-subnet destinations.
Time Sync Method	None	Optional; The protocol the switch uses to acquire a time signal. The options are SNTP and TimeP.
TimeP Mode	Disabled	Optional; The method the switch uses to acquire the TimeP server address.
IP Config (DHCP/Bootp)	DHCP/Bootp	Set to Manual unless a DHCP/Bootp server is used on your network to configure IP addressing.
IP Address	xxx.xxx.xxx.xxx	Recommended; If you set IP Config to Manual, then enter an IP address compatible with your network.
Note: The IP address and subnet mask assigned for the switch must be compatible with the IP addressing used in your network. For more information on IP addressing, see the <i>Management and Configuration Guide</i> , which is on the ProCurve Website at www.hp.com/go/procurve/manuals .		
Subnet Mask	xxx.xxx.xxx.xxx	Recommended; If you entered an IP address, then enter a subnet mask compatible with your network.

Where to Go From Here

The above procedure configures your switch with a Manager password, IP address, and subnet mask. As a result, with the proper network connections, you can now manage the switch from a PC equipped with Telnet, a web browser interface, or from an SNMP-based network management station using a tool such as ProCurve Manager.

Some basic information on managing your switch is included in the next section. For more information on the console, web browser, and SNMP management interfaces and all the features that can be configured on the al switches, see the *Management and Configuration Guide*, which is on the ProCurve Website at www.hp.com/go/procurve/manuals.

To Recover from a Lost Manager Password

If you cannot start a console session at the manager level because of a lost Manager password, you can clear all passwords and user names by getting physical access to the switch and pressing and holding the Clear button for a full second.

Using the IP Address for Remote Switch Management

With your switch, you can use the switch's IP address to manage the switch from any PC that is on the same subnet as the switch. You can use either a Telnet session or a standard web browser to manage the switch.

Starting a Telnet Session

To access the switch through a Telnet session, follow these steps:

1. Make sure the switch is configured with an IP address and that the switch is reachable from the PC that is running the Telnet session (for example, by using a Ping command to the switch's IP address).
2. Start the Telnet program on a PC that is on the same subnet as the switch and connect to the switch's IP address.
3. You will see the copyright page and the message "Press any key to continue". Press a key, and you will then see the switch console command (CLI) prompt, for example:

```
ProCurve Switch 2910a1-48G#
```

Enter **help** or **?** to see a list of commands that can be executed at the prompt. Entering any command followed by **help** provides more detailed context help information about the command. Entering any command followed by **?** displays a list of options that are available at that point in the command entry.

Starting a Web Browser Session

Your Switch can be managed through a graphical interface that you can access from any PC or workstation on the network by running your web browser and typing in the switch's IP address as the URL. No additional software installation is required to make this interface available; it is included in the switch's onboard software.

Getting Started With Switch Configuration
Using the IP Address for Remote Switch Management

The operating systems, web browsers, and Java support required to manage the switch through the browser interface are listed in the following table:

Operating System	Internet Explorer	Java Version
Windows 2000 SP4	5.5 SP2, 6.0 SP1	1.3.1_12 and 1.4.2_05
Windows XP SP1a	6.0 SP1	1.3.1_12 and 1.4.2_05
Windows Server 2003	6.0 SP1	1.3.1_12 and 1.4.2_05

The following illustration shows a typical web browser interface screen.

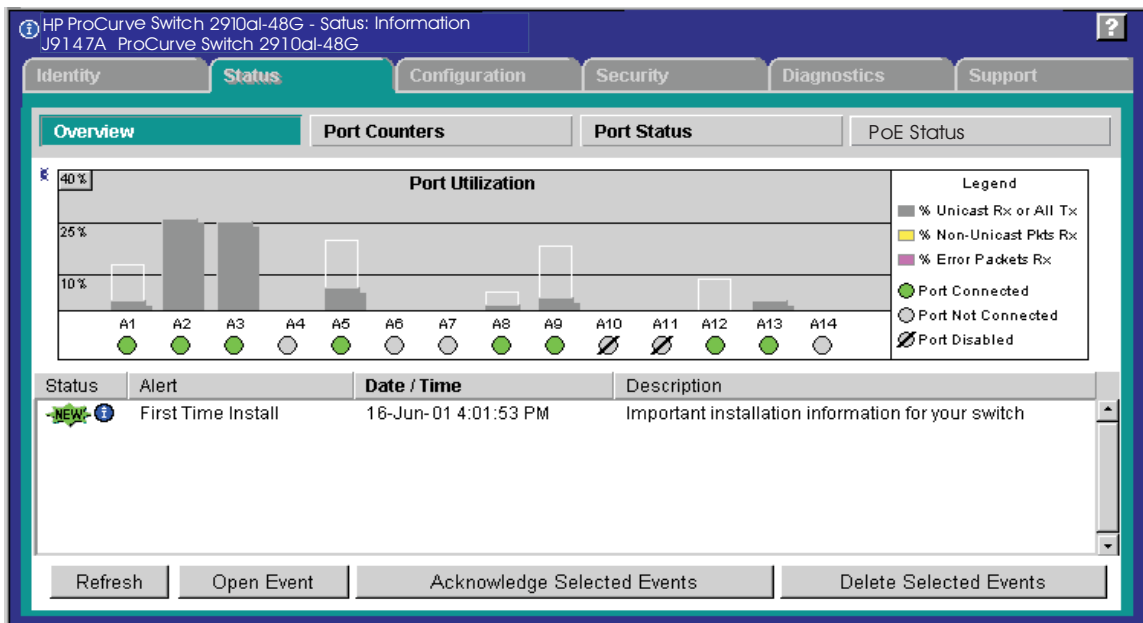

For more information on using the web browser interface, see the *Management and Configuration Guide*, which is on the ProCurve Website at www.hp.com/go/procurve/manuals.

An extensive help system is also available for the web browser interface. To access the help system though, the subnet on which the switch is installed must have access to the internet, or ProCurve Manager needs to be installed on a network management station that is on the subnet.

Troubleshooting

This chapter describes how to troubleshoot your switch. This document describes troubleshooting mostly from a hardware perspective. You can perform more in-depth troubleshooting on the switch using the software tools available with the switch, including the full-featured console interface, the built-in web browser interface, and ProCurve Manager, the SNMP-based network management tool. For more information, see the chapter “Troubleshooting” in the *Management and Configuration Guide*, which is on the ProCurve Website at www.hp.com/go/procurve/manuals.

This chapter describes the following:

- Basic Troubleshooting Tips ([page 4-1](#))
 - Diagnosing with the LEDs ([page 4-4](#))
 - Proactive Networking Tools ([page 4-8](#))
 - Hardware Diagnostic Tests ([page 4-9](#))
 - Restoring the Factory Default Configuration ([page 4-11](#))
 - Downloading New Switch Software ([page 4-12](#))
 - HP Customer Support Services ([page 4-12](#))
-

Basic Troubleshooting Tips

Most problems are caused by the following situations. Check for these items first when starting your troubleshooting:

- **Connecting to devices that have a fixed full-duplex configuration.** The RJ-45 ports are configured as “Auto”. That is, when connecting to attached devices, the switch will operate in one of two ways to determine the link speed and the communication mode (half duplex or full duplex):
 - If the connected device is also configured to Auto, the switch will automatically negotiate both link speed and communication mode.
 - If the connected device has a fixed configuration, for example 100 Mbps, at half or full duplex, the switch will automatically sense the link speed, but will default to a communication mode of *half* duplex.
-

Because the switch behaves in this way (*in compliance with the IEEE 802.3 standard*), if a device connected to the switch has a fixed configuration at *full duplex*, the device will not connect correctly to the switch. The result will be high error rates and very inefficient communications between the switch and the device.

Make sure that all devices connected to the switch are configured to auto negotiate, or are configured to connect at half duplex (all hubs are configured this way, for example).

- **Faulty or loose cables.** Look for loose or obviously faulty connections. If they appear to be OK, make sure the connections are snug. If that does not correct the problem, try a different cable.
- **Non-standard cables.** Non-standard and miswired cables may cause network collisions and other network problems, and can seriously impair network performance. Use a new correctly-wired cable or compare your cable to the cable in appendix B, “Cables and Connectors” for pinouts and correct cable wiring. A category 5 cable tester is a recommended tool for every 100Base-TX and 1000Base-T network installation.
- **Improper Network Topologies.** It is important to make sure you have a valid network topology. Common topology faults include excessive cable length and excessive repeater delays between end nodes. If you have network problems after recent changes to the network, change back to the previous topology. If you no longer experience the problems, the new topology is probably at fault. Sample topologies are shown at the end of chapter 2 in this book, and some topology configuration guidelines can be found online on the ProCurve Website at www.hp.com/go/procurve/manuals.

In addition, you should make sure that your network topology contains **no data path loops**. Between any two end nodes, there should be only one active cabling path at any time. Data path loops will cause broadcast storms that will severely impact your network performance.

For your switch, if you wish to build redundant paths between important nodes in your network to provide some fault tolerance, you should enable **Spanning Tree Protocol** support on the switch. This ensures only one of the redundant paths is active at any time, thus avoiding data path loops. Spanning Tree can be enabled through the switch console, the web browser interface, or ProCurve Manager.

The 2910al Switch devices also support **Trunking**, which allows multiple network cables to be used for a single network connection without causing a data path loop. For more information on Spanning Tree and Trunking, see the *Management and Configuration Guide*, which is on the ProCurve Website at www.hp.com/go/procurve/manuals.

- **Check the port configuration.** A port on your switch may not be operating as you expect because it has been put into a “blocking” state by Spanning Tree, GVRP (automatic VLANs), or LACP (automatic trunking). (Note that the normal operation of the Spanning Tree, GVRP, and LACP features may put the port in a blocking state.) Or, the port just may have been configured as disabled through software.

Use the switch console to determine the port’s configuration and verify that there is not an improper or undesired configuration of any of the switch features that may be affecting the port. For more information, see the *Management and Configuration Guide*, which is on the ProCurve Website at www.hp.com/go/procurve/manuals.

For more information on possible network problems and their solutions, refer to the technical note “Troubleshooting LAN Performance and Intermittent Connectivity Problems”, which can be found on the ProCurve Website, www.hp.com/go/procurve/library, under “T” in the A-Z Index section.

Diagnosing with the LEDs

Table 4-1 shows LED patterns on the switch and the switch modules that indicate problem conditions.

1. Check in the table for the LED pattern you see on your switch.
2. Refer to the corresponding diagnostic tip on the next few pages.

Table 4-1. LED Error Indicators

LED Pattern Indicating Problems								Diag Tips
Power	Fault	Module (Mdl) Status**	RPS Status	EPS Status	Test	Fan Status	Port LED (in Link view mode)	
Off with power cord plugged in	*	*	*		*	*	*	1
On	Prolonged On	*	*		Prolonged On	*	*	2
On	Flashing [†]	*	*		Flashing [†]	*	*	3
On	Flashing [†]	*	*		Off	Flashing [†]	*	4
On	Flashing [†]	See tip 5	*		Flashing [†]	*	Flashing [†]	5
On	Off	*	*		Off	*	Off with cable connected	6
On	Off	*	*		Off	*	On, but the port is not communicating	7
On	Flashing [†]	*	Flashing [†]	*	*	*	*	8
On	Flashing [†]	*	*	Flashing [†]	*	*	*	9
On	Flashing [†]	F ¹ Flashing [†] B ² Flashing [†]	*		Flashing [†]	*	*	10

* This LED is not important for the diagnosis.
[†] The flashing behavior is an on/off cycle once every 1.6 seconds, approximately.
**** The Module Status LED is located on the module in the rear of the switch.**
¹F - Front
²B - Back

Diagnostic Tips:

Tip	Problem	Solution
1	The switch is not plugged into an active AC power source, or the switch's power supply may have failed. The switch will not power up if the top is off.	<ol style="list-style-type: none"> 1. Verify the power cord is plugged into an active power source and to the switch. Make sure these connections are snug. 2. Try power cycling the switch by unplugging and plugging the power cord back in. 3. If the Power LED is still not on, verify that the AC power source works by plugging another device into the outlet. Or try plugging the switch into a different outlet or try a different power cord. <p>If the power source and power cord are OK and this condition persists, the switch power supply may have failed. Call your ProCurve authorized LAN dealer, or use the electronic support services from ProCurve to get assistance. See the Customer Support/Warranty booklet for more information.</p>
2	A switch hardware failure has occurred. All the LEDs will stay on indefinitely.	Try power cycling the switch. If the fault indication reoccurs, the switch may have failed. Call your ProCurve authorized LAN dealer, or use the electronic support services from HP to get assistance. See the Customer Support/Warranty booklet for more information.
3	The switch has experienced a software failure during self test.	<ol style="list-style-type: none"> 1. Try resetting the switch by pressing the Reset button on the front of the switch, or by power cycling the switch. 2. If the fault indication reoccurs, attach a console to the switch (as indicated in chapter 2) and configure it to operate at 9600 baud. Then, reset the switch. Messages should appear on the console screen and in the console log identifying the error condition. You can view the console log at that point by selecting it from the console Main Menu. <p>If necessary to resolve the problem, contact your ProCurve authorized LAN dealer, or use the electronic support services from ProCurve to get assistance. See the Customer Support/Warranty booklet for more information.</p>
4	One or both of the switch cooling fans may have failed.	Try disconnecting power from the switch and wait a few moments. Then reconnect the power to the switch and check the LEDs again. If the error indication reoccurs, one or both of the fans has failed. The switch has two fans and may continue to operate under this condition if the ambient temperature does not exceed normal room temperature, but for best operation, the switch should be replaced. Contact your ProCurve authorized LAN dealer, or use the electronic support services from ProCurve to get assistance. See the Customer Support/Warranty booklet for more information.
5	The network port for which the LED is flashing has experienced a self test or initialization failure. If the Mdl Status LED is flashing, the affected port is on the al Module.	<p>Try power cycling the switch. If the fault indication reoccurs, the switch port may have failed. Call your ProCurve authorized LAN dealer, or use the electronic support services from ProCurve to get assistance. See the Customer Support/Warranty booklet for more information.</p> <p>If the port is a pluggable, verify it is one of the pluggables supported by the switch. Unsupported pluggables will be identified with this fault condition. The supported mini-GBICs are listed in Chapter 2, "Installing the Switch" on page 2-1, supported transceivers are listed in Appendix B, <i>Module Specifications</i>. The mini-GBICs are also tested when they are "hot-swapped"—installed or changed while the switch is powered on.</p> <p>To verify the port has failed, try removing and reinstalling the mini-GBIC without having to power off the switch. If the port fault indication reoccurs, you will have to replace the mini-GBIC.</p>

continued on the next page

Tip	Problem	Solution
⑥	The network connection is not working properly.	<p>Try the following procedures:</p> <ul style="list-style-type: none">• For the indicated port, verify both ends of the cabling, at the switch and the connected device, are connected properly.• Verify the connected device and switch are both powered <i>on</i> and operating correctly.• Verify you have used the correct cable type for the connection:<ul style="list-style-type: none">– For twisted-pair connections to the fixed 10/100 or 10/100/1000 ports, if the port is configured to “Auto” (auto negotiate), either straight-through or crossover cables can be used because of the switch’s “HP Auto-MDIX” feature and the Auto MDI/MDI-X feature of the 10/100/1000-T port. <hr/> <p>Note: <i>If the switch port configuration is changed to one of the fixed configuration options (for example, 100 Mbps/Full Duplex), then the port operates as MDI-X only and you must use the correct type of cable for the connection. In general, for connecting an end node (MDI port) to the switch, use straight-through cable; for connecting to MDI-X ports on hubs, other switches, and routers, use crossover cable.</i></p> <hr/> <ul style="list-style-type: none">– For fiber-optic connections, verify the transmit port on the switch is connected to the receive port on the connected device, and the switch receive port is connected to the transmit port on the connected device.• For the dual-personality 10/100/1000-T ports, be sure a mini-GBIC is not installed in the associated slot.• For 1000Base-T connections, verify that the network cabling complies with the IEEE 802.3ab standard. The cable should be installed according to the ANSI/TIA/EIA-568-A-5 specifications. Cable testing should comply with the stated limitations for Attenuation, Near-End Crosstalk, Far-End Crosstalk, Equal-Level Far-End Crosstalk (ELFEXT), Multiple Disturber ELFEXT, and Return Loss. The cable verification process must include all patch cables from any end devices, including the switch, to any patch panels in the cabling path.• Verify the port has not been disabled through a switch configuration change. You can use the console interface, or, if you have configured an IP address on the switch, use the web browser interface, or ProCurve Manager network management software to determine the state of the port and re-enable the port if necessary.• Verify the switch port configuration matches the configuration of the attached device. For example, if the switch port is configured as “Auto”, the port on the attached device also MUST be configured as “Auto”. Depending on the port type, twisted-pair or fiber-optic, if the configurations don’t match, the results could be a very unreliable connection, or no link at all.• If the other procedures don’t resolve the problem, try using a different port or a different cable.

Tip	Problem	Solution
7	The port may be improperly configured, or the port may be in a “blocking” state by the normal operation of the Spanning Tree, LACP, or IGMP features.	<p>Use the switch console to see if the port is part of a dynamic trunk (through the LACP feature) or to see if Spanning Tree is enabled on the switch, and to see if the port may have been put into a “blocking” state by those features. The show lacp command displays the port status for the LACP feature; the show spanning-tree command displays the port status for Spanning Tree.</p> <p>Also check the Port Status screen using the show interfaces command to see if the port has been configured as “disabled”.</p> <p>Other switch features that may affect the port operation include VLANs and IGMP. Use the switch console to see how the port is configured for these features.</p> <p>For software troubleshooting tips, see the chapter “Troubleshooting” in the <i>Management and Configuration Guide</i>, which is on the ProCurve Website at www.hp.com/go/procurve/manuals.</p> <p>Make sure also, the device at the other end of the connection is indicating a good link to the switch. If it is not, the problem may be with the cabling between the devices or the connectors on the cable.</p>
8	An RPS is connected but the switch has experienced a fault.	<p>Check the RPS unit to make sure it is plugged in to an active power source. If this is ok but the LEDs are still flashing, the power supply in the RPS unit may have failed. Try reversing R1 and R2 power cords on the 620 RPS/EPS. Also check the log files of the connected switch for more information. This condition can also be caused by an RPS unit fan failure or an over temperature condition. If necessary to resolve the problem, contact your ProCurve authorized LAN dealer, or use the electronic support services from ProCurve to get assistance. See the Customer Support/Warranty booklet for more information.</p>
9	An EPS is connected but the switch has experienced a fault.	<p>Check the EPS unit to make sure it is plugged in to an active power source. If this is ok but the LEDs are still flashing, the power supply in the EPS unit may have failed. Try reversing EPS1 and EPS2 power cords on the 620 RPS/EPS. Also check the log files of the connected switch for more information. This condition can also be caused by an RPS unit fan failure or an over temperature condition. If necessary to resolve the problem, contact your ProCurve authorized LAN dealer, or use the electronic support services from ProCurve to get assistance. See the Customer Support/Warranty booklet for more information.</p>
10	Expansion al module is plugged in but has experienced a fault.	<p>Check the rear of the switch. Check the module LEDs for indications. This will only occur during an initialization self test.</p>

Proactive Networking

The ProCurve 2910al Switches have built-in management capabilities that proactively help you manage your network including:

- finding and helping you fix the most common network error conditions (for example, faulty network cabling, and non-standard network topologies)
- informing you of the problem with clear, easy-to-understand messages
- recommending network configuration changes to enhance the performance of your network

The following interfaces provide tests, indicators, and an event log that can be used to monitor the switch and its network connections and to help you take advantage of these proactive networking features:

- ProCurve Manager - an SNMP-based network management tool that is included with your switch.
- A graphical web browser interface that you can use to manage your switch from a PC running a supported web browser, for example Microsoft Internet Explorer, and Netscape Communicator.
- A full-featured easy-to-use console interface that you can access by connecting a standard terminal or PC running a terminal emulator to the switch's console port. The cable to make that connection is provided with your switch. The console interface is also accessible through a Telnet connection.

For more information on using these software tools to diagnose and manage your switch, see the “Troubleshooting” chapter in the *Management and Configuration Guide*, which is on the ProCurve Website at www.hp.com/go/procurve/manuals.

Hardware Diagnostic Tests

Testing the Switch by Resetting It

If you believe the switch is not operating correctly, you can reset the switch to test its circuitry and operating code. To reset a switch, either:

- unplug and plug in the power cord (power cycling)
- press the Reset button on the front of the switch

Power cycling the switch and pressing the Reset button both cause the switch to perform its power-on self test, which almost always will resolve any temporary operational problems. These reset processes also cause any network traffic counters to be reset to zero, and cause the System Up Time timer to reset to zero.

Checking the Switch LEDs

The self test passes if the Fault and Self Test LEDs on the front of the switch go off after approximately 50 seconds. If these LEDs stay on longer than 60 seconds or begin flashing, there may be a problem with the switch.

See “Diagnosing With the LEDs” on [page 4-4](#) for information on interpreting the LED patterns and LED behaviors in chapter one.

Checking Console Messages

Useful diagnostic messages may be displayed on the console screen when the switch is reset. As described in chapter 2 under step 7, “Connect a Console to the Switch”, connect a PC running a VT-100 terminal emulator program or a standard VT-100 terminal to the switch’s Console Port and configure it to run at 9600 baud, and with the other terminal communication settings shown on [page 2-25](#). Then, when you reset the switch, note the messages that are displayed. Additionally, you can check the switch event log, which can be accessed from the console using the **show log** command, or from the console Main Menu.

Testing Twisted-Pair Cabling

Network cables that fail to provide a link or provide an unreliable link between the switch and the connected network device may not be compatible with the IEEE 802.3 Type 10Base-T, 100Base-TX, or 1000Base-T standards. The twisted-pair cables attached to the Switch must be compatible with the appropriate standards. To verify your cable is compatible with these standards, use a qualified cable test device.

Testing Switch-to-Device Network Communications

You can perform the following communication tests to verify the network is operating correctly between the switch and any connected device that can respond correctly to the communication test.

- Link Test -- a physical layer test that sends IEEE 802.2 test packets to any device identified by its MAC address.
- Ping Test -- a network layer test used on IP networks that sends test packets to any device identified by its IP address.

These tests can be performed through the switch console interface from a terminal connected to the switch or through a Telnet connection, or from the switch's web browser interface. For more information, see the *Management and Configuration Guide*, which is on the ProCurve Website at www.hp.com/go/procurve/manuals.

These tests can also be performed from an SNMP network management station running a program that can manage the switch, for example, ProCurve Manager.

Testing End-to-End Network Communications

Both the switch and the cabling can be tested by running an end-to-end communications test -- a test that sends known data from one network device to another through the switch. For example, if you have two PCs on the network that have LAN adapters between which you can run a link-level test or Ping test through the switch, you can use this test to verify that the entire communication path between the two PCs is functioning correctly. See your LAN adapter documentation for more information on running a link test or Ping test.

Restoring the Factory Default Configuration

As part of your troubleshooting process on the switch, it may become necessary to return the switch configuration to the factory default settings. This process momentarily interrupts the switch operation, clears any passwords, clears the console event log, resets the network counters to zero, performs a complete self test, and reboots the switch into its factory default configuration including deleting the IP address, if one is configured.

Note

This process removes all switch configuration changes you have made from the factory default settings. This includes, for example, configuration of VLANs, Spanning Tree, trunks, and stacking. Returning the configuration of these features to their factory default settings (usually disabling them) may result in network connectivity issues.

If the switch has a valid configuration, and you are restoring the factory default settings for a reason other than configuration problems, you should save the switch configuration prior to performing the factory default reset. Then, after the reset and resolution of the original problem, you can restore the saved configuration to the switch. For both the save and restore processes, you can use the console **copy** command. For more information on this command, see the *Management and Configuration Guide*, which is on the ProCurve Website at www.hp.com/go/procurve/manuals.

You can restore the factory default configuration either on the switch itself, or through the switch console.

To execute the factory default reset on the switch, perform these steps:

1. Using pointed objects, simultaneously press both the Reset and Clear buttons on the front of the switch.
2. Continue to press the Clear button while releasing the Reset button.
3. When the Self Test LED begins to flash, release the Clear button.

The switch will then complete its self test and begin operating with its configuration restored to the factory default settings.

To restore the factory default configuration using the console, execute the **erase startup-config** command from the console command prompt.

Downloading New Switch Software

When product enhancements occur for the switch, new software can be downloaded to the switch through several methods, for product enhancements and new features. For more information, see the *Management and Configuration Guide*, which is on the ProCurve Website at www.hp.com/go/procurve/manuals.

The new switch software would be available on the ProCurve Website at www.hp.com/go/procurve/software.

HP Customer Support Services

If you are still having trouble with your switch, Hewlett-Packard offers support 24 hours a day, seven days a week through the use of a number of automated electronic services. See the Customer Support/Warranty booklet that came with your switch for information on how to use these services to get technical support. The ProCurve Website at www.hp.com/go/procurve/support also provides up-to-date support information.

Additionally, your ProCurve authorized network reseller can provide you with assistance, both with services that they offer and with services offered by ProCurve.

Before Calling Support

Before calling your networking dealer or ProCurve Support, to make the support process most efficient, you first should have retrieved the following information:

Information Item	Information Location
<ul style="list-style-type: none">product identification, including mini-GBICs	the front of the switch and on labels on the mini-GBICs
<ul style="list-style-type: none">details about the switch's status including the software (OS) version, a copy of the switch configuration, a copy of the switch Event Log, and a copy of the switch status and counters information	switch console: show tech command
<ul style="list-style-type: none">copy of your network topology map, including network addresses assigned to the relevant devices	your network records

Switch Specifications

Physical

	2910al-24G (J9145A)	2910al-48G (J9147A)	2910al-24G-PoE+ (J9146A)	2910al-48G-PoE+ (J9148A)
Width:	44.19 cm (17.4 in)	44.19 cm (17.4 in)	44.19 cm (17.4 in)	44.19 cm (17.4 in)
Depth:	36.57 cm (14.4 in)	36.57 cm (14.4 in)	36.57 cm (14.4 in)	36.57 cm (14.4 in)
Height:	4.4 cm (1.7 in)	4.4 cm (1.7 in)	4.4 cm (1.7 in)	4.4 cm (1.7 in)
Weight:	4.95 kg (10.92 lbs)	5.08 kg (11.2 lbs)	5.59 kg (12.34 lbs)	5.88 kg (12.96 lbs)

Electrical

The switch automatically adjusts to any voltage between 100-127 and 200-240 volts and either 50 or 60 Hz.

	2910al-24G (J9145A)	2910al-48G (J9147A)	2910al-24G-PoE+ (J9146A)	2910al-48G-PoE+ (J9148A)
AC voltage:	100-127/200-240 volts	100-127/200-240 volts	100-127/200-240 volts	100-127/200-240 volts
Maximum current:	1.7A/0.9A	2.10A/1.1A	6.1A/3.1A	6.4A/3.2A
Frequency range:	50/60 Hz	50/60 Hz	50/60 Hz	50/60 Hz

Environmental

	All four models	Operating	Non-Operating
Temperature:		0°C to 55°C (32°F to 131°F)	-40°C to 70°C (-40°F to 158°F)
Relative humidity: (non-condensing)		15% to 95% at 40°C (104°F)	15% to 90% at 65°C (149°F)
Maximum altitude:		3.0 km (10,000 ft)	3.0 km (10,000 ft)

Acoustic

ProCurve Switch 2910al-24G (J9145A)

Geraeuschemission LpA=41.1 dB am fiktiven Arbeitsplatz nach DIN 45635 T.19

Noise Emission LpA=41.1 dB at virtual workspace according to DIN 45635 T.19

ProCurve Switch 2910al-48G (J9147A)

Geraeuschemission LpA=41.1 dB am fiktiven Arbeitsplatz nach DIN 45635 T.19

Noise Emission LpA=41.1 dB at virtual workspace according to DIN 45635 T.19

ProCurve Switch 2910al-24G-PoE+ (J9146A)

Geraeuschemission LpA=39.5 dB am fiktiven Arbeitsplatz nach DIN 45635 T.19

Noise Emission LpA=39.5 dB at virtual workspace according to DIN 45635 T.19

ProCurve Switch 2910al-48G-PoE+ (J9148A)

Geraeuschemission LpA=41.1 dB am fiktiven Arbeitsplatz nach DIN 45635 T.19

Noise Emission LpA=41.1 dB at virtual workspace according to DIN 45635 T.19

Safety

Complies with:

- EN60950
- CSA 22.2 No. 60950
- UL 60950
- IEC 60950

Table A-1. Technology standards and safety compliance

Technology	Compatible with these IEEE standards	Laser safety information			Media Converter Lasers
		EN/IEC standard compliance	SFP ("mini-GBIC") Lasers	SFP+ Lasers	
10/100/1000-T	IEEE 802.3 10BASE-T, IEEE 802.3u 100BASE-TX, IEEE 802.3ab 1000BASE-T				
100-FX	IEEE 802.3u 100BASE-FX	EN/IEC 60825	Class 1 Laser Product Laser Klasse 1		
100-BX	IEEE 802.3ah 100BASE-BX10	EN/IEC 60825	Class 1 Laser Product Laser Klasse 1		
1000-SX	IEEE 802.3z 1000BASE-SX	EN/IEC 60825	Class 1 Laser Product Laser Klasse 1		
1000-LX	IEEE 802.3z 1000BASE-LX	EN/IEC 60825	Class 1 Laser Product Laser Klasse 1		
1000-LH	(not an IEEE standard)	EN/IEC 60825	Class 1 Laser Product Laser Klasse 1		
1000-BX	IEEE 802.3ah 1000BASE-BX10	EN/IEC 60825	Class 1 Laser Product Laser Klasse 1		
10-Gig CX4	IEEE 802.3ak 10GBASE-CX4				
10-Gig Direct Attach	(not an IEEE standard)				
10-Gig SR	IEEE 802.3ae 10GBASE-SR	EN/IEC 60825		Class 1 Laser Product Laser Klasse 1	
10-Gig LRM	IEEE 802.3aq 10GBASE-LRM	EN/IEC 60825		Class 1 Laser Product Laser Klasse 1	
10-Gig LR	IEEE 802.3ae 10GBASE-LR	EN/IEC 60825		Class 1 Laser Product Laser Klasse 1	
CX4 Media Converter	(not an IEEE standard)	EN/IEC 60825			Class 1m Laser Product Laser Klasse 1m

B

Module Specifications

Physical

Modules

Width:	106.17 mm (4.18 in)
Depth:	104.39 mm (4.11 in)
Height:	35.56 mm (1.40 in)
Weight:	0.159 kg (.35 lbs)

Environmental

MODULE

	Operating	Non-Operating
Temperature:	0°C to 55°C (32°F to 131°F)	-40°C to 70°C (-40°F to 158°F)
Relative humidity: (non-condensing)	15% to 95% at 40°C (104°F)	15% to 90% at 65°C (149°F)
Maximum altitude:	3.0 Km (10,000 ft)	4.6 Km (15,000 ft)

Optical Power Specifications

See the transceiver specifications which is on the ProCurve Website at www.hp.com/go/procurve/faqs, go to "ProCurve Mini-GBICs and Transceivers" and click on "ProCurve 10-GbE transceivers" and go to Specifications.

Cabling and Technology Information

This appendix includes network cable information for cables that should be used with the Switch 2910a1, including minimum pin-out information and specifications for twisted-pair cables.

Note

Incorrectly wired cabling is the most common cause of problems for LAN communications. ProCurve recommends that you work with a qualified LAN cable installer for assistance with your cabling requirements.

Cabling specifications

Table C-1.

Twisted-pair copper	10 Mbps Operation	Category 3, 4, or 5 100-ohm unshielded twisted-pair (UTP) or shielded twisted-pair (STP) cable, complying with IEEE 802.3 10Base-T specifications.
	100 Mbps Operation	Category 5 100-ohm UTP or STP cable, complying with IEEE 802.3u 100Base-TX specifications.
	1000 Mbps Operation	Category 5 100-ohm 4-pair UTP or STP cable, complying with IEEE 802.3ab 1000Base-T specifications—Category 5e or better is recommended. See note on 1000Base-T Cable Requirements on page C-2 .
Twinaxial copper	CX4 cables	Twinaxial cables complying with IEEE 802.3ak 10GBASE-CX4 specifications.
	Direct attach cables	One-piece devices consisting of a cable with SFP+ connectors permanently attached to each end, complying with SFF-8431 SFP+ specifications.
Multimode fiber		62.5/125 μm or 50/125 μm (core/cladding) diameter, low metal content, graded index fiber-optic cables, complying with the ITU-T G.651 and ISO/IEC 793-2 Type A1b or A1a standards respectively. ¹
Single mode fiber		9/125 μm (core/cladding) diameter, low metal content fiber-optic cables, complying with the ITU-T G.652 and ISO/IEC 793-2 Type B1 standards.

¹ A mode conditioning patch cord may be needed for some Gigabit-LX and 10-Gigabit LRM installations. See “[Mode Conditioning Patch Cord](#)” on [page C-4](#) for more information.

Note on 1000Base-T Cable Requirements. The Category 5 networking cables that work for 100Base-TX connections should also work for 1000Base-T, as long as all four-pairs are connected. But, for the most robust connections you should use cabling that complies with the Category 5e specifications, as described in Addendum 5 to the TIA-568-A standard (ANSI/TIA/EIA-568-A-5).

Because of the increased speed provided by 1000Base-T (Gigabit-T), network cable quality is more important than for either 10Base-T or 100Base-TX. Cabling plants being used to carry 1000Base-T networking must comply with the IEEE 802.3ab standards. In particular, the cabling must pass tests for Attenuation, Near-End Crosstalk (NEXT), and Far-End Crosstalk (FEXT). Additionally, unlike the cables for 100Base-TX, the 1000Base-T cables must pass tests for Equal-Level Far-End Crosstalk (ELFEXT) and Return Loss.

When testing your cabling, be sure to include the patch cables that connect the switch and other end devices to the patch panels on your site. The patch cables are frequently overlooked when testing cable and they must also comply with the cabling standards.

Technology distance specifications

Table C-2.

Technology	Supported cable type	Multimode fiber modal bandwidth	Supported distances
100-FX	multimode fiber	any	up to 2,000 meters
100-BX	single mode fiber	N/A	0.5 - 10,000 meters
1000-T	twisted-pair copper	N/A	up to 100 meters
1000-SX	multimode fiber	160 MHz*km	2 - 220 meters
		200 MHz*km	2 - 275 meters
		400 MHz*km	2 - 500 meters
		500 MHz*km	2 - 550 meters
1000-LX	multimode fiber	400 MHz*km	2 - 550 meters
	single mode fiber	500 MHz*km	2 - 550 meters
	single mode fiber	N/A	2 - 10,000 meters
1000-LH	single mode fiber	N/A	10 - 70,000 meters ¹
1000-BX	single mode fiber	N/A	0.5 - 10,000 meters
10-Gig CX4	twinaxial copper	N/A	up to 15 meters
10-Gig Direct Attach	twinaxial copper	N/A	(various lengths offered)
10-Gig SR	multimode fiber	160 MHz*km	2 - 26 meters
		200 MHz*km	2 - 33 meters
		400 MHz*km	2 - 66 meters
		500 MHz*km	2 - 82 meters
		2000 MHz*km	2 - 300 meters
10-Gig LRM	multimode fiber	400 MHz*km	0.5 - 100 meters
		500 MHz*km	0.5 - 220 meters
10-Gig LR	single mode fiber	N/A	2 - 10,000 meters
CX4 Media Converter	12-strand female-female multimode fiber MPO ribbon cable with MTP connectors, in a crossover (key up/key up) configuration	150 MHz*km	1 - 50 meters
		500 MHz*km	1 - 100 meters
		2000 MHz*km	1 - 300 meters

¹ For distances less than 20km, a 10dB attenuator must be used. For distances between 20km and 40km, a 5dB attenuator must be used. Attenuators can be purchased from most cable vendors.

Mode Conditioning Patch Cord

The following information applies to installations in which multimode fiber-optic cables are connected to a Gigabit-LX port or a 10-Gigabit LRM port. Multimode cable has a design characteristic called “Differential Mode Delay”, which requires the transmission signals be “conditioned” to compensate for the cable design and thus prevent resulting transmission errors.

Under certain circumstances, depending on the cable used and the lengths of the cable runs, an external Mode Conditioning Patch Cord may need to be installed between the Gigabit-LX or 10-Gigabit LRM transmitting device and the multimode network cable to provide the transmission conditioning. If you experience a high number of transmission errors on those ports, usually CRC or FCS errors, you may need to install one of these patch cords between the fiber-optic port in your switch and your multimode fiber-optic network cabling, at both ends of the network link.

The patch cord consists of a short length of single mode fiber cable coupled to graded-index multimode fiber cable on the transmit side, and only multimode cable on the receive side. The section of single mode fiber is connected in such a way that it minimizes the effects of the differential mode delay in the multimode cable.

Note

Most of the time, if you are using good quality graded-index multimode fiber cable that adheres to the standards listed in Appendix B, there should not be a need to use mode conditioning patch cords in your network. This is especially true if the fiber runs in your network are relatively short.

For 10-Gigabit LRM using OM3 cable (50 μm multimode @ 1500/500 MHz*km), a mode conditioning patch cord is not required. Other multimode cables may require mode conditioning patch cords to achieve the LRM maximum distances.

Installing the Patch Cord

As shown in the illustration below, connect the patch cord to the ProCurve transceiver with the section of single mode fiber plugged in to the Tx (transmit) port. Then, connect the other end of the patch cord to your network cabling patch panel, or directly to the network multimode fiber.

If you connect the patch cord directly to the network cabling, you may need to install a female-to-female adapter to allow the cables to be connected together.

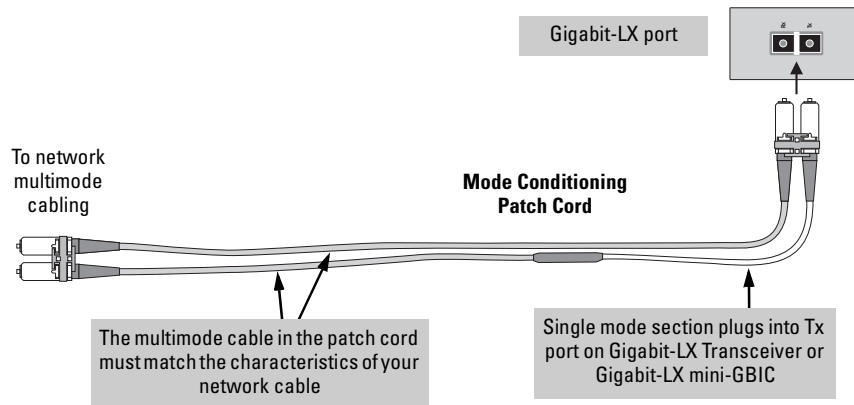

Figure C-1. Example: Connecting a Mode Conditioning Patch Cord for Gigabit-LX

Make sure you purchase a patch cord that has appropriate connectors on each end, and has multimode fibers that match the characteristics of the multimode fiber in your network. Most important, the core diameter of the multimode patch cord must match the core diameter of the multimode cable infrastructure (either 50 or 62.5 microns).

Twisted-Pair Cable/Connector Pin-Outs

Auto-MDIX Feature: The 10/100/1000-T ports support the IEEE 802.3ab standard, which includes the “Auto MDI/MDI-X” feature. In the default configuration, “Auto”, the ports on the Switch 2910al all automatically detect the type of port on the connected device and operate as either an MDI or MDI-X port, whichever is appropriate. So for any connection, a straight-through twisted-pair cable can be used – *you no longer have to use crossover cables*, although crossover cables can also be used for any of the connections.

If you connect a Switch 2910al twisted-pair port to another switch or hub, which typically have MDI-X ports, the Switch 2910al port automatically operates as an MDI port. If you connect it to an end node, such as a server or PC, which typically have MDI ports, the Switch 2910al port operates as an MDI-X port. In all cases, you can use standard straight-through cables or crossover cables.

If you happen to use a correctly wired crossover cable, though, the switch will still be able to automatically detect the MDI/MDI-X operation and link correctly to the connected device.

Other Wiring Rules:

- All twisted-pair wires used for 10 Mbps, and 100 Mbps operation must be twisted through the entire length of the cable. The wiring sequence must conform to EIA/TIA 568-B (not USOC). See “Twisted-Pair Cable Pin Assignments” later in this appendix for a listing of the signals used on each pin.
- For 1000Base-T connections, all four pairs of wires in the cable must be available for data transmission. See [“Note on 1000Base-T Cable Requirements” on page C-2](#) for more information on 1000Base-T cabling.
- For 10 Mbps connections to the ports, you can use Category 3, 4, or 5 unshielded twisted-pair cable, as supported by the IEEE 802.3 Type 10Base-T standard.
- For 100 Mbps connections to the ports, use 100-ohm Category 5 UTP or STP cable only, as supported by the IEEE 802.3u Type 100Base-TX standard.
- For 1000 Mbps connections, 100-ohm Category 5e or better cabling is recommended.

Straight-Through Twisted-Pair Cable for 10 Mbps or 100 Mbps Network Connections

Because of the HP Auto-MDIX operation of the 10/100 ports on the switch, for all network connections, to PCs, servers or other end nodes, or to hubs or other switches, you can use straight-through cables.

If any of these ports are given a fixed configuration, for example 100 Mbps/ Full Duplex, the ports operate as MDI-X ports, and straight-through cables must be then used for connections to PC NICs and other MDI ports.

Cable Diagram

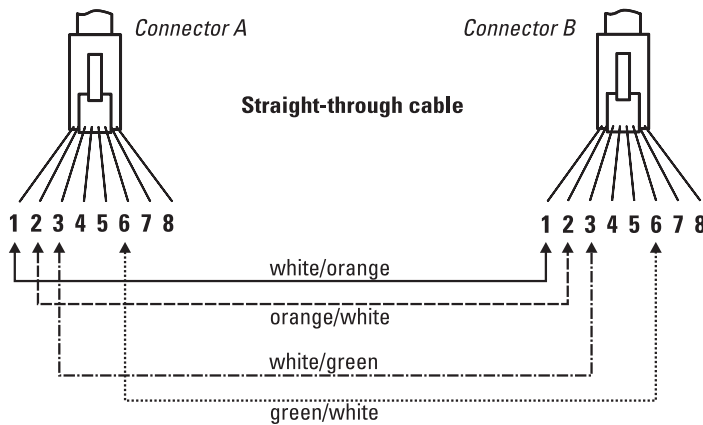

Note

Pins 1 and 2 on connector “A” *must* be wired as a twisted pair to pins 1 and 2 on connector “B”.

Pins 3 and 6 on connector “A” *must* be wired as a twisted pair to pins 3 and 6 on connector “B”.

Pins 4, 5, 7, and 8 are not used in this application, although they may be wired in the cable.

Pin Assignments

Switch End (MDI-X)		Computer, Transceiver, or Other End		
Signal	Pins	Pins	Signal	
receive +	1	←————→	1	transmit +
receive -	2	←————→	2	transmit -
transmit +	3	————→	3	receive +
transmit -	6	————→	6	receive -

Crossover Twisted-Pair Cable for 10 Mbps or 100 Mbps Network Connection

The HP Auto-MDIX operation of the 10/100 ports on the switch also allows you to use crossover cables for all network connections, to PCs, servers or other end nodes, or to hubs or other switches.

If any of these ports are given a fixed configuration, for example 100 Mbps/ Full Duplex, the ports operate as MDI-X ports, and crossover cables *must* be then used for connections to hubs or switches or other MDI-X network devices.

Cable Diagram

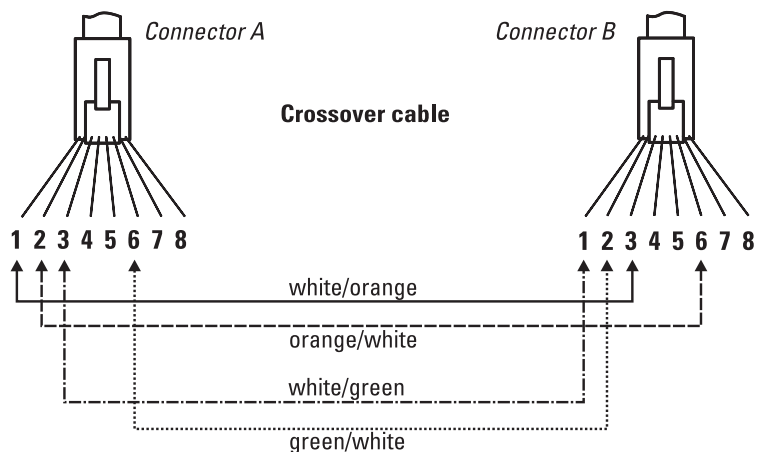

Note

Pins 1 and 2 on connector “A” *must* be wired as a twisted pair to pins 3 and 6 on connector “B”.

Pins 3 and 6 on connector “A” *must* be wired as a twisted pair to pins 1 and 2 on connector “B”.

Pins 4, 5, 7, and 8 are not used in this application, although they may be wired in the cable.

Pin Assignments

Switch End (MDI-X)		Hub or Switch Port, or Other MDI-X Port End	
Signal	Pins	Pins	Signal
receive +	1	6	transmit -
receive -	2	3	transmit +
transmit +	3	2	receive -
transmit -	6	1	receive +

Straight-Through Twisted-Pair Cable for 1000 Mbps Network Connections

1000Base-T connections require that all four pairs or wires be connected.

Cable Diagram

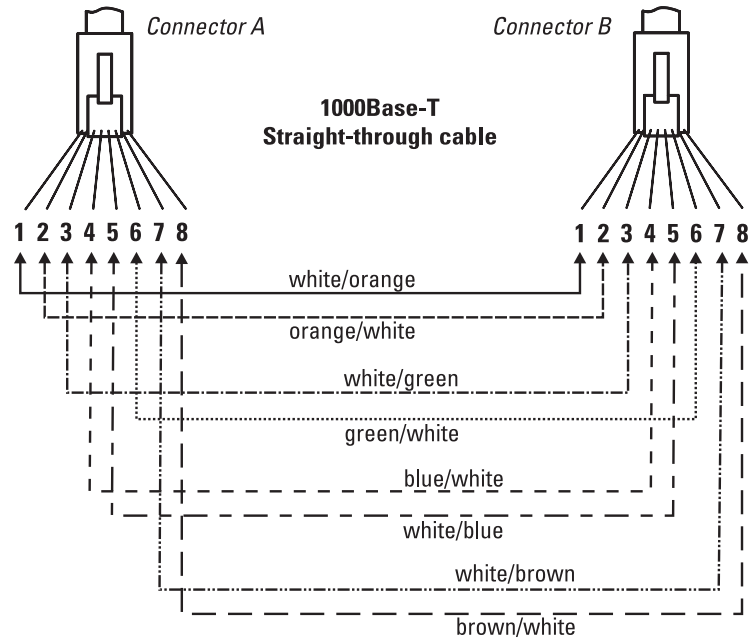

Note

Pins 1 and 2 on connector "A" *must* be wired as a twisted pair to pins 1 and 2 on connector "B".

Pins 3 and 6 on connector "A" *must* be wired as a twisted pair to pins 3 and 6 on connector "B".

Pins 4 and 5 on connector "A" *must* be wired as a twisted pair to pins 4 and 5 on connector "B".

Pins 7 and 8 on connector "A" *must* be wired as a twisted pair to pins 7 and 8 on connector "B".

Pin Assignments

For 1000Base-T operation, all four pairs of wires are used for both transmit and receive.

Safety and EMC Regulatory Statements

Safety Information



Documentation reference symbol. If the product is marked with this symbol, refer to the product documentation to get more information about the product.

WARNING

A **WARNING** in the manual denotes a hazard that can cause injury or death.

Caution

A Caution in the manual denotes a hazard that can damage equipment.

Do not proceed beyond a **WARNING** or Caution notice until you have understood the hazardous conditions and have taken appropriate steps.

Grounding

These are safety class I products and have protective earthing terminals. There must be an uninterruptible safety earth ground from the main power source to the product's input wiring terminals, power cord, or supplied power cord set. Whenever it is likely that the protection has been impaired, disconnect the power cord until the ground has been restored.

For LAN cable grounding:

- If your LAN covers an area served by more than one power distribution system, be sure their safety grounds are securely interconnected.
- LAN cables may occasionally be subject to hazardous transient voltages (such as lightning or disturbances in the electrical utilities power grid). Handle exposed metal components of the network with caution.

Servicing

There are no user-serviceable parts inside these products. Any servicing, adjustment, maintenance, or repair must be performed only by service-trained personnel.

These products do not have a power switch; they are powered on when the power cord is plugged in.

Informations concernant la sécurité



Symbole de référence à la documentation. Si le produit est marqué de ce symbole, reportez-vous à la documentation du produit afin d'obtenir des informations plus détaillées.

WARNING

Dans la documentation, un **WARNING** indique un danger susceptible d'entraîner des dommages corporels ou la mort.

Caution

Un texte de mise en garde intitulé Caution indique un danger susceptible de causer des dommages à l'équipement.

Ne continuez pas au-delà d'une rubrique **WARNING** ou Caution avant d'avoir bien compris les conditions présentant un danger et pris les mesures appropriées.

Cet appareil est un produit de classe I et possède une borne de mise à la terre. La source d'alimentation principale doit être munie d'une prise de terre de sécurité installée aux bornes du câblage d'entrée, sur le cordon d'alimentation ou le cordon de raccordement fourni avec le produit. Lorsque cette protection semble avoir été endommagée, débrancher le cordon d'alimentation jusqu'à ce que la mise à la terre ait été réparée.

Mise à la terre du câble de réseau local:

- si votre réseau local s'étend sur une zone desservie par plus d'un système de distribution de puissance, assurez-vous que les prises de terre de sécurité soient convenablement interconnectées.
- Les câbles de réseaux locaux peuvent occasionnellement être soumis à des surtensions transitoires dangereuses (telles que la foudre ou des perturbations dans le réseau d'alimentation public). Manipulez les composants métalliques du réseau avec précautions.

Aucune pièce contenue à l'intérieur de ce produit ne peut être réparée par l'utilisateur. Tout dépannage, réglage, entretien ou réparation devra être confié exclusivement à un personnel qualifié.

Cet appareil ne comporte pas de commutateur principal; la mise sous tension est effectuée par branchement du cordon d'alimentation.

Hinweise zur Sicherheit



Symbol für Dokumentationsverweis. Wenn das Produkt mit diesem Symbol markiert ist, schlagen Sie bitte in der Produktdokumentation nach, um mehr Informationen über das Produkt zu erhalten.

WARNING

Eine **WARNING** in der Dokumentation symbolisiert eine Gefahr, die Verletzungen oder sogar Todesfälle verursachen kann.

Caution

Caution in der Dokumentation symbolisiert eine Gefahr, die das Gerät beschädigen kann.

Fahren Sie nach dem Hinweis **WARNING** oder Caution erst fort, nachdem Sie den Gefahrezustand verstanden und die entsprechenden Maßnahmen ergriffen haben.

Dies ist ein Gerät der Sicherheitsklasse I und verfügt über einen schützenden Erdungsterminal. Der Betrieb des Geräts erfordert eine ununterbrochene Sicherheitserdung von der Hauptstromquelle zu den Geräteingabeterminals, den Netzkabeln oder dem mit Strom belieferten Netzkabelsatz voraus. Sobald Grund zur Annahme besteht, daß der Schutz beeinträchtigt worden ist, das Netzkabel aus der Wandsteckdose herausziehen, bis die Erdung wiederhergestellt ist.

Für LAN-Kabelerdung:

- Wenn Ihr LAN ein Gebiet umfaßt, das von mehr als einem Stromverteilungssystem beliefert wird, müssen Sie sich vergewissern, daß die Sicherheitserdungen fest untereinander verbunden sind.
- LAN-Kabel können gelegentlich gefährlichen Übergangsspannungen ausgesetzt werden (beispielsweise durch Blitz oder Störungen in dem Starkstromnetz des Elektrizitätswerks). Bei der Handhabung exponierter Metallbestandteile des Netzwerkes Vorsicht walten lassen.

Dieses Gerät enthält innen keine durch den Benutzer zu wartenden Teile. Wartungs-, Anpassungs-, Instandhaltungs- oder Reparaturarbeiten dürfen nur von geschultem Bedienungspersonal durchgeführt werden.

Dieses Gerät hat keinen Netzschalter; es wird beim Anschließen des Netzkabels eingeschaltet.

Considerazioni sulla sicurezza



WARNING

Simbolo di riferimento alla documentazione. Se il prodotto è contrassegnato da questo simbolo, fare riferimento alla documentazione sul prodotto per ulteriori informazioni su di esso.

La dicitura **WARNING** denota un pericolo che può causare lesioni o morte.

Caution

La dicitura **Caution** denota un pericolo che può danneggiare le attrezzature.

Non procedere oltre un avviso di **WARNING** o di **Caution** prima di aver compreso le condizioni di rischio e aver provveduto alle misure del caso.

Questo prodotto è omologato nella classe di sicurezza I ed ha un terminale protettivo di collegamento a terra. Dev'essere installato un collegamento a terra di sicurezza, non interrompibile che vada dalla fonte d'alimentazione principale ai terminali d'entrata, al cavo d'alimentazione oppure al set cavo d'alimentazione fornito con il prodotto. Ogniqualvolta vi sia probabilità di danneggiamento della protezione, disinserite il cavo d'alimentazione fino a quando il collegamento a terra non sia stato ripristinato.

Per la messa a terra dei cavi LAN:

- se la vostra LAN copre un'area servita da più di un sistema di distribuzione elettrica, accertatevi che i collegamenti a terra di sicurezza siano ben collegati fra loro;
- i cavi LAN possono occasionalmente andare soggetti a pericolose tensioni transitorie (ad esempio, provocate da lampi o disturbi nella griglia d'alimentazione della società elettrica); siate cauti nel toccare parti esposte in metallo della rete.

Nessun componente di questo prodotto può essere riparato dall'utente. Qualsiasi lavoro di riparazione, messa a punto, manutenzione o assistenza va effettuato esclusivamente da personale specializzato.

Questo apparato non possiede un commutatore principale; si mette scotto tensione all'inserirsi il cavo d'alimentazione.

Consideraciones sobre seguridad



WARNING

Símbolo de referencia a la documentación. Si el producto va marcado con este símbolo, consultar la documentación del producto a fin de obtener mayor información sobre el producto.

Una **WARNING** en la documentación señala un riesgo que podría resultar en lesiones o la muerte.

Caution

Una Caution en la documentación señala un riesgo que podría resultar en averías al equipo.

No proseguir después de un símbolo de **WARNING** o Caution hasta no haber entendido las condiciones peligrosas y haber tomado las medidas apropiadas.

Este aparato se enmarca dentro de la clase I de seguridad y se encuentra protegido por una borna de puesta a tierra. Es preciso que exista una puesta a tierra continua desde la toma de alimentación eléctrica hasta las bornas de los cables de entrada del aparato, el cable de alimentación o el juego de cable de alimentación suministrado. Si existe la probabilidad de que la protección a tierra haya sufrido desperfectos, desenchufar el cable de alimentación hasta haberse subsanado el problema.

Puesta a tierra del cable de la red local (LAN):

- Si la LAN abarca un área cuyo suministro eléctrico proviene de más de una red de distribución de electricidad, cerciorarse de que las puestas a tierra estén conectadas entre sí de modo seguro.
- Es posible que los cables de la LAN se vean sometidos de vez en cuando a voltajes momentáneos que entrañen peligro (rayos o alteraciones en la red de energía eléctrica). Manejar con precaución los componentes de metal de la LAN que estén al descubierto.

Este aparato no contiene pieza alguna susceptible de reparación por parte del usuario. Todas las reparaciones, ajustes o servicio de mantenimiento debe realizarlos solamente el técnico.

Este producto no tiene interruptor de potencia; se activa cuando se enchufa el cable de alimentación.

Safety Information (Japan)

安全性の考慮

安全記号



マニュアル参照記号。製品にこの記号がついている場合はマニュアルを参照し、注意事項等をご確認ください。

WARNING マニュアル中の「WARNING」は人身事故の原因となる危険を示します。

CAUTION マニュアル中の「CAUTION」は装置破損の原因となる危険を示します。

「WARNING」や「CAUTION」の項は飛ばさないで必ずお読みください。危険性に関する記載事項をよく読み、正しい手順に従った上で次の事項に進んでください。

これは安全性クラス I の製品で保護用接地端子を備えています。主電源から製品の入力配線端子、電源コード、または添付の電源コード・セットまでの間、切れ目のない安全接地が存在することが必要です。もしこの保護回路が損なわれたことが推測されるときは、接地が修復されるまで電源コードを外しておいてください。

LAN ケーブルの接地に関して:

- もし貴社の LAN が複数の配電システムにより電力を受けている領域をカバーしている場合には、それらのシステムの安全接地が確実に相互に結合されていることを確認してください。
- LAN ケーブルは時として危険な過度電圧（例えば雷や、配電設備の電力網での障害）にさらされることがあります。露出した金属部分の取扱いには十分な注意をはらってください。

本製品の内部にはユーザーが修理できる部品はありません。サービス、調整、保守および修理はサービス訓練を受けた専門家におまかせください。

本製品には電源スイッチがありません。電源コードを接続したとき電源入となります。

Japan Power Cord Warning

製品には、同梱された電源コードをお使い下さい。
同梱された電源コードは、他の製品では使用出来ません。

Safety Information (China)

HP 网络产品使用安全手册

使用须知

欢迎使用惠普网络产品，为了您及仪器的安全，请您务必注意如下事项：

1. 仪器要和地线相接，要使用有正确接地插头的电源线，使用中国国家规定的220V电源。
2. 避免高温和尘土多的地方，否则易引起仪器内部部件的损坏。
3. 避免接近高温，避免接近直接热源，如直射太阳光、暖气等其它发热体。
4. 不要有异物或液体落入机内，以免部件短路。
5. 不要将磁体放置于仪器附近。

警告

为防止火灾或触电事故，请不要将该机放置于淋雨或潮湿处。

安装

安装辅助管理模块，请参看安装指南。

保修及技术支持

如果您按照以上步骤操作时遇到了困难，或想了解其它产品性能，请按以下方式与我们联系。

如是硬件故障：

1. 与售出单位或当地维修机构联系。
2. 中国惠普有限公司维修中心地址：
北京市海淀区知春路49号希格玛大厦
联系电话：010-62623888 转 6101
邮政编码：100080

如是软件问题：

1. 惠普用户响应中心热线电话：010-65645959
2. 传真自动回复系统：010-65645735

EMC Regulatory Statements

U.S.A.

FCC Class A

This equipment has been tested and found to comply with the limits for a Class A digital device, pursuant to Part 15 of the FCC Rules. These limits are designed to provide reasonable protection against interference when the equipment is operated in a commercial environment. This equipment generates, uses, and can radiate radio frequency energy and, if not installed and used in accordance with the instruction manual, may cause interference to radio communications. Operation of this equipment in a residential area may cause interference in which case the user will be required to correct the interference at his own expense.

Canada

This product complies with Class A Canadian EMC requirements.

Australia/New Zealand



This product complies with Australia/New Zealand EMC Class A requirements.

Japan

VCCI Class A

この装置は、情報処理装置等電波障害自主規制協議会（VCCI）の基準に基づくクラスA情報技術装置です。この装置を家庭環境で使用すると電波妨害を引き起こすことがあります。この場合には使用者が適切な対策を講ずるよう要求されることがあります。

Korea

사용자 안내문 : A 급기기

이기는 업무용으로 전자파 적합등록을 받은 기기 이오니, 판매자 또는 사용자는 이점을 주의하시기 바라며, 만약 잘못 구입하셨을 때에는 구입한 곳에서 비업무용으로 교환하시기 바랍니다.

Taiwan

警告使用者：這是甲類的資訊產品，在居住的環境中使用時，可能會造成射頻干擾，在這種情況下，使用者會被要求採取某些適當的對策。

European Community



DECLARATION OF CONFORMITY
according to ISO/IEC 17050-1 and EN 17050-1

DoC #: RSVLC-0703-11-26-08

Supplier's Name: Hewlett-Packard Company
Manufacturer's Address: 8000 Foothills Blvd., Roseville, CA 95747 U.S.A.

declares, that the product

Product Name²: HP ProCurve 2910al Switch Series
Product Number(s): J9145A, J9147A
Regulatory Model No¹: RSVLC-0703
Product Options: All

conforms to the following Product Specifications and Regulations:

EMC: Class A
EN 55022:2006/CISPR 22:2005
EN 55024:1998 + A1:2001 + A2:2003
EN 61000-3-2:2006
EN 61000-3-3:1995 + A1:2001 + A2:2005
FCC CFR47 Part 15

Safety:
EN 60950-1:2001
IEC 60950-1: 2001
EN 60825-1:1994 +A1+A2 / IEC 60825-1:1993 +A2 Class 1

Supplementary Information:

The device complies with part 15 of the FCC Rules. Operation is subject to the following two conditions: (1) this device may not cause harmful interference, and (2) this device must accept any interference received, including interference that may cause undesired operation.

The product herewith complies with the requirements of the Low Voltage Directive 2006/95/EC, the EMC Directive 2004/108/EC and carries the CE marking accordingly.

Additional Information:

1) This product is assigned a Regulatory Model Number which stays with the regulatory aspects of the design. The Regulatory Model Number is the main product identifier in the regulatory documentation and test reports, this number should not be confused with the marketing name or the product numbers.

2) This product was tested with HP branded products only.

Roseville, 26-November-2008

Michael E. Avery, Regulatory Eng. Manager

Local contact for regulatory information:

EMEA: Hewlett-Packard GmbH, HQ-TRE, Herrenberger Straße 140, D-71034 Böblingen, Germany
U.S.: Hewlett-Packard, 3000 Hanover St., Palo Alto, CA 94304, U.S.A. 650-857-1501



DECLARATION OF CONFORMITY
according to ISO/IEC 17050-1 and EN 17050-1

DoC #: RSVLC-0703-12-01-08

Supplier's Name: Hewlett-Packard Company
Manufacturer's Address: 8000 Foothills Blvd., Roseville, CA 95747 U.S.A.

declares, that the product

Product Name²: HP ProCurve 2910al Switch Series
Product Number(s): J9146A, J9148A
Regulatory Model No¹: RSVLC-0705
Product Options: All

conforms to the following Product Specifications and Regulations:

EMC: Class A
EN 55022:2006/CISPR 22:2005
EN 55024:1998 + A1:2001 + A2:2003
EN 61000-3-2:2006
EN 61000-3-3:1995 + A1:2001 + A2:2005
FCC CFR47 Part 15

Safety:
EN 60950-1:2001
IEC 60950-1: 2001
EN 60825-1:1994 +A1+A2 / IEC 60825-1:1993 +A2 Class 1

Supplementary Information:

The device complies with part 15 of the FCC Rules. Operation is subject to the following two conditions: (1) this device may not cause harmful interference, and (2) this device must accept any interference received, including interference that may cause undesired operation.

The product herewith complies with the requirements of the Low Voltage Directive 2006/95/EC, the EMC Directive 2004/108/EC and carries the CE marking accordingly.

Additional Information:

1) This product is assigned a Regulatory Model Number which stays with the regulatory aspects of the design. The Regulatory Model Number is the main product identifier in the regulatory documentation and test reports, this number should not be confused with the marketing name or the product numbers.

2) This product was tested with HP branded products only.

Roseville, 01-December-2008

Michael E. Avery, Regulatory Eng. Manager

Local contact for regulatory information:

EMEA: Hewlett-Packard GmbH, HQ-TRE, Herrenberger Straße 140, D-71034 Böblingen, Germany
U.S.: Hewlett-Packard, 3000 Hanover St., Palo Alto, CA 94304, U.S.A. 650-857-1501

Recycle Statements

Waste Electrical and Electronic Equipment (WEEE) Statements



Disposal of Waste Equipment by Users in Private Household in the European Union

This symbol on the product or on its packaging indicates that this product must not be disposed of with your other household waste. Instead, it is your responsibility to dispose of your waste equipment by handing it over to a designated collection point for the recycling of waste electrical and electronic equipment. The separate collection and recycling of your waste equipment at the time of disposal will help to conserve natural resources and ensure that it is recycled in a manner that protects human health and the environment. For more information about where you can drop off your waste equipment for recycling, please contact your local city office, your household waste disposal service or the shop where you purchased the product.



Likvidace zařízení soukromými domácími uživateli v Evropské unii

Tento symbol na produktu nebo balení označuje výrobek, který nesmí být vyhozen spolu s ostatním domácím odpadem. Povinností uživatele je předat takto označený odpad na předem určené sběrné místo pro recyklaci elektrických a elektronických zařízení. Okamžité třídění a recyklace odpadu pomůže uchovat přírodní prostředí a zajistí takový způsob recyklace, který ochrání zdraví a životní prostředí člověka. Další informace o možnostech odevzdání odpadu k recyklaci získáte na příslušném obecním nebo městském úřadě, od firmy zabývající se sběrem a svozem odpadu nebo v obchodě, kde jste produkt zakoupili.



Bortskaffelse af affald fra husstande i den Europæiske Union

Hvis produktet eller dets emballage er forsynet med dette symbol, angiver det, at produktet ikke må bortskaffes med andet almindeligt husholdningsaffald. I stedet er det dit ansvar at bortskaffe kasseret udstyr ved at aflevere det på den kommunale genbrugsstation, der forestår genvinding af kasseret elektrisk og elektronisk udstyr. Den centrale modtagelse og genvinding af kasseret udstyr i forbindelse med bortskaffelsen bidrager til bevarelse af naturlige ressourcer og sikrer, at udstyret genvindes på en måde, der beskytter både mennesker og miljø. Yderligere oplysninger om, hvor du kan aflevere kasseret udstyr til genvinding, kan du få hos kommunen, den lokale genbrugsstation eller i den butik, hvor du købte produktet.



Seadmete jäätmete kõrvaldamine eramajapidamistes Euroopa Liidus

See tootel või selle pakendil olev sümbol näitab, et kõnealust toodet ei tohi koos teiste majapidamisjäätmetega kõrvaldada. Teie kohus on oma seadmete jäätmed kõrvaldada, viies need elektri- ja elektroonikaseadmete jäätmete ringlussevõtmiseks selleks ettenähtud kogumispunkti. Seadmete jäätmete eraldi kogumine ja ringlussevõtmise kõrvaldamise ajal aitab kaitsta loodusvarasid ning tagada, et ringlussevõtmise toimub viisil, mis kaitseb inimeste tervist ning keskkonda. Lisateabe saamiseks selle kohta, kuhu oma seadmete jäätmed ringlussevõtmiseks viia, võtke palun ühendust oma kohaliku linnakantselei, majapidamisjäätmete kõrvaldamise teenistuse või kauplusega, kust Te toote ostsite.

Recycle Statements

Waste Electrical and Electronic Equipment (WEEE) Statements



Laitteiden hävittäminen kotitalouksissa Euroopan unionin alueella

Jos tuotteessa tai sen pakkauksessa on tämä merkki, tuotetta ei saa hävittää kotitalousjätteiden mukana. Tällöin hävitettävä laite on toimitettava sähkölaitteiden ja elektronisten laitteiden kierrätyspisteeseen. Hävitettävien laitteiden erillinen käsittely ja kierrätys auttavat säästämään luonnonvaroja ja varmistamaan, että laite kierrätetään tavalla, joka estää terveyshaitat ja suojelee luontoa. Lisätietoja paikoista, joihin hävitettävät laitteet voi toimittaa kierrätettäväksi, saa ottamalla yhteyttä jätehuoltoon tai liikkeeseen, josta tuote on ostettu.



Élimination des appareils mis au rebut par les ménages dans l'Union européenne

Le symbole apposé sur ce produit ou sur son emballage indique que ce produit ne doit pas être jeté avec les déchets ménagers ordinaires. Il est de votre responsabilité de mettre au rebut vos appareils en les déposant dans les centres de collecte publique désignés pour le recyclage des équipements électriques et électroniques. La collecte et le recyclage de vos appareils mis au rebut indépendamment du reste des déchets contribue à la préservation des ressources naturelles et garantit que ces appareils seront recyclés dans le respect de la santé humaine et de l'environnement. Pour obtenir plus d'informations sur les centres de collecte et de recyclage des appareils mis au rebut, veuillez contacter les autorités locales de votre région, les services de collecte des ordures ménagères ou le magasin dans lequel vous avez acheté ce produit.



Entsorgung von Altgeräten aus privaten Haushalten in der EU

Das Symbol auf dem Produkt oder seiner Verpackung weist darauf hin, dass das Produkt nicht über den normalen Hausmüll entsorgt werden darf. Benutzer sind verpflichtet, die Altgeräte an einer Rücknahmestelle für Elektro- und Elektronik-Altgeräte abzugeben. Die getrennte Sammlung und ordnungsgemäße Entsorgung Ihrer Altgeräte trägt zur Erhaltung der natürlichen Ressourcen bei und garantiert eine Wiederverwertung, die die Gesundheit des Menschen und die Umwelt schützt. Informationen dazu, wo Sie Rücknahmestellen für Ihre Altgeräte finden, erhalten Sie bei Ihrer Stadtverwaltung, den örtlichen Müllentsorgungsbetrieben oder im Geschäft, in dem Sie das Gerät erworben haben



Απορριψη άχρηστου εξοπλισμού από χρήστες σε ιδιωτικά νοικοκυριά στην Ευρωπαϊκή Ένωση

Το σύμβολο αυτό στο προϊόν ή τη συσκευασία του υποδεικνύει ότι το συγκεκριμένο προϊόν δεν πρέπει να διατίθεται μαζί με τα άλλα οικιακά σας απορρίμματα. Αντίθετα, είναι δική σας ευθύνη να απορρίψετε τον άχρηστο εξοπλισμό σας παραδίδοντάς τον σε καθορισμένο σημείο συλλογής για την ανακύκλωση άχρηστου ηλεκτρικού και ηλεκτρονικού εξοπλισμού. Η ξεχωριστή συλλογή και ανακύκλωση του άχρηστου εξοπλισμού σας κατά την απόρριψη θα συμβάλει στη διατήρηση των φυσικών πόρων και θα διασφαλίσει ότι η ανακύκλωση γίνεται με τρόπο που προστατεύει την ανθρώπινη υγεία και το περιβάλλον. Για περισσότερες πληροφορίες σχετικά με το πού μπορείτε να παραδώσετε τον άχρηστο εξοπλισμό σας για ανακύκλωση, επικοινωνήστε με το αρμόδιο τοπικό γραφείο, την τοπική υπηρεσία διάθεσης οικιακών απορριμμάτων ή το κατάστημα όπου αγοράσατε το προϊόν.



Készülékek magánháztartásban történő selejtezése az Európai Unió területén

A készüléken, illetve a készülék csomagolásán látható azonos szimbólum annak jelzésére szolgál, hogy a készülék a selejtezés során az egyéb háztartási hulladéktól eltérő módon kezelendő. A vásárló a hulladékká vált készüléket köteles a kijelölt gyűjtőhelyre szállítani az elektromos és elektronikai készülékek újrahasznosítása céljából. A hulladékká vált készülékek selejtezés kori begyűjtése és újrahasznosítása hozzájárul a természeti erőforrások megőrzéséhez, valamint biztosítja a selejtezett termékek környezetre és emberi egészségre nézve biztonságos feldolgozását. A begyűjtés pontos helyéről bővebb tájékoztatást a lakhelye szerint illetékes önkormányzattól, az illetékes személtakarító vállalatától, illetve a terméket elárúsító helyen kaphat.



Smaltimento delle apparecchiature da parte di privati nel territorio dell'Unione Europea

Questo simbolo presente sul prodotto o sulla confezione indica che il prodotto non può essere smaltito insieme ai rifiuti domestici. È responsabilità dell'utente smaltire le apparecchiature consegnandole presso un punto di raccolta designato al riciclo e allo smaltimento di apparecchiature elettriche ed elettroniche. La raccolta differenziata e il corretto riciclo delle apparecchiature da smaltire permette di proteggere la salute degli individui e l'ecosistema. Per ulteriori informazioni relative ai punti di raccolta delle apparecchiature, contattare l'ente locale per lo smaltimento dei rifiuti, oppure il negozio presso il quale è stato acquistato il prodotto.



Nolietotu iekārtu iznīcināšanas noteikumi lietotājiem Eiropas Savienības privātajās mājāsaimniecībās

Šāds simbols uz izstrādājuma vai uz tā iesaiņojuma norāda, ka šo izstrādājumu nedrīkst izmest kopā ar citiem sadzīves atkritumiem. Jūs atbildat par to, lai nolietotās iekārtas tiktu nodotas speciāli iekārtotos punktos, kas paredzēti izmantoto elektrisko un elektronisko iekārtu savākšanai otrreizējai pārstrādei. Atsevišķa nolietoto iekārtu savākšana un otrreizējā pārstrāde palīdzēs saglabāt dabas resursus un garantēs, ka šīs iekārtas tiks otrreizēji pārstrādātas tādā veidā, lai pasargātu vidi un cilvēku veselību. Lai uzzinātu, kur nolietotās iekārtas var izmest otrreizējai pārstrādei, jāvērsas savas dzīves vietas pašvaldībā, sadzīves atkritumu savākšanas dienestā vai veikalā, kurā izstrādājums tika nopirkts.



Vartotojū iš privačių namų ūkių įrangos atliekų šalinimas Europos Sąjungoje

Šis simbolis ant gaminio arba jo pakuotės rodo, kad šio gaminio šalinti kartu su kitomis namų ūkio atliekomis negalima. Šalintinas įrangos atliekas privalote pristatyti į specialią surinkimo vietą elektros ir elektroninės įrangos atliekoms perdirbti. Atskirai surenkamos ir perdirbamos šalintinos įrangos atliekos padės saugoti gamtinius išteklius ir užtikrinti, kad jos bus perdirbtos tokiu būdu, kuris nekenkia žmonių sveikatai ir aplinkai. Jeigu norite sužinoti daugiau apie tai, kur galima pristatyti perdirbtinas įrangos atliekas, kreipkitės į savo seniūniją, namų ūkio atliekų šalinimo tarnybą arba parduotuvę, kurioje įsigijote gaminį.



Verwijdering van afgedankte apparatuur door privé-gebruikers in de Europese Unie

Dit symbool op het product of de verpakking geeft aan dat dit product niet mag worden gedeponeerd bij het normale huishoudelijke afval. U bent zelf verantwoordelijk voor het inleveren van uw afgedankte apparatuur bij een inzamelingspunt voor het recyclen van oude elektrische en elektronische apparatuur. Door uw oude apparatuur apart aan te bieden en te recyclen, kunnen natuurlijke bronnen worden behouden en kan het materiaal worden hergebruikt op een manier waarmee de volksgezondheid en het milieu worden beschermd. Neem contact op met uw gemeente, het afvalinzamelingsbedrijf of de winkel waar u het product hebt gekocht voor meer informatie over inzamelingspunten waar u oude apparatuur kunt aanbieden voor recycling.



Pozbywanie się zużytego sprzętu przez użytkowników w prywatnych gospodarstwach domowych w Unii Europejskiej

Ten symbol na produkcie lub jego opakowaniu oznacza, że produktu nie wolno wyrzucać do zwykłych pojemników na śmieci. Obowiązkiem użytkownika jest przekazanie zużytego sprzętu do wyznaczonego punktu zbiórki w celu recyklingu odpadów powstałych ze sprzętu elektrycznego i elektronicznego. Osobna zbiórka oraz recykling zużytego sprzętu pomogą w ochronie zasobów naturalnych i zapewnią ponowne wprowadzenie go do obiegu w sposób chroniący zdrowie człowieka i środowisko. Aby uzyskać więcej informacji o tym, gdzie można przekazać zużyty sprzęt do recyklingu, należy się skontaktować z urzędem miasta, zakładem gospodarki odpadami lub sklepem, w którym zakupiono produkt.

Recycle Statements

Waste Electrical and Electronic Equipment (WEEE) Statements



Descarte de Lixo Elétrico na Comunidade Européia

Este símbolo encontrado no produto ou na embalagem indica que o produto não deve ser descartado no lixo doméstico comum. É responsabilidade do cliente descartar o material usado (lixo elétrico), encaminhando-o para um ponto de coleta para reciclagem. A coleta e a reciclagem seletivas desse tipo de lixo ajudarão a conservar as reservas naturais; sendo assim, a reciclagem será feita de uma forma segura, protegendo o ambiente e a saúde das pessoas. Para obter mais informações sobre locais que reciclam esse tipo de material, entre em contato com o escritório da HP em sua cidade, com o serviço de coleta de lixo ou com a loja em que o produto foi adquirido.



Likvidácia vyradených zariadení v domácnostiach v Európskej únii

Symbol na výrobku alebo jeho balení označuje, že daný výrobok sa nesmie likvidovať s domovým odpadom. Povinnosťou spotrebiteľa je odovzdať vyradené zariadenie v zbernom mieste, ktoré je určené na recykláciu vyradených elektrických a elektronických zariadení. Separovaný zber a recyklácia vyradených zariadení prispieva k ochrane prírodných zdrojov a zabezpečuje, že recyklácia sa vykonáva spôsobom chrániacim ľudské zdravie a životné prostredie. Informácie o zberných miestach na recykláciu vyradených zariadení vám poskytne miestne zastupiteľstvo, spoločnosť zabezpečujúca odvoz domového odpadu alebo obchod, v ktorom ste si výrobok zakúpili.



Odstranjevanje odslužene opreme uporabnikov v zasebnih gospodinjstvih v Evropski uniji

Ta znak na izdelku ali njegovi embalaži pomeni, da izdelka ne smete odvreči med gospodinjске odpadke. Nasprotno, odsluženo opremo morate predati na zbirališče, pooblaščeno za recikliranje odslužene električne in elektronske opreme. Ločeno zbiranje in recikliranje odslužene opreme prispeva k ohranjanju naravnih virov in zagotavlja recikliranje te opreme na zdravju in okolju neškodljiv način. Za podrobnejše informacije o tem, kam lahko odpeljete odsluženo opremo na recikliranje, se obrnite na pristojni organ, komunalno službo ali trgovino, kjer ste izdelek kupili.



Eliminación de residuos de equipos eléctricos y electrónicos por parte de usuarios particulares en la Unión Europea

Este símbolo en el producto o en su envase indica que no debe eliminarse junto con los desperdicios generales de la casa. Es responsabilidad del usuario eliminar los residuos de este tipo depositándolos en un "punto limpio" para el reciclado de residuos eléctricos y electrónicos. La recogida y el reciclado selectivos de los residuos de aparatos eléctricos en el momento de su eliminación contribuirá a conservar los recursos naturales y a garantizar el reciclado de estos residuos de forma que se proteja el medio ambiente y la salud. Para obtener más información sobre los puntos de recogida de residuos eléctricos y electrónicos para reciclado, póngase en contacto con su ayuntamiento, con el servicio de eliminación de residuos domésticos o con el establecimiento en el que adquirió el producto.



Bortskaffande av avfallsprodukter från användare i privathushåll inom Europeiska Unionen

Om den här symbolen visas på produkten eller förpackningen betyder det att produkten inte får slängas på samma ställe som hushållssopor. I stället är det ditt ansvar att bortskaffa avfallet genom att överlämna det till ett uppsamlingsställe avsett för återvinning av avfall från elektriska och elektroniska produkter. Separat insamling och återvinning av avfallet hjälper till att spara på våra naturresurser och gör att avfallet återvinns på ett sätt som skyddar människors hälsa och miljön. Kontakta ditt lokala kommunkontor, din närmsta återvinningsstation för hushållsavfall eller affären där du köpte produkten för att få mer information om var du kan lämna ditt avfall för återvinning.

Index

Numerics

- 10/100Base-TX ports
 - location on switch ... 1-4
- 1000Base-BX ... C-3
 - fiber-optic cable specifications ... C-3
- 1000Base-LH ... C-3
 - fiber-optic cable specifications ... C-3
- 1000Base-T
 - 1000Base-T
 - fiber-optic cable specifications ... C-3

A

- AC power connector
 - location on back of switch ... 1-12
- Act LED ... 1-7, 1-9
- air flow ... 2-4
- al module
 - install or remove ... 2-8
- al module slot ... 1-12
- auto MDI/MDI-X operation ... C-7, C-9
 - HP Auto-MDIX feature ... C-6

B

- back of switch
 - al module slot ... 1-12
 - description ... 1-12
 - power connector ... 1-13
 - RPS input port ... 1-13
- basic switch configuration
 - IP address ... 3-3
 - manager password ... 3-2
 - subnet mask ... 3-3
 - switch setup screen ... 3-2
- basic troubleshooting tips ... 4-1
- Bootp
 - automatic switch configuration ... 3-2
 - for in-band access ... 2-24
- buttons
 - Clear button ... 1-10
 - port LED view select button ... 1-8
 - Reset button ... 1-10

C

- cabinet
 - mounting the switch in ... 2-11
- cables
 - connecting cables to switch ports ... 2-27
 - effects of non-standard cables ... 4-2
 - fiber-optic, specifications ... C-3
 - infrastructure requirements ... 2-5
 - serial, for direct console connection ... 2-25
- cables, twisted pair
 - category 3, 4, 5 ... C-6
 - cross-over cable pin-out ... C-8
 - MDI-X to MDI connections ... C-7, C-9
 - MDI-X to MDI-X connections ... C-8
 - pin-outs ... C-7, C-9
 - straight-through cable pin-out ... C-7, C-9
 - switch-to-computer connection ... C-7, C-9
 - switch-to-switch or hub connection ... C-8
- cables, twisted-pair
 - HP Auto-MDIX feature ... C-6
 - wiring rules ... C-6
- cables, twisted-pair connector pin-outs ... C-6
- cabling infrastructure ... 2-5
- Clear button
 - deleting passwords ... 1-10
 - description ... 1-10
 - location on switch ... 1-4, 1-10
 - restoring factory default configuration ... 1-10, 4-11
 - to delete password protection ... 3-4
- CLI prompt, console
 - displaying ... 2-25
- configuration
 - checking when troubleshooting ... 4-3
 - DHCP/Bootp ... 3-2
 - full duplex only for mini-GBICs ... 2-16
 - IP address ... 3-3
 - IP address, manually ... 3-2
 - manager password ... 3-2
 - restoring factory defaults ... 1-10, 4-11
 - subnet mask ... 3-3
 - switch setup screen ... 3-2
- connecting
 - external power supply ... 2-18
- connecting the switch to a power source ... 2-18

console
 checking messages during
 troubleshooting ... 4-9
 displaying the CLI prompt ... 2-25
 features ... 2-24
 how to connect in-band ... 2-24
 how to connect out-of-band ... 2-24
 serial cable connection ... 2-25
 switch setup screen ... 3-2
 telnet access ... 3-5
 terminal configuration ... 2-25

console port
 definition ... 1-11
 location on switch ... 1-4

cross-over cable
 pin-out ... C-8

D

deleting passwords ... 1-10

description
 back of switch ... 1-12
 front of switch ... 1-4
 LEDs ... 1-6
 switch ... 1-1

DHCP
 automatic switch configuration ... 3-2
 for in-band access ... 2-24

diagnostic tests ... 4-9
 checking the console messages ... 4-9
 checking the LEDs ... 4-9
 end-to-end connectivity ... 4-10
 testing the switch only ... 4-9
 testing twisted-pair cabling ... 4-10

downloading new switch software ... 4-12

dual-personality ports
 location on switch ... 1-6
 operation description ... 1-6

E

electrical specifications, switch ... A-1

EMC regulatory statements ... D-8

environmental specifications, switch ... A-1, B-1

EPS input port ... 1-13

expansion module LEDs ... 1-11

external power supply
 connecting ... 2-18

F

factory default configuration, restoring ... 1-10, 4-11

Fan Status LED ... 1-8, 2-20, 2-23

fan Status LED ... 1-8

Fault LED ... 2-20, 2-23
 behavior during self test ... 2-7
 behaviors ... 2-20, 2-23
 flashing definition ... 2-20, 2-23
 location on switch ... 1-4
 showing error conditions ... 4-4

fault LED ... 1-6
 behaviors ... 1-6
 flashing definition ... 1-8, 1-11

FDx LED ... 1-7, 1-9

features
 console ... 2-24
 switch ... 1-16

fiber-optic cables ... C-3
 1000Base-BX ... C-3
 1000Base-LH ... C-3
 1000Base-T ... C-3

flashing LEDs
 error indications ... 4-4

front of switch ... 1-4
 10/100Base-TX ports ... 1-4
 Clear button ... 1-10
 description ... 1-4
 dual-personality ports ... 1-6
 LEDs ... 1-6
 network ports ... 1-6
 port LED view select button and LEDs ... 1-8
 Reset button ... 1-10

full-duplex fixed configuration
 effects on network connections ... 4-1

full-duplex operation of mini-GBICs ... 2-16

G

gigabit edge switch
 sample topology ... 2-29

H

horizontal surface
 mounting switch on ... 2-13

HP Auto-MDIX
 feature description ... C-6

I

- in-band ... 3-1
- in-band console access
 - types of ... 2-24
- included parts ... 2-1
- installation
 - al module ... 2-8
 - connecting the switch to a power source ... 2-18
 - horizontal surface mounting ... 2-13
 - location considerations ... 2-5
 - network cable requirements ... 2-5
 - precautions ... 2-3
 - rack or cabinet mounting ... 2-11
 - site preparation ... 2-5
 - summary of steps ... 2-4
 - transceiver ... 2-14
- IP address
 - configuring ... 3-3

L

- LEDs
 - Act ... 1-7, 1-9
 - behavior during self test ... 2-7
 - checking during troubleshooting ... 4-9
 - descriptions of ... 1-6
 - error indications ... 4-4
 - Fan Status ... 1-8, 2-20, 2-23
 - fan status ... 1-8
 - Fault ... 2-20, 2-23
 - behavior during self test ... 2-7
 - showing error conditions ... 4-4
 - fault ... 1-6
 - FDx ... 1-7, 1-9
 - flashing definition ... 1-8, 1-11, 2-20, 2-23
 - Link ... 1-7, 1-11
 - location on switch ... 1-4
 - on switch ... 1-6
 - PoE ... 1-7
 - port
 - description ... 1-7
 - port description ... 2-20, 2-23
 - Port LED View select indicators ... 1-7
 - Port View
 - selecting the display ... 1-8
 - Power ... 1-6, 2-20, 2-23
 - behavior during self test ... 2-7
 - Self Test ... 1-7

- behavior during self test ... 2-7
- Spd ... 1-7
- Temp Status ... 2-20, 2-23
- Usr ... 1-7
- LEDs, expansion module ... 1-11
- LEDs, RPS/EPS ... 2-19, 2-22
- Link LEDs ... 1-7, 1-11
- link test ... 4-10
- location for the switch, considerations ... 2-5

M

- MDI-X to MDI network cable ... C-7, C-9
- MDI-X to MDI-X network cable ... C-8
- mini-GBICs
 - full-duplex operation ... 2-16
 - slot, location on switch ... 1-4
- mounting the switch
 - in a rack or cabinet ... 2-11
 - precautions ... 2-3
 - on a horizontal surface ... 2-13

N

- network cables
 - fiber-optic, specifications ... C-3
 - HP Auto-MDIX feature ... C-6
 - required types ... 2-5
 - twisted-pair connector pin-outs ... C-6
 - twisted-pair, wiring rules ... C-6
- network devices
 - connecting to the switch ... 2-27
- network ports
 - connecting to ... 2-27
 - location on switch ... 1-6
 - types of ... 1-6
- non-standard network cables, effects ... 4-2

O

- out-of-band console access ... 3-5

P

- parts, included with the switch ... 2-1
- password
 - configuring ... 3-2
- passwords
 - deleting with the Clear button ... 3-4
 - if you lose the password ... 3-4

- passwords, deleting ... 1-10
- physical specifications, switch ... A-1
- Ping test ... 4-10
- pin-outs
 - twisted-pair cables ... C-6
- PoE LEDs ... 1-7
- PoE+ ... 1-3
- port configuration
 - checking when troubleshooting ... 4-3
- Port LED View
 - indicator LEDs ... 1-8
 - select button ... 1-8
 - selecting the display ... 1-8
- port LEDs
 - description ... 1-7, 2-20, 2-23
 - Link ... 1-7, 1-11
 - normal operation ... 2-7
- ports
 - 10/100Base-TX, location on switch ... 1-4–1-5
 - connecting to ... 2-27
 - console ... 2-24
 - HP Auto-MDIX feature ... C-6
 - network connections ... 2-27
- power connector ... 1-13
- power cords ... 2-2
- Power LED ... 1-6, 2-20, 2-23
 - behavior during self test ... 2-7
 - behaviors ... 1-6, 2-20, 2-23
 - location on switch ... 1-4
- power source
 - connecting the switch to ... 2-18
- precautions
 - mounting the switch ... 2-3
 - power requirements ... 2-3
- preparing the installation site ... 2-5
- pre-standard PoE devices ... 1-3
- Proactive Network tools
 - diagnostics with ... 4-8

R

- rack
 - mounting precautions ... 2-3
 - mounting the switch in ... 2-11
- rack mounting ... 2-3, 2-11
- rail kit ... 2-1, 2-3
- recycle statements ... E-1
- regulatory statements ... D-8

- Reset button
 - description ... 1-10
 - location on switch ... 1-4, 1-10
 - restoring factory default configuration ... 4-11
- resetting the switch
 - factory default reset ... 4-11
 - location of Reset button ... 1-10
 - troubleshooting procedure ... 4-9
- RPS/EPS connectivity ... 2-21, 2-24
- RPS/EPS LEDs ... 2-19, 2-22

S

- safety and regulatory statements ... D-1
- safety specifications ... A-2
- selecting the Port LED View display ... 1-8
- self test
 - Fault LED behavior ... 2-7
 - LED behavior during ... 2-7
 - Power LED behavior ... 2-7
- Self Test LED ... 1-7
 - behavior during factory default reset ... 4-11
- serial cable
 - for direct console connection ... 2-25
- SFP+ ... 1-2
- slots for mini-GBICs
 - location on switch ... 1-4
- Spd LEDs ... 1-7
- specifications
 - cabling ... C-1
 - distance ... C-3
 - electrical ... A-1
 - environmental ... A-1, B-1
 - physical ... A-1
 - safety ... A-2
- straight-through cable
 - pin-out ... C-7, C-9
- subnet mask
 - configuring ... 3-3
- summary
 - of switch installation ... 2-4

- switch
 - connecting to a power source ... 2-18
 - description ... 1-1
 - downloading new software ... 4-12
 - electrical specifications ... A-1
 - environmental specifications ... A-1, B-1
 - features ... 1-16
 - front panel description ... 1-4
 - included parts ... 2-1
 - LED descriptions ... 1-6
 - mounting in a rack or cabinet ... 2-11
 - mounting on horizontal surface ... 2-13
 - physical specifications ... A-1
- switch operation
 - verifying after installation ... 2-5
- Switch Setup screen
 - configuring a subnet mask ... 3-3
 - configuring an IP address ... 3-3
 - field descriptions ... 3-3
- switch setup screen ... 3-2

T

- technology distance specifications ... C-3
- telnet access to the console ... 3-5
- Temp Status LED ... 2-20, 2-23
- terminal configuration ... 2-25
- Test LED
 - behavior during self test ... 2-7
- testing
 - checking the console messages ... 4-9
 - checking the LEDs ... 4-9
 - diagnostic tests ... 4-9
 - end-to-end communications ... 4-10
 - link test ... 4-10
 - Ping test ... 4-10
 - switch operation ... 4-9
 - switch-to-device communications ... 4-10
 - twisted-pair cabling ... 4-10
- tips for troubleshooting ... 4-1
- topologies
 - effects of improper topology ... 4-2
 - samples of ... 2-29
- transceiver
 - install or remove ... 2-14

- transceivers SFP+ ... 1-2
- troubleshooting ... 4-1
 - basic tips ... 4-1
 - checking port configuration ... 4-3
 - checking the console messages ... 4-9
 - checking the LEDs ... 4-9
 - common network problems ... 4-1
 - connecting to fixed full-duplex devices ... 4-1
 - diagnostic tests ... 4-9
 - effects of improper topology ... 4-2
 - effects of non-standard cables ... 4-2
 - link test ... 4-10
 - Ping test ... 4-10
 - Proactive Network tools ... 4-8
 - restoring factory default configuration ... 4-11
 - testing connections to other devices ... 4-10
 - testing end-to-end communications ... 4-10
 - testing the switch ... 4-9
 - testing the twisted-pair cables ... 4-10

- twisted-pair cable
 - cross-over cable pin-out ... C-8
 - pin-outs ... C-6–C-7, C-9
 - straight-through cable pin-out ... C-7, C-9
 - switch-to-computer connection ... C-7, C-9
 - switch-to-switch or hub connection ... C-8
 - testing ... 4-10
- twisted-pair ports
 - HP Auto-MDIX feature ... C-6

U

- Usr LEDs ... 1-7

V

- voltage ranges ... 2-6
- VT-100 terminal
 - serial cable connection for ... 2-25

W

- wiring rules for twisted-pair cables ... C-6

Technology for better business outcomes

To learn more, visit www.hp.com/go/procurve/

© Copyright 2009-2010 Hewlett-Packard Development Company, L.P. The information contained herein is subject to change without notice. The only warranties for HP products and services are set forth in the express warranty statements accompanying such products and services. Nothing herein should be construed as constituting an additional warranty. HP will not be liable for technical or editorial errors or omissions contained herein.



March 2010

Manual Part Number
5992-3084

