

adaptec[®]

Adaptec Storage Manager

User's Guide for Internal RAID Storage

Copyright

©2005-2007 Adaptec, Inc. All rights reserved. No part of this publication may be reproduced, stored in a retrieval system, or transmitted in any form or by any means, electronic, mechanical, photocopying, recording or otherwise, without the prior written consent of Adaptec, Inc., 691 South Milpitas Blvd., Milpitas, CA 95035.

Trademarks

Adaptec, Storage Manager, and the Adaptec logo are trademarks of Adaptec, Inc., which may be registered in some jurisdictions.

Microsoft and Windows are trademarks of Microsoft Corporation in the US and other countries, used under license.

Red Hat is a trademark of Red Hat, Inc. in the US and other countries, used under license.

Novell and NetWare are trademarks of Novell, Inc. in the US and other countries, used under license.

SCO and OpenServer are trademarks of The SCO Group, Inc. in the US and other countries, used under license.

UnixWare is a registered trademark of The Open Group in the United States and other countries, used under license.

All other trademarks are the property of their respective owners.

Changes

The material in this document is for information only and is subject to change without notice. While reasonable efforts have been made in the preparation of this document to assure its accuracy, Adaptec, Inc. assumes no liability resulting from errors or omissions in this document, or from the use of the information contained herein.

Adaptec reserves the right to make changes in the product design without reservation and without notification to its users.

Disclaimer

IF THIS PRODUCT DIRECTS YOU TO COPY MATERIALS, YOU MUST HAVE PERMISSION FROM THE COPYRIGHT OWNER OF THE MATERIALS TO AVOID VIOLATING THE LAW WHICH COULD RESULT IN DAMAGES OR OTHER REMEDIES.

Adaptec Customer Support

If you have questions about installing or using your Adaptec product, check this document first—you will find answers to most of your questions. If you need further assistance, use the support options listed below. To expedite your service, have your computer in front of you.

Technical Support Identification (TSID) Number

- Before contacting Technical Support, you need your unique 12-digit TSID number. The TSID number identifies your product and support status.
- The TSID number is included on a white, bar-coded label, like this example:

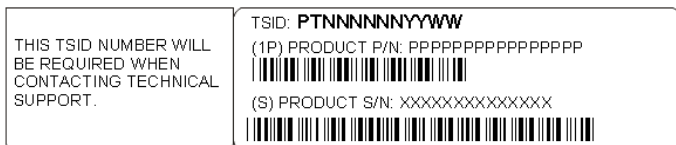

- Affix a copy of the TSID label to the CD jacket so that you don't lose it.

North America

- Visit our Web site at www.adaptec.com.
- Search the Adaptec Support Knowledgebase (ASK) at ask.adaptec.com for articles, troubleshooting tips, and frequently asked questions for your product.
- For information about Adaptec's support options, call +1 408-957-2550, 24 hours per day, 7 days per week. To speak with a Technical Support Specialist, call +1 408-934-7274 or +1 321-207-2000.
- For support via e-mail, submit your question at ask.adaptec.com.
- You can order Adaptec products, including accessories and cables, by calling +1 408-957-7274. Or, you can order cables online at www.adaptec.com/buy-cables.

Europe

- Visit our Web site at www.adaptec-europe.com.
- **German:** Call +49 89 43 66 55 22. For support via e-mail, submit your question at ask-de.adaptec.com.
- **French:** Call +49 89 43 66 55 33. For support via e-mail, submit your question at ask-fr.adaptec.com.
- **English:** Call +49 89 43 66 55 44. For support via e-mail, submit your question at ask.adaptec.com.
- You can order Adaptec cables online at www.adaptec.com/buy-cables.

Japan

- Visit our Web site at www.adaptec.co.jp.
- Call +81-3-3831-5190.

Software License Agreement

PLEASE READ CAREFULLY: THE USE OF THIS SOFTWARE IS SUBJECT TO THE SOFTWARE LICENSE TERMS OF ADAPTEC, INC. AND OTHER LICENSORS WHOSE SOFTWARE MAY BE BUNDLED WITH THIS PRODUCT.

BY YOUR USE OF THE SOFTWARE INCLUDED WITH THIS PRODUCT YOU AGREE TO THE LICENSE TERMS REQUIRED BY THE LICENSOR OF THAT SOFTWARE, AS SET FORTH DURING THE INSTALLATION PROCESS. IF YOU DO NOT AGREE TO THE LICENSE TERMS APPLICABLE TO THE SOFTWARE, YOU MAY RETURN THE ENTIRE UNUSED PRODUCT FOR A FULL REFUND.

In return for acquiring a license to use the Adaptec software ("Software") and the related documentation, you agree to the following terms and conditions:

1. License. This Agreement grants you, the Licensee, a license to:
 - Use the Software on a single computer system or on multiple workstations, systems and servers which incorporate an Adaptec RAID controller and may be accessed by multiple users from multiple locations. You may make as many installations of the Software as needed, but must restrict such installation only to systems, workstations or servers using an Adaptec RAID controller.
 - Make one copy of the Software in machine readable form solely for back-up purposes provided you reproduce Adaptec's copyright notice and any proprietary legends.
2. Restrictions. You may not distribute copies of the Software to others. You may not post or otherwise make available the Software, or any portion thereof, in any form, on the Internet. You may not use the Software in a computer service business, including in time sharing applications. The Software contains trade secrets and, in order to protect them, you may not decompile, reverse engineer, disassemble, or otherwise reduce the Software to a human-perceivable form. YOU MAY NOT MODIFY, ADAPT, TRANSLATE, RENT, LEASE, LOAN, RESELL FOR PROFIT, DISTRIBUTE, NETWORK OR CREATE DERIVATIVE WORKS BASED UPON THE SOFTWARE OR ANY PART THEREOF.
3. Ownership of Software. As Licensee, you own the media upon which the software is recorded or fixed, but Adaptec and its licensors retain title and ownership of the Software recorded on the original media and all subsequent copies of the Software, regardless of the form or media in which or on which the original and other copies may exist. This license is not a sale of the Software or any copy.
4. Confidentiality. You agree to maintain the Software in confidence and that you will not disclose the Software to any third party without the express written consent of Adaptec. You further agree to take all reasonable precautions to preclude access of unauthorized persons to the Software.
5. Term. This license is effective until January 1, 2045, unless terminated earlier. You may terminate the license at any time by destroying the Software (including the related documentation) together with all copies or modifications in any form. Adaptec will have the right to terminate our license immediately if you fail to comply with any term or condition of this Agreement. Upon any termination, including termination by you, you must destroy the Software (including the related documentation), together with all copies or modifications in any form.
6. Special Terms Applicable to Databases. Where a database is included with the Software, you acknowledge that it is licensed only in connection with the use of the Software to perform disc creation, and that the database and all data derived therefrom must be maintained in confidence in accordance with the provisions of Section 4. This license does not grant you any rights to distribute or disclose such database or data.
7. Limited Warranty. Adaptec and its Licensor warrant only that the media upon which the Software is furnished will be free from defects in material or workmanship under normal use and service for a period of thirty (30) days from the date of delivery to you. ADAPTEC AND ITS LICENSORS DO NOT AND CANNOT WARRANT THE PERFORMANCE OR RESULTS YOU MAY OBTAIN BY USING THE SOFTWARE OR DOCUMENTATION. THE FOREGOING STATES THE SOLE AND EXCLUSIVE REMEDIES ADAPTEC AND ITS LICENSORS WILL PROVIDE FOR BREACH OF WARRANTY. EXCEPT FOR THE FOREGOING LIMITED WARRANTY, ADAPTEC AND ITS LICENSORS MAKE NO WARRANTIES, EXPRESSED OR IMPLIED, INCLUDING, BUT NOT LIMITED, AS TO NON-INFRINGEMENT OF THIRD PARTY RIGHTS, MERCHANTABILITY OR FITNESS FOR A PARTICULAR PURPOSE. Some states do not allow the exclusion of implied warranties or limitations on how long an implied warranty may last, so the above limitations may not apply to you. This warranty gives you specific legal rights and you may also have other rights which vary from state to state.
8. The entire liability of Adaptec and its licensors, and your exclusive remedy for a breach of this warranty, shall be:
 - The replacement of any media not meeting the above limited warranty which is returned to Adaptec; or
 - If Adaptec or its distributor is unable to deliver replacement media which is free from defects in materials or workmanship, you may terminate this Agreement by returning the Software and your money will be refunded.
9. Limitation of Liability. IN NO EVENT WILL ADAPTEC OR ITS LICENSORS BE LIABLE TO YOU FOR ANY INCIDENTAL, CONSEQUENTIAL OR INDIRECT DAMAGES, INCLUDING ANY LOST PROFITS, LOST SAVINGS, OR LOSS OF DATA, EVEN IF ADAPTEC OR A LICENSOR HAS BEEN ADVISED OF THE POSSIBILITY OF SUCH DAMAGES, OR FOR ANY CLAIM BY ANY OTHER PARTY. Some states do not allow the exclusion or limitation of special, incidental, or consequential damages, so the above limitation or exclusion may not apply to you.

10. Export. You acknowledge that the laws and regulations of the United States and other countries may restrict the export and re-export of the Software. You agree that you will not export or re-export the Software or documentation in any form in violation of applicable United States and foreign law.
11. Government Restricted Rights. The Software is subject to restricted rights as follows. If the Software is acquired under the terms of a GSA contract: use, reproduction or disclosure is subject to the restrictions set forth in the applicable ADP Schedule contract. If the Software is acquired under the terms of a DoD or civilian agency contract, use, duplication or disclosure by the Government is subject to the restrictions of this Agreement in accordance with i C.F.R. 12.212 of the Federal Acquisition Regulations and its successors and 49 C.F.R. 227.7202-1 of the DoD FAR Supplement and its successors.
12. General. You acknowledge that you have read this Agreement, understand it, and that by using the Software you agree to be bound by its terms and conditions. You further agree that it is the complete and exclusive statement of the agreement between Adaptec and you, and supersedes any proposal or prior agreement, oral or written, and any other communication between Adaptec and you relating to the subject matter of this Agreement. No additional or any different terms will be enforceable against Adaptec unless Adaptec gives its express consent, including an express waiver of the terms of this Agreement, in writing signed by an officer of Adaptec. You assume full responsibility for the use of the Software and agree to use the Software legally and responsibly. This Agreement shall be governed by California law, except as to copyright matters, which are covered by Federal law. This Agreement is deemed entered into at Milpitas, California by both parties. Should any provision of this Agreement be declared unenforceable in any jurisdiction, then such provision shall be deemed severable from this Agreement and shall not affect the remainder hereof. All rights in the Software not specifically granted in this Agreement are reserved by Adaptec.

Should you have any questions concerning this Agreement, you may contact Adaptec by writing to:

Adaptec, Inc.
Legal Department
691 South Milpitas Boulevard
Milpitas, California 95035.

Contents

About This Guide

How This Guide is Organized	14
What You Need to Know Before You Begin	14
Terminology Used in this Guide	14

Part I: Getting Started

Introduction to Adaptec Storage Manager

Getting Started Checklist	17
About Adaptec Storage Manager	17
About the Adaptec Storage Manager Agent	17
Growing Your Storage Space with Adaptec Storage Manager.....	18
A Simple Storage Space	18
An Advanced Storage Space.....	18
Continuing to Grow Your Storage Space.....	19
Adding Enhanced Features	20
Unlocking the Enhanced Features.....	20
System Requirements.....	21

Installing and Starting Adaptec Storage Manager

Installing Adaptec Storage Manager	23
Installing on Windows	23
Completing a Silent Windows Installation (Advanced)	24
Installing on Linux	25
Installing on NetWare.....	26
Installing on UnixWare or OpenServer	26
Installing on Solaris.....	27

Using Adaptec Storage Manager on VMWare.....	27
Starting Adaptec Storage Manager.....	28
Starting Adaptec Storage Manager on Windows.....	28
Starting Adaptec Storage Manager on Linux.....	29
Starting Adaptec Storage Manager on NetWare	29
Starting Adaptec Storage Manager on UnixWare or OpenServer	29
Starting Adaptec Storage Manager on Solaris.....	29
Starting the Adaptec Storage Manager Agent Only	30
Starting the Agent on Windows	30
Starting the Agent on Linux.....	30
Starting the Agent on NetWare	31
Starting the Agent on UnixWare or OpenServer.....	31
Starting the Agent on Solaris	31
Using Adaptec Storage Manager with a Firewall.....	31
Understanding Permission Levels.....	32
Administrator Level	32
User Level.....	32
Guest Level.....	32
Configuring NetWare User Authentication	33
Logging Out of Adaptec Storage Manager.....	34
Logging Back In.....	34
Running Adaptec Storage Manager from the CD	34
When to Choose Bootable-CD Mode	34
Getting Started in Bootable-CD Mode	35
Running Adaptec Storage Manager from the CD	35

Exploring Adaptec Storage Manager

Navigating the Main Window	38
Using the Enterprise View	39
Using the Physical Devices View	40
Using the Logical Devices View.....	41
Revealing More Disk Drive Information	42
Checking System Status	43
Working in Adaptec Storage Manager.....	44
About the Actions Menu	44
Getting Help	44

Building Your Storage Space

Selecting a Configuration Method.....	46
Express Configuration: Building the Easy Way.....	46
Partitioning and Formatting Your Logical Drives.....	48
Including More Systems in Your Storage Space.....	49

Custom Configuration (Advanced)	49
Including More Systems in Your Storage Space	53
Building a RAID Volume.....	54
RAID Controller Support	55
Managing Your Storage Space.....	56

Customizing Adaptec Storage Manager

Logging In to Remote Systems	58
Removing a Remote System	59
Creating Display Groups	60
Setting Preferences and Changing Views.....	61
Sorting Systems in the Enterprise View	61
Setting the Standard Unit of Measure	62
Changing the Main Window Appearance	62
Customizing the Adaptec Storage Manager Agent	62
Broadcasting Event Alerts from a System	63
Changing a System's Event Log Setting	63
Changing a System's Audible Alarm Settings	64
Changing a System's Agent Base Port Number	64

Part II:Using Adaptec Storage Manager

Managing Logical Drives and Hot Spares

Understanding Logical Drives	67
Creating Logical Drives.....	68
Setting the Size of a Logical Drive	68
Including Different-sized Disk Drives in a Logical Drive	69
Creating a Logical Drive Using Available Space	70
Fine-tuning Logical Drives	71
Renaming a Logical Drive	71
Adjusting a Logical Drive's Advanced Settings.....	71
Changing the Stripe Size	72
Changing the Write Cache Setting	72
Changing the Read Cache Setting	73
Changing the Initialize Priority	73
Changing the Initialize Method.....	73
Verifying Logical Drives	74
Verifying and Fixing a Logical Drive.....	75
Verifying a Logical Drive (Without Fix)	76
Enabling/Disabling Background Consistency Check	76
Increasing the Capacity of a Logical Drive	77

Extending a Partition on a Logical Drive.....	78
Changing the RAID Level of a Logical Drive.....	79
Deleting a Logical Drive.....	80
Working with Hot Spares	81
Hot Spare Limitations.....	81
Dedicated Spare or Global Spare?	81
Designating a Global Hot Spare	82
Assigning a Dedicated Hot Spare or Pool Hot Spare	83
What Do the Hot Spare Icons Mean?.....	83
Removing or Deleting a Dedicated Hot Spare.....	84
Deleting a Global Hot Spare	84

Protecting Your Data

Creating a Snapshot	87
Snapshot Limitations	87
Creating a Snapshot with Backup.....	88
Creating a Snapshot Without Backup.....	88
Deleting a Snapshot.....	89
Enabling Copyback	89

Monitoring Your Storage Space

Monitoring Options.....	91
Checking Activity in Your Storage Space	91
Viewing the Full List of Events	92
Clearing the Event Log.....	92
What Do the Status Icons Mean?	92
Using Notifications to Monitor Status	93
Setting up Event Notifications.....	93
Managing the Event Notification List	96
Monitoring and Managing the Notification Log.....	97
Disabling Event Notifications.....	98
Setting Up Email Notifications.....	99
Managing the Email List	102
Monitoring and Managing the Email Log	103
Changing the Email Notification Manager Settings.....	104
Disabling Email Notifications.....	105
Broadcasting Event Alerts to Users	105
Managing Enclosure Status	106
Silencing and Testing the Audible Alarm	107
Enabling a System's Alarm.....	107
Testing the Alarm.....	108
Silencing the Alarm	108

Managing Tasks

Scheduling a Task.....	110
Opening the Task Manager	111
Monitoring Tasks.....	112
Monitoring Upcoming Tasks in the Task List.....	112
Checking Past Tasks and Events in the Event Log.....	112
Modifying a Task.....	113
What if a task misses its start time?	113
Deleting a Task.....	114
Disabling the Task Manager	114
Re-enabling the Task Manager	115

Working with Display Groups

Adding a System to a Display Group	117
Viewing Display Group Status	117
Moving a System from One Display Group to Another	118
Renaming a Display Group	118
Removing a System from a Display Group	119
Deleting a Display Group	119

Managing Controllers, Disk Drives, and Enclosures

Viewing Component Properties.....	121
Blinking a Component.....	121
Managing Disk Drives.....	122
Replacing Disk Drives in a Logical Drive.....	122
Setting a Disk Drive to 'Failed'	122
Initializing Disk Drives	123
Managing Controllers.....	124
Registering New Controllers.....	124
Testing a Controller Alarm.....	124
Silencing a Controller Alarm.....	125
Disabling a Controller Alarm	125
Rescanning a Controller	125
Saving Your Controller Configuration	126
Managing Enclosures.....	126
Testing an Enclosure Alarm.....	126
Silencing an Enclosure Alarm.....	127
Disabling an Enclosure Alarm	127
Updating Controller BIOS and Firmware	128
Before You Begin.....	128
Updating the Controller BIOS and Firmware	128

Configuring SNMP Support

Configuring SNMP Support on Windows	131
Configuring SNMP Support on Linux	132
Configuring SNMP Support on NetWare	132

Solving Problems

Troubleshooting Adaptec Storage Manager	134
Identifying a Failed or Failing Component	134
Recovering from a Disk Drive Failure	135
Failed Disk Drive Protected by a Hot Spare	135
Failed Disk Drive <i>Not</i> Protected by a Hot Spare	136
Failure in Multiple Logical Drives Simultaneously	136
Disk Drive Failure in a RAID 0 Logical Drive	136
Multiple Failures in the Same Logical Drive.....	137
Removing a Failed Disk Drive's Icon	137
Rebuilding Logical Drives.....	137
Solving Notification Problems	138
Creating a Support Archive File	138
Understanding Error and Warning Messages	139
Warning Messages.....	139
Error Messages.....	139

Part III:Quick Reference

Quick Answers to Common Questions...

How do I...?	147
Set up my storage space?	147
Create or add a new logical drive?	147
Open the Configuration wizard?	147
Turn off the alarm?.....	147
Add a new user to Adaptec Storage Manager?.....	147
Add a remote system?.....	147
Prevent a user from changing my storage space?	147
Check disk drive or logical drive status?	147
Access a feature with a padlock icon beside it?	147
Log out of Adaptec Storage Manager?	148
Schedule a task?	148
Find the Task Manager?	148
Find the Notification Manager?.....	148
Find the Email Notification Manager?	148
What's the difference between...?	149

Adaptec Storage Manager and the Agent?	149
Internal RAID and External RAID branches of the Enterprise View?	149
Event notifications, email notifications, and event alerts?	149
What options are on the Actions menu?	150
Local and remote systems	150
Controllers?.....	150
Disk drives?	150
Enclosures?.....	151
Logical drives?.....	151
Internal RAID storage?.....	151
The Notification Manager?.....	151
The Email Notification Manager?	152
The Task Manager?	152
What tasks can be scheduled to run at a specified time?	152

Buttons and Icons At-a-Glance

Enterprise View Icons	154
Icons in the Physical Devices View	154
Enclosure Status Icons	154
Icons in the Logical Devices View	155
Buttons in the Main Window	155
Buttons in the Notification Manager	156
Buttons in the Email Notification Manager	156
Buttons in the Task Manager	156

Selecting the Best RAID Level

Comparing RAID Levels.....	158
Understanding Drive Segments	158
Non-redundant Logical Drives (RAID 0).....	159
RAID 1 Logical Drives	160
RAID 1 Enhanced Logical Drives.....	160
RAID 10 Logical Drives	161
RAID 5 Logical Drives	162
RAID 5EE Logical Drives.....	163
RAID 50 Logical Drives	164
RAID 6 Logical Drives	165
RAID 60 Logical Drives	165

Glossary

Index

About This Guide

Adaptec[®] Storage Manager[™] is a software application that helps you build a storage space using Adaptec RAID controllers, disk drives, and enclosures, and then manage your stored data, whether you have a single RAID controller installed in a server or a complex Storage Area Network (SAN) or IPSAN with multiple RAID controllers, enclosures, and servers.

You can use Adaptec Storage Manager to manage both internal and external RAID storage. This *User's Guide* describes how to install and use Adaptec Storage Manager to build and manage *internal RAID* storage—a RAID controller and disk drives which reside inside, or are directly attached to, the computer accessing them, similar to the basic configurations shown in these figures:

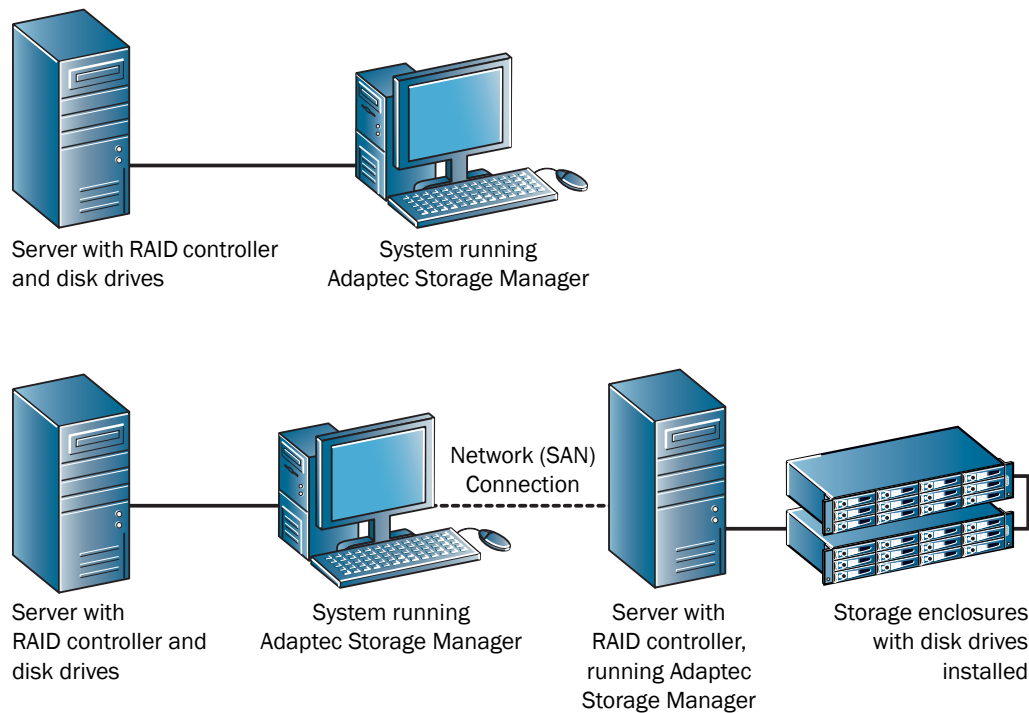

Note: For more information about using Adaptec Storage Manager to create and manage external RAID storage, such as an IPSAN, refer to the Adaptec Web site at www.adaptec.com.

How This Guide is Organized

This *User's Guide* is divided into three sections:

- **Part I: *Getting Started***—Follow the five steps in this section to install Adaptec Storage Manager and build and customize your storage space. (For a definition of ‘storage space’ and other terms used in this *User's Guide*, see [page 14](#).)
- **Part II: *Using Adaptec Storage Manager***—Once your storage space is built, refer to this section for help growing, managing, monitoring, and troubleshooting your storage space and its components.
- **Part III: *Quick Reference***—Refer to this section for quick answers to common questions about Adaptec Storage Manager. A comparison of RAID levels is also included.

What You Need to Know Before You Begin

This *User's Guide* is written for advanced computer users who want to create a storage space for their data. Advanced knowledge of storage networks is not required, but you should be familiar with computer hardware, data storage, and Redundant Array of Independent Disks (RAID) technology.

If you are using Adaptec Storage Manager as part of a complex storage system, such as a SAN, you should be familiar with network administration terminology and tasks, have knowledge of Local Area Network (LAN), Direct-Attached Storage (DAS), and SAN technology, and be familiar with the input/output (I/O) technology—such as Fibre Channel (FC), iSCSI, or Serial Attached SCSI (SAS)—that you are using on your network.

Note: Because this *User's Guide* covers multiple Adaptec RAID products, some of the features and functions described may not be available for your controller or enclosure.

Terminology Used in this Guide

Because this *User's Guide* provides information that can be used to manage multiple Adaptec RAID products in a variety of configurations from DAS to SAN, the generic term “storage space” is used to refer to the controller(s) and disk drives being managed with Adaptec Storage Manager.

For efficiency, the term “components” or “component” is used when referring generically to the physical and virtual parts of your storage space, such as systems, disk drives, controllers, and logical drives.

Many of the terms and concepts referred to in this *User's Guide* are known to computer users by multiple names. In this *User's Guide*, this terminology is used:

- Controller (also known as adapter, HBA, board, or card)
- Disk drive (also known as hard disk, hard drive, or hard disk drive)
- Logical drive (also known as logical device)
- System (also known as a server, workstation, or computer)
- Enclosure (also known as a JBOD, storage enclosure, or disk enclosure)
- Internal RAID storage (also known as direct-attached storage or DAS)

Note: For more terminology information, see the [Glossary on page 166](#).

Part I: Getting Started

- Step 1:** **Introduction to Adaptec Storage Manager** (page 16)
- Step 2:** **Installing and Starting Adaptec Storage Manager** (page 22)
- Step 3:** **Exploring Adaptec Storage Manager** (page 37)
- Step 4:** **Building Your Storage Space** (page 45)
- Step 5:** **Customizing Adaptec Storage Manager** (page 57)



STEP
1

Introduction to Adaptec Storage Manager

In this chapter...

Getting Started Checklist	17
About Adaptec Storage Manager	17
About the Adaptec Storage Manager Agent	17
Growing Your Storage Space with Adaptec Storage Manager.....	18
Adding Enhanced Features	20
System Requirements	21

This chapter describes Adaptec Storage Manager and the Adaptec Storage Manager Agent, explains the concept of a “storage space” and provides a checklist of getting-started tasks.

Getting Started Checklist

Part I of this *User's Guide* includes five special Getting Started chapters to help you install, start, and begin to use Adaptec Storage Manager.

- ✓ **Step 1:** Familiarize yourself with Adaptec Storage Manager and the Adaptec Storage Manager Agent (see the remainder of this chapter).
- ✓ **Step 2:** Install Adaptec Storage Manager on every system that will be part of your storage space, then start Adaptec Storage Manager—or the Adaptec Storage Manager Agent only—on those systems (see [page 23](#)).
- ✓ **Step 3:** Explore the features of Adaptec Storage Manager (see [page 37](#)).
- ✓ **Step 4:** Build your storage space (see [page 45](#)).
- ✓ **Step 5:** *Optional*—Customize Adaptec Storage Manager and the Adaptec Storage Manager Agent (see [page 57](#)).

About Adaptec Storage Manager

Adaptec Storage Manager is a software application that helps you build a storage space for your online data, using Adaptec RAID controllers, disk drives, and enclosures. Your storage space can include direct-attached—or *internal RAID*—storage (the subject of this *User's Guide*) and external RAID storage.

Note: For more information about using Adaptec Storage Manager to manage external RAID storage, such as an IPSAN, refer to the Adaptec Web site at www.adaptec.com.

With Adaptec Storage Manager, you can group disk drives into logical drives and build in redundancy to protect your data and improve system performance. You can also use Adaptec Storage Manager to monitor and manage all the controllers, enclosures, and disk drives in your storage space from a single location.

About the Adaptec Storage Manager Agent

When Adaptec Storage Manager is installed on a system, the *Adaptec Storage Manager Agent* is also installed automatically. The Agent is like a service that keeps your storage space running. It's designed to run in the background, without user intervention, and its job is to monitor and manage system health, event notifications, tasks schedules, and other on-going processes on that system. It sends notices when tasks are completed successfully, and sounds an alarm when errors or failures occur on that system.

The Agent uses less memory than the full application. If your storage space includes systems that won't be connected to monitors (and therefore won't require the user interface described in this *User's Guide*), you can choose to run the *Agent only* on those systems instead of the full application (see [page 17](#)). You may want to do this if system resources are limited, or if you want more system resources available for other tasks.

Note: Linux or Unix users only—If your storage space includes systems without X-Windows installed or running, you can run the Agent, even though you can't run the full Adaptec Storage Manager application.

You can manage and monitor systems running the Agent only by logging into them as remote systems (see [page 58](#)).

You can also customize the Agent settings to suit your storage space requirements (see [page 62](#)).

Growing Your Storage Space with Adaptec Storage Manager

As your requirements change, Adaptec Storage Manager grows with your storage space as you add more controllers, more disk drives, more logical drives, and more data protection.

A Simple Storage Space

This example shows a simple storage space that might be appropriate in a home office or for a small business. This storage space includes one RAID controller and three disk drives installed in a server. For data protection, the disk drives have been used to build a RAID 5 logical drive.

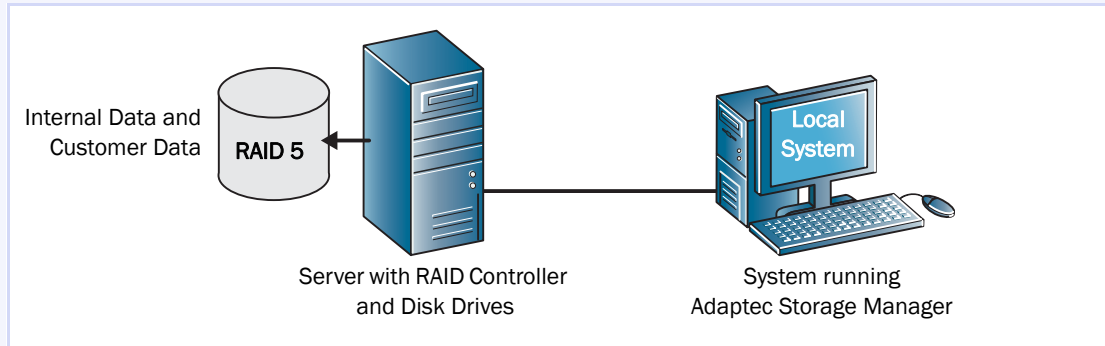

An Advanced Storage Space

This example shows how you can grow your storage space to meet the expanding requirements of your business. On the first server, segments of space from each disk drive have been used to build two RAID 5 logical drives. A second server connected to two 12-disk-drive enclosures has been added. The additional storage space has been used to create two RAID 50 logical drives. The Administrator of this storage space can create and modify logical drives and monitor both controllers, disk drives, and enclosures from a single system, called the *local* system (see [page 58](#)).

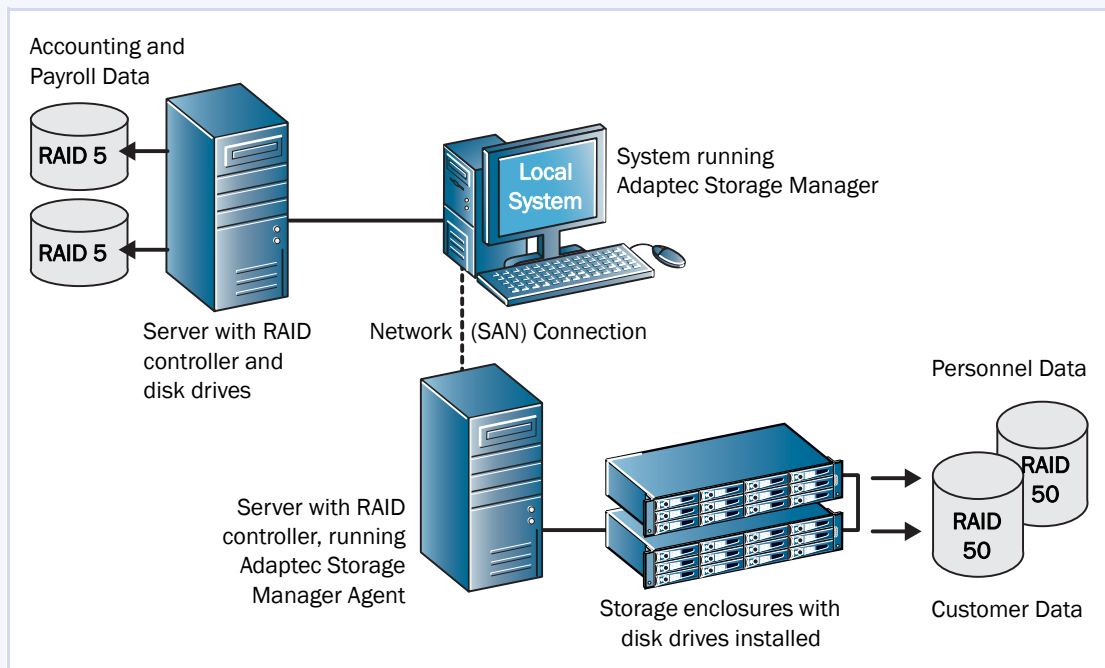

Continuing to Grow Your Storage Space

As your needs change, Adaptec Storage Manager will help you grow your storage space to include multiple controllers, storage enclosures, and disk drives in multiple locations.

In this example, multiple systems, servers, disk drives, and enclosures have been added to the storage space. The Administrator can create and modify logical drives and monitor all the controllers, enclosures, and disk drives in the storage space from the *local* system (see [page 58](#)).

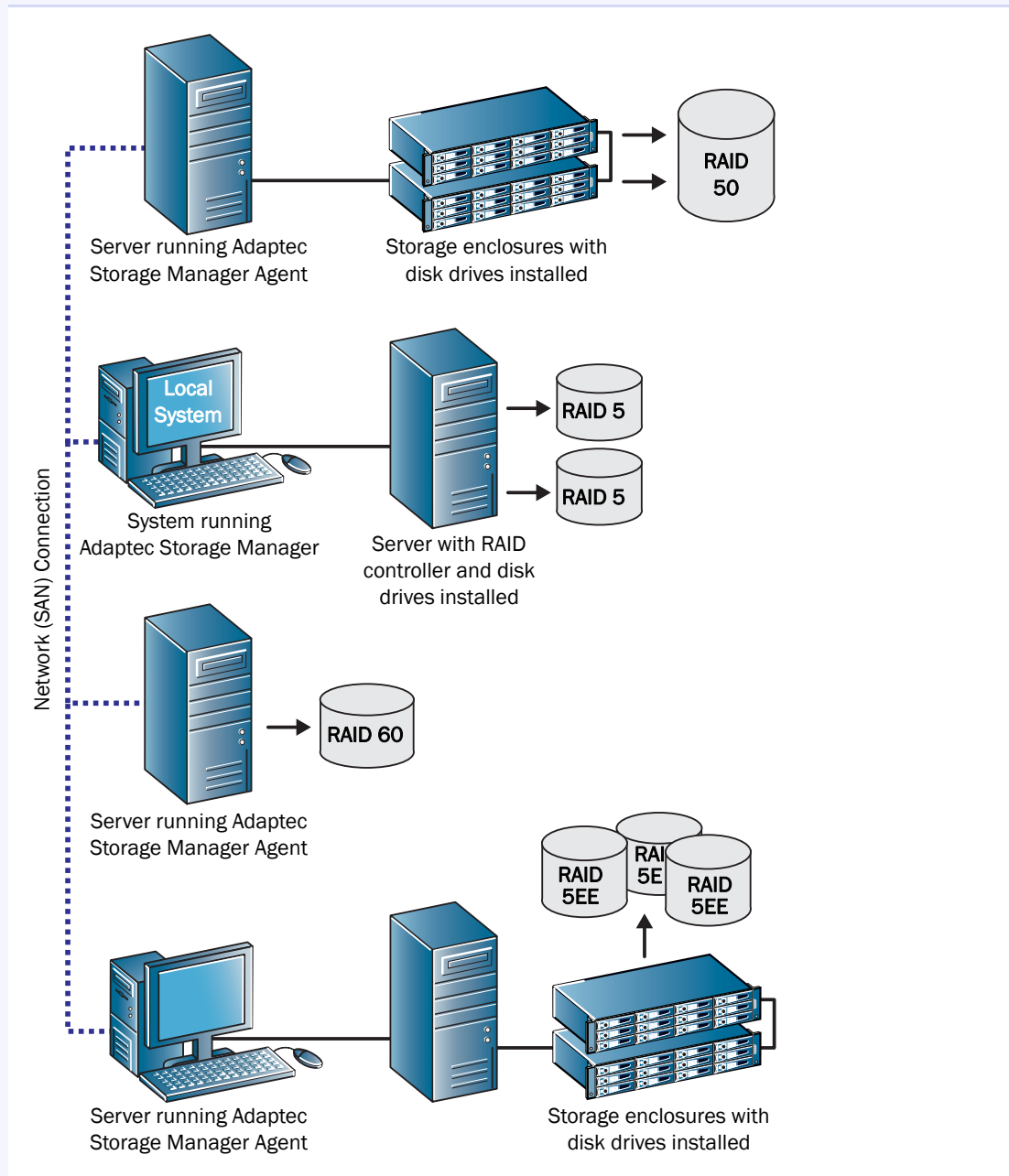

Note: You can add external RAID storage to your storage space by creating an IPSAN. For more information about using Adaptec Storage Manager to manage external RAID storage, refer to the Adaptec Web site at www.adaptec.com.

Adding Enhanced Features

As you grow your storage space, you can enhance data protection and improve performance by upgrading your Adaptec controller with extra features, then manage these enhanced features with Adaptec Storage Manager.

Currently, Adaptec offers the snapshot function as an upgrade feature which can be activated with a feature key (sold separately). A *snapshot* is a frozen image of a logical drive at a particular point in time. You can copy the data on one logical drive to another logical drive by creating a snapshot. For more information, see [page 87](#).

For the most up-to-date information about available upgrade features, refer to the Adaptec Web site at www.adaptec.com.

Locked features—features which are unavailable without a key—have a padlock icon beside them, as shown in the example at right. If you select a locked feature, you are reminded that a key is required to unlock it.

To purchase a feature key (also known as a software license key), contact your Adaptec Reseller or refer to the Adaptec Web site at www.adaptec.com.

To unlock enhanced features with a feature key, see [page 20](#).

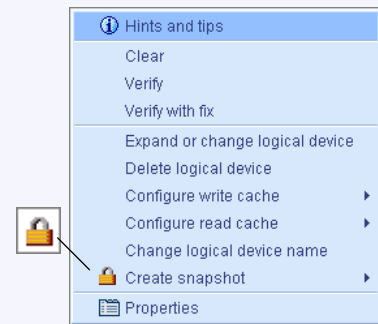

Unlocking the Enhanced Features

To unlock enhanced features with a feature key:

- 1 In the Enterprise View, right-click the controller you want, then click **Add feature key**.

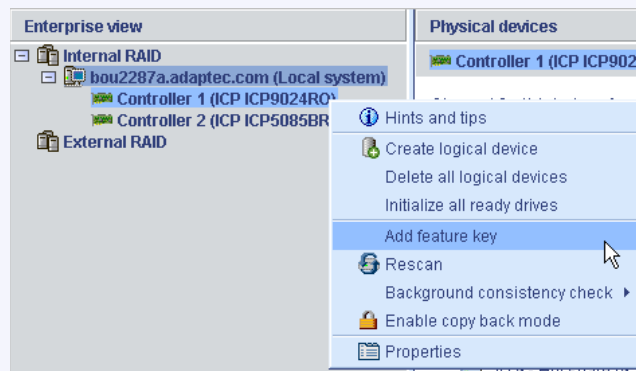

The Add Feature Key window opens.

- 2 Enter the feature key, then click **OK**.

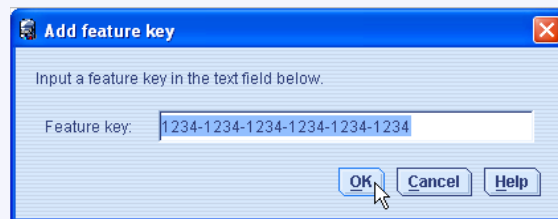

- 3 Click **OK** to confirm.

The enhanced features are unlocked and are now ready for use.

System Requirements

To install Adaptec Storage Manager and create an internal RAID storage space, each system in your storage space must meet these requirements:

- PC-compatible computer with Intel Pentium 1.2 GHz processor, or equivalent
 - At least 256 MB of RAM
 - 80 MB of free disk drive space
 - 256-color video mode
 - CD drive
 - One of these operating systems:
 - Microsoft® Windows® 32-bit:
 - Windows 2000 Server
 - Windows Advanced Server
 - Windows 2000 Professional
 - Windows Server 2003 Enterprise, Standard, Web Edition
 - Windows XP Professional
 - Windows for EM64T or AMD-64:
 - Windows Server 2003 Enterprise, Standard, Web Edition with current service pack
 - Windows XP Professional
 - Red Hat® Linux
 - SUSE Linux
- Note:** For the latest on Adaptec's support of Linux, or to download driver sources, visit www.adaptec.com.
- Novell® NetWare® 6.5 with current service pack
 - SCO®:
 - OpenServer® 6.0
 - UnixWare® 7.1.4
 - Solaris 10 with current update

Note: Adaptec Storage Manager can also be used before an operating system is installed. See [Running Adaptec Storage Manager from the CD on page 34](#) for more information.



Installing and Starting Adaptec Storage Manager

STEP 2

In this chapter...

Installing Adaptec Storage Manager.....	23
Starting Adaptec Storage Manager	28
Starting the Adaptec Storage Manager Agent Only.....	30
Using Adaptec Storage Manager with a Firewall	31
Understanding Permission Levels	32
Logging Out of Adaptec Storage Manager	34
Running Adaptec Storage Manager from the CD.....	34

Adaptec Storage Manager must be installed on every system that will be part of your storage space.

To use Adaptec Storage Manager to configure a RAID controller before you install your operating system, see *Running Adaptec Storage Manager from the CD* on page 34.

Installing Adaptec Storage Manager

To install and start Adaptec Storage Manager, follow the instructions for your operating system:

- To install on Windows, see the following section.
- To perform a silent Windows installation (*advanced users only*), see [page 24](#).
- To install on Linux, see [page 25](#).
- To install on NetWare, see [page 26](#).
- To install on UnixWare or OpenServer, see [page 26](#).
- To install on Solaris, see [page 27](#).

Note: *Advanced users*—To install Adaptec Storage Manager on VMWare, see [page 27](#).

Installing on Windows

This section describes how to install Adaptec Storage Manager on systems running Windows. See [System Requirements on page 21](#) for a list of supported operating systems.

Note: You need administrator or root privileges to install Adaptec Storage Manager. For details on verifying privileges, refer to your operating system documentation.

If a previous version of Adaptec Storage Manager is installed on your system, you must remove it before beginning this installation. To uninstall Adaptec Storage Manager, use the Add/Remove Programs option in your Windows Control Panel.

Note: *Advanced users only*—To perform a silent installation, follow the instructions on [page 24](#).

To install Adaptec Storage Manager:

- 1 Insert the Adaptec Storage Manager Installation CD.
The Installation wizard opens automatically. (If it doesn't open, browse to the CD in Windows Explorer, then click **Autorun**.)
- 2 Select **Internal RAID Controller Setup** or **Custom Setup** (*advanced users only*), then click **Next**.
- 3 Click **Next** to begin the installation, click **I accept...**, then click **Next**.
- 4 Follow the on-screen instructions to complete the installation.
- 5 Repeat these steps to install Adaptec Storage Manager on every Windows system that will be part of your storage space.
- 6 Continue with [Starting Adaptec Storage Manager on Windows on page 28](#).

Completing a Silent Windows Installation (Advanced)

A *silent installation* uses command line parameters to complete an installation without messages or user interaction.

To complete a silent installation:

- 1 Insert the Adaptec Storage Manager Installation CD into your CD drive.
- 2 Open a command prompt window and change to the CD directory.
- 3 Install Adaptec Storage Manager using this command line string:

```
setup.exe /s /v" /qn <properties>"
```

where <properties> is one or more of the options listed in the next table. Separate properties with spaces; separate feature names for the ADDLOCAL property with commas (see examples on [page 25](#)).

Property	Values
INSTALLDIR (Not required)	Specifies the installation path. If you are specifying the installation path, it must be set for a command line install, and must be enclosed in escaped quotation marks. For example: INSTALLDIR="C:\Program Files\Adaptec\Adaptec Storage Manager" Note: If you do not explicitly set the installation path, the default path is "C:\Program Files\Adaptec\Adaptec Storage Manager"
ADDLOCAL (Required)	Note: Use commas to separate multiple values. <ul style="list-style-type: none"> ● ALL—Installs all of the following features. If you specify ALL, do not also specify any of the following values. ● Manager—Installs Adaptec Storage Manager. If this feature is installed, your system will reboot if certain RAID cards that use the filter driver are installed. If necessary, you can use the REBOOT property to suppress this (see page 24). ● SNMPSupport—Installs SNMP support for Adaptec Storage Manager. If you specify the SNMPSupport value, the Manager value is also specified automatically. (See page 130 for more information about SNMP support.) ● ASMReadme—Installs the Readme file its Start menu shortcut. ● CLITools—Installs Command Line Interface tools.
REBOOT (Not Required)	<ul style="list-style-type: none"> ● Force—Forces a reboot at the end of the installation. ● Suppress—Suppresses a reboot unless files were in use and could not be overwritten during installation. ● ReallySuppress—Suppresses all reboots at the end of the installation. NOTE: A reboot is only forced by the Adaptec installer if you have installed Manager or DSM, or if any files can't be overwritten.

Note: Synchronous Installation—To install Adaptec Storage Manager so that the setup.exe file does not close until the installation is complete, add the /w parameter to setup.exe and run the application with the start /WAIT command as shown in this example:

```
start /WAIT setup.exe /w /s /v" /qn <OPTIONS>"
```

You might want to do this for a batch file installation so that the setup will not return until the installation is finished.

- 4 After a minute or two, the silent installation should be complete and the Adaptec Storage Manager icon should be accessible.

Example Command Line Installations

- To install the basic options, which include the Manager, Readme, and SNMP Support:

```
setup.exe /s /v" /qn ADDLOCAL=Manager,ASMReadme,SNMPSupport"
```
- To install just the Manager and suppress a reboot at the end of installation:

```
setup.exe /s /v" /qn ADDLOCAL=Manager REBOOT=ReallySuppress"
```
- To install all features silently, on a machine named COMP1234, and force a reboot:

```
setup.exe /s /v" /qn ADDLOCAL=Manager, ASMReadme, SNMPSupport, CLITools  
REBOOT=Force"
```
- To install only the CLI Tools and suppress a reboot:

```
setup.exe /s /v" /qn ADDLOCAL=CLITools REBOOT=ReallySuppress"
```
- To install the Manager to a different installation path:

```
setup.exe /s /v" /qn ADDLOCAL=Manager INSTALLDIR="C:\Adaptec Storage  
Manager\" "
```
- To install the Manager and have setup wait until the installation finishes before it closes:

```
start /WAIT setup.exe /w /s /v" /qn ADDLOCAL=Manager REBOOT=ReallySuppress"
```

Installing on Linux

This section describes how to install Adaptec Storage Manager on systems running Linux. See [System Requirements on page 21](#) for a list of supported operating systems.

Adaptec Storage Manager includes the Java Runtime Environment (JRE).

Note: If a previous version of Adaptec Storage Manager is installed on your system, you must remove it before beginning this installation. Any customization files you created with the previous version are saved and used in the upgrade. To remove Adaptec Storage Manager, type the `rpm --erase StorMan` command.

To install Adaptec Storage Manager:

- 1 Insert the Adaptec Storage Manager Installation CD.
- 2 Mount the Adaptec Storage Manager Installation CD:
 For Red Hat `mount /dev/cdrom /mnt/cdrom`
 For SUSE `mount /dev/cdrom /media/cdrom`
- 3 Change to the cdrom directory:
 For Red Hat `cd /mnt/cdrom/linux/manager`
 For SUSE `cd /media/cdrom/linux/manager`
- 4 Extract the RPM package and install it:

```
rpm --install ./StorMan*.rpm
```
- 5 Unmount the Adaptec Storage Manager Installation CD:
 For Red Hat `umount /mnt/cdrom`
 For SUSE `umount /media/cdrom`

- 6 Repeat these steps to install Adaptec Storage Manager on every Linux system that will be part of your storage space.
- 7 Continue with [Starting Adaptec Storage Manager on Linux on page 29](#).

Installing on NetWare

This section describes how to install Adaptec Storage Manager on systems running NetWare. See [System Requirements on page 21](#) for a list of supported operating systems.

You need the latest Support Pack for your operating system so you can run the supported Java Virtual Machine (JVM). You need JVM version 1.3 or later. To check your JVM version, load JVM, type `JAVA -VERSION`.

Note: For the latest updates from Novell, visit www.novell.com.

To install Adaptec Storage Manager:

- 1 Insert the Adaptec Storage Manager Installation CD.
- 2 From the command prompt, type `load cdrom` and press **Enter**.
- 3 From the command prompt, type:

```
xx_yy_zz:\netware\manager\install
```

where `xx` is the product CD, `yy` is the version number, and `zz` is the release number (for example, `adptcd_v2_01`).
The installation program starts.
- 4 Follow the on-screen instructions to complete the installation.
- 5 Repeat these steps to install Adaptec Storage Manager on every NetWare system that will be part of your storage space.
- 6 Continue with [Starting Adaptec Storage Manager on NetWare on page 29](#).

Installing on UnixWare or OpenServer

Note: If a previous version of Adaptec Storage Manager is installed on your system, you must remove it before beginning this installation. Any customization files you created with the previous version are saved and used in the upgrade. To remove Adaptec Storage Manager, type the `pkgrm RaidMan` command.

To install Adaptec Storage Manager:

- 1 Insert the Adaptec Storage Manager Installation CD.
- 2 Mount the Adaptec Storage Manager Installation CD:

```
mount -r -F cdfs /dev/cdrom/cdromdevicefile /mnt
```

where `cdromdevicefile` is the device file name (for example, `c0b0t010` for a CD-ROM block device). To find the device file name, look in the `/dev/cdrom` directory.
- 3 Install Adaptec Storage Manager:
For UnixWare `pkgadd -d /mnt/unixware/manager/RaidMan.ds`
For OpenServer `pkgadd -d /mnt/openserv6/manager/RaidMan.ds`

- 4 Follow the on-screen instructions to complete the installation.
- 5 Unmount the Adaptec Storage Manager Installation CD:

```
umount /mnt
```

Installing on Solaris

Note: If a previous version of Adaptec Storage Manager is installed on your system, you must remove it before beginning this installation. Any customization files you created with the previous version are saved and used in the upgrade. To remove Adaptec Storage Manager, type the `pkgrm RaidMan` command.

To install Adaptec Storage Manager:

- 1 Insert the Adaptec Storage Manager Installation CD.

The CD mounts automatically. (If it doesn't, manually mount the CD using a command similar to the one shown below. Refer to your operating system documentation for detailed instructions.)

```
mount -F hsfs -o ro/dev/dsk/c1t0d0s2/mnt
```

- 2 Install Adaptec Storage Manager:

```
pkgadd -d/<mount point>/solaris/manager/StorMan.ds
```

- 3 Follow the on-screen instructions to complete the installation.
- 4 Eject or unmount the Adaptec Storage Manager Installation CD. Refer to your operating system documentation for detailed instructions.

Using Adaptec Storage Manager on VMWare

To install Adaptec Storage Manager:

- 1 Mount the Adaptec Storage Manager Installation CD:

```
mount -r /dev/cdrom /mnt/cdrom
```

- 2 Change to the cdrom directory:

For Red Hat `cd /mnt/cdrom/linux/manager`

For SUSE `cd /media/cdrom/linux/manager`

- 3 Extract the Linux Adaptec Storage Manager RPM package and install it:

```
rpm --install ./StorMan*.rpm
```

Note: Ignore the note that says "Application can be started by typing `/usr/StorMan/StorMan.sh`". The console has no graphical capability.

- 4 Use the command line utility (ARRCONF) included with your RAID controller to configure and manage your disk drives. For more information, refer to the *Command Line Interface User's Guide* on the Adaptec Storage Manager Installation CD.
- 5 To use Adaptec Storage Manager to connect remotely from another system, you must open a range of ports in the built-in firewall using this command:

```
esxcfg-firewall -o 34571:34581,tcp,in,"StorMan"
```

For more information, see [Logging In to Remote Systems](#) on page 58.

Starting Adaptec Storage Manager

Note: You need root privileges to run Adaptec Storage Manager.

To start Adaptec Storage Manager, follow the instructions for your operating system. To start the Adaptec Storage Manager Agent only, see [page 30](#).

- To start on Windows, see the following section.
- To start on Linux, see [page 29](#).
- To start on NetWare, see [page 29](#).
- To start on UnixWare or OpenServer, see [page 29](#).
- To start on Solaris, see [page 29](#).

Starting Adaptec Storage Manager on Windows

On systems running Windows, you can run Adaptec Storage Manager as a *stand-alone application* (like a regular software application), or in a browser window (such as Microsoft Internet Explorer).

Note: Normally, you only need to run Adaptec Storage Manager in a browser window if you're working on a system that *isn't* part of your storage space (does not have a controller installed). If the system you're working on is part of your storage space, run Adaptec Storage Manager as a standalone application.

- 1 Click **Start > Programs > Adaptec Storage Manager**.

The Log In dialog box appears.

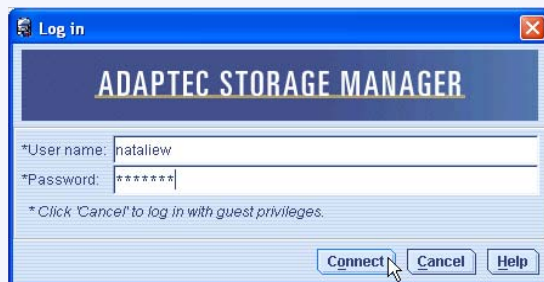

- 2 Enter the user name and password that you use to log on to your system, then click **Connect**.

Note: Each user name has a permission level associated with it. See [Understanding Permission Levels on page 32](#) for more information.

Starting Adaptec Storage Manager on Linux

- 1 Type the following command to change to the Adaptec Storage Manager installation directory:

```
cd /usr/StorMan
```

- 2 Type the following command and press Enter:

```
sh StorMan.sh
```

- 3 When the Log In dialog box appears (see [page 28](#)), enter the user name and password that you use to log on to your system, then click **Connect**.

Note: Each user name has a permission level associated with it. See [Understanding Permission Levels on page 32](#) for more information.

Starting Adaptec Storage Manager on NetWare

To start Adaptec Storage Manager on the NetWare operating system, type the `LOAD RAIDMAN` command.

Starting Adaptec Storage Manager on UnixWare or OpenServer

To start Adaptec Storage Manager:

- 1 Change to the directory where Adaptec Storage Manager is installed:

```
cd /opt/RaidMan
```

- 2 Launch the Adaptec Storage Manager script:

```
sh RaidMan.sh
```

Starting Adaptec Storage Manager on Solaris

To start Adaptec Storage Manager:

- 1 Change to the directory where Adaptec Storage Manager is installed:

```
cd /usr/StorMan
```

- 2 Launch the Adaptec Storage Manager script:

```
sh StorMan.sh
```

Starting the Adaptec Storage Manager Agent Only

Note: For more information, see [About the Adaptec Storage Manager Agent on page 17](#).

To start the Adaptec Storage Manager Agent only, follow the instructions for your operating system:

- To start on Windows, see the following section.
- To start on Linux, see [page 30](#).
- To start on NetWare, see [page 31](#).
- To start on UnixWare or OpenServer, see [page 31](#).
- To start on Solaris, see [page 31](#).

Starting the Agent on Windows

On systems running Windows, the Adaptec Storage Manager Agent starts automatically when the system is powered on.

To verify that the Agent is running:

- 1 Open the Windows **Control Panel**.
- 2 Double-click **Administrative Tools**, then double-click **Services**.
- 3 In the list of services, check that the Adaptec Storage Manager Agent is installed and running. If it's not, you can choose to restart it.
- 4 Manage and monitor the system by logging into it as a remote system (see [page 58](#)).

The Adaptec Storage Manager Agent's default settings are suitable for most storage spaces. To customize the settings for your specific requirements, see [page 62](#).

Starting the Agent on Linux

On systems running Linux, the Adaptec Storage Manager Agent starts automatically when the system is powered on.

To verify that the Agent is running:

- 1 Open a shell window.
- 2 Enter this command: `ps -ef | grep StorAgnt.sh`

If the Agent is running, it's listed as `sh StorAgnt.sh`.

- 3 Manage and monitor the system by logging into it as a remote system (see [page 58](#)).

The Adaptec Storage Manager Agent's default settings are suitable for most storage spaces. To customize the settings for your specific requirements, see [page 62](#).

Starting the Agent on NetWare

To start the Agent:

- 1 From the NetWare console, type: `LOAD RaidAgnt`
- 2 Press **Enter**.
- 3 Manage and monitor the system by logging into it as a remote system (see [page 58](#)).

The Adaptec Storage Manager Agent's default settings are suitable for most storage spaces. To customize the settings for your specific requirements, see [page 62](#).

Starting the Agent on UnixWare or OpenServer

To start the Agent:

- 1 Type: `sh /opt/RaidMan/RaidAgnt.sh`

When the Agent has started, a copyright message appears.

- 2 Manage and monitor the system by logging into it as a remote system (see [page 58](#)).

The Adaptec Storage Manager Agent's default settings are suitable for most storage spaces. To customize the settings for your specific requirements, see [page 62](#).

Note: To have the Agent run automatically at system start-up, add this line to the `/etc/inittab` and `/etc/conf/init.d/kernel` files: `nfra:12346:once:sh /opt/RaidMan/RaidAgnt.sh`

Starting the Agent on Solaris

To start the Agent:

- 1 Enter this command:

```
svcadm enable ADPTstor_agent
```

- 2 Manage and monitor the system by logging into it as a remote system (see [page 58](#)).

The Adaptec Storage Manager Agent's default settings are suitable for most storage spaces. To customize the settings for your specific requirements, see [page 62](#).

Using Adaptec Storage Manager with a Firewall

If your network includes a firewall, you must unblock the ports listed in this section.

Unblock this port to ensure that Adaptec Storage Manager operates properly:

- 8003 (TCP)

Unblock these ports to allow Adaptec Storage Manager remote access to systems on your network:

- 34570 to 34580 (TCP)
 - 34570 (UDP)
 - 34577 to 34580 (UDP)
-

Understanding Permission Levels

When you log in to Adaptec Storage Manager, your permission level is identical to your operating system permission level. For example, if you have Administrator permissions on your operating system, you also have Administrator permissions in Adaptec Storage Manager.

Note: *NetWare users only*—See [Configuring NetWare User Authentication on page 33](#).

This section describes the three different permission levels.

Administrator Level

Logging in as an Administrator allows you full access to manage and modify the controllers, disk drives, and logical drives that are part of your storage space.

To log in as an Administrator:

- **Windows**—Enter a valid user name and password for the Administrator or Administrative User on the system. (The Administrative User is any member of the local Administrators group, which can, in a Domain configuration, include Domain Administrators.)
- **Linux**—Enter `root` for the user name and enter the root password.
- **Netware**—See [page 33](#).
- **UnixWare or OpenServer**—Enter `root` for the user name and enter the root password.
- **Solaris**—Enter `root` for the user name and enter the root password.

User Level

Logging in as a User partially restricts your access to the storage space, as described in this table.

Users can...	User's can't...
Rescan controllers	Create logical drives
Save activity logs	Modify logical drives
Verify disk drives (with and without fix)	Delete logical drives
Verify logical drives (with and without fix)	Delete hot spares
Identify disk drives and enclosures	Perform data migrations
Rebuild disk drives	
Create hot spares	
Access the same information as Guests (see the following section)	

To log in as a User, use your normal network user name and password.

Guest Level

Logging in as a Guest restricts your access to the storage space to “view-only”.

You can see all local and remote systems and view their properties windows, view event logs, save configuration files and support archives, and browse the online Help.

You cannot make any changes to the storage space.

To log in as Guest, click **Cancel** on the Login window.

Configuring NetWare User Authentication

This section describes two ways to configure NetWare user authentication.

Out-of-box Authentication

- **Administrative Access**—Granted exclusively to the Admin user account, which must be defined within the NetWare Bindery context of the server running the Adaptec Storage Manager Agent.
- **User Access**—Granted to all Bindery and NetWare Directory Services (NDS) user accounts. For NDS users, the user account must reside within the same tree as the server running the Adaptec Storage Manager Agent.

When logging into Adaptec Storage Manager, NDS users must provide the fully distinguished account name.

NDS Authentication

NDS authentication is based on NDS group membership.

To set up NDS group membership:

- 1 Create and populate an NDS group for storage administration.

Note: The group must reside within the same NDS tree as the server running the Adaptec Storage Manager Agent.

- 2 Install Adaptec Storage Manager (see [page 26](#)).
- 3 Add this entry to the SYS:\RaidMan\RaidAgnt.pps file:

```
agent.group.NetWareStorageAdmin:<fully distinguished group name>
```

For example:

```
agent.group.NetWareStorageAdmin: .CN\=StorageAdmins.O\=Acme
```

- 4 Restart the server.

Limited user access is granted to all NDS user accounts.

Logging Out of Adaptec Storage Manager

To log out of Adaptec Storage Manager:

- 1 In the Enterprise View, click on the local system.
- 2 In the menu bar, select **Actions**, then click **Log out**.

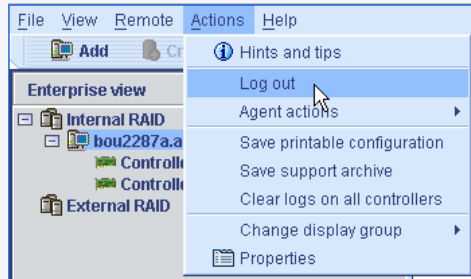

You are logged out of Adaptec Storage Manager.

Logging Back In

To log in to Adaptec Storage Manager:

- 1 In the Enterprise View, click on the local system.
- 2 In the menu bar, select **Actions**, then click **Log in**.
- 3 Enter your user name and password, then click **Connect**. (See [Understanding Permission Levels](#) on page 32 for more information.)

Running Adaptec Storage Manager from the CD

This section describes how to run Adaptec Storage Manager from the Adaptec RAID installation CD included in the kit, instead of as an installed application. When you run Adaptec Storage Manager from the CD, you are using *bootable-CD mode*.

When to Choose Bootable-CD Mode

Use Adaptec Storage Manager in bootable-CD mode if you want to install your operating system on a disk drive or logical drive associated with your controller. Bootable-CD mode lets you configure the controller before you install your operating system.

After you have configured the controller and installed the operating system, install and run Adaptec Storage Manager as an installed software application, as described earlier in this chapter.

Bootable-CD Mode Limitations

Running Adaptec Storage Manager from the CD is not an alternative to running it as an installed software application. Most of the features and functions described in this *User's Guide* are not available when you are running Adaptec Storage Manager from the CD. Bootable-CD mode is only for configuring your controller before you install an operating system.

Getting Started in Bootable-CD Mode

This is a checklist of tasks to complete when you're building your storage space with Adaptec Storage Manager in bootable-CD mode.

- ✓ Install your Adaptec RAID controller.
- ✓ Run Adaptec Storage Manager (see the following section).
- ✓ Build your storage space (see [page 45](#)).

For an introduction to the Adaptec Storage Manager window and its features, see [page 37](#).

- ✓ Install your operating system (and controller device drivers, if appropriate).
- ✓ Install Adaptec Storage Manager as a software application (see [page 23](#)).
- ✓ Continue to build, customize, and manage your storage space as described in the rest of this *User's Guide*.

Running Adaptec Storage Manager from the CD

Note: Before you begin, ensure that your system is set up to boot from a CD. Check the system BIOS to see if the CD drive is listed first in the boot order. For more information, refer to your system's documentation.

To run Adaptec Storage Manager in bootable-CD mode:

- 1 Insert the RAID installation CD into your CD drive, then restart your system.
- 2 When prompted, select the language you want, then press **Enter**.
- 3 Review the license information, then press **Enter**.

The main CD menu opens.

- 4 Click **Launch Configuration Utility**.

Adaptec Storage Manager opens.

- 5 Click **Create**.

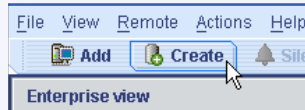

The Configuration wizard opens.

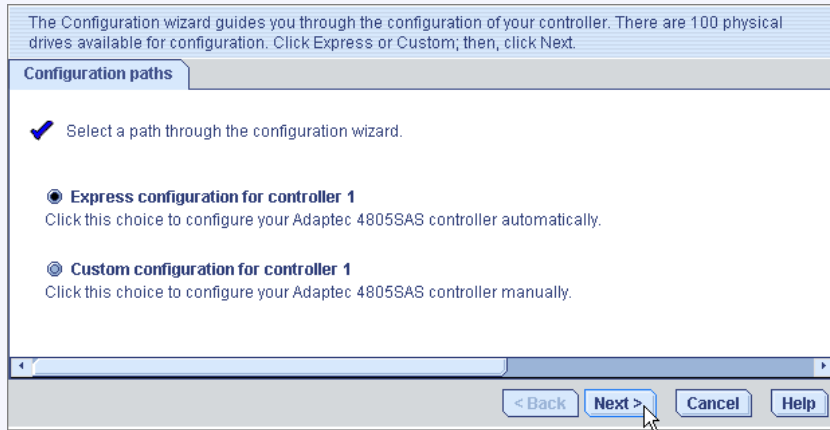

- 6 Continue with *Building Your Storage Space* on page 45.



Exploring Adaptec Storage Manager

STEP 3

In this chapter...

Navigating the Main Window.....	38
Using the Enterprise View.....	39
Using the Physical Devices View	40
Using the Logical Devices View	41
Revealing More Disk Drive Information	42
Checking System Status	43
Working in Adaptec Storage Manager	44
Getting Help	44

Before you build your storage space, familiarize yourself with the main features of Adaptec Storage Manager and learn to navigate to the information you need.

Navigating the Main Window

The main window of Adaptec Storage Manager has three main panels, or *views*, in addition to the other features shown in this figure.

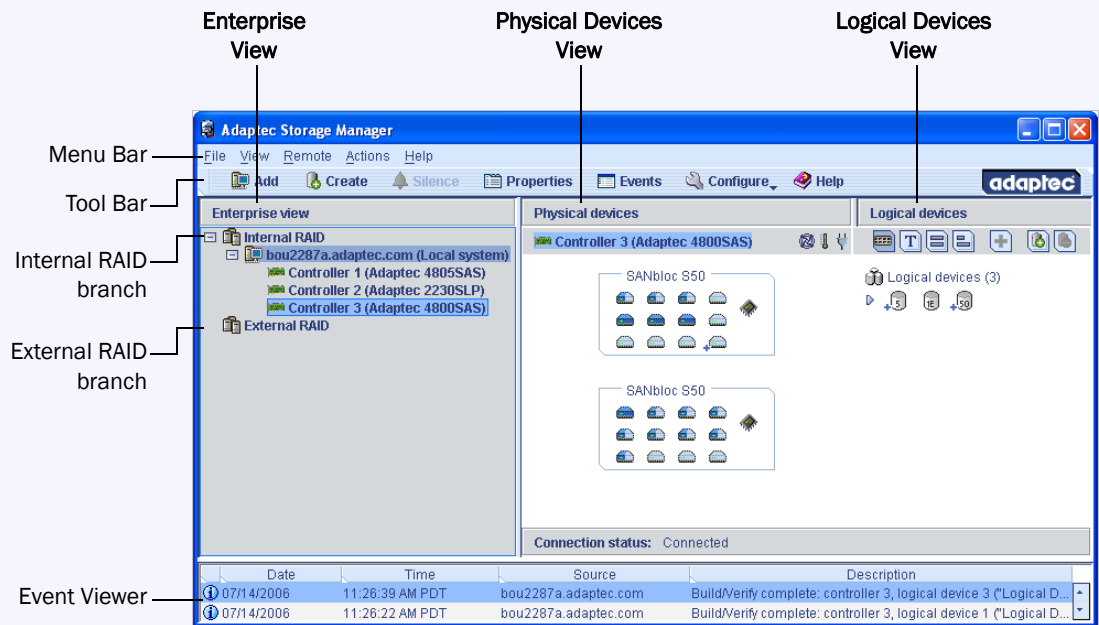

Resize the panels and scroll horizontally or vertically as required, to view more or less information.

For more information about specific areas of the main window, see these sections:

- [Using the Enterprise View on page 39.](#)
- [Using the Physical Devices View on page 40.](#)
- [Using the Logical Devices View on page 41.](#)

Using the Enterprise View

The Enterprise View is an expandable tree with two main branches—the Internal RAID branch, and the External RAID branch. The External RAID branch is not covered in this *User's Guide*—refer to the Adaptec Web site at www.adaptec.com for more information.

Under Internal RAID, the Enterprise View lists the local system (the system you're working on) and any other systems that you're managing using Adaptec Storage Manager.

Expand a system in the Enterprise View to see its controllers. (See [Logging In to Remote Systems](#) on page 58 for more information about local and remote systems.)

Note: See [Creating Display Groups](#) on page 60 to learn how to group related systems together in the Enterprise View.

When you select a component in the Enterprise View, the disk drives and logical drives (“devices”) associated with it appear in the Physical and Logical Devices Views, as shown in these figures.

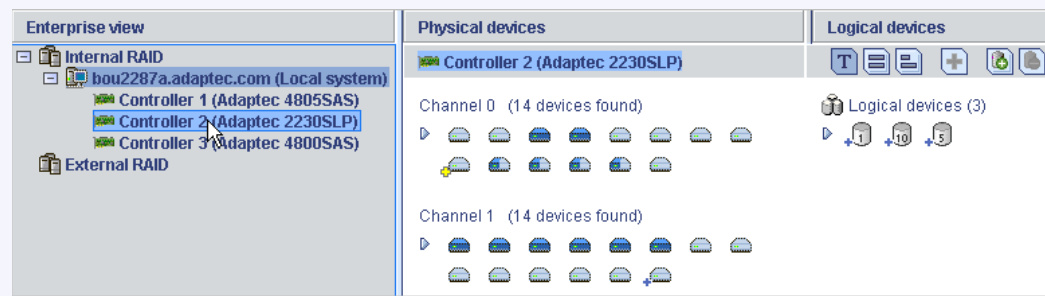

By selecting a controller in the Enterprise View...

...the disk drives (shown above) or enclosures and disk drives (shown below) connected to it and the logical drives created with those disk drives appear in the Physical and Logical Devices Views.



You can perform most tasks by selecting a controller in the Enterprise View and working with its associated devices in the Physical and Logical Devices Views.

Using the Physical Devices View

When you select a controller in the Enterprise View, information about the physical disk drives and enclosures connected to that controller appear in the Physical Devices View.

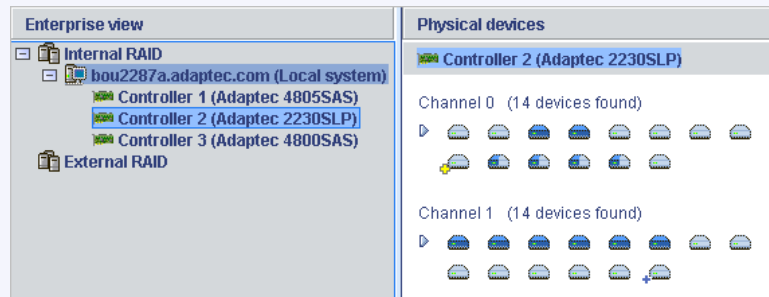

Controller 2 is connected to... 28 disk drives.

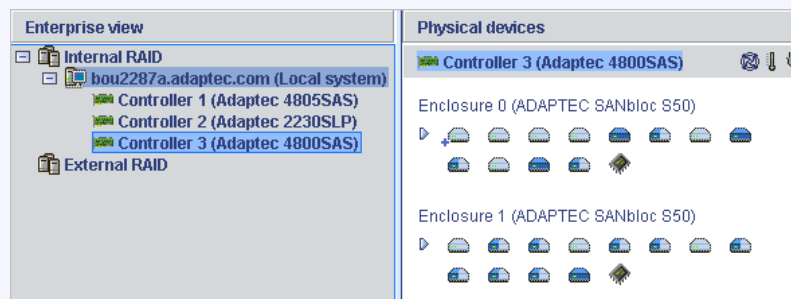

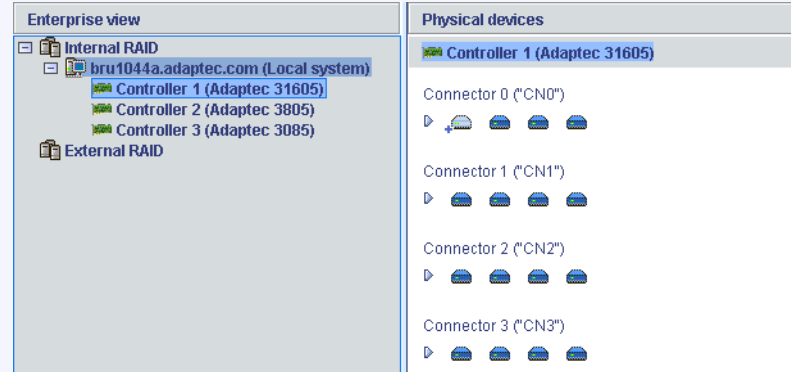

Controller 1 is connected to... 2 enclosures (and 24 disk drives).





Controller 1 is connected to... 16 disk drives.

Disk drives designated as hot spares have plus signs (+) beside them:

- A blue plus sign (shown at right) means that the spare is protecting at least one logical drive. 
- A hot spare with a yellow plus sign (shown at right) may not be large enough to protect the logical drive it's assigned to, or may not be assigned to a logical drive. 

See [Working with Hot Spares on page 81](#) for more information.

Hold your cursor over any disk drive to see its status, port/connector/ID number, and maximum speed. You can also click the arrow, shown at right, to see this same information for all the disk drives at the same time. To reveal further information, use the View buttons to change how the disk drives are displayed, as described in [Revealing More Disk Drive Information on page 42](#). 

A disk drive shaded in light blue is not part of any logical drive. A disk drive shaded half light/half dark blue (as shown at right) has some space allocated to a logical drive, and some space available. 

To view the logical drives associated with a particular disk drive, see [Using the Logical Devices View on page 41](#).

If your storage space includes an enclosure, its enclosure management device is represented by the icon shown at right. 

Using the Logical Devices View

When you select a controller in the Enterprise View, information about the logical drives and arrays associated with that controller appear in the Logical Devices View. (A *logical drive* is a group of physical disk drives that your operating system recognizes as a single drive. For more information, see [Understanding Logical Drives on page 67](#).)

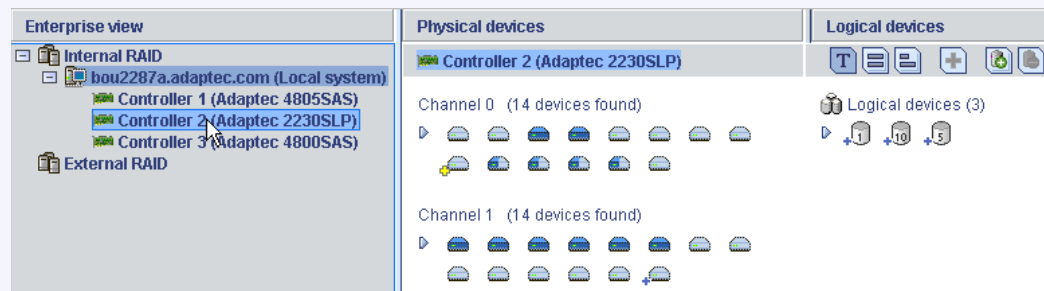

Controller 2 is connected to... ...28 disk drives... ...from which 3 logical drives have been created.

The RAID level of a logical drive is indicated by the number inside the logical drive's icon. For instance, the logical drive shown at right has RAID 1. Logical drives protected by hot spares have plus signs (+) beside them, as shown at right. 

Hold your cursor over any logical drive to see its name, status, and size. You can also click the arrow, shown at right, to view this same information for all the logical drives at once. 

Click on a logical drive to highlight the disk drives that comprise it in the Physical Devices View.

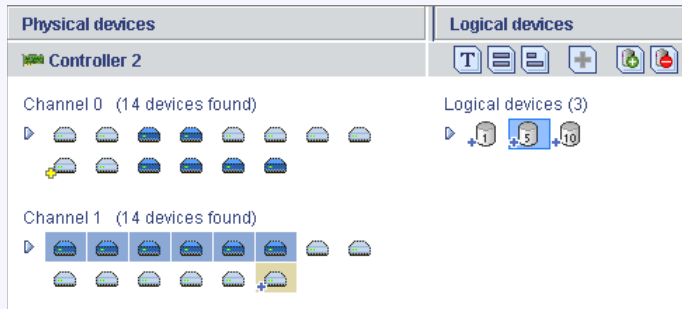

Six disk drives (plus one hot spare) comprise the selected RAID 5 logical drive.

You can also click on any disk drive to see which (if any) logical drive it belongs to. A disk drive shaded in light blue is not part of any logical drive.

Revealing More Disk Drive Information

You can reveal more information about your disk drives by using the View buttons to change how they are displayed.

By default, disk drives are displayed in *unexpanded* Text Description View, or

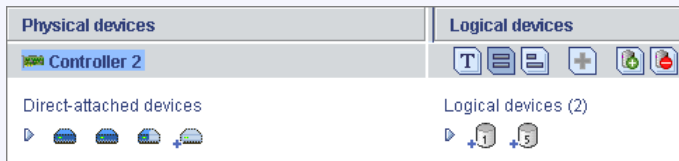

if you are managing disk drives in an enclosure, in Enclosure View.

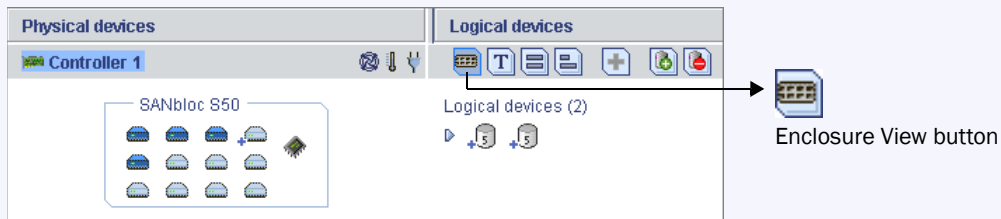

Note: Not all enclosures are supported by Adaptec Storage Manager. Unsupported enclosures do not appear in Enclosure View.

Click the expand arrow to see basic disk drive information.

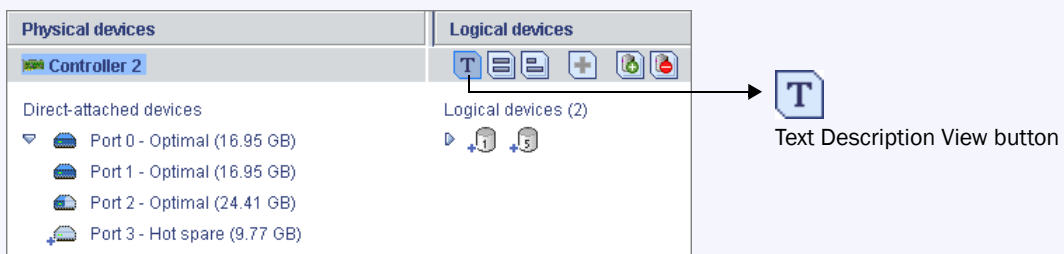

Click the **Full Size Capacity View** button to see the size capacities of your disk drives. Disk drives or segments of disk drives that are included in logical drives are shaded brown.

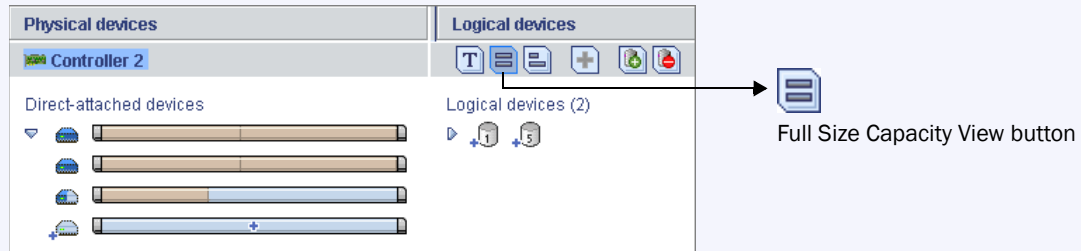

Click the **Relative Size Capacity View** button to see the size capacities of your disk drives relative to each other. A full length bar is displayed for the largest disk drive. Proportionally shorter bars are displayed for other disk drives.

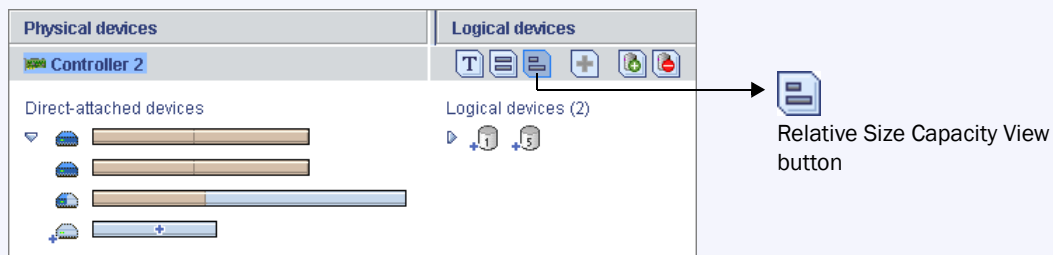



Checking System Status

Adaptec Storage Manager includes an Event Viewer for at-a-glance system and event status information. The Event Viewer provides status information and messages about activity (or *events*) occurring in your storage space. Double-click any event to see more information in an easier-to-read format.

Date	Time	Source	Description
04/01/2005	03:42:53 PM PST	bou2287c	Synchronize complete: controller 3, logical drive 1 ("Drive 1").
04/01/2005	03:41:51 PM PST	bou2287c	Added logical drive: controller 3, logical drive 1 ("Drive 1"). Size = 9.7 G...
04/01/2005	03:41:51 PM PST	bou2287c	Synchronizing: controller 3, logical drive 1 ("Drive 1").
04/01/2005	03:41:50 PM PST	bou2287c	Successfully applied the new configuration: controller 3.

Warning- and Error-level icons, shown at right, appear next to components (such as systems and logical drives) affected by a failure or error, creating a trail, or *rapid fault isolation*, that helps you identify the source of a problem when it occurs. See [Identifying a Failed or Failing Component on page 134](#) for more information.

Enclosure
Warning 

Disk Drive
Error 

If your storage space includes a controller with a temperature sensor, or an enclosure with an enclosure management device, such as a SCSI Accessed Fault-Tolerant Enclosure (SAF-TE) processor, temperature, fan, and power module status is displayed by status icons in the Physical Device view, as shown in the next figure. These status icons change color to indicate status (see [page 106](#)).

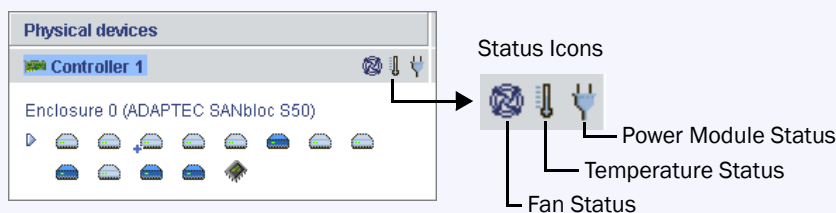

For more information, see [Monitoring Your Storage Space on page 90](#).

Note: By default, all Warning- and Error-level events activate an audible alarm. See [Silencing and Testing the Audible Alarm on page 107](#) for more information.

Working in Adaptec Storage Manager

Adaptec Storage Manager provides multiple ways to work with its menus and windows.

Most menu options are available by:

- Selecting items from the menu bar.
- Clicking buttons on the tool bar.
- Right-clicking on components in the main window. (Only tasks and windows associated with a specific component are available on right-click menus.)

For simplicity, the tasks in this *User's Guide* are explained mainly using menu bar options.

About the Actions Menu

Most of the main tasks in Adaptec Storage Manager are part of the Actions menu on the menu bar. Options on the Actions menu vary, depending on which type of component is selected in the main window. For instance, managed systems, disk drives, and hot spares each have specialized Actions menus.

For an overview of all Actions menu options, see [What options are on the Actions menu? on page 150](#).

Getting Help

Adaptec Storage Manager online Help includes conceptual information, glossary definitions, and descriptions of on-screen menus and items, in addition to step-by-step instructions for completing tasks.

To open the online Help, click the **Help** button (shown at right). Alternatively, press the F1 key, or in the menu bar select **Help**, then click **Search** or **Contents**.



Press the **Help** button in a dialog box or wizard for help with that specific dialog box, window, or procedure.

Additionally, you can find the most commonly asked-about information in [Quick Answers to Common Questions... on page 146](#) of this *User's Guide*. For help identifying features of Adaptec Storage Manager, see [Buttons and Icons At-a-Glance on page 153](#).



Building Your Storage Space

STEP 4

In this chapter...

Selecting a Configuration Method	46
Express Configuration: Building the Easy Way	46
Custom Configuration (Advanced)	49
Building a RAID Volume	54
RAID Controller Support	55
Managing Your Storage Space	56

Once you have logged in to Adaptec Storage Manager, you can begin to build your storage space by creating logical drives. (For more information, see [Understanding Logical Drives on page 67.](#))

Note: You must be logged in as an Administrator to complete the tasks described in this chapter.

Selecting a Configuration Method

Adaptec Storage Manager has a wizard to help you build (or *configure*) logical drives, and offers two configuration methods to choose from, depending on your needs:

- **Express configuration (basic)**—Automatically creates logical drives by grouping together same-sized physical drives, and assigns RAID levels based on the number of physical disk drives in the logical drive.

Use the express method when you want to use all available disk drives in the most efficient manner. For instructions, see the next section.

- **Custom configuration (advanced)**—Helps you group disk drives, set RAID levels, determine logical drive size, and configure advanced settings manually.

Use the custom method when you want to create specific logical drives with any or all available disk drives. For instructions, see [page 49](#).

Note: Adaptec recommends that you *not* combine SAS and SATA disk drives within the same logical drive. Adaptec Storage Manager generates a warning if you try to create a logical drive using a combination of SAS and SATA disk drives.

Express Configuration: Building the Easy Way

When you use express configuration, Adaptec Storage Manager automatically creates logical drives by grouping together same-sized physical disk drives, and assigns RAID levels based on the number of physical disk drives in a logical drive:

- A logical drive with three or more physical disk drives is assigned RAID 5.
- A logical drive with two physical disk drives is assigned RAID 1.
- A logical drive with only a single physical disk drive becomes a simple volume, which does not offer redundancy.

Note: To create a logical drive with any other RAID level, you must use the custom method, as described on [page 49](#). See [Selecting the Best RAID Level on page 157](#) for more information about RAID levels.

By default, logical drive size is set by Adaptec Storage Manager and automatically maximizes the capacity of the disk drives. However, you can choose to specify a size for a logical drive, if required.

To build your storage space with the express method:

- 1 In the Enterprise View, select the controller you want.
- 2 On the toolbar, click **Create**.

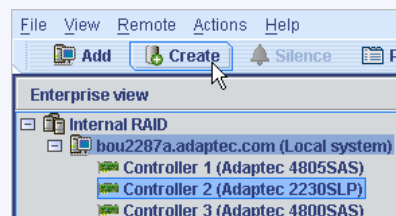

- 3 When the wizard opens, select **Express configuration...**, then click **Next**.

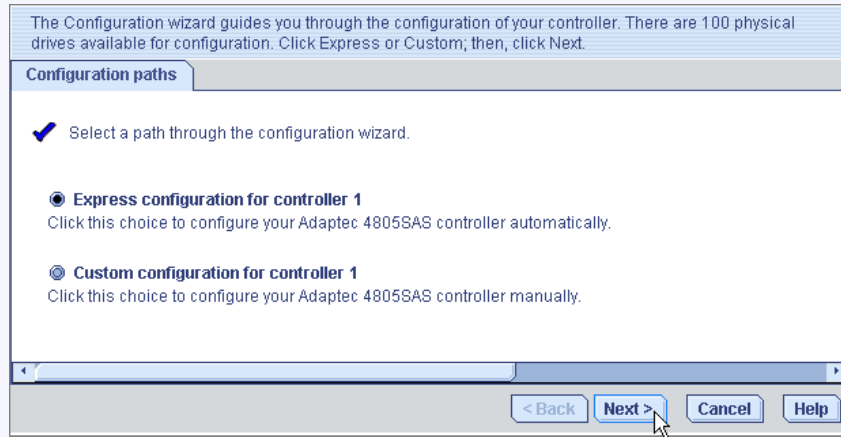

- 4 Review the information that is displayed.

Note: Adaptec recommends that you *not* combine SAS and SATA disk drives within the same logical drive. Adaptec Storage Manager generates a warning if you try to create a logical drive using a combination of SAS and SATA disk drives.

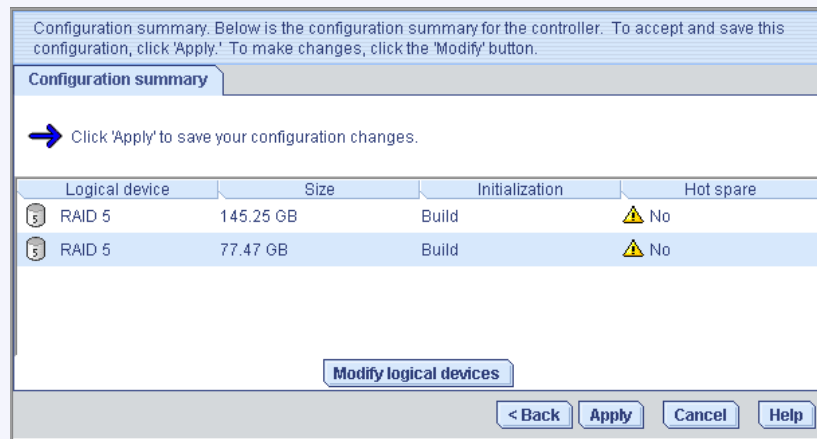

To exclude specific disk drives, specify a size for the logical drives, or to make other changes to the configuration, click **Modify logical devices**. See [Step 6 on page 50](#) for more information.

Note: Some operating systems have size limitations for logical drives. Before you save the configuration, verify that the size of the logical drive is appropriate for your operating system.

- 5 Click **Apply**, then click **Yes**.



Adaptec Storage Manager builds the logical drive(s), indicated by a magnifying glass moving across the new logical drive icon in the Logical Devices View. The configuration is saved on the Adaptec controller and on the physical drives.

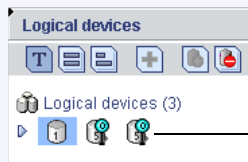

A magnifying glass means that a logical drive is being built. It disappears once the logical drive has been created.

Note: To stop the creation of a new logical drive, right-click on the magnifying glass icon (shown in the figure above), then select **Stop current task**. You can also change the priority of the build task to High, Medium, or Low by selecting **Change background task priority** from the same right-click menu.

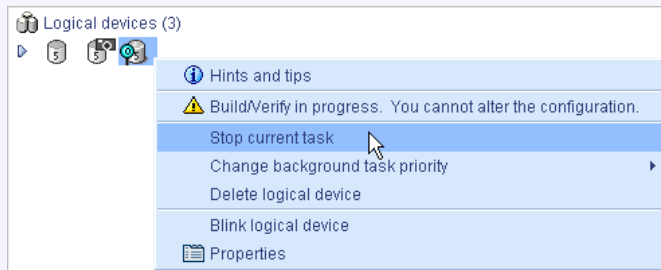

- 6 Repeat Steps 1 to 5 for each controller on your system.
- 7 Continue with [Partitioning and Formatting Your Logical Drives](#) on page 48.

Partitioning and Formatting Your Logical Drives

The logical drives you create appear as physical disk drives on your operating system. You *must* partition and format these logical drives before you can use them to store data.

Note: Logical drives that have not been partitioned and formatted cannot be used to store data.

Refer to your operating system documentation for more information.

Including More Systems in Your Storage Space

Note: Adaptec Storage Manager must be installed on every system that will be part of your storage space.

If you have installed Adaptec RAID controllers on more than one system, to continue building your storage space:

- From each individual system, log in to Adaptec Storage Manager and repeat Steps 1 to 7 to continue building your storage space, *or*
- From your *local* system (the system you're working on), log in to all other systems in your storage space as *remote* systems (see [page 58](#)), then repeat Steps 1 to 7 to continue building your storage space.

The maximum number of supported RAID controllers varies depending on your operating system. See [RAID Controller Support on page 55](#) for more information.

To continue, see [Managing Your Storage Space on page 56](#).

Custom Configuration (Advanced)

Custom configuration helps you build your storage space manually by stepping you through the process of creating logical drives, setting RAID levels, and configuring other settings.

To build your storage space with custom configuration:

- 1 In the Enterprise View, click the controller you want.

Note how many available disk drives are connected to the controller; this information will be helpful as you create logical drives.

- 2 On the toolbar, click **Create**.

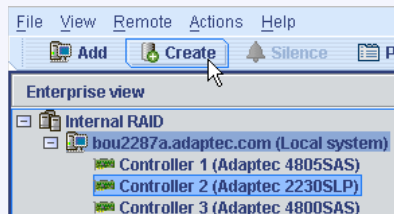

- 3 When the wizard opens, select **Custom configuration...**, then click **Next**.

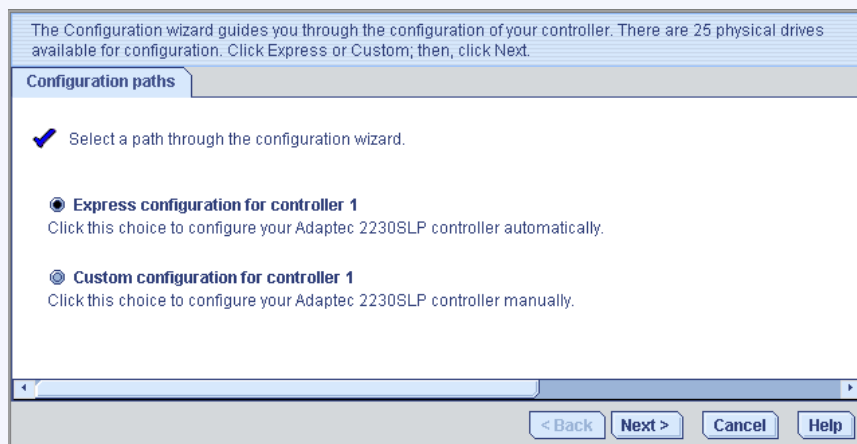

4 Select a RAID level.

The most common RAID levels are listed first; advanced RAID levels are available by clicking **Advanced settings**.

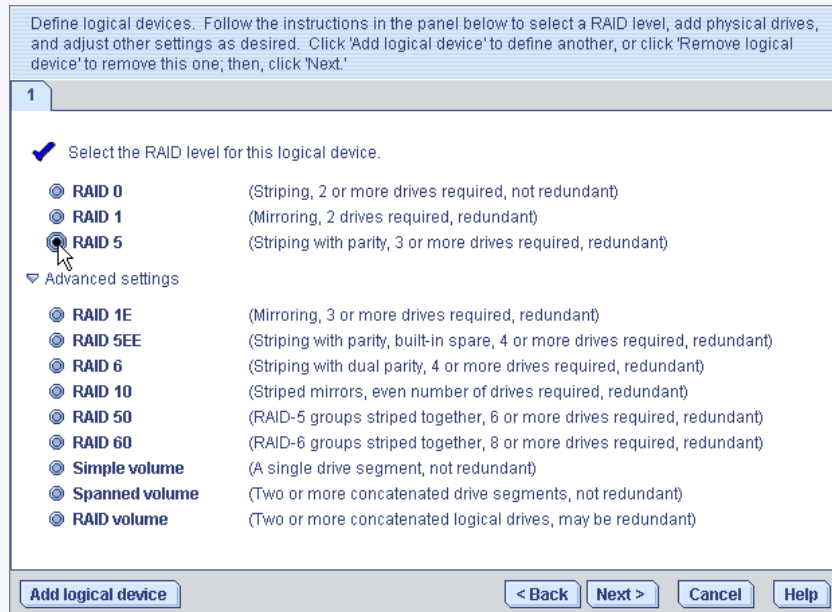

Note: To build a RAID Volume, see [page 54](#). See [Selecting the Best RAID Level on page 157](#) for more information about RAID levels.

5 Click Next.

6 In the Physical Devices panel, select the disk drives you want to use in the logical drive.

Note: Adaptec recommends that you *not* combine SAS and SATA disk drives within the same logical drive. Adaptec Storage Manager generates a warning if you try to create a logical drive using a combination of SAS and SATA disk drives.

Adaptec Storage Manager prompts you to select the correct number of disk drives. For example, this figure illustrates disk drives installed in a system.

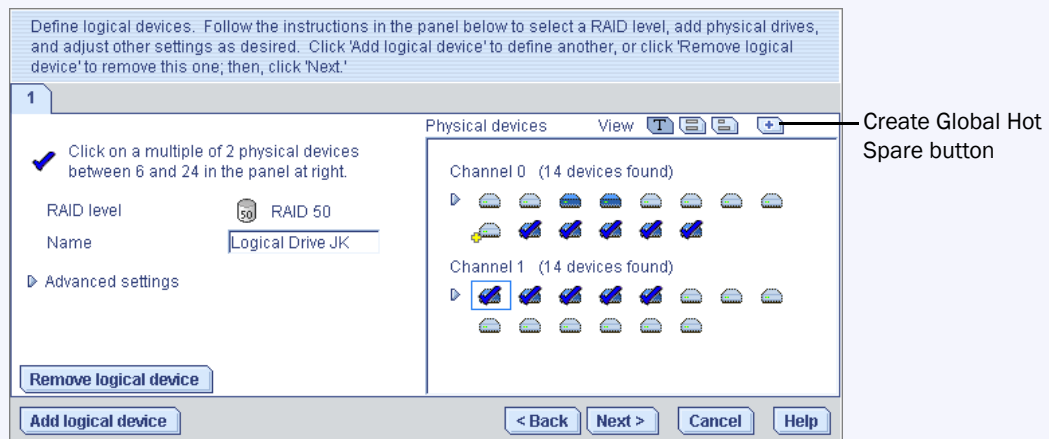

This figure illustrates disk drives installed in two enclosures.

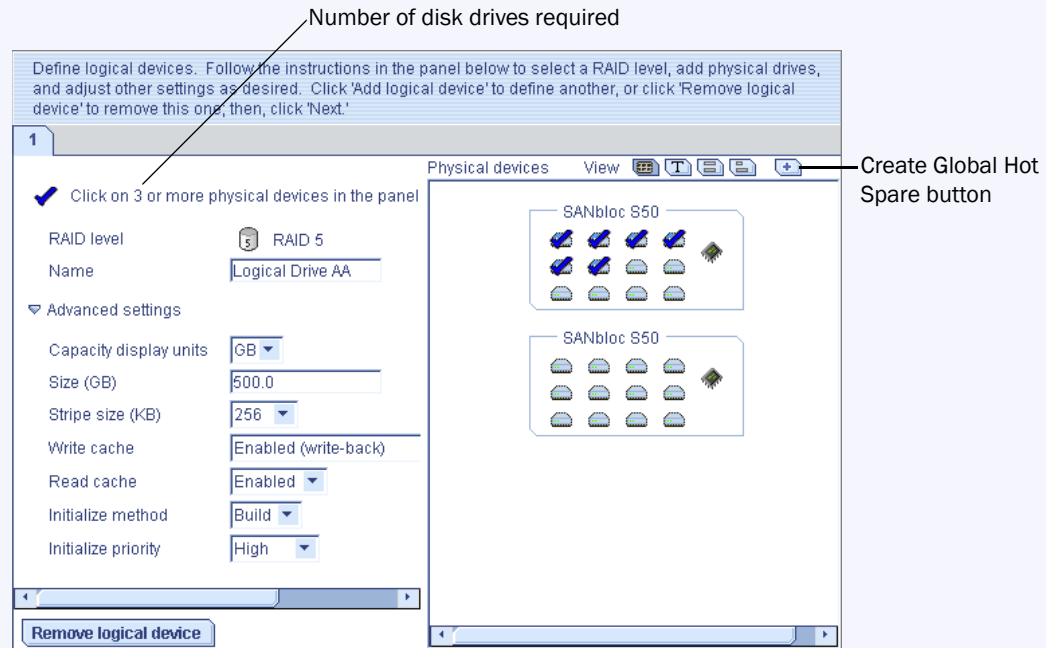

By default, Adaptec Storage Manager automatically sets the size of the logical drive and maximizes the capacity of the disk drives you select. (To set a custom size for the logical drive, see [Step 9](#).)

- 7 (Optional) Create a global hot spare by control-clicking on an available disk drive; alternatively, click the **Create Global Hot Spare** button (shown in the figures on [page 50](#)), then click on an available disk drive.
- 8 A plus sign (+) appears to indicate that the selected drive will be designated as a hot spare, as shown below. To remove a hot-spare designation from a disk drive, control-click it again.



See [Working with Hot Spares on page 81](#) for more information.

- 9 (Optional) Adjust the Advanced Settings:
 - To set a smaller logical drive size—Click **Advanced Settings**, then enter a size for the logical drive in the **Size GB** box. Available space will remain on the selected disk drives. See [Understanding Logical Drives on page 67](#) for more information.
 - To modify other settings—Click **Advanced Settings** and customize the settings as required. See [Fine-tuning Logical Drives on page 71](#) for more information.

- 10 If you have no other available disk drives, skip to [Step 12](#).

If you have available disk drives and want to create additional logical drives, click **Add logical device** to open a new tab in the wizard.

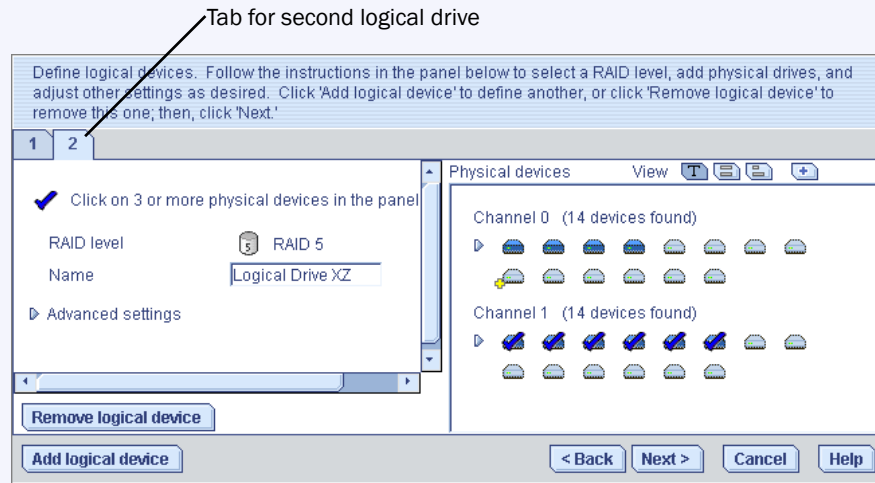

- 11 Repeat Steps 4 to 10 for each logical drive that you want to create on the controller.
- 12 Click **Next**, then review the logical drive settings.

This example shows two logical drives with RAID 5 are ready to be created.

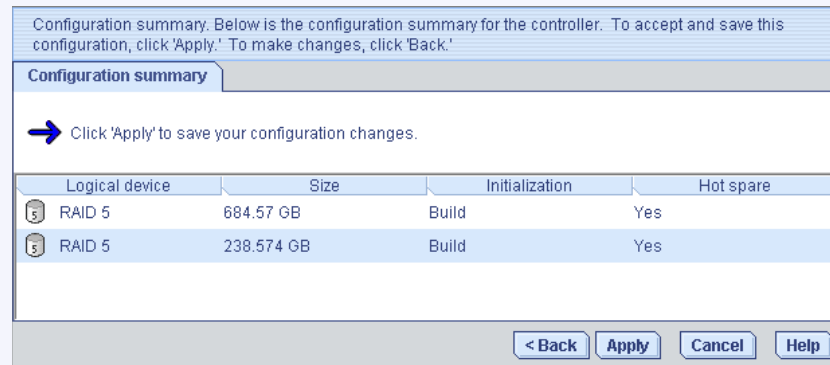

To make changes, click **Back**.

Note: Some operating systems have size limitations for logical drives. Before continuing, verify that the size of the logical drive is appropriate for your operating system. For more information, refer to your operating system documentation.

13 Click **Apply**, then click **Yes**.

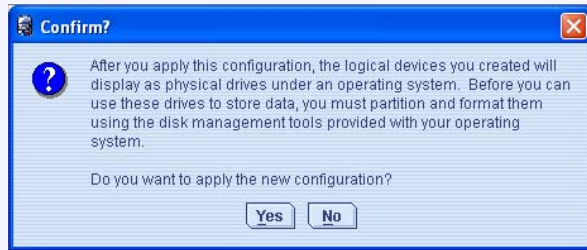

Adaptec Storage Manager builds the logical drive(s), indicated by a magnifying glass moving across the new logical drive icon in the Logical Devices View. The configuration is saved on the Adaptec controller and on the physical drives.

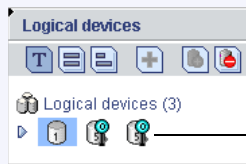

A magnifying glass means that a logical drive is being built. It disappears once the logical drive has been created.

14 Repeat Steps 1 to 13 for each controller on your system.

15 Partition and format your logical drives. See [page 48](#) for more information.

If your storage space comprises one or more Adaptec RAID controllers on a single system, building is complete. Continue with [Managing Your Storage Space on page 56](#).

If you have installed Adaptec RAID controllers on more than one system and wish to add them to your storage space, continue with [Including More Systems in Your Storage Space on page 53](#).

Including More Systems in Your Storage Space

Note: Adaptec Storage Manager must be installed on every system that will be part of your storage space.

If you have installed Adaptec RAID controllers on more than one system, to continue building your storage space:

- From each individual system, log in to Adaptec Storage Manager and repeat Steps 1 to 15 to continue building your storage space, *or*
- From your local system, log in to all the other systems as *remote* systems (see [page 58](#)), then repeat Steps 1 to 15 to continue building your storage space.

The maximum number of supported RAID controllers varies depending on your operating system. See [RAID Controller Support on page 55](#) for more information.

When your storage space is complete, continue with [Managing Your Storage Space on page 56](#).

Building a RAID Volume

A RAID Volume comprises two or more logical drives connected end-to-end. The logical drives in a RAID Volume:

- Must be built using disk drives connected to the same controller.
- Must have the same RAID level assigned.
- Must not be striped together.
- May have equal or different capacities.

To build a RAID Volume:

- 1 Create two or more logical drives that meet the requirements listed at the beginning of this section, and wait for them to build and initialize. For instructions, see [Express Configuration: Building the Easy Way](#) on page 46 or [Custom Configuration \(Advanced\)](#) on page 49.

This example shows two RAID 5 logical drives.

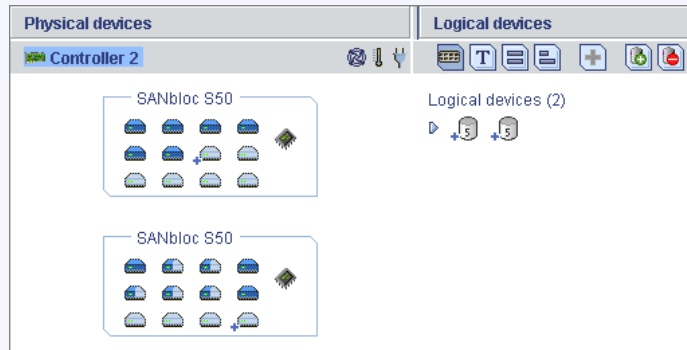

- 2 On the toolbar, click **Create**.
- 3 When the configuration wizard opens, select **Custom configuration...**, then click **Next**.
- 4 Click **Advanced settings**, select **RAID Volume**, then click **Next**.
- 5 In the Logical Devices panel, select the logical drives you want to use in the RAID Volume.

Adaptec Storage Manager prompts you to select the correct number of logical drives.

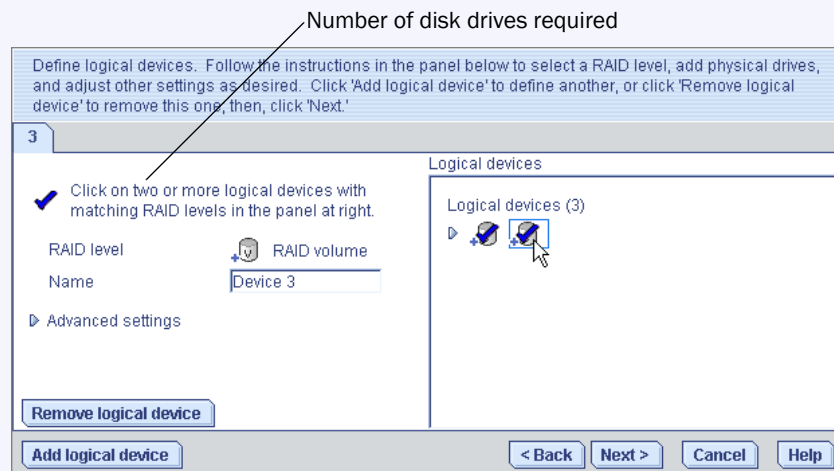

- 6 Modify the Advanced Settings, if required. (See *Fine-tuning Logical Drives* on page 71 for more information.)
- 7 Click **Next** to review the RAID Volume settings. To make changes, click **Back**.

This example shows one RAID Volume ready to be created.

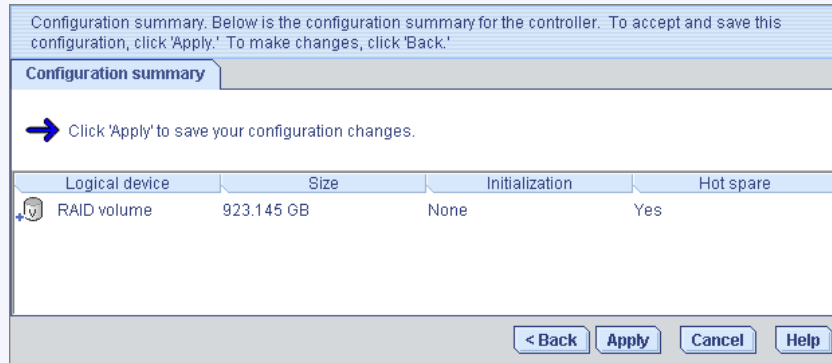

- 8 Click **Apply**, then click **Yes**.

Adaptec Storage Manager builds the RAID Volume. The configuration is saved on the Adaptec controller and on the physical drives. Adaptec Storage Manager replaces the individual logical drives with a single RAID Volume in the Logical Devices View.

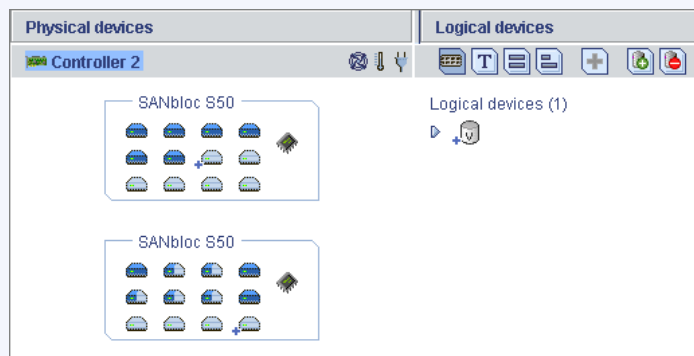

- 9 Partition and format your RAID Volume. See page 48 for more information.

RAID Controller Support

The maximum number of RAID controllers supported by Adaptec Storage Manager varies, depending on your operating system:

- **Windows**—Up to 16 Adaptec RAID controllers
- **Linux**—Up to 12 Adaptec RAID controllers
- **NetWare**—Up to 16 Adaptec RAID controllers
- **UnixWare**—Up to 32 Adaptec RAID controllers
- **OpenServer**—Up to 32 Adaptec RAID controllers

Note: For the most recent operating system support information, visit www.adaptec.com.

Managing Your Storage Space

Once your storage space is built, you can add systems, controllers, and disk drives to meet your changing needs, then create logical drives by repeating the steps in this chapter.

To customize Adaptec Storage Manager and make managing your storage space easier and more effective, continue with [Customizing Adaptec Storage Manager on page 57](#).

To learn how to monitor, manage, and modify your storage space, see these chapters in the rest of this *User's Guide*:

- [Managing Logical Drives and Hot Spares on page 66](#)
- [Protecting Your Data on page 86](#)
- [Monitoring Your Storage Space on page 90](#)
- [Managing Tasks on page 109](#)
- [Working with Display Groups on page 116](#)
- [Managing Controllers, Disk Drives, and Enclosures on page 120](#)
- [Solving Problems on page 133](#)

To find the most commonly asked-about information, see [Quick Answers to Common Questions... on page 146](#).

For help identifying features of Adaptec Storage Manager, see [Buttons and Icons At-a-Glance on page 153](#).



Customizing Adaptec Storage Manager

STEP 5

In this chapter...

Logging In to Remote Systems.....	58
Creating Display Groups.....	60
Setting Preferences and Changing Views	61
Customizing the Adaptec Storage Manager Agent	62

You can customize Adaptec Storage Manager to make managing your storage space easier and more effective:

- Log in to other systems on your network to view and manage all internal RAID storage—controllers, disk drives, and logical drives—from your local system (see [page 58](#)).
- Create display groups to organize related local and remote systems (see [page 60](#)).
- Change display settings, and add or remove features from the main window (see [page 61](#)).
- Change alarm settings, or set the Agent to broadcast event notices from selected systems (see [page 62](#)).

Note: The tasks described in this chapter are optional.

Logging In to Remote Systems

If multiple systems on your network are in your storage space, you can use Adaptec Storage Manager to monitor and manage all of them from one system.

The system that you're working on is called the *local* system. All other systems in your storage space are *remote* systems. 'Local' and 'remote' are relative terms, as shown in the following figure—when you are working on system A (local system), system B is a remote system; when you are working on system B (local system), system A is a remote system.

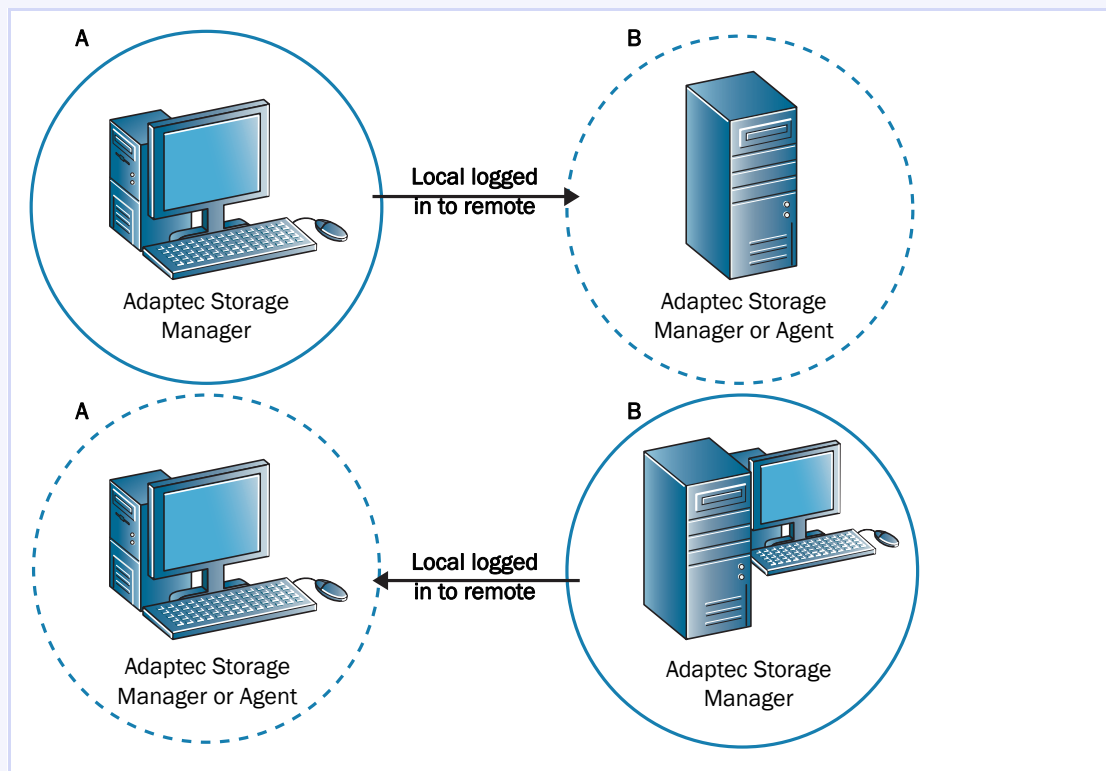

To manage remote systems from the local system, you log in to them. (Adaptec Storage Manager encrypts the user name and password of a remote system during log-in.) Adaptec Storage Manager or the Adaptec Storage Manager Agent (see [page 30](#)) must be running on the remote system before you can log in to it.

When you log in to a remote system, you add that system to the Enterprise View of Adaptec Storage Manager, as shown in this example.

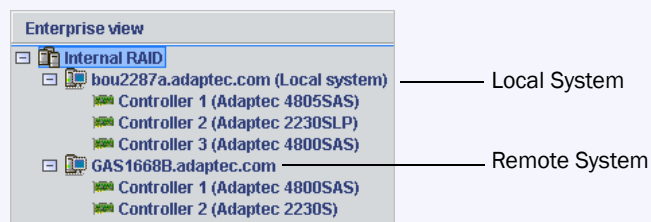

Once you have logged in to a remote system, it is automatically included in the Enterprise View each time you start Adaptec Storage Manager from the local system. You can work with its controllers, disk drives, and logical drives as if they were part of your local system. You must log in with the proper permission level to complete the tasks you wish to perform. (See [Understanding Permission Levels on page 32](#) for more information.)

To log in to a remote system:

- 1 From the menu bar, click **Remote**, then select **Add**.

The Add Managed System window opens.

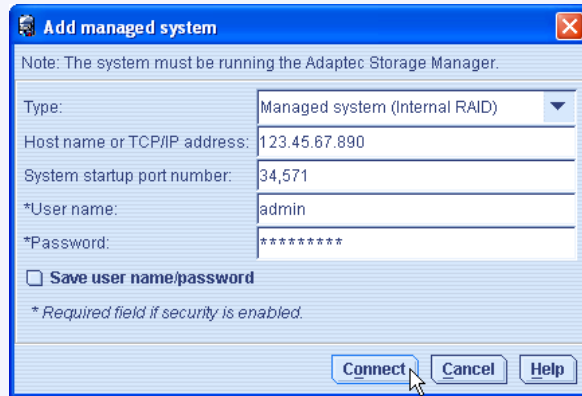

- 2 Ensure that **Managed System (Internal RAID)** is selected in the Type drop-down menu, then enter the host name or TCP/IP address of the remote system.
- 3 Enter the startup port number of the remote system. The default port number is 34571.
- 4 If prompted, enter your user name and password. (User names and passwords are case sensitive.)

To save this user name and password, click inside the **Save user name/password** box.

- 5 Click **Connect**.

Adaptec Storage Manager connects to the remote system and adds it to the list of managed systems in the Enterprise View.

- 6 To manage the remote system, select it in the Enterprise View and enter your user name and password if prompted.

To create logical drives on your remote systems, see [Building Your Storage Space on page 45](#).

Removing a Remote System

If you no longer want to monitor a remote system, you can remove it from the Enterprise View of Adaptec Storage Manager.

Removing a remote system does not cause it to fail.

To remove a remote system:

- 1 In the menu bar of the main window, select **Remote**, select **Remove managed system**, then click the system you want to remove.

The Remove Managed System window opens.

- 2 If you want to continue receiving events from the remote system after it's been removed from the local system, select **Continue to receive events from the remote system** from the drop-down menu.
- 3 Click **OK**.

The remote system is removed from the Enterprise View of Adaptec Storage Manager.

Creating Display Groups

You can organize related local and remote systems into display groups to make managing your storage space easier and more effective.

Systems in a display group appear together in the Enterprise View under the group name.

To create a display group:

- 1 In the Enterprise View, right-click on a system that you want to add to a display group, select **Change display group**, then click **New group**.

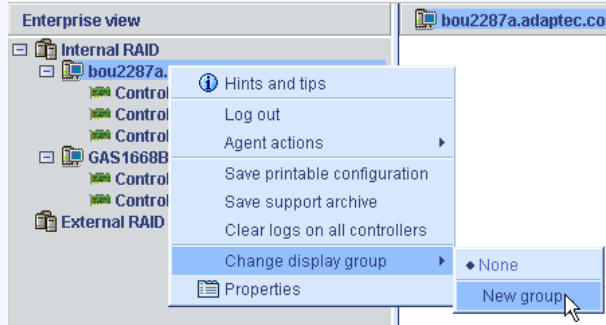

- 2 Enter a name for the new display group, then click **OK**.



The display group is created and the system you selected in [Step 1](#) is added to it.

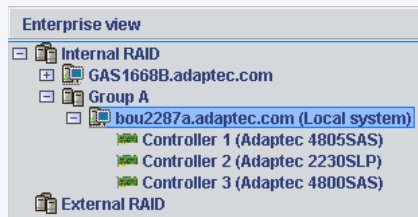

- 3 To add another system to the display group, repeat right-click on that system in the Enterprise View, select **Change display group**, then click the display group name.

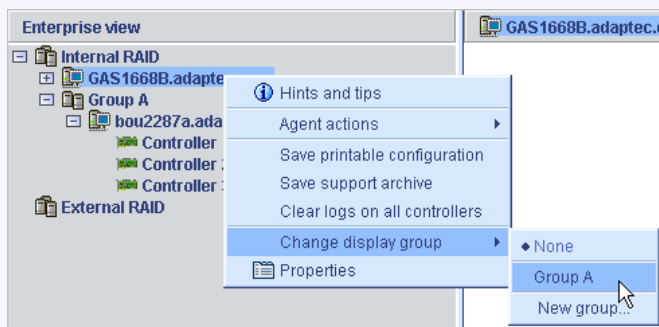

The system is added to the display group.

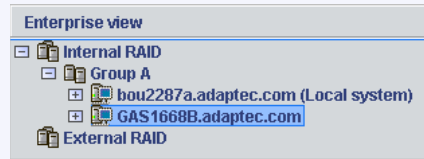

Display groups are sorted alphabetically and appear in the Enterprise View below any systems that are not part of a display group.

A system can belong to only one display group at a time; you can't include the same system in multiple display groups.

For more information, see [Working with Display Groups](#) on page 116.

Setting Preferences and Changing Views

You can customize Adaptec Storage Manager by:

- Sorting the systems in the Enterprise View (see the following section).
- Selecting the standard unit of measure shown for disk drives (see [page 62](#)).
- Excluding the tool bar or status bar from the main window, or turning off the Tool Tips (see [page 62](#)).

Sorting Systems in the Enterprise View

You can set Adaptec Storage Manager to sort systems in the Enterprise View alphabetically or chronologically. By default, systems are listed in alphabetical order. The local system always appears first when you sort objects alphabetically.

To re-sort the Enterprise View:

- 1 In the menu bar of the main window, select **File**, then click **Preferences**.
- 2 Click the **Display options** tab.
- 3 In the **System tree sorting** drop-down menu, select the option you want.

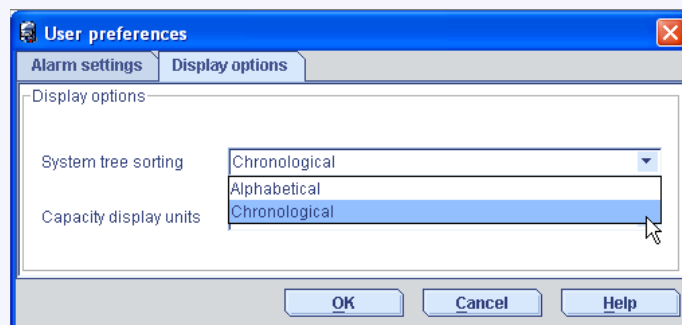

- 4 Click **OK**.

Setting the Standard Unit of Measure

You can set Adaptec Storage Manager to show disk drive capacity in measures of megabytes (MB), gigabytes (GB), or terabytes (TB).

You can choose the Auto-select setting to allow Adaptec Storage Manager to show the most appropriate unit of measure based on disk drive size. This option allows different disk drives to be shown in different units of measure.

By default, disk drives are shown in GB.

To change the standard unit of measure:

- 1 In the menu bar of the main window, select **File**, then click **Preferences**.
- 2 Click the **Display options** tab.
- 3 In the **Capacity display units** drop-down menu, select the option you want.

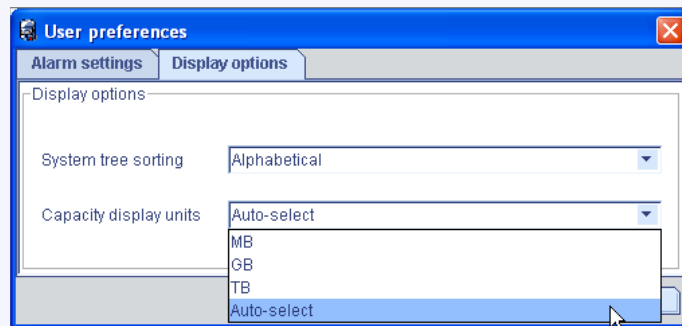

- 4 Click **OK**.

Changing the Main Window Appearance

You can choose to remove the tool bar and status bar from the main Adaptec Storage Manager window to save space on-screen. You can also choose to turn off the Tool Tips that automatically appear when you place your cursor over on-screen items.

To change the appearance of the main window, in the menu bar select **View**. The options in the View menu are toggle switches, which means that they can be selected and deselected by clicking on them.

Customizing the Adaptec Storage Manager Agent

The Adaptec Storage Manager Agent's default settings are suitable for most storage spaces. (See [page 17](#) for more information about the Agent.) However, you can customize the Agent on any system by:

- Setting the Agent to broadcast events on that system to all logged-in users. See [page 63](#).
- Changing the operating system event log setting for that system. See [page 63](#).
- Changing the frequency and duration of the alarm, or choose to disable the alarm for that system. See [page 64](#).
- Changing to Agent base port number on that system. See [page 64](#).

Any changes you make to the Agent settings affect the selected system only and are not applied to all systems in your storage space.

Broadcasting Event Alerts from a System

You can set the Adaptec Storage Manager Agent to send event alerts about a specific system to all users who are logged into your storage space network. You might want to do this if your storage space isn't managed by a dedicated person, or if that particular system is off-site or isn't connected to a monitor.

Event alerts signal to everyone working on the storage space that technical assistance is required for that system.

For more information, see [Broadcasting Event Alerts to Users](#) on page 105.

Changing a System's Event Log Setting

By default, all Warning- and Error-level events on a system are recorded in the operating system event log. You can customize the level of events that are recorded, or you can disable operating system event logging.

To change or disable operating system event logging on a system:

- 1 In the Enterprise View, select the system.
- 2 Click the **Configure** button, then click **General Settings**.

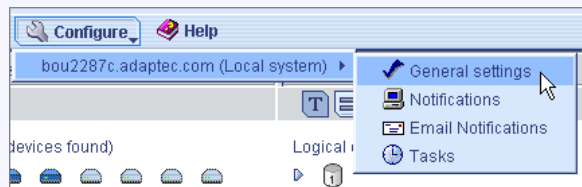

The Adaptec Storage Manager Agent General Settings window opens for the system you selected.

- 3 In the Save events in OS log drop-down menu, select the type of event logging that you want, then click **Save changes**.

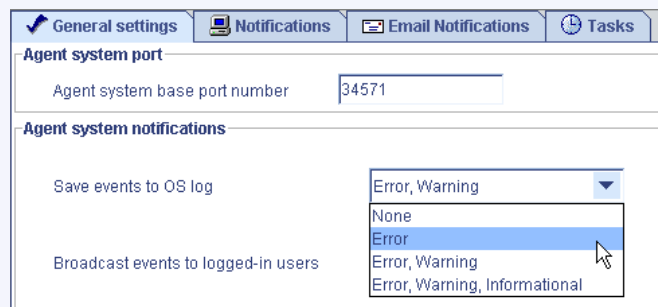

- 4 Restart Adaptec Storage Manager to apply the new setting.

Changing a System's Audible Alarm Settings

Warning- and Error-level events on a system (see [page 92](#)) trigger an audible alarm, a series of beeps which sound every five minutes until the event is resolved.

You can change the frequency and duration of the alarm, or choose to disable the alarm on any system. For information about using the audible alarm, see [page 107](#).

To change alarm settings on a system:

- 1 In the Enterprise View, select the system.
- 2 Click the **Configure** button, then click **General Settings** (see the figure in [Step 2 on page 63](#)).

The Adaptec Storage Manager Agent General Settings window opens for the system you selected.

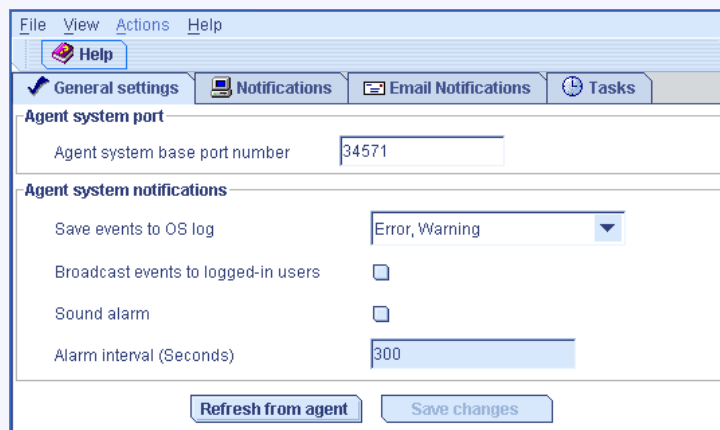

- 3 Edit the alarm settings as required. (Select or deselect **Sound alarm**; change the alarm interval time.)

⚠ Caution: If you disable the alarm, no audible signal will sound on that system when a Warning- or Error-level event occurs.

- 4 Click **Save changes**.
- 5 Restart Adaptec Storage Manager to apply the new settings.

Changing a System's Agent Base Port Number

Adaptec Storage Manager uses six consecutive ports to access remote systems: 34571, 34572, 34573, 34574, 34575, and 34576. The default port number for the Agent is 34571. If your system has a conflict with these ports, change the base port to a different port number.

To change the Agent base port number:

- 1 In the Enterprise View, select the system.
- 2 Click the **Configure** button, then click **General Settings** (see the figure in [Step 2 on page 63](#)).
- 3 The Adaptec Storage Manager Agent General Settings window opens for the system you selected. Enter a new Agent system base port number.
- 4 Click **Save changes**.
- 5 Restart Adaptec Storage Manager *and* the Adaptec Storage Manager Agent to apply the new setting.

Part II: Using Adaptec Storage Manager

Chapter 6: Managing Logical Drives and Hot Spares (page 66)

Chapter 7: Protecting Your Data (page 86)

Chapter 8: Monitoring Your Storage Space (page 90)

Chapter 9: Managing Tasks (page 109)

Chapter 10: Working with Display Groups (page 116)

Chapter 11: Managing Controllers, Disk Drives, and Enclosures (page 120)

Chapter 12: Configuring SNMP Support (page 130)

Chapter 13: Solving Problems (page 133)

Managing Logical Drives and Hot Spares

6

In this chapter...

Understanding Logical Drives	67
Creating Logical Drives	68
Fine-tuning Logical Drives	71
Verifying Logical Drives	74
Increasing the Capacity of a Logical Drive.....	77
Changing the RAID Level of a Logical Drive	79
Deleting a Logical Drive.....	80
Working with Hot Spares.....	81

This chapter explains how to manage logical drives and hot spares associated with Adaptec RAID controllers.

To create a logical drive, see *Building Your Storage Space* on page 45.

Understanding Logical Drives

A logical drive is a group of physical disk drives that appears to your operating system as a single drive that can be used for storing data.

A logical drive can comprise one or more disk drives and can use part or all of each disk drive's capacity.

It is possible to include the same disk drive in two different logical drives by using just a portion of the space on the disk drive in each, as shown in the following figure.

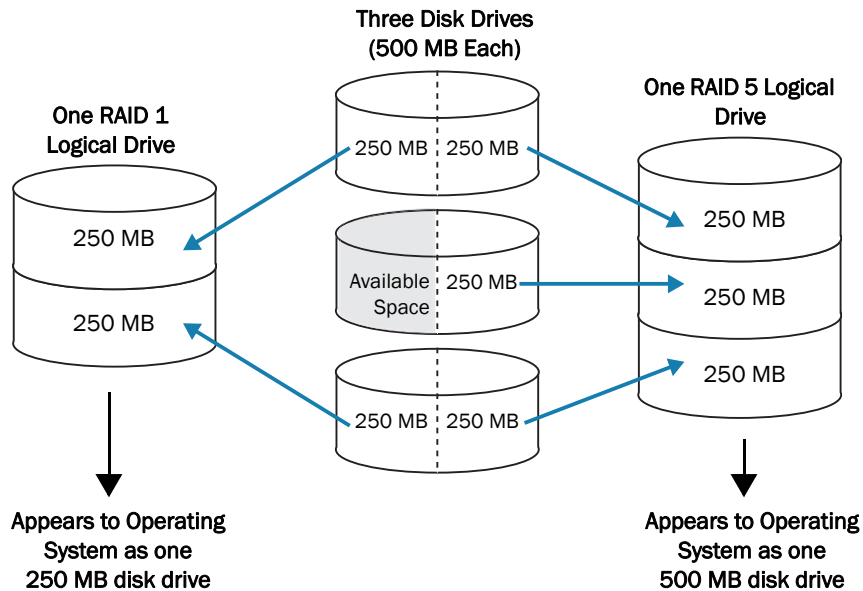

Disk drive space that has been assigned to a logical drive is called a *segment*. A segment can include all or just a portion of a disk drive's space. A disk drive with one segment is part of one logical drive, a disk drive with two segments is part of two logical drives, and so on. A segment can be part of only one logical drive. When a logical drive is deleted, the segments that comprised it revert to available space (or *free segments*).

A logical drive can include redundancy, depending on the RAID level assigned to it. (See [Selecting the Best RAID Level on page 157](#) for more information.)

Once a logical drive has been created, you can change its RAID level or increase its capacity to meet changing requirements. You can also protect your logical drives by assigning one or more hot spares to them. (See [page 81](#) for more information.)

Creating Logical Drives

For basic instructions for creating logical drives, see *Building Your Storage Space* on page 45.

This section describes three additional scenarios for creating logical drives:

- Setting the size of a new logical drive (see the following section)
- Including different-sized disk drives in a logical drive (see [page 69](#))
- Creating a logical drive using available *segments* of disk drives (see [page 70](#))

Setting the Size of a Logical Drive

As described in [Step 6 on page 50](#), Adaptec Storage Manager automatically sets the size of a new logical drive to maximize the capacity of the disk drives that it comprises. However, you can choose to set the size for a new logical drive. You may want to do this to maximize your available disk drive space, or allocate available space to more than one logical drive.

To set the size of a logical drive:

1 Complete Steps **1** through **6** in *Custom Configuration (Advanced)* on page 49.

2 Click **Advanced Settings**.

The maximum size of the logical drive appears in the Size (GB) box.

3 Enter the new size for the logical drive. The size you enter must be less than or equal to the maximum size.

4 Click **Next**.

5 Review the logical drive settings, click **Apply**, then click **Yes**.

Adaptec Storage Manager builds the logical drive. The configuration is saved in the Adaptec controller and in the physical drives.

If the disk drives you used to create this logical drive have available space left over, you can use them to create a new logical drive (see [page 70](#)), or to expand an existing logical drive (see [page 77](#)).

Including Different-sized Disk Drives in a Logical Drive

You can combine disk drives of different sizes in the same logical drive. If the logical drive includes redundancy, however, the size of each segment can be no larger than the size of the smallest disk drive. (See [Selecting the Best RAID Level on page 157](#) for more information about redundancy.)

Note: Adaptec recommends that you *not* combine SAS and SATA disk drives within the same logical drive. Adaptec Storage Manager generates a warning if you try to create a logical drive using a combination of SAS and SATA disk drives.

To create a logical drive with disk drives of different sizes, follow the instructions in [Building Your Storage Space on page 45](#). When the logical drive is created, it appears similar to the example in the next figure, where a RAID 5 logical drive includes two 16.95 GB disk drives and two 9.77 GB disk drives.

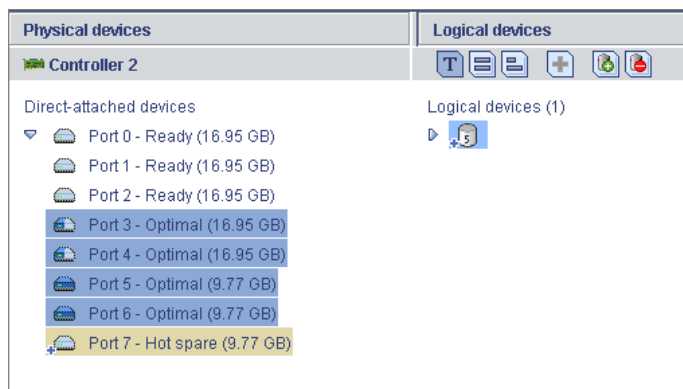

The Full Size Capacity View of the same RAID 5 logical drive shows that the two larger disk drives still have available space (free segments, indicated in light-blue) that is not part of a logical drive.

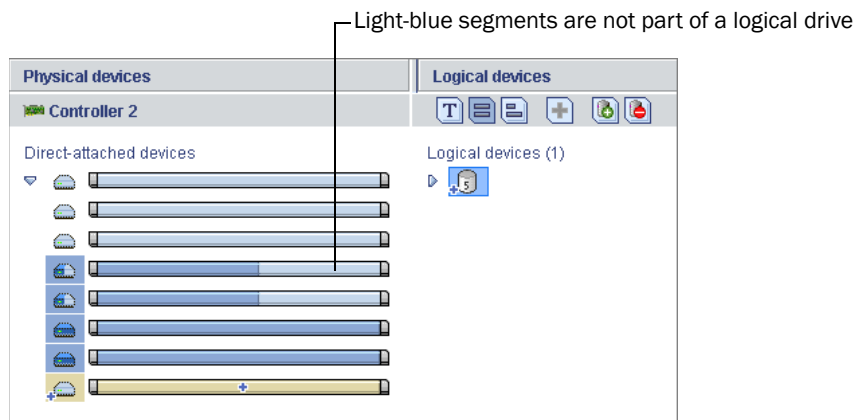

You can include a disk drive's available space in a new logical drive (see [page 70](#)), or add it to an existing logical drive (see [page 77](#)).

Creating a Logical Drive Using Available Space

Free segments on a disk drive can be used to create a new logical drive. (A segment can only be used in one logical drive at a time.)

To create a logical drive using free segments on disk drives:

- 1 Complete Steps 1 through 5 in *Custom Configuration (Advanced)* on page 49.
- 2 In the Physical Devices panel, select the disk drives and/or free disk drive segments you want to use in the logical drive.

Note: Adaptec recommends that you *not* combine SAS and SATA disk drives within the same logical drive. Adaptec Storage Manager generates a warning if you try to create a logical drive using a combination of SAS and SATA disk drives.

In this example, two free disk drive segments (indicated in blue) are used to create a RAID 1 logical drive.

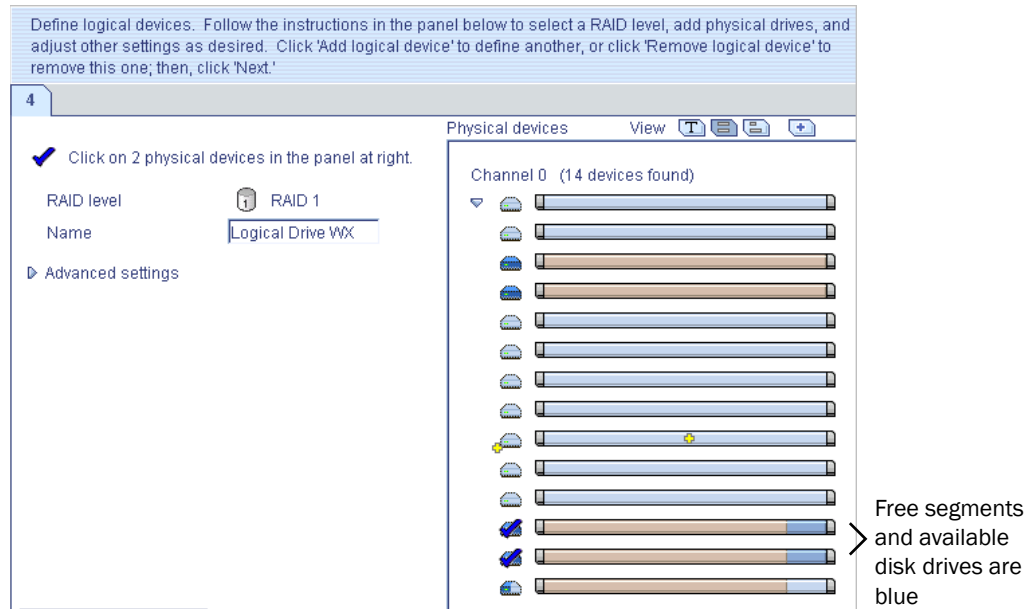

- 3 Click **Next**.
- 4 Review the logical drive settings.
- 5 Click **Apply**, then click **Yes**.

Adaptec Storage Manager builds the logical drive. The configuration is saved in the Adaptec controller and in the physical drives.

Fine-tuning Logical Drives

You can fine-tune a new or existing logical drive to meet your needs by changing its name or adjusting the Advanced settings described in this section. (Not all options are available for all controllers or all RAID levels.)

Renaming a Logical Drive

To change the name of a logical drive:

- 1 In the Enterprise View, click the controller associated with the logical drive.
- 2 In the Logical Devices View, click the logical drive.
- 3 In the menu bar, select **Actions**, then click **Change logical device name**.

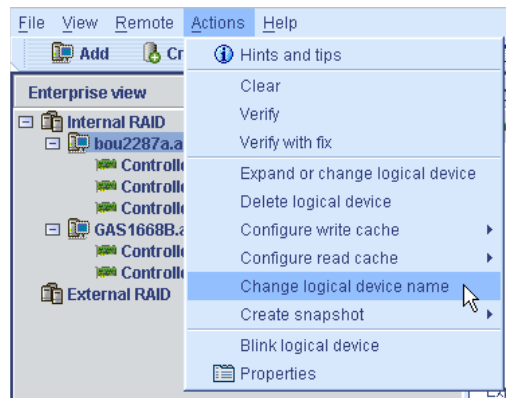

- 4 Type the new name, then click **OK**.

The logical drive is updated with its new name.

Adjusting a Logical Drive's Advanced Settings

Note: The default settings in Adaptec Storage Manager are optimal for most users and storage spaces. Only advanced users should change the settings described in this section.

To fine-tune a logical drive:

- 1 Open the list of Advanced settings.

If you are creating a *new* logical drive, follow the instructions in [Step 6 on page 50](#).

If you are modifying an *existing* logical drive:

- a In the Enterprise View, click the controller associated with the logical drive.
- b In the Logical Devices View, click the logical drive.
- c In the menu bar, select **Actions**, then click **Expand or change logical device** (shown in the figure in [Step 3 on page 71](#)).
- d Click **Next**, then click **Advanced settings**.

- 2 Modify the available settings as required for your logical drive (not all options are available for all controllers or all RAID levels):
 - Logical drive size (see [page 68](#))
 - Stripe size (see the following section)
 - Write cache (see further down on this page)
 - Read cache (see [page 73](#))
 - Initialize priority (see [page 73](#))
 - Initialize method (see [page 73](#))
- 3 Click **Next**.
- 4 To apply the changes immediately, click **Apply**.

To schedule the changes for later, click **Schedule**, then set the date and time. (For more information, see [Scheduling a Task on page 110](#).)

Changing the Stripe Size

The *stripe size* is the amount of data (in KB) written to one partition before the controller moves to the next partition in a logical drive.

Stripe size options vary, depending on your controller. Normally, the default stripe size provides the best performance.

For RAID 6 and RAID 60 logical drives, the more disk drives there are in the logical drive, the fewer the stripe size options.

Changing the Write Cache Setting

The *write cache* setting determines when data is stored on a disk drive and when the controller communicates with the operating system.

- **Disabled (write-through)**—The controller sends (or *writes*) the data to a disk drive, then sends confirmation to the operating system that the data was received. Use this setting when performance is less important than data protection.
- **Enabled (write-back)**—The controller sends confirmation to the operating system that the data was received, then writes the data to a disk drive. Use this setting when performance is more important than data protection and you aren't using a battery-backup cache. *Enabled* is the default setting.

Note: (*RAID 10, 50, and 60 only*) All logical drives within a RAID 10/50/60 logical drive must have the same write cache setting—either all write-through or all write-back.

To quickly change the write cache setting:

- 1 Click the logical drive you want.
- 2 In the menu bar, select **Actions**, click **Configure write cache**, then select **Enabled** or **Disabled** as required.

The write cache setting is changed.

Changing the Read Cache Setting

When *read caching* is enabled, the controller monitors the read access to a logical drive and, if it sees a pattern, pre-loads the cache with data that seems most likely to be read next, increasing performance.

- **Enabled**—The controller transfers data from the logical drive to its local cache in portions equal to the stripe size. Use this setting for the best performance when workloads are steady and sequential. *Enabled* is the default setting.
- **Disabled**—The controller transfers data from the logical drive to its local cache in portions equal to the system I/O request size. Use this setting for the best performance when workloads are random or the system I/O requests are smaller than the stripe size. (For more information about system I/O requests, refer to your operating system documentation.)

To quickly change the read cache setting:

- 1 Click the logical drive you want.
- 2 In the menu bar, select **Actions**, click **Configure read cache**, then select **Enabled** or **Disabled** as required.

The read cache setting is changed.

Changing the Initialize Priority

The Initialize Priority setting determines the priority for the initialization of the logical drive. The default setting is *High*, which means that the logical drive is initialized as quickly as possible.

Changing the Initialize Method

The Initialize Method setting determines how a logical drive is *initialized* (prepared for reading and writing), and how long initialization will take. The settings are presented in order of slowest to fastest method.

- **Build**—(slowest) For RAID 1 logical drives, data is copied from the primary drive to the mirror drive; for RAID 5 logical drives, parity is computed and written. *Build* is the default setting for most logical drives (see *Quick* method below).

Adaptec Storage Manager performs build initializations in the background; you can use the logical drive immediately.

- **Clear**—Every block in the logical drive is overwritten, removing all existing data. You can't use the logical drive until the initialization is complete.
- **Quick**—(fastest) The logical drive is made available immediately. *Quick* is the default setting for RAID 1, RAID 1EE, and RAID 10 logical drives.

Verifying Logical Drives

To ensure that there are no data problems on your logical drives, it is important to *verify* them. When you verify a logical drive, Adaptec Storage Manager checks it for inconsistent or bad data and then fixes any problems. (You can also choose to verify a logical drive without fixing it.)

Logical drives with no redundancy (for instance, RAID 0 logical drives) do not need to be verified.

In Adaptec Storage Manager, logical drive verification can occur in different ways, depending on your controller:

- **Automatic verification**—If your controller supports build initialization, Adaptec Storage Manager automatically verifies all new redundant logical drives. No manual verification is required.

To see if your controller supports build initialization, right-click the controller in the Enterprise View and click **Properties**.

- **Manual verification**—If your controller doesn't support build initialization, a Warning-level event notice appears in the Event Viewer prompting you to verify a logical drive before you begin to use it. To verify a logical drive manually, see [Verifying and Fixing a Logical Drive on page 75](#).
- **Background verification**—If your controller supports background consistency check, Adaptec Storage Manager continually and automatically checks your logical drives once they're in use.

To see if your controller supports background consistency check, right-click the controller in the Enterprise View, then click **Properties**. To enable or disable background consistency check, see [page 76](#).

Note: If your controller doesn't support background consistency check, Adaptec highly recommends that you verify your logical drives weekly, following the instructions in [Verifying and Fixing a Logical Drive on page 75](#).

Verifying and Fixing a Logical Drive

Note: To verify a logical drive without fixing it, see [page 76](#).

While Adaptec Storage Manager verifies and fixes a logical drive, you can't complete any other tasks on the controller. Because the verification can take a long time to complete, you may want to schedule it as a task to be completed overnight or on a weekend.

To verify and fix a logical drive:

- 1 In the Enterprise View, click the controller associated with the logical drive.
- 2 In the Logical Devices View, click the logical drive.
- 3 In the menu bar, select **Actions**, then click **Verify with fix**.

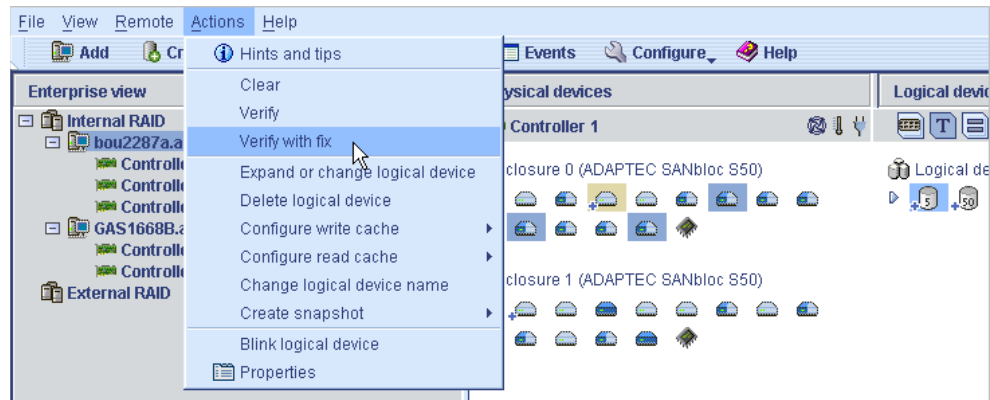

- 4 To begin the verification immediately, click **Yes**.

To schedule the verification, click **Schedule**, then set the date and time. You can also choose to set the verification as a recurring task. (For more information, see [page 110](#).)

Note: Don't power off the system while the verification is in progress. If you do, the verification will stop.

While the verification is in progress, the logical drive is shown as an animated icon (as shown at right) to indicate that the task is in progress.



When the verification is complete, an event notice is generated in the local system's event log (and broadcast to other systems, if you have event notification set up—see [Using Notifications to Monitor Status on page 93](#)).

You can now continue working on the controller.

Verifying a Logical Drive (Without Fix)

Note: To verify *and fix* a logical drive, see [page 75](#).

While Adaptec Storage Manager verifies a logical drive, you can't complete any other tasks on the controller associated with that logical drive. Because verification takes a long time to complete, you may want to schedule it as a task to be completed overnight or on a weekend.

To verify a logical drive:

- 1 In the Enterprise View, click the controller associated with the logical drive.
- 2 In the Logical Devices View, click the logical drive.
- 3 In the menu bar, select **Actions**, then click **Verify** (shown in the figure in [Step 3 on page 75](#)).
- 4 To begin the verification immediately, click **Yes**.

To schedule the verification for later, click **Schedule**, set the date and time, then click **Apply**. You can also set the verification to recur. (For more information, see [page 110](#).)

Note: Don't power off the system while the verification is in progress. If you do, the verification will stop.

While the verification is in progress, the logical drive is shown as an animated icon (as shown at right) to indicate that the task is in progress.



When the verification is complete, an event notice is generated in the local system's event log (and broadcast to other systems, if you have event notification set up—see [Using Notifications to Monitor Status on page 93](#)).

You can now continue working on the controller.

Enabling/Disabling Background Consistency Check

If your controller supports background consistency check, Adaptec Storage Manager continually and automatically checks your logical drives once they're in use. (To see if your controller supports background consistency check, right-click the controller in the Enterprise View, then click **Properties**.)

To enable or disable background consistency check:

- 1 In the Enterprise View, click the controller.
- 2 In the menu bar, select **Actions**, then click **Enable (Disable) background consistency check**.

The controller is updated with the new setting.

Increasing the Capacity of a Logical Drive

You can add more disk drive space to a logical drive to increase its capacity (or *expand* it).

Note: The maximum size of a logical drive varies by controller. Refer to your controller's documentation for more information.

The expanded logical drive must have a capacity that's greater than or equal to the original logical drive.

To increase the capacity of a logical drive:

- 1 In the Enterprise View, click the controller associated with the logical drive.
- 2 In the Logical Devices View, click the logical drive.
- 3 In the menu bar, select **Actions**, then click **Expand or change logical device** (shown in the figure in [Step 3 on page 75](#)).

A wizard opens to help you modify the logical drive.

- 4 Click **Next**.
- 5 Click on the disk drive(s) or disk drive segments you want to add to the logical drive.

Note: Adaptec recommends that you *not* combine SAS and SATA disk drives within the same logical drive. Adaptec Storage Manager generates a warning if you try to create a logical drive using a combination of SAS and SATA disk drives.

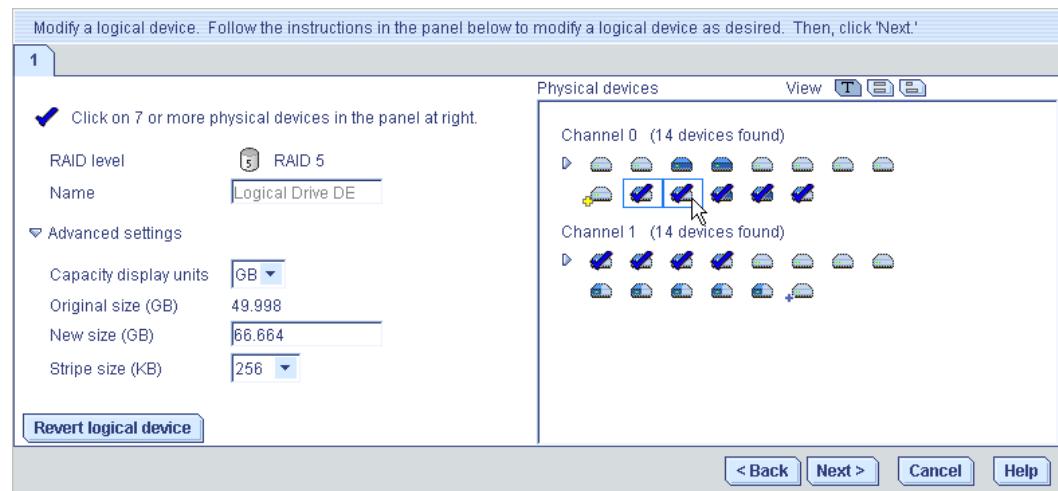

If you want to remove a specific disk drive or segment and replace it with another one (for instance, replace a smaller disk drive with a larger one), click on the disk drive you want to remove.

An X indicates that the selected disk drive will be removed from the logical drive, and you are prompted to select another disk drive (of greater or equal size) to replace it.

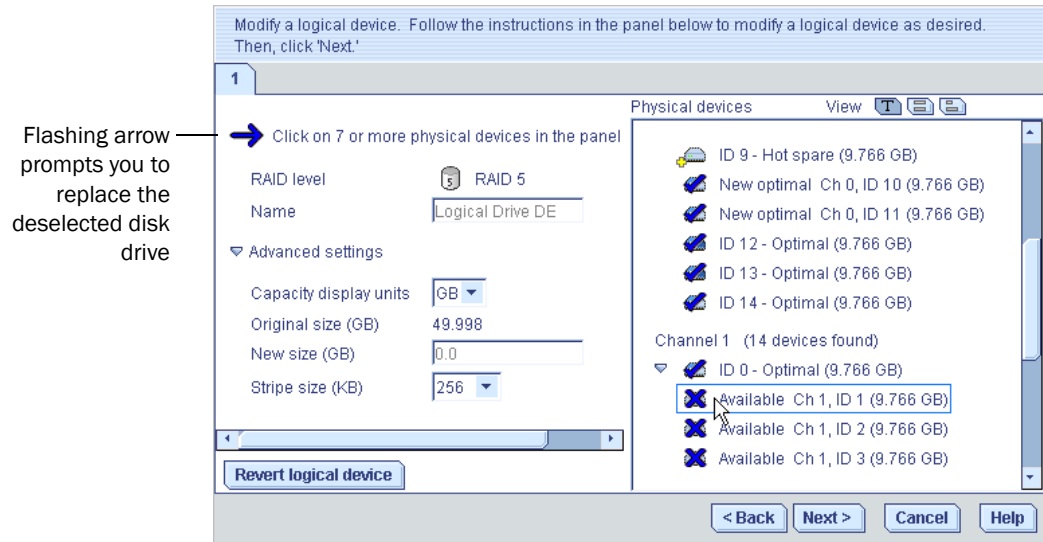

- 6 Modify the Advanced Settings, if required. (See *Fine-tuning Logical Drives* on page 71.)
- 7 Click Next.
- 8 Review the new logical drive settings. To make changes, click **Back**.

Note: Some operating systems have size limitations for logical drives. Before you save the configuration, verify that the size of the logical drive is appropriate for your operating system.

- 9 To update your logical drive immediately, click **Apply**, then click **Yes**.

To schedule the changes for later, click **Schedule**, set the date and time, then click **Apply**. (For more information, see page 110.)

Extending a Partition on a Logical Drive

(*Windows 2003, Windows XP, and Windows 2000 only*) If you have expanded a logical drive, you can extend the partition on that logical drive to use the newly added space. Refer to your operating system instructions for more information.

Changing the RAID Level of a Logical Drive

As your requirements change, you can change the RAID level of your logical drives to suit your needs. You may want to do this to add redundancy to protect your data, or improve data availability for speedier access to your data. See [Selecting the Best RAID Level on page 157](#) for more information.

Changing the RAID level normally requires one or more disk drives to be added to or removed from the logical drive. Adaptec Storage Manager won't allow you to continue unless you have the right number of disk drives available.

To change the RAID level of a logical drive:

- 1 In the Enterprise View, click the controller associated with the logical drive.
- 2 In the Logical Devices View, click the logical drive.
- 3 In the menu bar, select **Actions**, then click **Expand or change logical device** (see [page 77](#)).

A wizard opens to help you change the RAID level.

- 4 Select a new RAID level, then click **Next**. Only valid options are offered.

In the example shown in this section, a RAID 1 logical drive is being changed to a RAID 5 logical drive.

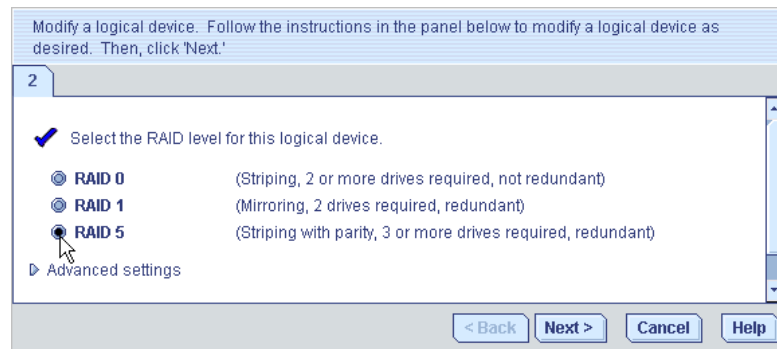

- 5 In the Logical Devices panel, select the disk drives you want to use in the modified logical drive.

Note: Adaptec recommends that you *not* combine SAS and SATA disk drives within the same logical drive. Adaptec Storage Manager generates a warning if you try to create a logical drive using a combination of SAS and SATA disk drives.

Adaptec Storage Manager prompts you to select the correct number of disk drives.

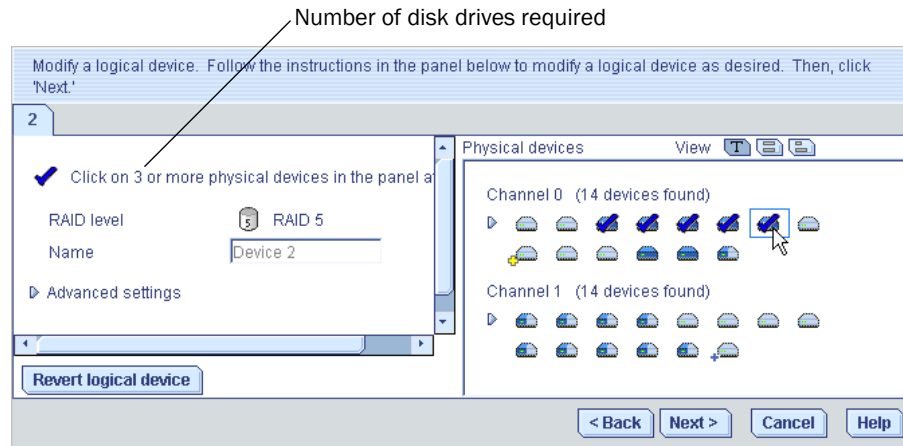

If you want to remove a specific disk drive and replace it with another one (for instance, replace a smaller disk drive with a larger one), click on the disk drive you want to remove. An X indicates that the selected disk drive will be removed from the logical drive.

- 6 Modify the Advanced Settings, if required. (See [Fine-tuning Logical Drives on page 71.](#))
- 7 Click Next.
- 8 Review the new logical drive settings. To make changes, click Back.

Note: Some operating systems have size limitations for logical drives. Before you save the configuration, verify that the size of the logical drive is appropriate for your operating system.

- 9 To update your logical drive immediately, click **Apply**, then click **Yes**.

To schedule the changes for later, click **Schedule**, set the date and time, then click **Apply**. (For more information, see [page 110.](#))

Deleting a Logical Drive

Caution: When you delete a logical drive, you lose all data stored on that logical drive.

To delete a logical drive:

Ensure that you no longer need the data stored on the logical drive.

- 1 In the Enterprise View, click on the controller associated with the logical drive.
- 2 In the Logical Devices View, click the logical drive.

- 3 In the menu bar, select **Actions**, then click **Delete logical device**.

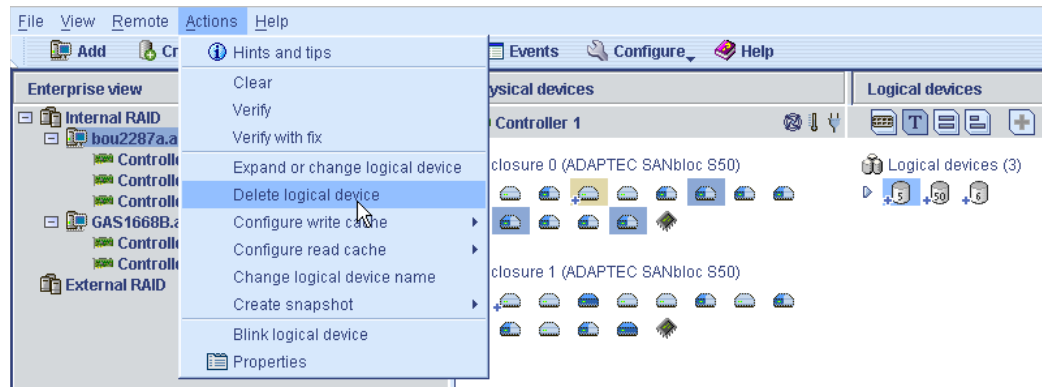

- 4 When prompted, click **Yes** to delete the device, or **No** to cancel the deletion.

If you click **Yes**, the logical drive is deleted. The disk drives or drive segments included in the logical drive become available, and can be used to create a new logical drive (see [page 70](#)), or to expand an existing logical drive (see [page 77](#)).

Working with Hot Spares

A *hot spare* is a disk drive that automatically replaces any failed drive in a logical drive, and can subsequently be used to rebuild that logical drive. (For more information on recovering from a disk drive failure, see [page 135](#).)

Hot Spare Limitations

- You can't create a hot spare for RAID 0 logical drives, simple volumes, or spanned volumes.
- You can't create a hot spare from a disk drive that is already part of a logical drive.
- You should select a disk drive that is at least as big as the largest disk drive it might replace.
- Adaptec recommends that you *not* designate a SAS hot spare for a logical drive comprising SATA disk drives, or a SATA hot spare for a logical drive comprising SAS disk drives.

Dedicated Spare or Global Spare?

A *global* hot spare is not assigned to a specific logical drive and will protect any logical drive on the controller (except RAID 0 logical drives). You can designate a global hot spare before or after you build logical drives on a controller; you can also designate a global hot spare while you're creating a logical drive. To designate a global hot spare, see [page 82](#).

A *dedicated* hot spare is assigned to one or more specific logical drives and will only protect those logical drives. (A dedicated hot spare that has been assigned to protect more than one logical drive is called a *pool* spare.) You must create the logical drive before you can assign a dedicated hot spare. To assign a dedicated hot spare or pool hot spare, see [page 83](#).

Designating a Global Hot Spare

This section describes how to designate a global hot spare before or after you build a logical drive.

Note: To designate a global hot spare while you're creating a logical drive, see [Step 6 on page 50](#).

To designate a global hot spare:

- 1 In the Enterprise View, click the controller on which you want a global hot spare.
- 2 In the Physical Devices View, click the disk drive you want to designate as a hot spare. (See [Hot Spare Limitations](#) for help selecting a disk drive.)
- 3 Click the Create global hot-spare drive button (shown at right).

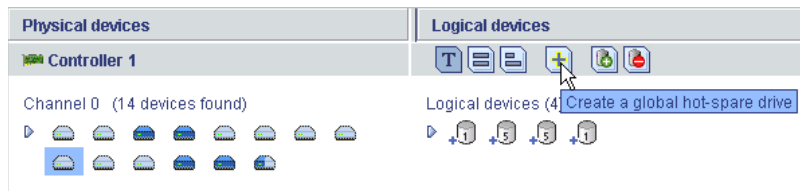

A plus sign appears beside the selected disk drive, indicating that it's designated as a hot spare. (A yellow plus sign indicates an error. See [What Do the Hot Spare Icons Mean?](#) on [page 83](#) for help solving the problem.)

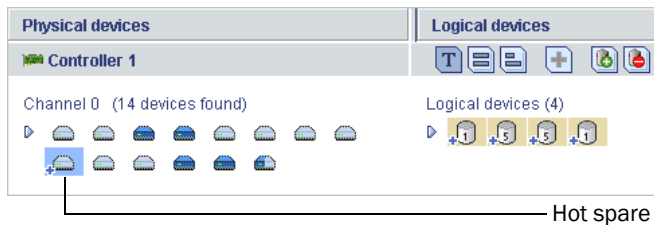

Any other logical drives created on the controller will automatically be protected by that global hot spare.

Assigning a Dedicated Hot Spare or Pool Hot Spare

A dedicated hot spare is assigned to one or more specific logical drives. (A dedicated hot spare that has been assigned to protect more than one logical drive is called a *pool* hot spare.)

Note: You must create the logical drive before you can assign a dedicated hot spare.

To assign a dedicated or pool hot spare:

- 1 In the Enterprise View, click the controller on which you want a dedicated hot spare.
- 2 In the Physical Devices View, click the disk drive you want to designate as a hot spare. (See [Hot Spare Limitations on page 81](#) for help selecting a disk drive.)
- 3 In the menu bar, select **Actions**, then click **Create dedicated hot-spare drive for**, then click the name of the logical drive (in this example, Device 2).

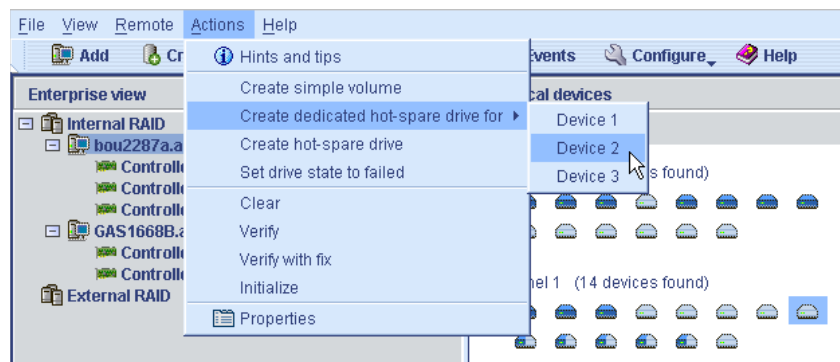

A plus sign appears beside the selected disk drive, indicating that it's designated as a dedicated hot spare. (A yellow plus sign indicates an error. See [What Do the Hot Spare Icons Mean? on page 83](#) for help solving the problem.)



- 4 To use the same dedicated hot spare to protect another logical drive (create a pool hot spare), repeat [Step 2](#) and [Step 3](#).

What Do the Hot Spare Icons Mean?

Icon	Explanation	Action
	Healthy global or dedicated hot spare	No action required.
	Error on hot spare: <ul style="list-style-type: none"> • Hot spare is not assigned to any logical drives • Hot spare is too small to protect the logical drive(s) it's assigned to • Global hot spare was designated before any logical drives were built 	<ul style="list-style-type: none"> • Create at least one logical drive on the same controller • Designate larger disk drive as hot spare • Create at least one logical drive on the same controller
	Hot spare has been built into a logical drive after disk drive failure	Designate replacement or other available disk drive as new hot spare; remove 'hot spare' designation from disk drive (see Removing or Deleting a Dedicated Hot Spare)

Removing or Deleting a Dedicated Hot Spare

You can delete a dedicated hot spare or remove it from a logical drive. You may want to do this to:

- Make disk drive space available for another logical drive.
- Make a dedicated hot spare into a global hot spare.
- Remove the ‘hot spare’ designation from a disk drive that is no longer being used as a hot spare. (When a hot spare is built into a logical drive after a disk drive failure, it retains its ‘hot spare’ designation even though it can no longer protect the logical drives it’s assigned to. See [Recovering from a Disk Drive Failure on page 135](#) for more information.)

To remove or delete a dedicated hot spare:

- 1 In the Enterprise View, click the controller associated with the hot spare.
- 2 In the Physical Devices View, click the hot spare.
- 3 In the menu bar, select **Actions**, then click **Delete dedicated hot-spare drive**, or click **Remove dedicated hot-spare drive from**, then select the logical drive you want (in this example, Device 2).

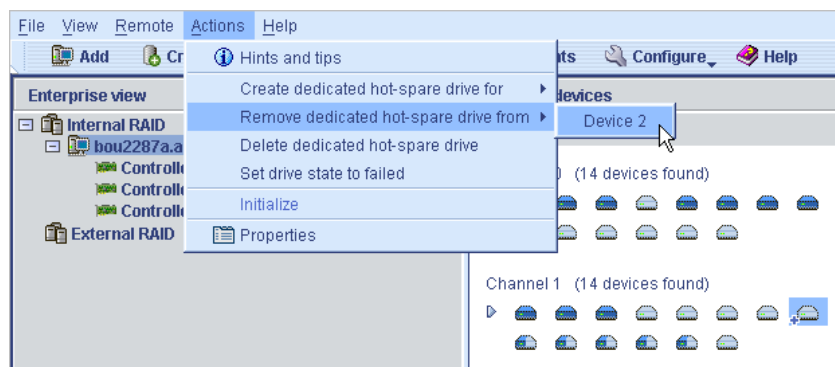

The hot spare is deleted or removed, and the disk drive becomes available for other uses in your storage space.

Deleting a Global Hot Spare

You can delete a global hot spare. You may want to do this to:

- Make disk drive space available for another logical drive.
- Make a global hot spare into a dedicated hot spare.
- Remove the ‘hot spare’ designation from a disk drive that is no longer being used as a hot spare. (When a hot spare is built into a logical drive after a disk drive failure, it retains its ‘hot spare’ designation even though it can no longer protect the logical drives it’s assigned to. See [Recovering from a Disk Drive Failure on page 135](#) for more information.)

To remove or delete a dedicated hot spare:

- 1 In the Enterprise View, click the controller associated with the hot spare.
- 2 In the Physical Devices View, click the hot spare.

- 3 In the menu bar, select **Actions**, then click **Delete hot-spare drive**.

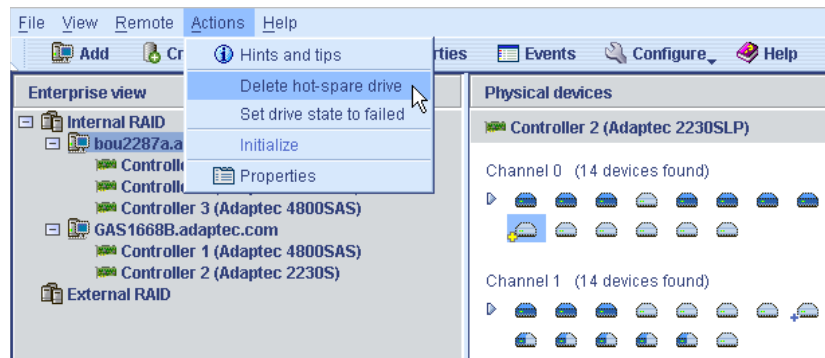

The hot spare is deleted and the disk drive becomes available for other uses in your storage space.

Protecting Your Data

7

In this chapter...

Creating a Snapshot	87
Enabling Copyback	89

In addition to the standard (RAID 0, RAID 1, RAID 5, RAID 10, RAID 50) and enhanced (RAID 1E, RAID 5EE, RAID 6, RAID 60) RAID levels, controllers with the Adaptec Advanced Data Protection Suite include two additional methods of protecting the data on your storage space.

This chapter describes how to use snapshot and copyback to protect your stored data.

Creating a Snapshot

Note: Snapshot is an upgrade feature; if the snapshot feature is locked, see [Adding Enhanced Features on page 20](#) for information on purchasing a feature key. Snapshots are only supported on Windows and Linux operating systems.

A *snapshot* is a frozen image of a logical drive at a particular point in time. You can copy the data on one logical drive to another logical drive by creating a snapshot. You may want to do this if you want to back up your data to tape, clone a drive, or copy the data to multiple servers.

There are two snapshot options:

- **Snapshot Backup**—Copies all data on a logical drive so that it can be moved from one server to another. See [page 88](#).
- **Snapshot Nobackup**—Creates a temporary copy of a logical drive for tape backup and reference (uses less system resources than Snapshot Backup). See [page 88](#).

To delete an existing snapshot, see [page 89](#).

Snapshot Limitations

- You can create a snapshot on systems running Windows or Linux only.
- You can create a snapshot of only one controller at a time; you can't create a snapshot that includes multiple controllers.
- The *source* logical drive (the logical drive that you're copying) and the *target* logical drive (the logical drive that you're copying to) must be on the same controller.
- The source and target logical drives may have the same or different RAID levels.
- You can create up to four snapshots on each controller.
- The size of the target logical drive must be greater than or equal to the size of the source logical drive.
- You can't take a snapshot of a booted operating system volume.
- You can't modify any information on a snapshot.

Creating a Snapshot with Backup

Caution: To avoid a corrupted snapshot, ensure that no files are open or in use on the source logical drive before you begin this task.

To create a snapshot with backup:

- 1 In the Logical Devices View, click the logical drive you want to copy.
- 2 In the menu bar, select **Actions**, click **Create snapshot**, select **with backup to**, then click the name of the target logical drive (in this example, Device 3).

Note: Only logical drives that can support the snapshot are listed.

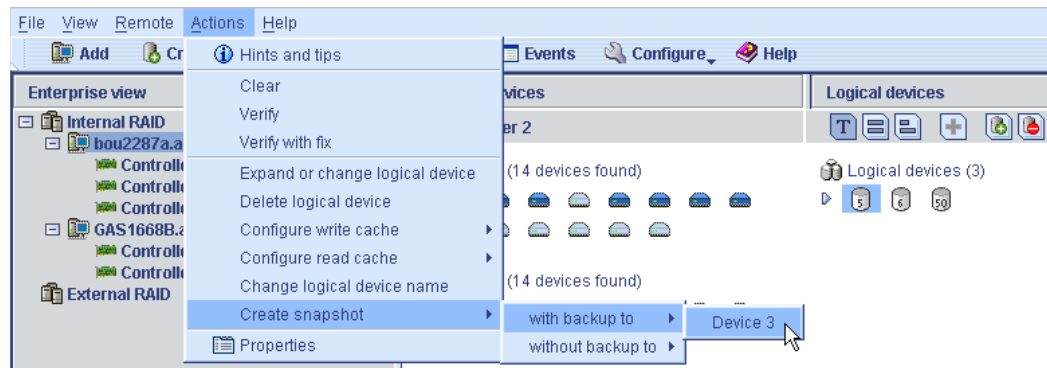

- 3 Click **Yes** to create the snapshot.

The snapshot is created on the target logical drive, which now appears in Adaptec Storage Manager with a camera icon beside it.

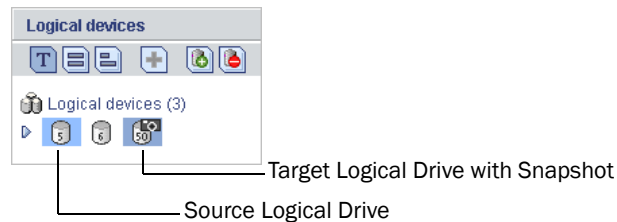

Creating a Snapshot Without Backup

To create a snapshot without backup:

- 1 In the Logical Devices View, right-click the logical drive you want to copy.
- 2 In the menu bar, select **Actions**, select **Create snapshot**, select **without backup to** (see [Step 2](#) above), then click the name of the target logical drive.
- 3 Click **Yes** to create the snapshot.

The snapshot is created on the target logical drive, which now appears in Adaptec Storage Manager with a camera icon beside it, as shown above.

- 4 Use an operating system-level or third-party data backup tool to move the snapshot onto a tape drive or other server.

Deleting a Snapshot

When a snapshot is no longer needed, you can delete it from Adaptec Storage Manager.

To delete a snapshot:

- 1 In the Logical Devices View, right-click the snapshot you want to delete.
- 2 Click **Remove snapshot**.



- 3 Click **Yes** to delete the snapshot.

The snapshot is deleted.

Enabling Copyback

When a logical drive is rebuilt using a hot spare (see [page 135](#)), data from the failed drive is transferred to the hot spare. When *copyback* is enabled, data is moved back to its original location once the controller detects that the failed drive has been replaced. Once the data is copied back, the hot spare becomes available again.

Copyback is disabled by default.

To enable copyback, right-click the controller, then click **Enable or Disable copy back mode**. (The copyback setting is a toggle switch.)

Monitoring Your Storage Space



In this chapter...

- Monitoring Options 91
- Checking Activity in Your Storage Space 91
- What Do the Status Icons Mean?..... 92
- Using Notifications to Monitor Status 93
- Broadcasting Event Alerts to Users..... 105
- Managing Enclosure Status..... 106
- Silencing and Testing the Audible Alarm 107

This chapter describes how Adaptec Storage Manager helps you monitor your storage space.

Monitoring Options

Adaptec Storage Manager provides many ways to monitor the status of your storage space:

- **Event Viewer**—The main window of Adaptec Storage Manager includes an Event Viewer that provides at-a-glance status information about activity occurring in your storage space. (See the following section.)
- **Status Icons**—Three basic icons (information, warning, and error) appear in the Event Viewer and in the main Adaptec Storage Manager window to help you quickly identify problems. (See [page 92](#).)
- **Notification Manager and Email Notification Manager**—Notification utilities help you monitor these activities on local and remote systems (see [page 93](#) and [page 99](#)):
 - Progress of scheduled tasks, such as logical drive verifications.
 - Changes in the status of the physical components of your storage space, such as disk drives.
 - Changes to the local system, such as the expansion of a logical drive expansion or the creation of a hot spare.
- **Audible Alarm**—A series of beeps sounds whenever a serious event occurs on your storage space. (See [page 107](#).)
- **Properties Button**—You can check the status of any component in your storage space by using the Properties button. (See [page 121](#).)

Checking Activity in Your Storage Space

From your local system, you can see status information and messages about the activity (or *events*) occurring in your storage space by looking at the Event Viewer, which displays a log of events. Status is indicated by an icon in the left-hand column, as shown in the following figure. (The icons are described in [What Do the Status Icons Mean?](#) on [page 92](#).)

Double-click any event to see more details in an easier-to-read format. Click **Next** to see the next event in the list.

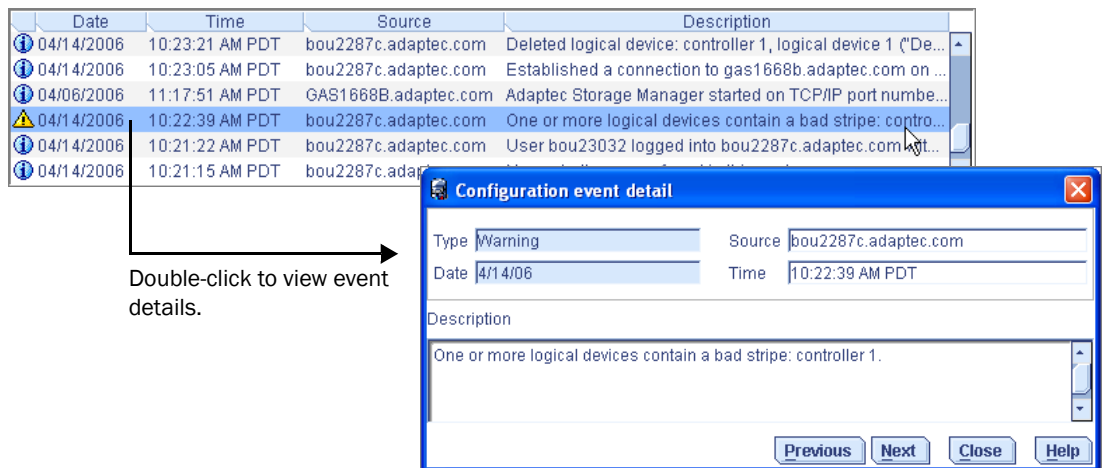

You can monitor activity on, and the status of, remote systems from the local system by using Adaptec Storage Manager's two notification utilities to broadcast messages—the Notification Manager (see [page 93](#)) and the Email Notification Manager (see [page 99](#)).

Viewing the Full List of Events

To open a full-screen version of the event log, click the **Events** button (shown at right).



To make it easier to find a specific event, click on the column heads to sort the events. (Sort events by status icons to help you find specific Error- or Warning-level events.)

Clearing the Event Log

To clear all event logs belonging to all controllers in a selected system:

- 1 In the Enterprise View, click on the system you want.
- 2 In the menu bar, select **Actions**, then select **Clear logs on all controllers**.
- 3 Click **Yes** to clear the log.

The log for the selected system is cleared, except for one event reporting that the log was cleared.

What Do the Status Icons Mean?

Adaptec Storage Manager indicates event status with icons. This table lists the three categories, or types, of events based on severity.

Icon	Status	Examples
	Information	<ul style="list-style-type: none"> ● The local system successfully connected to a remote system. ● A logical drive was created. ● A hot spare was created. ● A logical drive was deleted.
	Warning	<ul style="list-style-type: none"> ● A logical drive is in a degraded state. ● A disk drive is being rebuilt. ● A controller is not responding to an enclosure. ● An enclosure fan or power supply has failed.
	Error	<ul style="list-style-type: none"> ● A controller has failed. ● A logical drive has failed. ● A hot spare has failed. ● A disk drive within a logical drive has failed. ● An enclosure is overheating. ● Multiple fans or power supplies within an enclosure have failed. ● An enclosure is not responding.

Warning- and Error-level icons appear next to components (such as systems and logical drives) affected by a failure or error, creating a trail, or *rapid fault isolation*, that helps you identify the source of a problem when it occurs. See [Identifying a Failed or Failing Component on page 134](#) for more information.

Note: All Warning- and Error-level events also cause the audible alarm to sound. See [page 107](#) for more information.

Using Notifications to Monitor Status

You can set up Adaptec Storage Manager to broadcast messages (or *notifications*) to selected remote systems and users when an event, such as the creation of a logical drive or the failure of a disk drive, occurs on the local system. (For more information about event types, see [page 91](#).)

You can set up one or both of these types of notifications for any system in your storage space:

- **Event notifications**—Messages about a system are sent to the Event Viewer of other systems in your storage space. See the following section.
- **Email notifications**—Messages about a system are sent by email to specified users. See [page 99](#).

Setting up Event Notifications

Event notifications are messages about events on one system that are sent to the Event Viewer of another system in your storage space. These messages, called *logged notifications*, can help you monitor activity on your entire storage space from a single local station, and are especially useful in storage spaces that include multiple systems running the Adaptec Storage Manager Agent only.

Logged notifications include status information and identify which system (or *source*) an event occurred on. For instance, in this example, the Event Viewer indicates that two logical drives were added to a system named ‘gas1668b’.

	Date	Time	Source	Description
ⓘ	04/14/2006	11:01:44 AM PDT	GAS1668B.adaptec.com	Added logical device: controller 1, logical device 4 ("Logi...
ⓘ	04/14/2006	11:01:44 AM PDT	GAS1668B.adaptec.com	Added logical device: controller 1, logical device 3 ("Logi...
ⓘ	04/14/2006	11:01:41 AM PDT	GAS1668B.adaptec.com	Successfully applied the new configuration: controller 1.
✖	04/14/2006	10:53:48 AM PDT	bou2287c.adaptec.com	Could not clear the event logs for system bou2287c.ada...
✖	04/14/2006	10:53:32 AM PDT	GAS1668B.adaptec.com	Could not clear the event logs for system GAS1668B.ad...
ⓘ	04/14/2006	10:40:46 AM PDT	bou2287c.adaptec.com	Reconfiguration complete: controller 1, logical device 3 (...)

Logged notifications are *not* sent to all systems in your storage space. In the Notification Manager, you can specify which systems will send and receive logged notifications; then, you can add or delete systems as your storage space grows and changes.

Opening the Notification Manager and Adding Systems

This section describes how to set up event notifications for one system in your storage space. You must complete the tasks in this section for *each* individual system that you’ll be monitoring with logged notifications.

To set up event notifications for a system:

- 1 Note this information for each system that will *receive* event notifications about the selected system:
 - Host name or TCP/IP address
 - TCP/IP port number (or the default, 34571)

- 2 In the Adaptec Storage Manager tool bar, click **Configure**, select the system you want, then click **Notifications**.

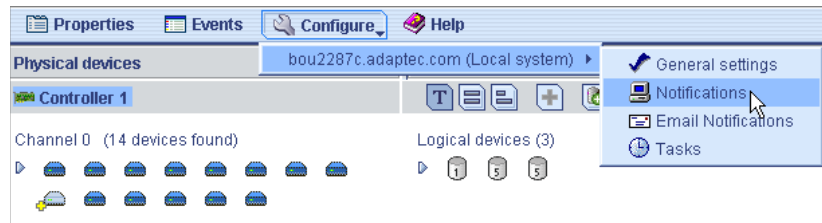

The Notification Manager opens on the Notifications tab of a new window. The local system is automatically included on the Notification List—by default, all local events are listed in the local Event Viewer.

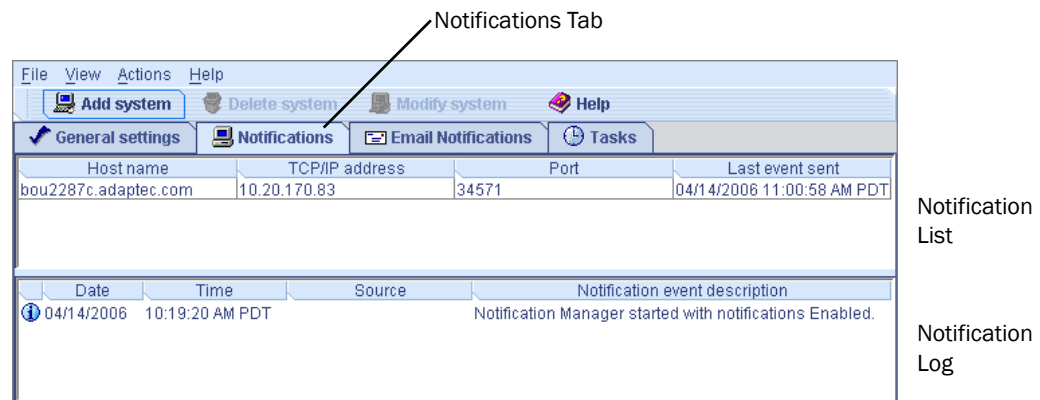

- 3 To the Notification List, add the names of the other systems in your storage space that will receive event notifications generated by the system you selected in [Step 2](#):
 - a In the tool bar, click **Add system**.
 - b In the Add System window, enter the host name or TCP/IP address of the first system. If you are not using the default port number, 34571, enter the TCP/IP port. Then, click **Add**.

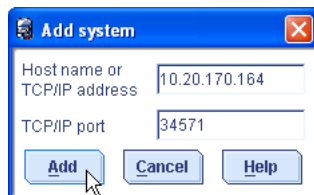

- c If you want more than one system to receive the event notifications, repeat [Step b](#) as required.

- d When done, click **Cancel** to close the Add System window.

The systems you added appear in the Notification List. Although you can't sort the list, you can reorganize the columns by clicking and dragging the column heads.

Host name	TCP/IP address	Port	Last event sent
bou2287c.adapte	10.20.170.83	34571	07/18/2005 11:04:56 AM ...

You can specify which levels of events are sent to individual systems by following the instructions in [Modifying a System's Address, Host Name, or Notification Level on page 96](#).

- 4 Close the Notifications window when you're done.

Note: You can access other utilities in this window, such as the Task Manager (see [Managing Tasks on page 109](#)), by clicking their tabs.

- 5 Repeat Steps 1 to 4 for each system you want to monitor with event notifications.

Sending a Test Event

To ensure that a system is receiving logged notifications, you can send a test event.

To send a test event:

- 1 Open the Notification Manager. (See [page 93](#).)

Note: You can also access the Notification Manager by selecting the system you want in the Enterprise View, then (on the menu bar) clicking **Actions > Agent actions > Configure > Notifications** tab.

- 2 In the Notification List, click on the system you want to send a test event to.

Note: You can only send a test event to one system at a time.

- 3 On the menu bar, select **Actions**, then click **Send test event**.

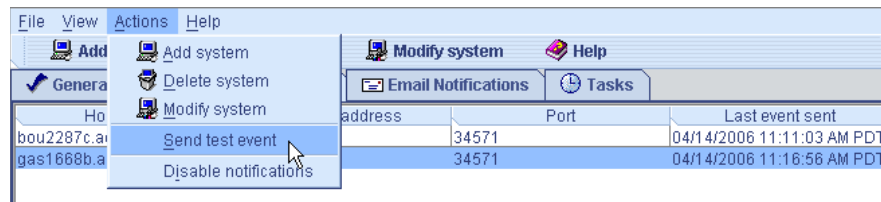

The test event is sent. A message appears indicating either that the test event was sent successfully or that the test failed. (Click **OK** to clear the message.)

If the test is successful, the receiving system beeps once, and its Event Viewer shows that a test event was received.

Date	Time	Source	Description
05/04/2005	02:55:45 PM PDT	bou2287c	This is a test event.
05/04/2005	11:55:02 AM PDT	bou2287c	Verify complete: controller 1, logic...
05/04/2005	11:54:05 AM PDT	bou2287c	Verifying: controller 1, logical devic...
05/04/2005	11:54:05 AM PDT	bou2287c	Added logical device: controller 1, ...
05/04/2005	11:54:00 AM PDT	bou2287c	Successfully applied the new conf...
05/04/2005	11:54:00 AM PDT	bou2287c	Created a hot-spare drive: controll...
05/04/2005	08:42:55 AM PDT	bou2287c	A controller has been added to th...

Test event

If the test fails:

- a Ensure that the receiving system is powered on and running Adaptec Storage Manager.
- b Open the receiving system's System Properties window (see [Step 3 on page 96](#)) and double-check the TCP/IP address and port number.
- c Try sending the test event again.

Managing the Event Notification List

This section describes how to manage systems in the Notification List:

- To add a system to the Notification List, see [page 93](#).
- To modify a system's connection information, see the following section.
- To remove a system from the Notification List, see [page 96](#).

Modifying a System's Address, Host Name, or Notification Level

If you want to specify the notification level for a system, or if the TCP/IP information or host name of a system changes, update its properties in the Notification Manager.

Note: Does this system receive event notifications from more than one other system? Ensure you enter the updated information in the Notification Manager of all affected systems.

To modify system information:

- 1 Open the Notification Manager. (See [page 93](#).)
- 2 In the Notification List, click on the system you want to modify.
- 3 In the System Properties window, enter the new information or select a new notification level in the Event Type drop-down menu, then click OK.

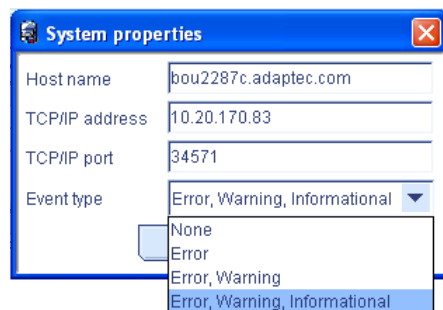

The Notification List shows the modified information.

Removing a System from the Notification List

You can remove any system (including the local system) from the Notification List. Once a system has been removed, logged notifications from the local system are no longer sent to it.

To remove a system from the Notification List:

- 1 Open the Notification Manager. (See [page 93](#).)
- 2 In the Notification List, click on the system you want to remove.
- 3 In the tool bar, click **Delete system**.

- 4 Click **Yes** to confirm the deletion.

The system is removed from the Notification List.

Monitoring and Managing the Notification Log

The Notification Log displays status information and messages about the Notification Manager itself, such as whether notifications were sent successfully or not.



This section describes how to manage the Notification Log and use it to monitor the logged notifications being sent:

- Using the Notification Log (see the following section).
- Clearing the Notification Log (see [page 98](#)).

Using the Notification Log

By default, notification events are listed in the order they occurred, with the most recent event first. To make it easier to find a specific event, click on the column heads to sort the events. You can also reorganize the columns by clicking and dragging the column heads (see the figure on [page 95](#)).

The Notification Log uses icons to show the status of events. These icons also appear in the Event Viewer of the remote systems.

Icon	Status	Explanation and Solution
	Information	The Notification Manager successfully connected and sent the event. No action required.
	Error	The Notification Manager did not successfully connect to a system or send an event. Ensure that the correct host name and TCP/IP address of the receiving system is correct (see page 96).

Double-click on an event to see basic information about it. Click **Next** to see the next event in the list.

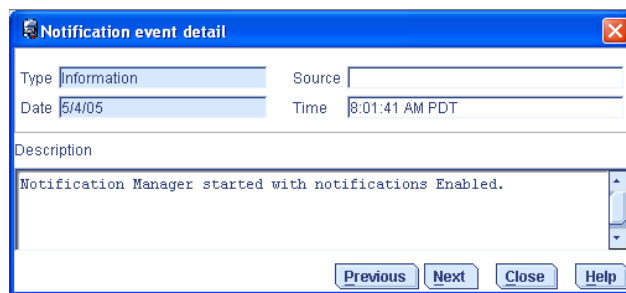

Clearing the Notification Log

To make it easier to monitor recent events, you can clear the Notification Log.

To clear the Notification Log:

- 1 Open the Notification Manager. (See [page 93](#).)
- 2 In the menu bar, click **File**, select **Clear the event log**, then click **Notifications**.

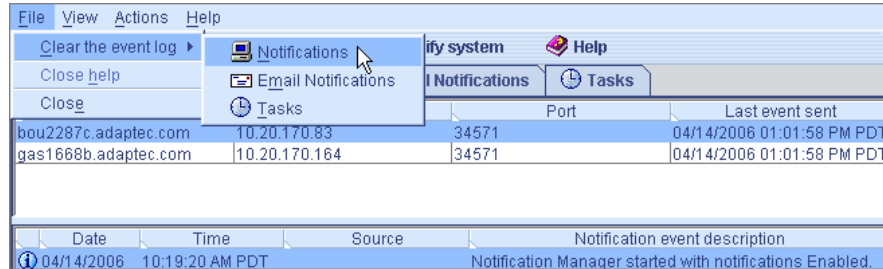

- 3 Click **Yes** to clear the log.

The log is cleared, except for one event reporting that the log was cleared.

Disabling Event Notifications

Event notifications are enabled by default. You can choose to disable them, if required.

Note: If you disable event notifications, events will be generated but not broadcast—not even to the local system.

To disable event notifications:

- 1 Open the Notification Manager. (See [page 93](#).)
- 2 In the menu bar, click **Actions**, then click **Disable notifications**.

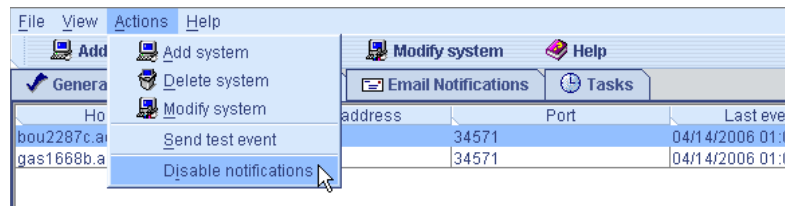

Event notifications are disabled. The Notifications tab (shown at right) shows the red 'disabled' icon.



Re-enabling Event Notifications

To re-enable event notifications, repeat steps 1 and 2 in [Disabling Event Notifications](#), selecting **Enable Notifications** during [Step 2](#).

Setting Up Email Notifications

Email notifications are email messages about events on a system in your storage space that are sent to specified users. Email notifications can help you monitor activity on your entire storage space from any location, and are especially useful in storage spaces that include multiple systems running the Adaptec Storage Manager Agent only.

Only the users you specify receive email notifications. (See [page 102](#).) You can specify which types of events generate email messages to which recipients to ensure that errors receive immediate attention from the right people.

In the Email Notification Manager, you can add and delete email recipients, and modify the types of email notices they receive, as your requirements change.

Opening the Email Notification Manager

This section describes how to set up email notifications for one system in your storage space. You must complete the tasks in this section for *each* individual system that you'll be monitoring with email notifications.

To set up email notifications:

- 1 Note this information:
 - The address of your Simple Mail Transfer Protocol (SMTP) server (host name and domain, or TCP/IP address)
 - The name and email address of each person who will receive email notifications
- 2 In the tool bar, click **Configure**, select the system you want, then click **Email Notifications**.



The Email Notification Manager opens on the Email Notifications tab of a new window.

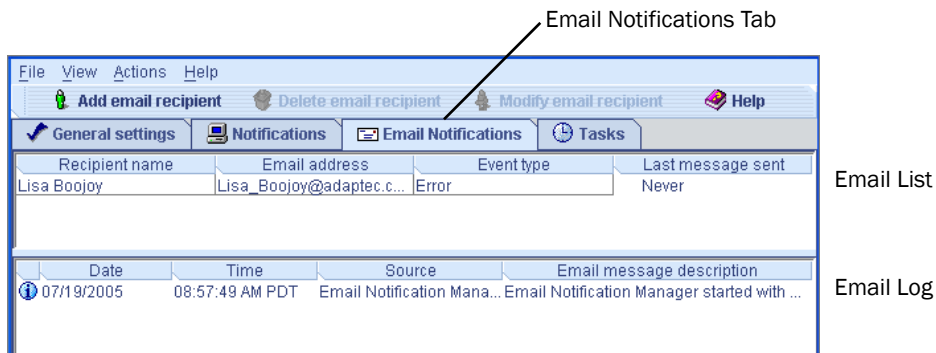

- 3 If this is the first time you are opening the Email Notification Manager, continue with [Entering the SMTP Server Settings on page 100](#).

To set up email notifications, continue with [Adding an Email Recipient on page 100](#).

Entering the SMTP Server Settings

The first time you are opening the Email Notification Manager, the SMTP Server Settings window opens automatically.

In the SMTP Server Settings window:

- 1 Enter the address of your SMTP server.
- 2 Enter the “From” address to appear in email notifications.

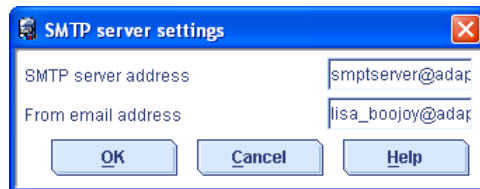

If email recipients will be replying to email notifications, be sure that the “From” address belongs to a system that is actively monitored.

- 3 Click OK to save the settings.
- 4 To set up email notifications, continue with [Adding an Email Recipient](#).

Adding an Email Recipient

To add an email recipient to the Email List:

- 1 Open the Email Notification Manager. (See [page 99](#).)
- 2 In the tool bar, click **Add email recipient**.
- 3 In the Add Email Recipient window (shown in the next Step), enter the recipient’s name and email address.
- 4 In the **Event Type** drop-down menu, select an event level. (For more information on event levels, see [page 92](#).)

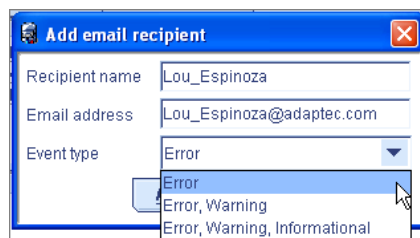

- 5 Click **Add**.
- 6 Repeat Steps 3 to 5 to add more email recipients.

- Click **Cancel** to close the Add Email Recipient window.

The email recipients you added appear in the Email List.

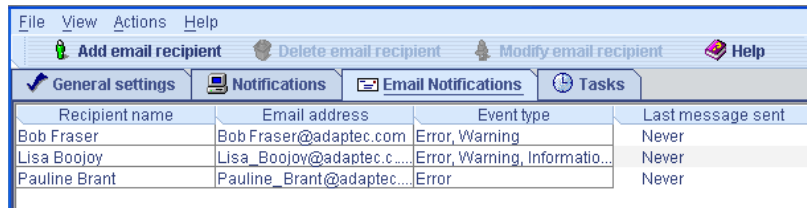

Recipient name	Email address	Event type	Last message sent
Bob Fraser	Bob.Fraser@adaptec.com	Error, Warning	Never
Lisa Boojoy	Lisa_Boojoy@adaptec.c...	Error, Warning, Informatio...	Never
Pauline Brant	Pauline_Brant@adaptec...	Error	Never

Although you can't sort the list, you can reorganize the columns by clicking and dragging the column heads (see the figure on [page 95](#)).

- Close the Email Notifications window when you're done.

Note: You can access other utilities in this window, such as the Task Manager (see [Managing Tasks on page 109](#)), by clicking their tabs.

- Repeat Steps 1 to 8 for each system you want to monitor with email notifications.

Sending a Test Message

To ensure that an email recipient is receiving event notifications, you can send them a test message.

To send a test message:

- Open the Email Notification Manager. (See [page 99](#).)

Note: You can also access the Notification Manager from the menu bar by selecting **Actions > Agent actions > Configure > Email Notifications** tab.

- Click on the email address you want to send the test message to.

Note: You can only send a test message to one email address at a time.

- On the menu bar, select **Actions**, then click **Send test message**.

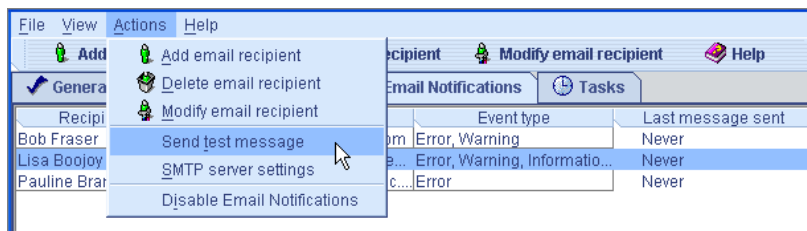

The test message is sent.

If the test is successful, the email recipient receives the test message. If the test fails:

- Ensure that the recipient's email address is correct. (See [Modifying a Recipient's Information on page 102](#) to modify the address.)
- Ensure that your SMTP server address is correct. (See [Changing the Email Notification Manager Settings on page 104](#) to modify the address.)
- Try sending the test message again.

Managing the Email List

This section describes how to:

- Add an email recipient, see [page 100](#).
- Modify an email recipient's information, see the following section.
- Remove an email recipient, see [page 102](#).

Modifying a Recipient's Information

If a recipient's email address changes, or if you need to change the types of event notifications the recipient receives, you can update the recipient's information in the Email List.

To modify a recipient's information:

- 1 Open the Email Notification Manager. (See [page 99](#).)
- 2 Click on the recipient's name.
- 3 Modify the recipient's information as required, then click **OK**.

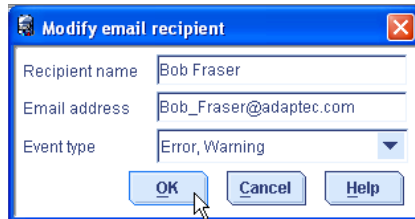

Removing a Recipient from the Email List

You can remove any recipient from the Email List. Once a recipient has been removed, event notifications from the local system are no longer sent to that email address.

To remove a recipient from the Email List:

- 1 Open the Email Notification Manager. (See [page 99](#).)
- 2 Click on the recipient you want to remove.
- 3 In the tool bar, click **Delete email recipient**.
- 4 Click **Yes** to confirm the deletion.

The recipient is removed from the Email List.

Monitoring and Managing the Email Log

The Email Log displays status information and messages about the Email Notification Manager itself, such as whether email notifications were sent successfully or not.

This section explains how to use and clear the Email Log.

Using the Email Log

By default, email events are listed in the order they occurred, with the most recent event first. To make it easier to find a specific event, click on the column heads to sort events. You can also reorganize the column by clicking and dragging the column heads (see the figure on [page 95](#)).

Double-click on an event to see basic information about the event, including the event type. (See [page 92](#) for a list of event types.) Click **Next** to see the next event in the list.

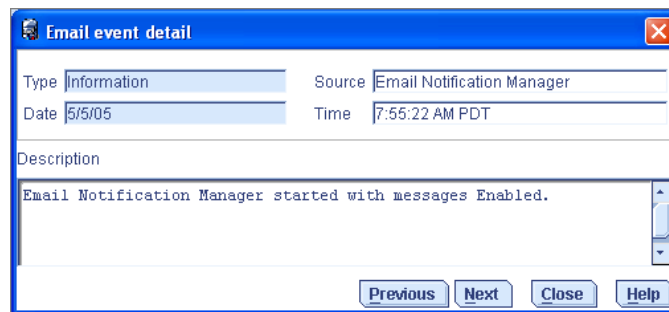

Clearing the Email Log

To make it easier to monitor recent events, you can clear the Email Log.

To clear the Email Log:

- 1 Open the Email Notification Manager. (See [page 99](#).)
- 2 In the menu bar, select **Clear the event log**, then click **Email Notifications**.

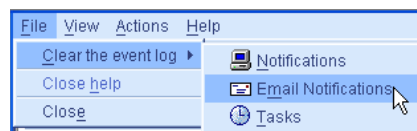

- 3 Click **Yes** to clear the log.

The log is cleared, except for one event reporting that the log was cleared.

Changing the Email Notification Manager Settings

You can modify these Email Notification Manager settings as your needs change:

- Address of your SMTP server
- ‘From’ address that will appear in email notifications

To modify the Email Notification Manager settings:

- 1 Open the Email Notification Manager. (See [page 99](#).)
- 2 In the menu bar, select **Actions**, then click **SMTP server settings**.

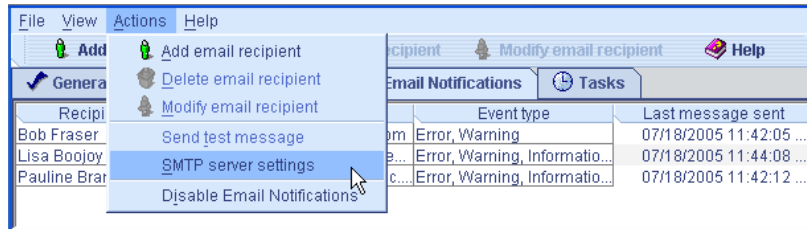

The SMTP Server Settings window opens.

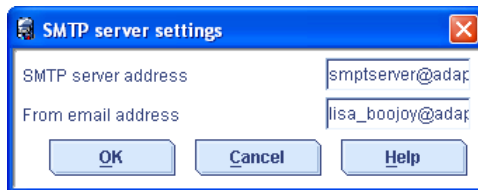

- 3 Enter the address of your SMTP server.
- 4 Enter the “From” address to appear in email notifications.

If email recipients will be replying to email notifications, be sure that the “From” address belongs to a system that is actively monitored.

- 5 Click **OK** to save the settings.

Disabling Email Notifications

Email notifications are enabled by default, but can be disabled, if required.

Note: If you disable email notifications, events will be generated but email notices won't be broadcast.

To disable email notifications:

- 1 Open the Email Notification Manager. (See [page 99](#).)
- 2 In the menu bar, click **Actions**, then click **Disable Email Notifications**.

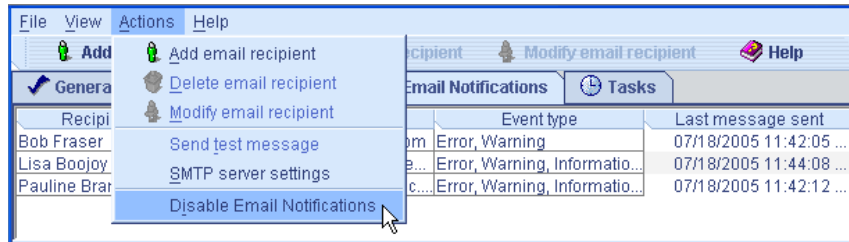

Email notifications are disabled. The Email Notifications tab (shown at right) shows the red 'disabled' icon.



Re-enabling Email Notifications

To re-enable email notifications, repeat steps 1 and 2 in *Disabling Email Notifications*, selecting **Enable Notifications** during [Step 2](#).

Broadcasting Event Alerts to Users

You can set the Adaptec Storage Manager Agent to send event alerts about a *specific* system to all users who are logged into your storage space. You might want to do this if your storage space isn't managed by a dedicated person, or if that particular system is off-site or not connected to a monitor. Event alerts signal everyone working on the storage space that a system requires technical assistance.

When you set Adaptec Storage Manager to broadcast event alerts, *all* logged-in users receive messages about *all* types of events. In Windows, these alerts appear as pop-up messages; in all other operating systems, these alerts appear as console messages.

When enabled, event alerts occur independent of event notifications (see [page 93](#)) and email notifications (see [page 99](#)).

To enable event alerts:

- 1 On the tool bar, click the **Configure** button, select the system you want, then click **General Settings**.

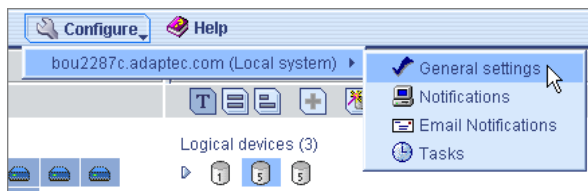

The Adaptec Storage Manager Agent General Settings window opens for that system. (See the figure on [page 64](#).)

- 2 Select **Broadcast events to logged-in users**, then click **Save changes**.
- 3 Restart Adaptec Storage Manager to apply the change.

Managing Enclosure Status

If your storage space includes an enclosure with an enclosure management device, such as a SCSI Accessed Fault-Tolerant Enclosure (SAF-TE) processor, Adaptec Storage Manager also displays temperature, fan, and power module status in the Physical Device view, as shown in the next figure.

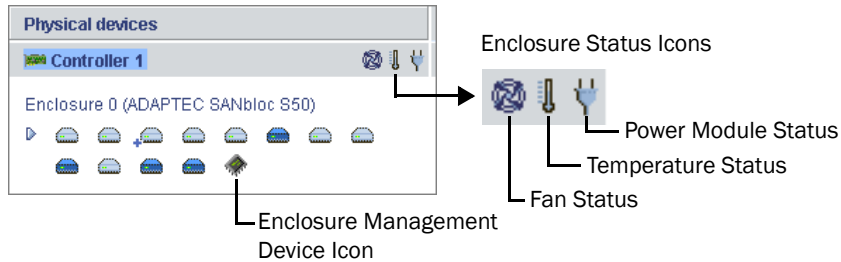

The enclosure status icons change color to indicate status:

	Icon	Status	Examples
Enclosure Fans		Normal	Fans are working properly.
		Warning	A fan has failed.
		Error	Multiple fans have failed.
Enclosure Temperature		Normal	Enclosure temperature is normal.
		Warning	Enclosure temperature is higher than normal.
		Error	Enclosure is overheating.
Enclosure Power		Normal	Power supplies are working normally.
		Warning	One power supply has failed.
		Error	Multiple power supplies have failed.

Note: If your enclosure does not have an enclosure management device, the status icons appear but *do not* indicate status.

Silencing and Testing the Audible Alarm

Adaptec Storage Manager supports an audible alarm which is triggered on the local system when a Warning- or Error-level event (see [page 91](#)) occurs on any system in the Enterprise View. The alarm is a series of beeps, which sound every five minutes until the event is resolved.

The alarm is disabled by default, but can be enabled on any system. You can also change the frequency and duration of the alarm (see [Changing a System's Audible Alarm Settings on page 64](#) for more information).

This section describes how to:

- Enable a system's alarm (see the following section).
- Ensure the alarm is working on your local system (see [page 108](#)).
- Silence a sounding alarm (see [page 108](#)).

Enabling a System's Alarm

You can enable the alarm for a selected system, if required.

- 1 In the Enterprise View, select the system you want.
- 2 In the menu bar, click **Actions**, select **Agent Actions**, select **Alarm Actions**, then click **Enable**.

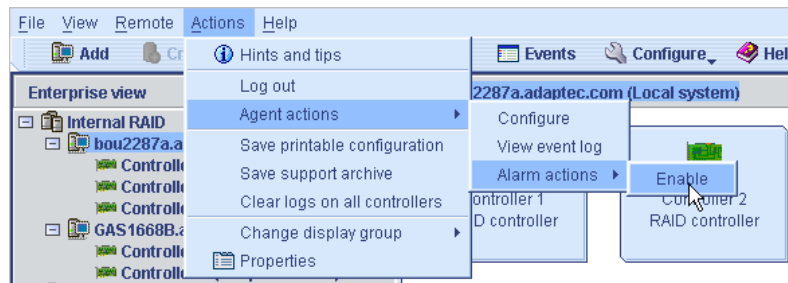

The alarm is enabled for that system.

To disable an alarm, repeat Steps 1 and 2, selecting the alarm action **Disable**.

⚠ Caution: When the alarm is disabled, no audible signal sounds when a Warning- or Error-level event occurs on the system.

Testing the Alarm

To test the audible alarm to ensure that it's working on your local system:

- 1 Ensure that the speakers on your local system aren't muted.
- 2 In the Enterprise View, click on your local system.
- 3 In the menu bar, click **Actions**, then select **Agent actions**.

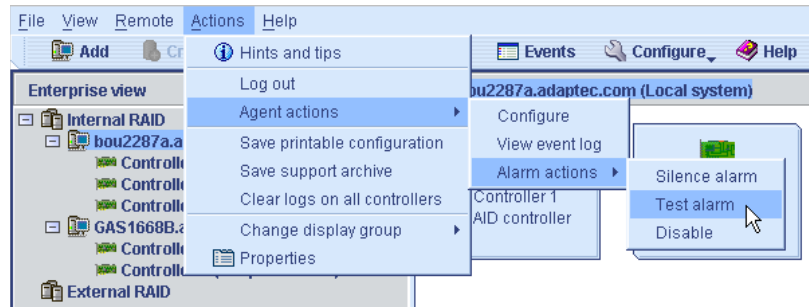

- 4 Select **Alarm actions**, then click **Test alarm**.

The alarm sounds.

- 5 To stop the test, click **OK**.

Silencing the Alarm

When a Warning- or Error-level event occurs, you can silence the alarm on your local system while you fix the problem.

To silence the alarm, click the **Silence** button (shown at right) in the main Adaptec Storage Manager window.



Alternatively, in the menu bar, click **Actions**, then select **Agent actions**. Select **Alarm actions**, then click **Test alarm**.

Managing Tasks

9

In this chapter...

Scheduling a Task	110
Opening the Task Manager	111
Monitoring Tasks.....	112
Modifying a Task	113
Deleting a Task.....	114
Disabling the Task Manager.....	114

Adaptec Storage Manager allows you to schedule some types of jobs (or *tasks*) to complete at convenient times. Additionally, you can schedule some tasks to recur at preset times.

A Task Manager utility helps you manage the tasks you schedule.

This chapter describes how to schedule, monitor, and manage tasks.

Scheduling a Task

If a task is lengthy and limits access to components on your storage space, you may want to set a date and time for the task to complete, instead of running the task while there is activity on your storage space.

If a task must be performed regularly, you can schedule it to recur at preset times.

You can schedule these Adaptec Storage Manager tasks:

- Expanding a logical drive
- Changing a logical drive's RAID level
- Modifying the stripe size of a logical drive
- Verifying a logical drive
- Verifying and fixing a logical drive

To schedule one of these tasks:

- 1 Complete each step of the task until you are prompted to click **Apply**. (*Don't click Apply.*)

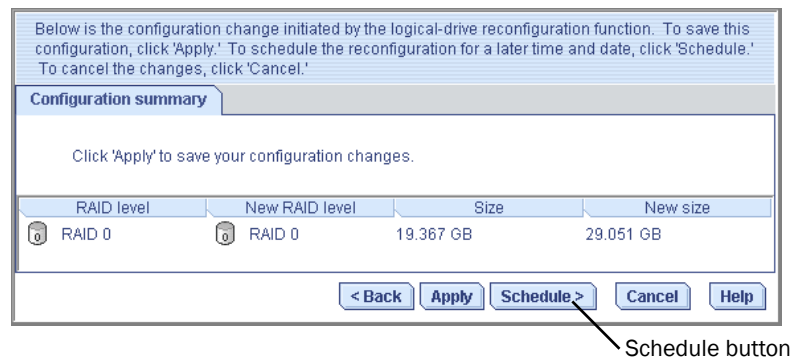

- 2 Click **Schedule**.

The schedule window opens. (The window you see may be different from the one shown in this example, depending on which type of task you are scheduling.)

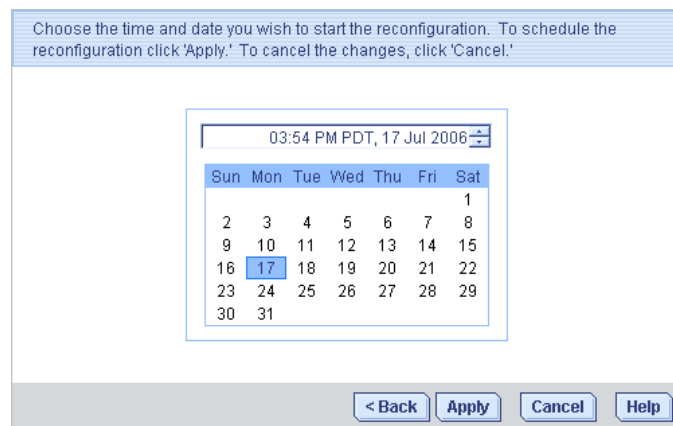

- 3 Set the date and time for the task.

Note: Keep geography in mind—If you are scheduling tasks on remote systems located in other geographical areas, remember that the time you set for a scheduled task is *that system's* time, which may be different from local time. You will be prompted to select a new time if the one you've set occurs in the past on the remote system.

- 4 Set the recurrence frequency, if the option is available for this task and you want it to occur regularly.
- 5 Click **Apply**.

The task is saved in the Task Manager, and the scheduled task is added to the Task List. For more information about the Task Manager, see the following section.

Opening the Task Manager

You can use the Task Manager to monitor and modify the tasks you have scheduled. (To schedule a task, see [page 110](#).)

Tasks are associated with systems. When you open the Task Manager, you see the scheduled tasks associated with that local or remote system only.

To open the Task Manager, in the tool bar, click **Configure**, select the system you want, then click **Tasks**.



The Task Manager opens on the Tasks tab of a new window. The Tasks tab has two main panels, as shown in this figure:

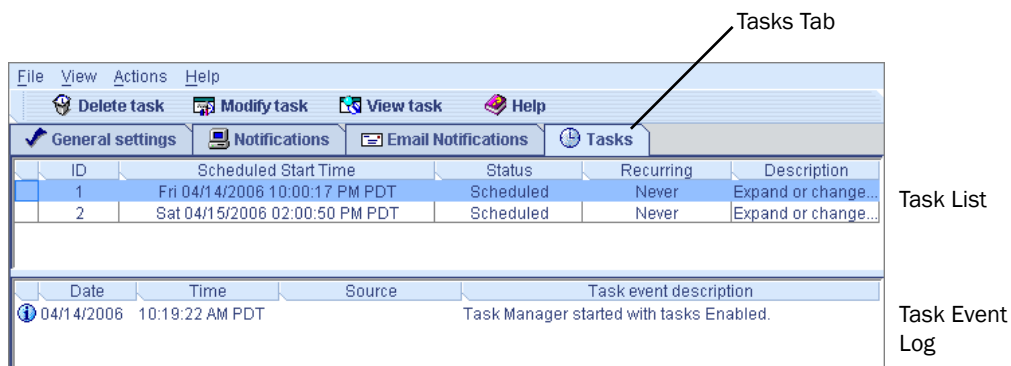

Note: From the Tasks tab, you can access other utilities in this window, such as the Email Notification Manager (see [page 99](#)), by clicking their tabs.

Monitoring Tasks

Use the two main panels of the Task Manager—the Task List and the Task Event Log—to monitor your tasks.

Monitoring Upcoming Tasks in the Task List

The Task List displays all scheduled tasks in order of creation, and includes basic information about each task. Although you can't sort the tasks in any other order, you can reorganize the columns in the Task List by clicking and dragging the column heads (see the figure on [page 95](#)).

The Status column of the Task List shows the current condition of each task:

- **Scheduled**—The task is scheduled to be completed at a future date and time.
- **Executed**—The task has been completed successfully.
- **Executed***—A recurring task has been completed once and will be repeated at the scheduled time.
- **Error**—The task has not been completed successfully. (For more information about an error, double-click the task in the Task List to open the Task Properties window.)



In the menu bar, click **View task** for additional detail about any task in the Task List.

Checking Past Tasks and Events in the Event Log

The Event Log displays detailed information about the Task Manager itself, such as when scheduled events were modified, deleted, or completed successfully.

By default, task events are listed in the order they occurred, with the most recent event first. To make it easier to find a specific event, click on the column heads to sort task events. You can also reorganize the columns by clicking and dragging the column heads (see the figure on [page 95](#)).

The Event Log uses icons to show the status of past tasks:

Icon	Status	Explanation and Solution
	Information	The task or event completed successfully. No action required.
	Warning	The task missed its start time. Reschedule the task to clear the error, as described in Modifying a Task on page 113 .
	Error	The task failed. Delete the task to clear the error. Schedule the task again, as described in Scheduling a Task on page 110 .)

Double-click on an event to see basic information about the event. Click **Next** to see the next event in the list.

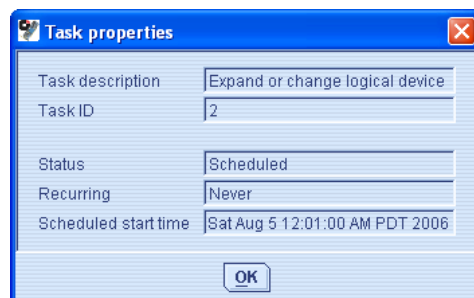

Modifying a Task

If your requirements change, you can reschedule a task to a different date or time. You can also modify the task description that appears in the Task List. Creating a custom task description makes it easier to find the task in the Task List.

To modify a scheduled task:

- 1 In the tool bar, click **Configure**, select the system you want, then click **Tasks** (as shown on page 111).
- 2 In the Task Manager, select the task you want to change, then click **Modify task**.

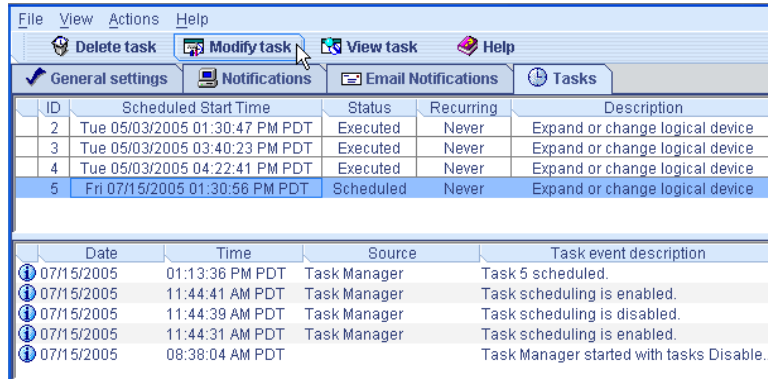

- 3 In the Modify Task window, make the required changes, then click **OK**.

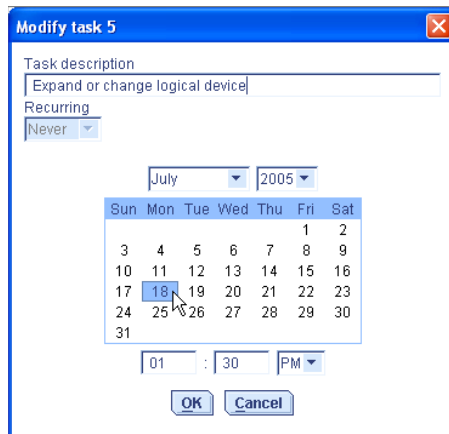

The task and Task List are updated with the new information.

What if a task misses its start time?

Tasks scheduled in Adaptec Storage Manager include an automatic 30-minute grace period following their start time, to accommodate temporary interruptions. For instance, if there's a brief power outage a task will run once normal conditions resume, if the interruption lasts no longer than 30 minutes past the scheduled start time.

If a task misses its start time, it must be rescheduled. For instructions, see [Modifying a Task](#).

If a recurring task misses its start time, it is automatically rescheduled to run at the next scheduled interval.

Deleting a Task

If a scheduled task is no longer required, you can delete it from the Task Manager.

To delete a task:

- 1 In the tool bar, click **Configure**, select the system associated with the task you want to delete, then click **Tasks** (as shown on [page 111](#)).
- 2 In the Task Manager, select the task you want to delete, then click **Delete task**.

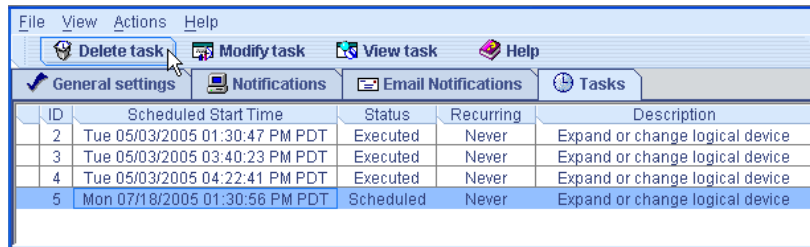

- 3 Click **Yes** to confirm the deletion.

The task is deleted.

Disabling the Task Manager

The Task Manager is enabled by default. If you do not wish to schedule tasks on a selected system, you can disable it.

Note: If you disable the Task Manager, no scheduled tasks will run on that system.

To disable the Task Manager:

- 1 In the tool bar, click **Configure**, select the system whose Task Manager you want to disable, then click **Tasks** (as shown on [page 111](#)).
- 2 In the menu bar, click **Actions**, then click **Disable Task Scheduler**.

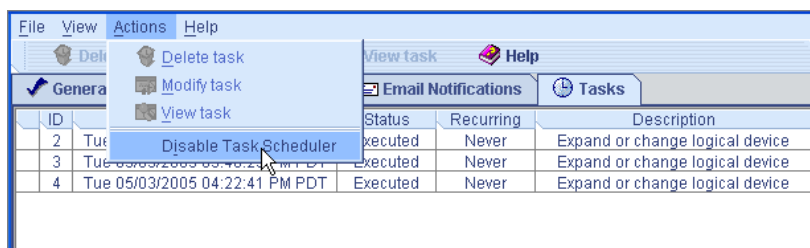

The Task Manager is disabled. The Tasks tab (shown at right) shows the red 'disabled' icon.



Note: When the Task Manager is disabled, a brief three-tone alert sounds each time you open and log in to Adaptec Storage Manager. Scheduled tasks in the Task List will not run while the Task Manager is disabled.

Re-enabling the Task Manager

To re-enable the Task Manager, repeat the steps in *Disabling the Task Manager* on page 114, selecting **Enable Task Scheduler** during [Step 2](#).

Scheduled tasks that have missed their start times must be rescheduled if you want them to run. See *Modifying a Task* on page 113 for instructions.

Scheduled tasks that did not miss their start time while the Task Manager was disabled will run as scheduled.

Working with Display Groups

10

In this chapter...

Adding a System to a Display Group.....	117
Viewing Display Group Status.....	117
Moving a System from One Display Group to Another.....	118
Renaming a Display Group.....	118
Removing a System from a Display Group	119
Deleting a Display Group.....	119

This chapter describes how to work with and manage display groups in Adaptec Storage Manager.

To create display groups, see *Creating Display Groups* on page 60.

Adding a System to a Display Group

As your storage space grows and changes, you can add new systems to your display groups.

To add a system to a display group:

- 1 Right-click on the system in the Enterprise View.
- 2 Select **Change display group**, then click the display group name (or click **New group**).

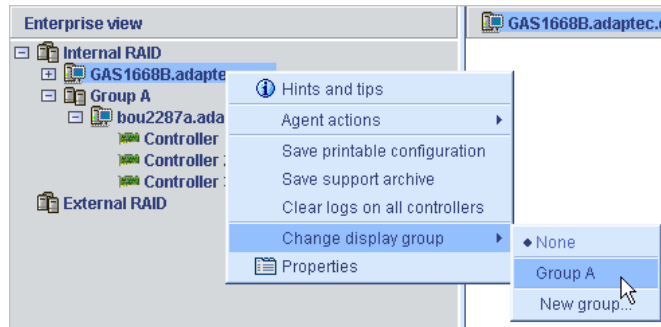

The system is added to the display group.

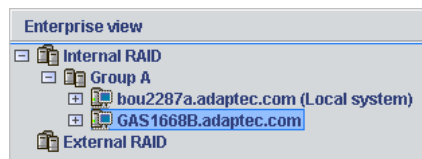

Note: A system can belong to only one display group at a time; you can't include the same system in multiple display groups.

Viewing Display Group Status

To quickly view the status of systems within a display group, you can open the display group Properties window.

In the Enterprise View, right-click on the display group, then click **Properties**. The Properties window opens for that display group, summarizing the status of the systems that belong to that group.

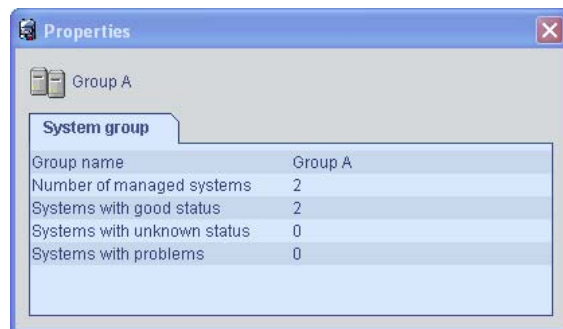

Moving a System from One Display Group to Another

To move a system from one display group to another:

- 1 In the Enterprise View, right-click the system you want to move.
- 2 Select **Change display group**, then click the name of the display group you want.

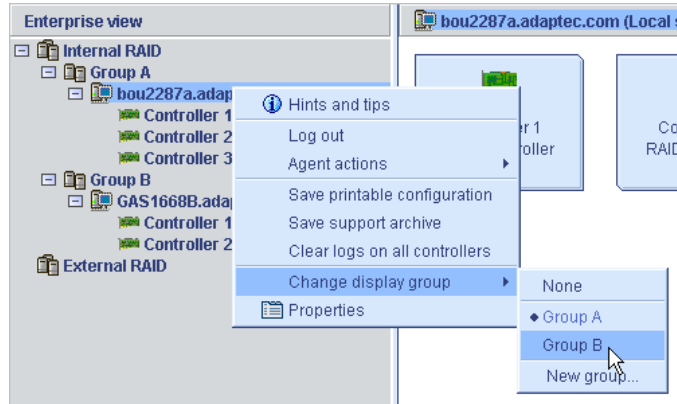

The system moves to its new display group.

Renaming a Display Group

You can make managing your storage space easier and more efficient by giving your display groups meaningful names. To rename a display group:

- 1 In the Enterprise View, right-click on the display group, then click **Rename display group**.

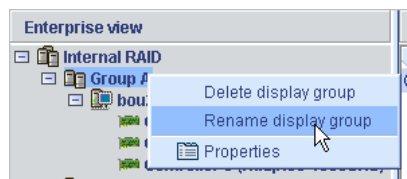

- 2 Enter a new name for the display group, then click **OK**.



The Enterprise View shows the new name of the display group.

Removing a System from a Display Group

To remove a system from a display group:

- 1 In the Enterprise View, right-click the system you want to remove.
- 2 Select **Change display group**, then click **None**.

The system is removed from the display group.

Note: Systems that are *not* part of display groups are listed at the top of the Enterprise View, above any display groups.

Deleting a Display Group

If required, you can delete a display group. When you delete the display group, the systems that belonged to it are listed at the top of the Enterprise View, above any remaining display groups.

To delete a display group:

- 1 In the Enterprise View, right-click on the display group.
- 2 Click **Delete display group**.

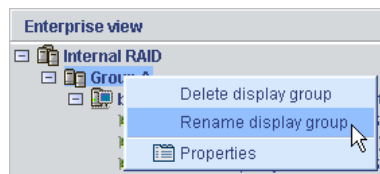

The display group is deleted and the systems that belonged to it are no longer grouped together in the Enterprise View.

Managing Controllers, Disk Drives, and Enclosures

11

In this chapter...

Viewing Component Properties	121
Blinking a Component.....	121
Managing Disk Drives.....	122
Managing Controllers	124
Managing Enclosures	126
Updating Controller BIOS and Firmware.....	128

This chapter describes how to manage the controllers, disk drives, and enclosures in your storage space.

Viewing Component Properties

Click on any component in the main window of Adaptec Storage Manager, then click the **Properties** button (shown at right) to view version numbers, status, model numbers, and other information about that component.



The properties listed vary, depending on which type of component you select. The examples below show the Enclosure (right) and Logical Drive (left) Properties windows.

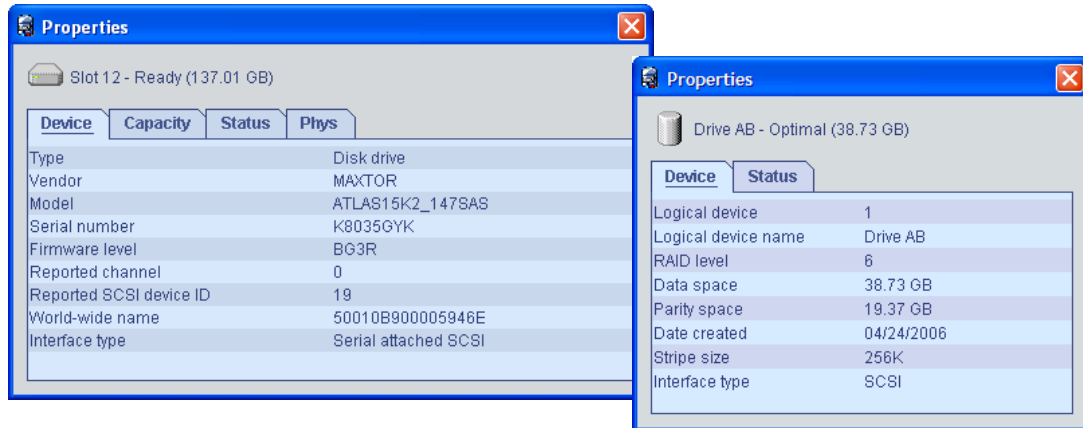

Blinking a Component

You can blink the LEDs on enclosures, or disk drives *inside* enclosures, to identify where they are physically located in your storage space. This table describes how to blink specific enclosures and disk drives.

To Blink...	Right-click...
The disk drive	Disk Drive icon
All disk drives connected to that controller	Controller icon (in the Enterprise View or in the Physical Devices View)
The enclosure	Enclosure Management Device icon
All disk drives included in a logical drive	Logical Drive icon
All disk drives included in all the logical drives on a selected controller	Logical devices Text—In the Logical Devices View of a controller with multiple logical drives
All disk drives connected to selected controller ports	Ports Text—In the Physical Devices View of a controller with multiple ports
All disk drives connected to a selected controller channel	Channel Text—In the Physical Devices View of a controller with multiple channels
All disk drives connected to a selected controller connector	Device Text—In the Physical Devices View of a controller with multiple connectors

To blink a component:

- 1 In Adaptec Storage Manager, right-click the component, then click **Blink...**

Note: If the component you select (for instance, a controller) doesn't support the blink function, the Blink... option won't appear in the menu.

The LEDs on the disk drives or enclosures begin to flash.

- 2 Click OK to stop blinking the component.

Managing Disk Drives

This section describes how to use Adaptec Storage Manager to manage the disk drives that are part of your storage space.

Replacing Disk Drives in a Logical Drive

You can replace one or more disk drives in a logical drive. You may want to do this to upgrade to larger disk drives, or to make disk drive size uniform across the logical drive.

 **Caution:** If another disk drive in the logical drive fails during rebuild (see [page 137](#)), you may lose data.

To replace a disk drive in a logical drive:

- 1 In the Physical Devices View, click the disk drive you want to replace.
- 2 Set the drive state to failed. (See [page 122](#).)
- 3 Remove and replace the disk drive with one of equal or larger size.
- 4 Wait for the logical drive to rebuild. (See [page 137](#).)
- 5 Repeat Steps 1 to 4 for all the disk drives you want to replace.

For help solving disk drive problems, see [Recovering from a Disk Drive Failure on page 135](#).

Setting a Disk Drive to 'Failed'

Before you can remove a disk drive, you should set it to a failed state to protect your data.

 **Caution:** You may lose data or damage your disk drive if you remove a disk drive without first setting it to a failed state.

You can set a disk drive to a failed state if:

- The disk drive is not part of a logical drive, *or*
- The disk drive is part of a redundant, healthy logical drive

You can't set a disk drive to a failed state if doing so will take a logical drive offline.

To set a disk drive to a failed state:

- 1 In the Physical Devices View, click the disk drive.
- 2 In the menu bar, select **Actions**, then click **Set drive state to failed**.
- 3 Click **Yes** to set the drive status to failed.
- 4 Remove and replace the disk drive.
- 5 If the logical drive that the disk drive belongs to is failed, see [Recovering from a Disk Drive Failure on page 135](#).

Initializing Disk Drives

You can use Adaptec Storage Manager to initialize any disk drives that are in a Ready state, if required. You may want to do this to erase all existing data and metadata (including all logical drive information).

- ⚠ Caution:** Do not initialize a disk drive that is part of a logical drive. Initializing a disk drive that's part of a logical drive may make the logical drive unusable. Back up all data from your disk drive before you initialize it.

To initialize a single disk drive:

- 1 In the Physical Devices view, click the disk drive you want to initialize.
- 2 In the menu bar, select **Actions**, then click **Initialize**.

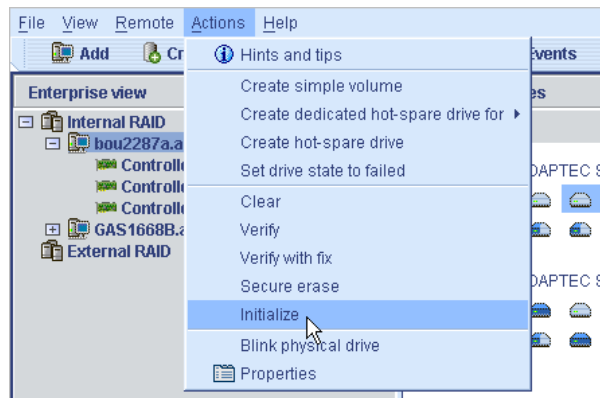

- 3 Click **Yes** to initialize the disk drive.

The initialization begins.

To initialize *all* ready disk drives on a controller:

- 1 In the Enterprise View, click the controller whose disk drives you want to initialize.
- 2 In the menu bar, select **Actions**, then click **Initialize all ready drives**.

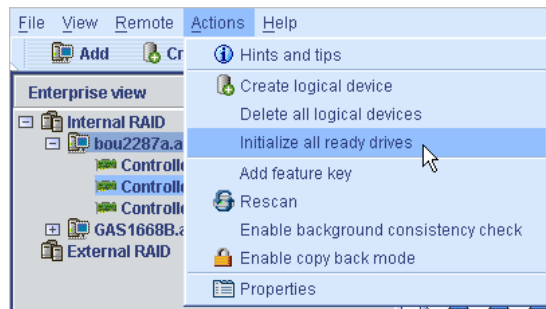

- 3 Click **Yes** to initialize the disk drives.

The initialization begins.

Managing Controllers

This section describes how to use Adaptec Storage Manager to manage the controllers that are part of your storage space:

- To register a new controller, see the following section.
- To test a controller alarm, see this page.
- To silence a controller alarm, see [page 125](#).
- To disable a controller alarm, see [page 125](#).
- To rescan a controller, see [page 125](#).
- To save your controller configuration, see [page 126](#).

Registering New Controllers

When you log in to Adaptec Storage Manager, it searches for new controllers in your storage space. If it detects a new controller, you are prompted to register it.

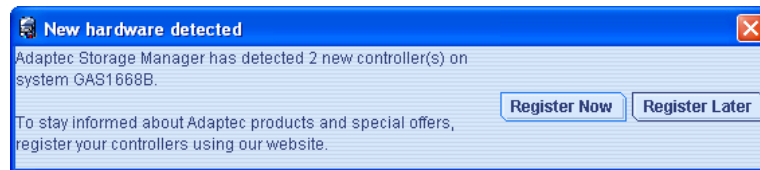

To stay informed about Adaptec products and special offers, register your controllers by clicking **Register Now**.

Follow the on-screen instructions to complete the registration.

Testing a Controller Alarm

Note: Not all controllers have alarms. Refer to your controller's documentation for more information.

To test a controller alarm to ensure that it's working:

- 1 Ensure that the speakers on your local system aren't muted.
- 2 In the Enterprise View, select the controller you want.
- 3 In the menu bar, click **Actions**, select **Alarm actions**, then click **Test alarm**.

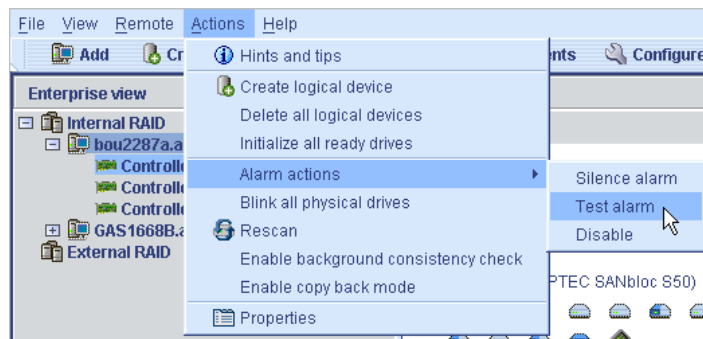

The alarm sounds.

- 4 To stop the test, click **OK**.

Silencing a Controller Alarm

You can silence the alarm on a controller while you fix the problem.

To silence the alarm, click the **Silence** button (shown at right) in the main Adaptec Storage Manager window.



Disabling a Controller Alarm

You can disable the alarm for a selected controller, if required.

⚠ Caution: If you disable the alarm, no audible signal will sound when an error occurs on the controller.

To disable a controller's alarm:

- 1 In the Enterprise View, select the controller you want.
- 2 In the menu bar, click **Actions**, select **Agent Actions**, select **Alarm Actions**, then click **Disable** (shown in the figure in [Step 3](#) of the previous section).

The alarm is disabled for that system.

Rescanning a Controller

After you connect a disk drive to or remove a 'Ready' (non-failed) disk drive from a controller, Adaptec Storage Manager may not recognize the change until it rescans the controller.

To rescan a controller:

- 1 In the Enterprise View, click the controller.
- 2 In the menu bar, select **Actions**, then click **Rescan**.

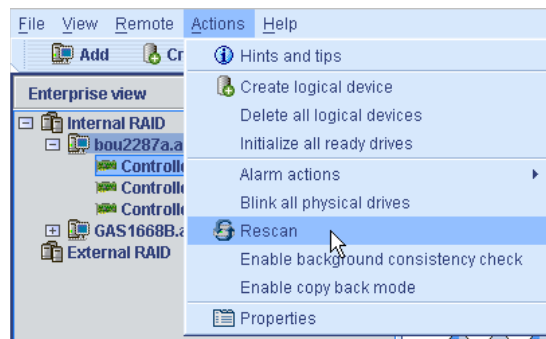

Adaptec Storage Manager scans all the channels or ports on the controller you selected.

When the scan is complete, a report appears.

- 3 Click **Done** after you have reviewed the scan report.

Saving Your Controller Configuration

If you require a record of your controller configurations, you can use Adaptec Storage Manager to create a text file with this information about all controllers on a selected system:

- Controllers
- Disk drives
- Disk drives used in logical drives
- Logical drives

To save a system's controller configurations:

- 1 In the Enterprise View, click the local or remote system.
- 2 In the menu bar, select **Actions**, then click **Save printable configuration**.

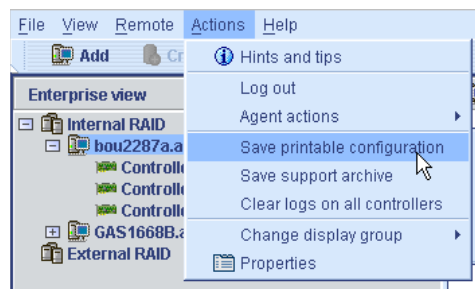

- 3 In the Save window, browse to the directory you want, then enter a file name for the report. (The default directory is the directory in which the Adaptec Storage Manager is installed. The default file name is RaidCfg.log.)

A text-file report is saved.

Managing Enclosures

This section describes how to manage the enclosures in your storage space by:

- Testing an enclosure alarm (see the following section).
- Silencing an enclosure alarm (see [page 127](#)).
- Disabling an enclosure alarm (see [page 127](#)).

Testing an Enclosure Alarm

To test a controller alarm to ensure that it's working:

- 1 Ensure that the speakers on your local system aren't muted.
- 2 In the Enterprise View, select the controller that's connected to the enclosure you want.
- 3 In the Physical Devices View, right-click the enclosure icon (shown at right) of the enclosure that you want.



- 4 Select **Alarm actions**, then click **Test alarm**.

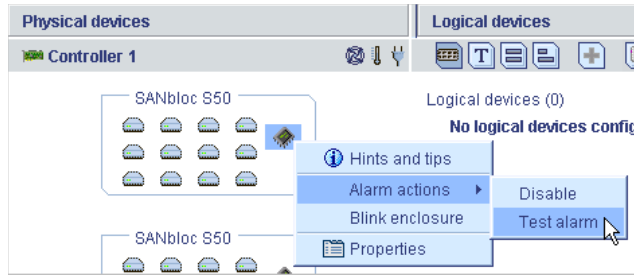

The alarm sounds.

- 5 To stop the test, click **OK**.

Silencing an Enclosure Alarm

You can silence the alarm on an enclosure while you fix the problem.

To silence the alarm, click the **Silence** button (shown at right) in the main Adaptec Storage Manager window.



Disabling an Enclosure Alarm

You can disable the alarm for a selected enclosure, if required.

⚠ Caution: If you disable the alarm, no audible signal will sound when an error occurs on the enclosure.

To disable an enclosure's alarm:

- 1 In the Enterprise View, select the controller that's connected to the enclosure you want.
- 2 In the Physical Devices View, right-click the enclosure icon (shown at right) of the enclosure that you want.
- 3 Select **Alarm actions**, then click **Disable**.

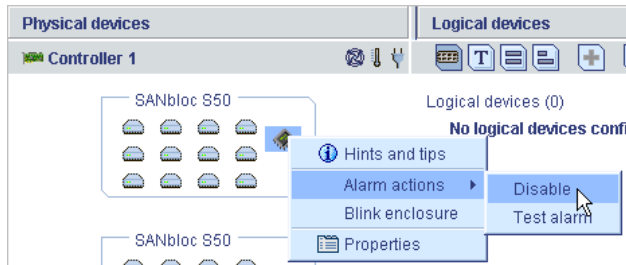

The alarm is disabled for that system.

Updating Controller BIOS and Firmware

Note: This task is recommended for advanced users only.

Adaptec Storage Manager provides a wizard to help you update the BIOS and firmware for the controllers in your storage space. The ROM Update wizard updates the BIOS and firmware for all controllers of the same type on local and remote systems. You can update one type of controller at a time.

Before You Begin

Before you begin, download the latest firmware images from the Adaptec Web site at www.adaptec.com. Image files typically come in sets of two or more and have a .ufi file extension.

Updating the Controller BIOS and Firmware

To update the controller firmware:

- 1 In the Enterprise View, right-click **Direct attached storage**, then click **Update controller images**.

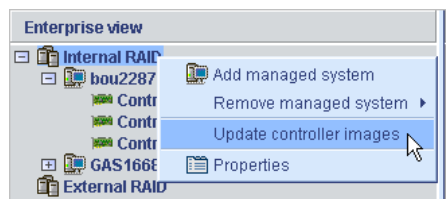

The ROM Update wizard opens.

- 2 Click **Next**.
- 3 Click **Add** to browse to the firmware image files you downloaded, select the files, then click **Open**.

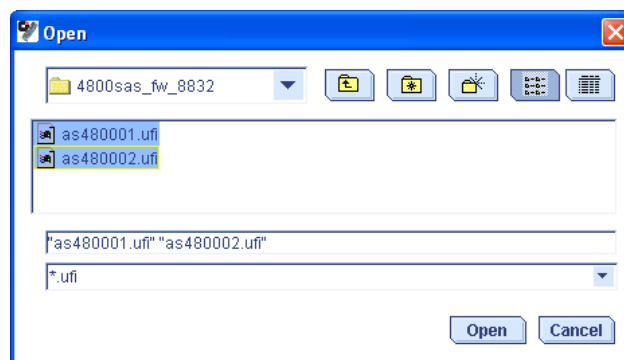

- 4 In the wizard, select the image files you want, then click Next.

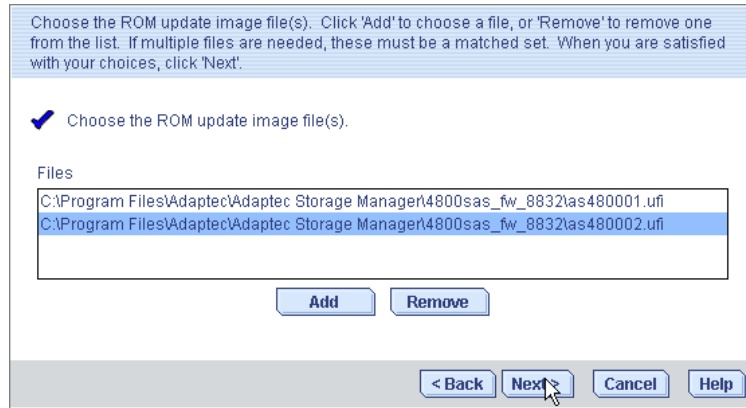

- 5 Select the controllers you want to update, then click Next.

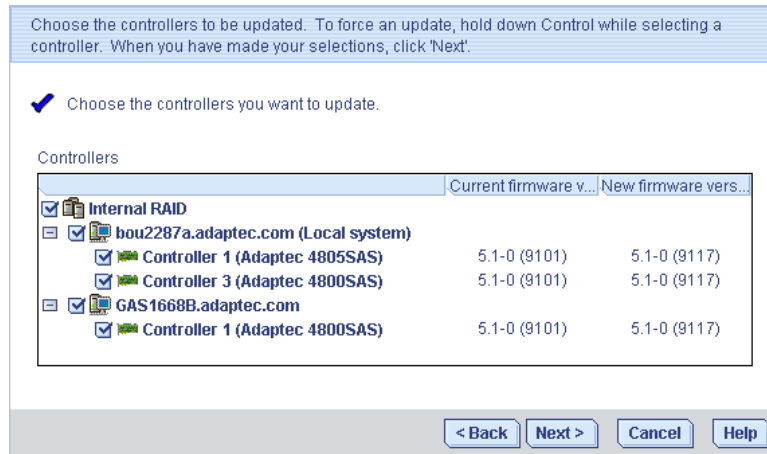

- 6 Review the update summary, then click Apply.

- 7 When prompted, click Yes to begin the update.

 **Caution:** Do not power down the controller(s) during the update.

- 8 When the update is complete, click OK. Then, restart the server(s) to activate the new firmware images.

Configuring SNMP Support

12

In this chapter...

Configuring SNMP Support on Windows.....	131
Configuring SNMP Support on Linux.....	132
Configuring SNMP Support on NetWare.....	132

This appendix describes how to configure SNMP support for the Adaptec Storage Manager software. Adaptec Storage Manager supports SNMP “gets” and “traps” through the use of an SNMP agent.

Configuring SNMP Support on Windows

Note: Be sure your Windows installation includes SNMP support. By default, Windows 2000 and Windows XP do not install SNMP.

To install and configure SNMP support:

- 1 Run the Adaptec Storage Manager installation program (see [page 23](#)).
SNMP support is installed automatically, unless you choose to *not* install it.
- 2 Follow the on-screen instructions to complete the installation, then restart your system.
- 3 Open the Windows Computer Management tool, then select **Services** from the tree.

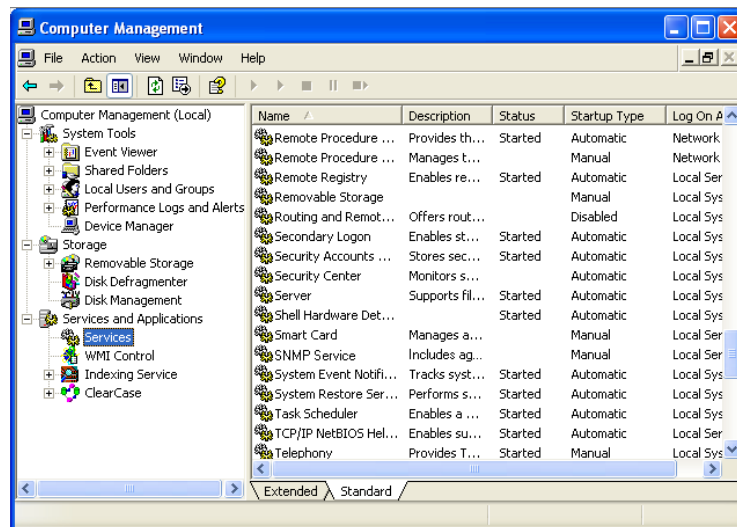

- 4 Double-click **SNMP Service**.
The SNMP Service Properties window opens.
- 5 Click the **Traps** tab, then enter the IP address of each system on which you want to enable traps.
- 6 Click **OK**.
- 7 Start the SNMP service.

Configuring SNMP Support on Linux

For the Linux operating system, the Adaptec Storage Manager SNMP agent is a sub-agent that interfaces with the UCD-SNMP agentx architecture. UCD-SNMP is a third-party package for Linux; for information, documentation, and downloads, see www.net-snmp.org.

To configure SNMP support:

- 1 Install Adaptec Storage Manager (see [page 23](#)).
- 2 Add Adaptec OID information and agentx extension information to the `snmp.conf`.
- 3 Delete `/var/agentx/master` (socket file for agentx).
- 4 Start the `snmpd` daemon and `agentx`.
- 5 Start `aus-snmp` daemon.

Refer to your Linux documentation for information on configuring UCD-SNMP, agentx, and setting up traps.

Configuring SNMP Support on NetWare

To install Adaptec Storage Manager SNMP support, at the command prompt type this command, then press **Enter**:

```
load AUSSNMP.NLM
```

Refer to your NetWare documentation for information on configuring traps.

Solving Problems

13

In this chapter...

Troubleshooting Adaptec Storage Manager	134
Identifying a Failed or Failing Component.....	134
Recovering from a Disk Drive Failure	135
Rebuilding Logical Drives.....	137
Solving Notification Problems.....	138
Creating a Support Archive File.....	138
Understanding Error and Warning Messages	139

Troubleshooting Adaptec Storage Manager

If you experience problems installing or using Adaptec Storage Manager, follow these suggestions:

- Ensure that you are logged in to Adaptec Storage Manager at the permission level you need to perform the tasks you want. (See [page 32](#) for more information.)
- Ensure that all managed systems are powered on and that you are logged in to any remote systems you want to manage. (See [page 32](#) for more information.)
- Check all cable connections.
- Try uninstalling and reinstalling Adaptec Storage Manager.

Identifying a Failed or Failing Component

When you are notified of a Warning- or Error-level event, use Adaptec Storage Manager's rapid fault isolation feature to quickly identify the source of the problem.

For instance, in this example, a disk drive has failed. To find the failed disk drive, follow the yellow Error icons:

Enterprise view

- Internal RAID
 - bou2287a.adaptec.com (Local system)
 - GAS1668B.adaptec.com — Error is on a remote system...
 - External RAID

Enterprise view

- Internal RAID
 - bou2287a.adaptec.com (Local system)
 - GAS1668B.adaptec.com
 - Controller 1 (Adaptec 4800SAS)
 - Controller 2 (Adaptec 2230S) — ...on Controller 2...
 - External RAID

Enterprise view

- Internal RAID
 - bou2287a.adaptec.com (Local system)
 - GAS1668B.adaptec.com
 - Controller 1 (Adaptec 4800SAS)
 - Controller 2 (Adaptec 2230S)
 - External RAID

Physical devices

- Controller 2 (Adaptec 2230S)
 - Channel 0 (14 devices found)
 - Channel 1 (14 devices found)

Logical devices

- Logical devices (2)
 - Device 1 - Optimal (9.684 GB)
 - Device 2 - Optimal (9.684 GB)

Properties

Device 1 - Optimal (9.684 GB)

Device	Status
State	Optimal
Additional details	Quick initialized
Read-cache mode	Enabled
Write-cache mode	Enabled (write-back)
Write-cache setting	Enabled (write-back)
Partitioned	No
Protected by hot spare	No
Bad stripes	Yes

...on Device 1.
Right-click **Device 1**, then select **Properties** to continue tracing the fault to its source...

...bad stripes.

Recovering from a Disk Drive Failure

When a disk drive fails for any reason, it is represented in Adaptec Storage Manager with a red X, as shown at right.



This section explains how to recover when a disk drive fails:

- If the logical drive was protected by a hot spare (see the following section).
- If the logical drive was *not* protected by a hot spare (see [page 136](#)).
- If there is a disk drive failure in more than one logical drive simultaneously (see [page 136](#)).
- If it is a RAID 0 logical drive (see [page 136](#)).
- If multiple disk drives fail within the same logical drive (see [page 137](#)).

Failed Disk Drive Protected by a Hot Spare

When a logical drive is protected by a hot spare, if a disk drive in that logical drive fails the hot spare is automatically incorporated into the logical drive and takes over for the failed drive.

For instance, when a disk drive fails in the RAID 5 logical drive shown in the next example, the logical drive is automatically *rebuilt* (its data is reconstructed) using the hot spare in place of the failed drive. You can't access the logical drive until the rebuilding is complete.

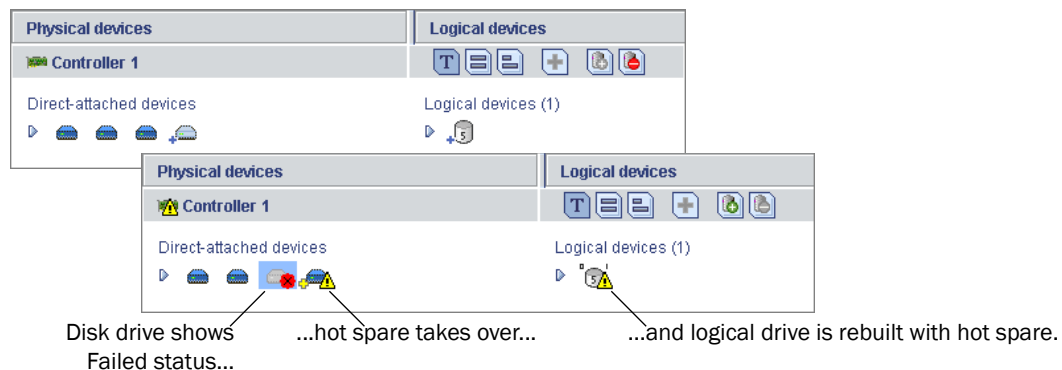

Note: In this example, the color of the hot spare changed from light-blue to dark-blue, showing that it is now part of a logical drive.

To recover from the failure:

- 1 Remove and replace the failed disk drive (following manufacturer's instructions).
- 2 *If copyback is not enabled*—Remove the 'hot spare' designation from the original hot spare (the disk drive that was built into the logical drive). See [page 84](#) for instructions. Then, designate a new hot spare to protect the logical drives on that controller.

If copyback is enabled—Data is automatically moved back to its original location once the controller detects that the failed drive has been replaced. No action is required. See [Enabling Copyback on page 89](#) for more information.

Failed Disk Drive Not Protected by a Hot Spare

When a logical drive is not protected by a hot spare, if a disk drive in that logical drive fails, remove and replace the failed disk drive. The controller detects the new disk drive and begins to rebuild the logical drive.

For instance, when one of the disk drives fails in the RAID 1 logical drive shown in the next example, the logical drive is *not* automatically rebuilt. The failed disk drive must be removed and replaced before the logical drive can be rebuilt.

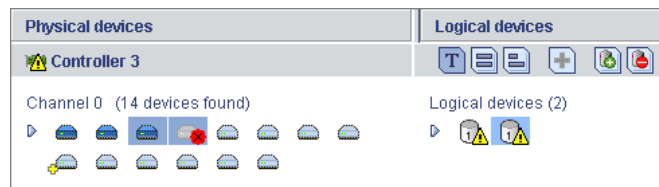

If the controller fails to rebuild the logical drive, check that the cables, disk drives, and controllers are properly installed and connected. Then, if necessary, follow the instructions in [Rebuilding Logical Drives on page 137](#).

Failure in Multiple Logical Drives Simultaneously

If there's a disk drive failure in more than one logical drive at the same time (one failure per logical drive), and the logical drives have hot spares protecting them, the controller rebuilds the logical drives with these limitations:

- A hot spare must be of equal or greater size than the failed disk drive it's replacing.
- Failed disk drives are replaced with hot spares in the order in which they failed. (The logical drive that includes the disk drive that failed first is rebuilt first, assuming an appropriate hot spare is available—see the previous bullet.)

If there are more disk drive failures than hot spares, see [Failed Disk Drive Not Protected by a Hot Spare on page 136](#).

If copyback is enabled, data is moved back to its original location once the controller detects that the failed drive has been replaced. See [Enabling Copyback on page 89](#) for more information.

Disk Drive Failure in a RAID 0 Logical Drive

Because RAID 0 volumes do not include redundancy, if a disk drive fails in a RAID 0 logical drive, the data can't be recovered.

Correct the cause of the failure or replace the failed disk drives. Then, restore your data (if available).

Multiple Failures in the Same Logical Drive

Except in RAID 6 and RAID 60 logical drives (see [page 165](#)), if more than one disk drive fails at the same time in the same logical drive, the data can't be recovered.

Correct the cause of the failure or replace the failed disk drives. Then, restore your data (if available).

Note: In some instances, RAID 10 and RAID 50 logical drives *may* survive multiple disk drive failures, depending on which disk drives fail. See [Selecting the Best RAID Level on page 157](#) for more information.

Removing a Failed Disk Drive's Icon

Note: You can only complete this task on disk drives that are not included in any logical drive.

When a disk drive fails, it may still appear in Adaptec Storage Manager although it is no longer available. To see an accurate representation of your storage space and make it easier to monitor your disk drives, you can remove a failed disk drive from the Physical Devices View.

In the Physical Devices View, right-click the failed disk drive, then click **Remove failed drive**.

Rebuilding Logical Drives

A *hot-swap rebuild* occurs when a controller detects that a failed disk drive in a logical drive has been removed and then reinserted.

To start a hot-swap rebuild:

- 1 Following manufacturer's instructions, gently pull the failed disk drive from the server without fully removing it, then wait for it to spin down fully before continuing.
- 2 If there is nothing wrong with the disk drive, reinstall it, following manufacturer's instructions.
If necessary, replace the failed disk drive with a new disk drive of equal or larger size.
- 3 The controller detects the reinserted (or new) disk drive and begins to rebuild the logical drive.

Solving Notification Problems

To test notifications on your storage space, you can send test events or emails to ensure that they're being received properly.

If your test event fails:

- 1 Ensure that the remote system is powered on and running Adaptec Storage Manager.
- 2 Open the remote system's System Properties window (see [Step 3 on page 96](#)) and double-check the TCP/IP address and port number.
- 3 Try sending the test event again.

If your test email fails:

- 1 Ensure that the recipient's email address is correct. (See [Modifying a Recipient's Information on page 102](#) to modify the address.)
- 2 Ensure that your SMTP server address is correct. (See [Changing the Email Notification Manager Settings on page 104](#) to modify the address.)
- 3 Try sending the test message again.

Creating a Support Archive File

Your Adaptec Storage Manager service representative might ask you to create a configuration and status information archive file to help diagnose a problem with your system.

To create the archive file:

- 1 In the Enterprise View, click the local or remote system on which the problem is occurring.
 - 2 In the menu bar, select **Actions**, then click **Save support archive**.
 - 3 Enter a name for the archive file or accept the default name, then click **Save**.
-

Understanding Error and Warning Messages

This section provides detailed information about error and warning events that occur in Adaptec Storage Manager.

Warning Messages

Warning	Warning Message Text
ArrayCritical	Ready disk drives are still available
HotSpareTooSmall	The hot spare is too small to protect the specified array
HotSpareWontWork	At least one logical drive is not protected by the specified hot spare
InitLD	Hot spare is too small for use by at least one array
NoService	The specified logical drive was not initialized
SyncLD	Could not contact Adaptec Storage Manager Agent. Adaptec Storage Manager may not function correctly. Please start the Agent.

Error Messages

Error	Error Message Text
AbortTask	Could not stop the specified currently running task
AccessControl	Could not write the logical drive access control list
AddToDiskSet	Could not add drives to the specified diskset
AgentRemoved	Could not remove the specified Agent
ArrayInUse	Could not delete the specified array. One or more initiators are logged into a logical drive(s) contained within this array
ArraysInUse	Could not delete all of the specified arrays. One or more initiators are logged into a logical drive(s) contained within this array
BreakRemoteMirror	Could not break the specified remote mirror facet
CalibrateBatteryController	Could not recalibrate the specified battery
ChangeArrayName	Could not change the name of the specified array
ChangeBIOSMode	Could not change the BIOS-compatibility mapping
ChangeDiskSetName	Could not change the name of diskset
ChangeLogicalLun	Could not change the LUN of the specified logical drive

Error	Error Message Text
ChangeLogicalName	Could not change the name of the specified logical drive
ChangeNtpServer	Could not update the specified NTP server
ChangeTimeDate	Could not change the date and time
ChgAlarm	Could not change the alarm setting
ChgDataScrubRate	Could not change the background consistency check rate
ChgRebuildRate	Could not change the rebuild rate
ChgSCSIXferSpeed	Could not change the SCSI transfer speed
ChgStripeSize	Could not change the specified stripe size
ChgTaskPriority	Could not change task priority
ClearAdapterLogsFail	Could not clear the event logs for the specified system
ClearEnclosureLogsFail	Could not clear the event logs for specified enclosure
ClearHardDrive	Clear failed to start for the specified disk drive
CommFailure	You must re-establish communication with specified system
CommFailure1	Restart the Adaptec Storage Manager Agent to establish communication with the local system
ControllerRescan	Could not rescan for the specified controller
ControllerRestart	Could not restart the specified controller
ControllerShutDown	Could not shut down the specified controller
CreateDiskSet	Could not create the diskset
CreateLDError	There was an error creating specified logical drive
CreateSimpleVolume	Could not create a simple volume
DataScrub	Could not change the background consistency check mode
DDDDadInternal	Failed drive—Controller internal failure
DDDDdeviceNotFound	Failed drive—Device not found
DDDDdeviceNotReady	Failed drive—Specified device will not come ready
DDDDdriveAddedToSystem	Failed drive—Specified disk drive added to server
DDDDdriveNotBelong1	Failed drive—Specified disk drive does not belong
DDDDdriveNotBelong2	Failed drive—Specified disk drive does not belong
DDDDdriveNotFound	Failed drive—Specified disk drive not found
DDDDdriveNotPartOfCluster	Failed drive—Specified disk drive is not part of the cluster

Error	Error Message Text
DDHardwareError	Failed drive—Internal hardware error
DDInternalHW	Failed drive—Internal hardware error
DDIOSubSystem1	Failed drive—I/O subsystem error
DDIOSubSystem2	Failed drive—I/O subsystem error
DDIOSubSystem3	Failed drive—I/O subsystem error
DDSCSI1	Failed drive—SCSI error
DDSCSI2	Failed drive—SCSI error
DDSCSI3	Failed drive—SCSI error
DDSCSIBusParity	Failed drive—SCSI bus parity error
DDSCSIBusTest	Failed drive—SCSI bus test error
DDSCSIChanNotOperational	Failed drive—SCSI channel is not operational
DDSCSIErrUnknown	Failed drive—Unknown SCSI error
DDUnknownDriveFound	Failed drive—Unknown disk drive on controller
DDUnknownDriveInCluster	Failed drive—Unknown disk drive in cluster
DDUnknownSASError	Failed drive—Unknown SAS error
DDUserAcceptedInitChange	Failed drive—User accepted
DDUserMarked	Failed drive—User marked 'failed'
DDUserMarkedFailed	Failed drive—User marked 'failed'
DeleteArray	Could not delete the specified array
DeleteArrays	Could not delete all of the specified arrays
DeleteDiskSet	Could not delete the diskset
DeleteHArray	Could not delete the specified spanned array
DeleteLogDrive	Could not delete the specified logical drive
DisCopyBackMode	Could not disable copy back mode
DisReadCache	Could not disable read cache
DisUnattendedMode	Could not disable unattended mode
DisWriteCache	Could not disable write cache
EnclosureRestart	Could not restart the specified enclosure
EnclosureShutDown	Could not shut down the specified enclosure

Error	Error Message Text
EnCopyBackMode	Could not enable copy back mode
EnReadCache	Could not enable read cache
EnUnattendedMode	Could not enable unattended mode
EnWriteCache	Could not enable write cache
EventNotSent	Could not send the event to the system
ExportedArray	Could not export the specified array
FactoryDefault	Could not restore the configuration to the factory-default settings
FailbackDiskSet	Could not move diskset
FailedAtPort	Adaptec Storage Manager failed to start at specified port number
FailedSelfTest	Specified self-test problem code was returned from specified controller, channel, SCSI ID, S/N
FailedSelfTestStart	One or more of the selected disk drives failed to execute the self-test. View the RaidErrA.log file on the Adaptec Storage Manager Agent for details
FailedToConnect	Failed to connect to specified host name at specified port number
FailedToReadNOT	Failed to read the notification list file
FailedToReadSEC	Failed to read the user accounts file
FailIncompatible	Failed to connect to the specified host name due to incompatible software versions
FailOver	Could not fail from the active device to the passive device
FailoverDiskSet	Could not move diskset
HostList	Could not write the host initiator list
HotSwap	Could not enable the automatic rebuild on replacement operation
ImageSelect	Could not change the firmware to the specified boot image
ImportConfig	Could not copy the configuration from the specified drives
ImportedArray	Could not import the specified array
IncreaseLogDrive	Could not increase the size of the specified logical drive
InitHardDrive	Could not initialize the specified disk drive
InitLogDrive	Could not initialize the specified logical drive
KillOtherController	Could not kill other controller
LDM	Could not start the specified logical drive reconfiguration
LogIn	The user could not be logged in

Error	Error Message Text
LogOut	The user could not be logged out
MaybeReadCache	Could not set read cache mode to 'enabled when protected by battery'
MaybeWriteCache	Could not set write cache mode to 'enabled when protected by battery'
MergeOwnNS	Could not copy the configuration from the non-shared logical drives
Rebuild	Could not set the drive to the specified rebuild state
RemoveAHS	Could not delete the dedicated hot spare drive
RemoveFromDiskSet	Could not remove drives from the specified diskset
RemoveHSP	Could not delete the specified hot spare drive
RemoveSHS	Could not delete the specified standby hot-spare drive
ReplaceDHS	Could not replace the specified failed drive
RollbackSnapshot	Could not rollback the specified snapshot
ScanDrives	Could not perform the bus rescan
SetArrayOnline	Could not send the Array Optimal command to the specified controller
SetChannellInitiatorId	Could not set the specified SCSI initiator ID
SetContDiskCachePolicy	Could not change the specified global drive cache policy
SetHostId	Could not set the specified controller name
SetITNexusLossTime	Could not change I_T nexus loss time
SetMergeGroup	Could not set the specified merge-group number
SetPartnerId	Could not set the specified partner controller name
SetSpareSet	Could not change the specified spare set attribute
SetToAHotSpare	Could not create a dedicated hot spare drive
SetToDefunct	Could not set the specified drive to failed
SetToEmpty	Could not remove the specified failed drive
SetToHotSpare	Could not create a hot-spare drive
SetToOnline	Could not set the specified failed drive to optimal
SetToSHotSpare	Could not create a standby hot-spare drive
SetWce	Could not change the write-cache mode
SyncArray	Could not start the array verify
SyncLogDrive	Could not start the logical drive verify

Error	Error Message Text
TargetInfo	Could not write the logical drive target information
Unblock	Could not unblock the specified logical drive
UnkillOtherController	Could not unkill other controller
UserAccounts	Could not write the target user account list
VerifyArray	Could not start the array verify
VerifyFixHardDrive	Verify with fix failed to start
VerifyHardDrive	Verify failed to start
VolumelnUse	Could not delete the specified logical drive. One or more initiators are logged into the logical drive.

Part III: Quick Reference

Appendix A: Quick Answers to Common Questions... (page 146)

Appendix B: Buttons and Icons At-a-Glance
(page 153)

Appendix C: Selecting the Best RAID Level
(page 157)

Glossary (page 166)

Quick Answers to Common Questions...



In this appendix...

How do I...?.....	147
What's the difference between...?.....	149
What options are on the Actions menu?.....	150
What tasks can be scheduled to run at a specified time?.....	152

This chapter provides quick references to frequently requested information about basic tasks, functions, and concepts in Adaptec Storage Manager.

Note: For troubleshooting tips, see [Solving Problems on page 133](#).

How do I...?

Set up my storage space?

Follow the five steps in the *Getting Started Checklist* on page 17.

Create or add a new logical drive?

In the Enterprise View, right-click the controller you want, then click **Create logical device**.

Or, click either of the buttons shown at right.



See *Building Your Storage Space* on page 45.

Open the Configuration wizard?

In the Enterprise View, right-click the controller you want, then click **Create logical device**.

Or, click either of the buttons shown at right.



See *Building Your Storage Space* on page 45.

Turn off the alarm?

Click the **Silence** button, shown at right.



Or, from the menu bar, click **Actions**, select **Agent actions**, select **Alarm actions**, then click **Silence alarm**.

See *Silencing and Testing the Audible Alarm* on page 107.

Add a new user to Adaptec Storage Manager?

Any user with a valid network user name and password can log into Adaptec Storage Manager.

See *Starting Adaptec Storage Manager* on page 28.

Add a remote system?

Click the **Add** button, shown at right.



See *Logging In to Remote Systems* on page 58.

Prevent a user from changing my storage space?

See *Understanding Permission Levels* on page 32 for information on restricting access.

Check disk drive or logical drive status?

Hold your cursor over the disk drive or logical drive to reveal status information.

See also *Revealing More Disk Drive Information* on page 42.

Access a feature with a padlock icon beside it?

Features such as snapshot are enhanced features that must be unlocked with a special feature key (sold separately).

See *Adding Enhanced Features* on page 20.

Log out of Adaptec Storage Manager?

In the Enterprise View, click on the local system. In the menu bar, select **Actions**, then click **Log out**.

See [Logging Out of Adaptec Storage Manager](#) on page 34.

Schedule a task?

Complete each step of the task until you are prompted to click **Apply**. (*Don't* click **Apply**.) Click **Schedule**.

Note: The **Schedule** button won't appear on tasks that can't be scheduled.

See [Scheduling a Task](#) on page 110.

Find the Task Manager?

In the tool bar, click **Configure**, select the system you want, then click **Tasks**. See [Scheduling a Task](#) on page 110.

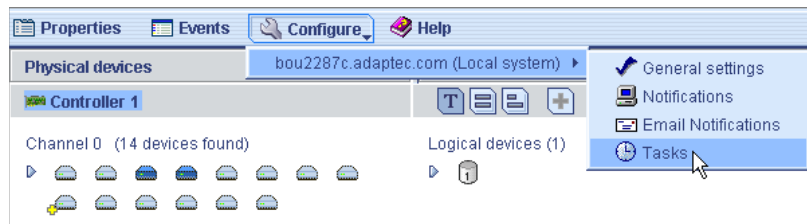

Find the Notification Manager?

In the tool bar, click **Configure**, select the system you want, then click **Notifications**. See [Setting up Event Notifications](#) on page 93.



Find the Email Notification Manager?

In the tool bar, click **Configure**, select the system you want, then click **Email Notifications**. See [Setting Up Email Notifications](#) on page 99.

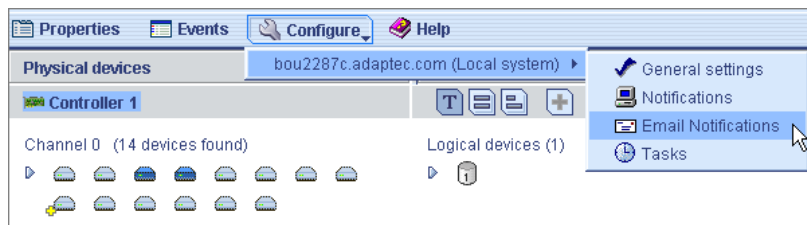

What's the difference between...?

Adaptec Storage Manager and the Agent?

Adaptec Storage Manager is the full software application, including the user interface (windows, menus) described in this *User's Guide*. It helps you build and maintain the logical drives, controllers, and disk drives that make up your storage space.

The Agent is like a service that keeps your storage space running. Its job is to monitor system health and manage event notifications, tasks schedules, and other on-going processes on each system in your storage space. The Agent can run independently of the full application.

See [About Adaptec Storage Manager on page 17](#) for more information.

Internal RAID and External RAID branches of the Enterprise View?

The Internal RAID branch helps you manage the local and remote systems in your storage space that have *internal* (or *direct-attached*) storage—a RAID controller and disk drives residing inside or directly attached to the system. Internal RAID storage can only be accessed by the system to which it is attached. This *User's Guide* addresses the internal RAID branch only.

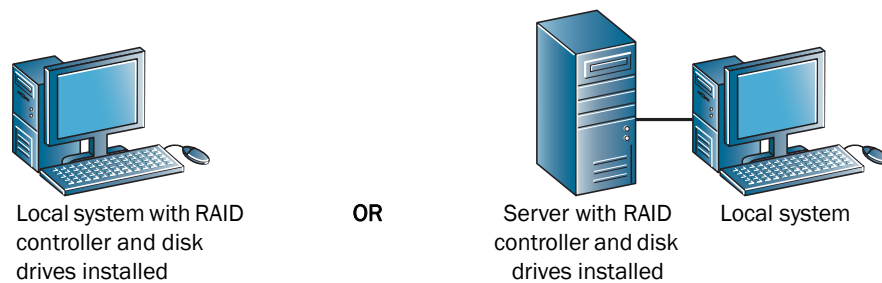

The External RAID branch helps you set up and manage *external* storage—one or more RAID controllers and multiple disk drives that reside in a server, and which is shared among multiple systems on a LAN. For more information, refer to the Adaptec Web site at www.adaptec.com.

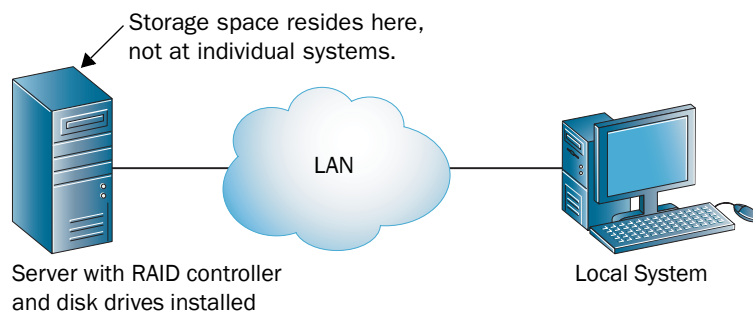

Event notifications, email notifications, and event alerts?

Event notifications (also called logged notifications) are messages about events on one system that are sent to the Event Viewer of another system in your storage space. (See [page 93](#).)

Email notifications are email messages about events on a system in your storage space that are sent to specified users. (See [page 99](#).)

Event alerts are pop-up messages or console messages about all types of events on a specific system, which are broadcast to all the users who are logged into your storage space. (See [page 105](#).)

What options are on the Actions menu?

Note: You can also access many Action menu options by right-clicking a component. For example, right-click on a system to access most of the options shown in [Local and remote systems](#) below. See [About the Actions Menu on page 44](#) for more information.

Local and remote systems

In the Enterprise View, click on a system. In the menu bar, select **Actions** to view these options:

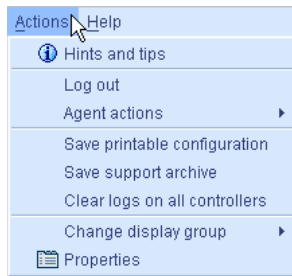

Then select **Agent actions** to view these options:

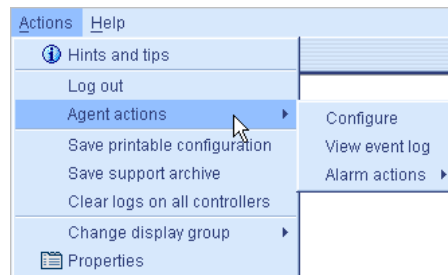

Controllers?

In the Enterprise View, click on a controller. In the menu bar, select **Actions** to view these options:

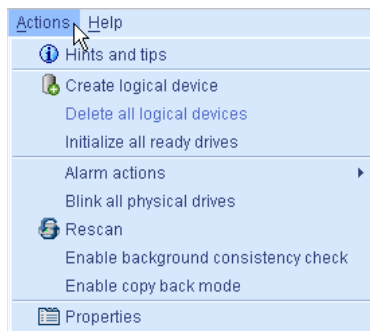

Disk drives?

In the Physical Devices View, click on a disk drive. In the menu bar, select **Actions** to view these options:

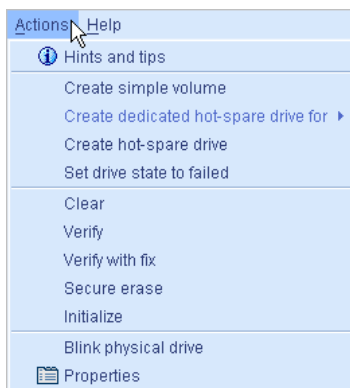

Enclosures?

In the Physical Devices View, click on an enclosure management device. In the menu bar, select **Actions** to view these options:

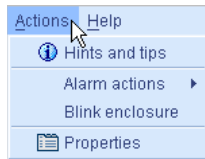

Logical drives?

In the Logical Devices View, click on a logical drive. In the menu bar, select **Actions** to view these options:

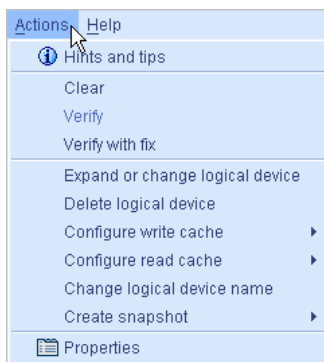

Internal RAID storage?

In the Enterprise View, click **Internal RAID**. In the menu bar, select **Actions** to view these options:

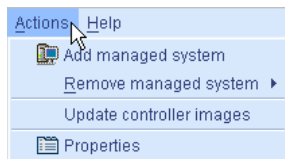

The Notification Manager?

In the tool bar, click **Configure**, select the system you want, then click **Notifications**. In the menu bar, select **Actions** to view these options:

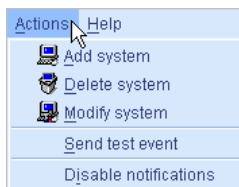

The Email Notification Manager?

In the tool bar, click **Configure**, select the system you want, then click **Email Notifications**. In the menu bar, select **Actions** to view these options:

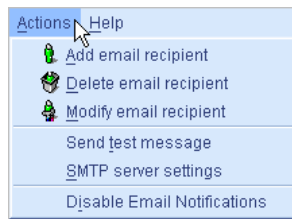

The Task Manager?

In the tool bar, click **Configure**, select the system you want, then click **Tasks**. In the menu bar, select **Actions** to view these options:

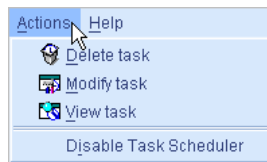

What tasks can be scheduled to run at a specified time?

You can schedule any of these tasks to run at a specified time:

- Changing a logical drive from one RAID level to another (see [page 79](#)).
- Expanding the size of a logical drive (see [page 77](#)).
- Modifying a logical drives settings (see [page 71](#)).
- Verifying a logical drive (see [page 76](#)) or verifying and fixing a logical drive (see [page 75](#)).

See [Scheduling a Task](#) on [page 110](#) for more information.

Buttons and Icons At-a-Glance



B

In this appendix...











- Enterprise View Icons 154
- Icons in the Physical Devices View 154
- Icons in the Logical Devices View 155
- Buttons in the Main Window 155
- Buttons in the Notification Manager 156
- Buttons in the Email Notification Manager 156
- Buttons in the Task Manager 156

This chapter provides quick references to the icons and buttons that appear in Adaptec Storage Manager.









Enterprise View Icons

Icon	Description
	System with internal RAID controller and directly attached disk drives or enclosures
	Enclosure
	Controller









Icons in the Physical Devices View

Icon	Description
	Ready disk drive
	Disk drive with free space
	Disk drive with no free space
	Failed disk drive
	Healthy global or dedicated hot spare
	Hot spare with error (see page 83 for more information)
	Hot spare being built into logical drive after disk drive failure
	Hot spare built into logical drive after disk drive failure
	Controller
	Enclosure Management Device
	Locked upgrade feature that can be activated with a feature key (see page 20 for more information)













Enclosure Status Icons





Icon	Description
	Enclosure fan(s) – normal
	Enclosure fan(s) – error
	Enclosure temperature – normal
	Enclosure temperature – error
	Enclosure Power – normal
	Enclosure Power – error
	Enclosure fan(s) – warning
	Enclosure temperature – warning
	Enclosure Power – warning

Icons in the Logical Devices View



Icon	Description
	Logical drive
	Logical drive with healthy hot spare
	Logical drive with a snapshot
	Logical drive being initialized
	Logical drive being modified
	Logical drive being rebuilt after disk drive failure
	Array with available space
	Array with no available space
	Locked upgrade feature that can be activated with a feature key (see page 20 for more information)

Buttons in the Main Window



Button	Click to...	More on...
	...add a remote system	... page 58
	...create a logical drive; open the Configuration wizard	... page 45
	...silence the audible alarm	... page 107
	...check status and other properties of a controller, disk drive, or other component	... page 121
	...view the full Event log	... page 92
	...configure the Adaptec Storage Manager Agent settings ...configure notification settings ...configure email notification settings ...check the status of scheduled tasks; monitor and modify scheduled tasks	... page 62 ... page 93 ... page 99 ... page 109
	...open the online Help	... page 44
	...see a text description of your disk drives	... page 42
	...see the size capacities of your disk drives	... page 43
	...see the size capacities of your disk drives relative to each other	... page 43
	...create a global hot spare	... page 82
	...create a logical drive	... page 45
	...delete a logical drive	... page 80
	...expand and collapse additional information about disk drives and logical drives	... page 42

Button	Click to...	More on...
 Logical devices	...access logical drive-specific functions, such as deleting	...page 121
 Channel	...access channel-specific functions, such as rescanning	...page 121
 Ports	...access port-specific functions, such as blinking	...page 121
 Device	...access device-specific functions, such as initializing	...page 121



Buttons in the Notification Manager

Button	Click to...	More on...
 Add system	...add a system that will receive notifications generated by the Notification Manager	...page 93
 Modify system	...update a system's address, host name, or notification level	...page 96
 Delete system	...remove a system from the Notification List	...page 96

Buttons in the Email Notification Manager

Button	Click to...	More on...
 Add email recipient	...add the email address of a user who will receive notifications generated by the Email Notification Manager	...page 99
 Modify email recipient	...update a recipient's email address or notification level	...page 102
 Delete email recipient	...remove a recipient from the Email Notification List	...page 102

Buttons in the Task Manager

Button	Click to...	More on...
 View task	...view the details of a scheduled task	...page 112
 Modify task	...reschedule a task or change the description of the task in the Task List	...page 113
 Delete task	...delete a task that is no longer required	...page 114

Selecting the Best RAID Level



In this appendix...

Comparing RAID Levels	158
Understanding Drive Segments	158
Non-redundant Logical Drives (RAID 0)	159
RAID 1 Logical Drives.....	160
RAID 1 Enhanced Logical Drives	160
RAID 10 Logical Drives.....	161
RAID 5 Logical Drives.....	162
RAID 5EE Logical Drives	163
RAID 50 Logical Drives.....	164
RAID 6 Logical Drives.....	165
RAID 60 Logical Drives.....	165

When you create logical drives in Adaptec Storage Manager, you can assign a RAID level to protect your data.

Each RAID level offers a unique combination of performance and redundancy. RAID levels also vary by the number of disk drives they support.

This chapter provides a comparison of all the RAID levels supported by Adaptec Storage Manager, and provides a basic overview of each to help you select the best level of protection for your storage system.

Comparing RAID Levels

Use this table to select the RAID levels that are most appropriate for the logical drives on your storage space, based on the number of available disk drives and your requirements for performance and reliability.

RAID Level	Redundancy	Disk Drive Usage	Read Performance	Write Performance	Built-in Hot Spare	Minimum Disk Drives
RAID 0	No		***	***	No	2
RAID 1	Yes	50%	**	**	No	2
RAID 1E	Yes	50%	**	**	No	3
RAID 10	Yes	50%	**	**	No	4
RAID 5	Yes	67% - 94%	***	*	No	3
RAID 5EE	Yes	50% - 88%	***	*	Yes	4
RAID 50	Yes	67% - 94%	***	*	No	6
RAID 6	Yes	50% - 88%	**	*	No	4
RAID 60	Yes	50% - 88%	**	*	No	8
Spanned Volume	No	100%	***	***	No	2
RAID Volume	No	50% - 100%	***	***	No	4

Disk drive usage, read performance, and write performance depend on the number of drives in the logical drive. In general, the more drives, the better the performance.

More information about each RAID level is available beginning on [page 159](#).

Understanding Drive Segments

A *drive segment* is a disk drive or portion of a disk drive that is used to create a logical drive. A disk drive can include both *RAID segments* (segments that are part of a logical drive) and available segments. Each segment can be part of only one logical drive at a time. If a disk drive is not part of any logical drive, the entire disk is an available segment.

Non-redundant Logical Drives (RAID 0)

A logical drive with RAID 0 includes two or more disk drives and provides data *striping*, where data is distributed evenly across the disk drives in equal-sized sections. However, RAID 0 arrays do not maintain redundant data, so they offer *no data protection*.

Compared to an equal-sized group of independent disks, a RAID 0 array provides improved I/O performance.

Drive segment size is limited to the size of the smallest disk drive in the logical drive. For instance, a logical drive with two 250 GB disk drives and two 400 GB disk drives can create a RAID 0 drive segment of 250 GB, for a total of 1000 GB for the volume, as shown in this figure.

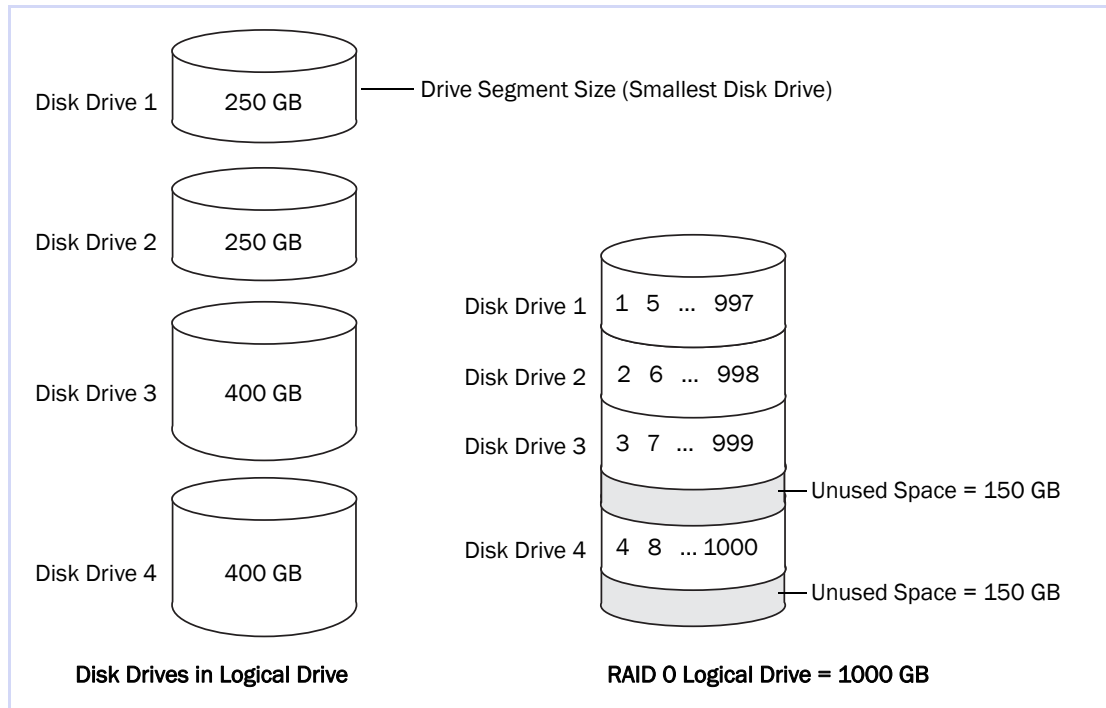

RAID 1 Logical Drives

A RAID 1 logical drive is built from two disk drives, where one disk drive is a *mirror* of the other (the same data is stored on each disk drive). Compared to independent disk drives, RAID 1 logical drives provide improved performance, with twice the read rate and an equal write rate of single disks. However, capacity is only 50 percent of independent disk drives.

If the RAID 1 logical drive is built from different-sized disk drives, drive segment size is the size of the smaller disk drive, as shown in this figure.

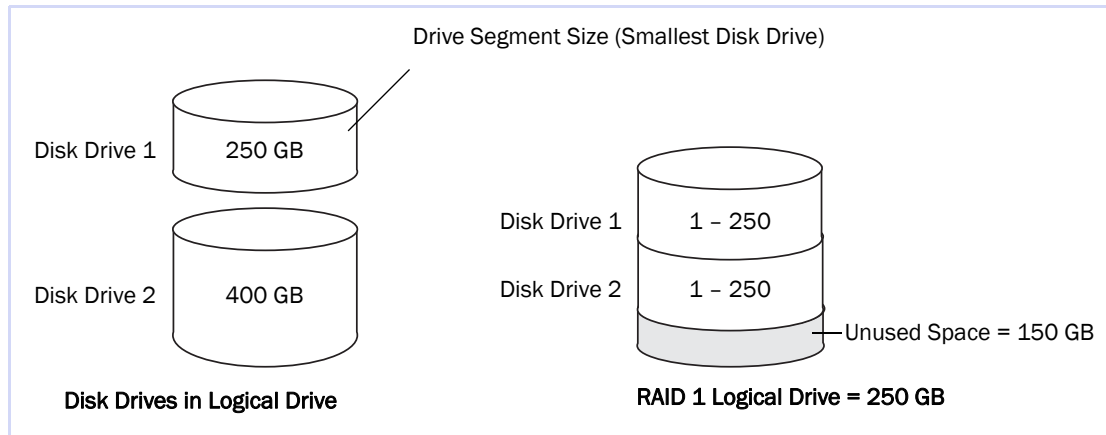

RAID 1 Enhanced Logical Drives

A RAID 1 Enhanced (RAID 1E) logical drive—also referred to as a *striped mirror*—is similar to a RAID 1 logical drive except that data is both mirrored *and* striped, and more disk drives can be included. A RAID 1E logical drive can be built from three or more disk drives.

In this figure, the large bold numbers represent the striped data, and the smaller, non-bold numbers represent the mirrored data stripes.

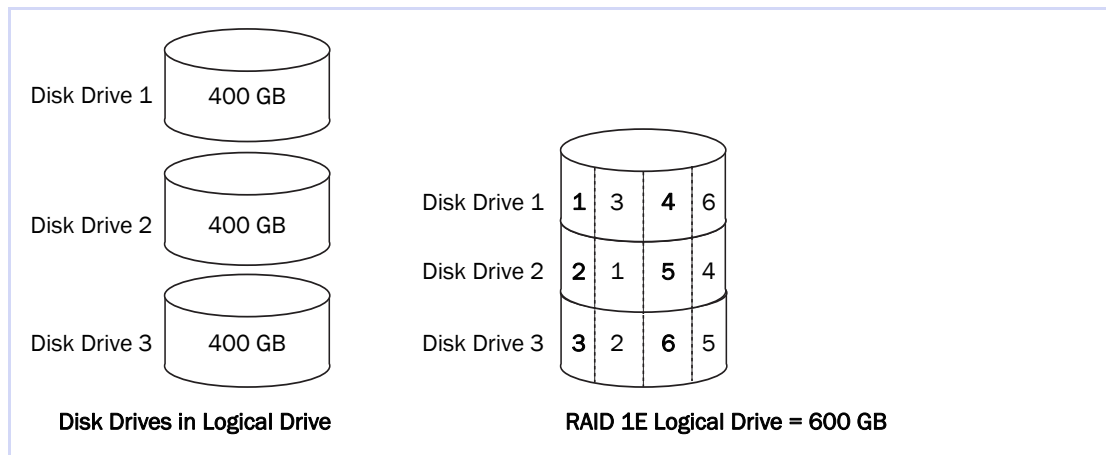

RAID 10 Logical Drives

A RAID 10 logical drive is built from two or more equal-sized RAID 1 logical drives. Data in a RAID 10 logical drive is both striped and mirrored. Mirroring provides data protection, and striping improves performance.

Drive segment size is limited to the size of the smallest disk drive in the logical drive. For instance, a logical drive with two 250 GB disk drives and two 400 GB disk drives can create two mirrored drive segments of 250 GB, for a total of 500 GB for the logical drive, as shown in this figure.

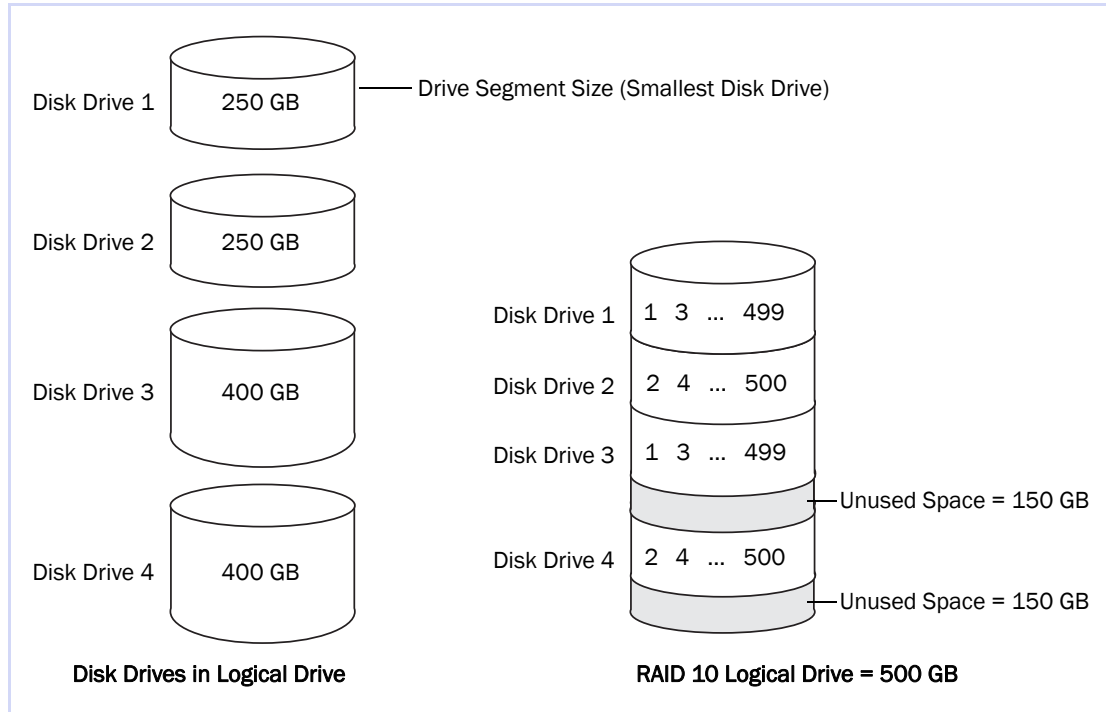

RAID 5 Logical Drives

A RAID 5 logical drive is built from a minimum of three disk drives, and uses data striping and *parity* data to provide redundancy. Parity data provides data protection, and striping improves performance.

Parity data is an error-correcting redundancy that's used to re-create data if a disk drive fails. In RAID 5 logical drives, parity data (represented by Ps in the next figure) is striped evenly across the disk drives with the stored data.

Drive segment size is limited to the size of the smallest disk drive in the logical drive. For instance, a logical drive with two 250 GB disk drives and two 400 GB disk drives can contain 750 GB of stored data and 250 GB of parity data, as shown in this figure.

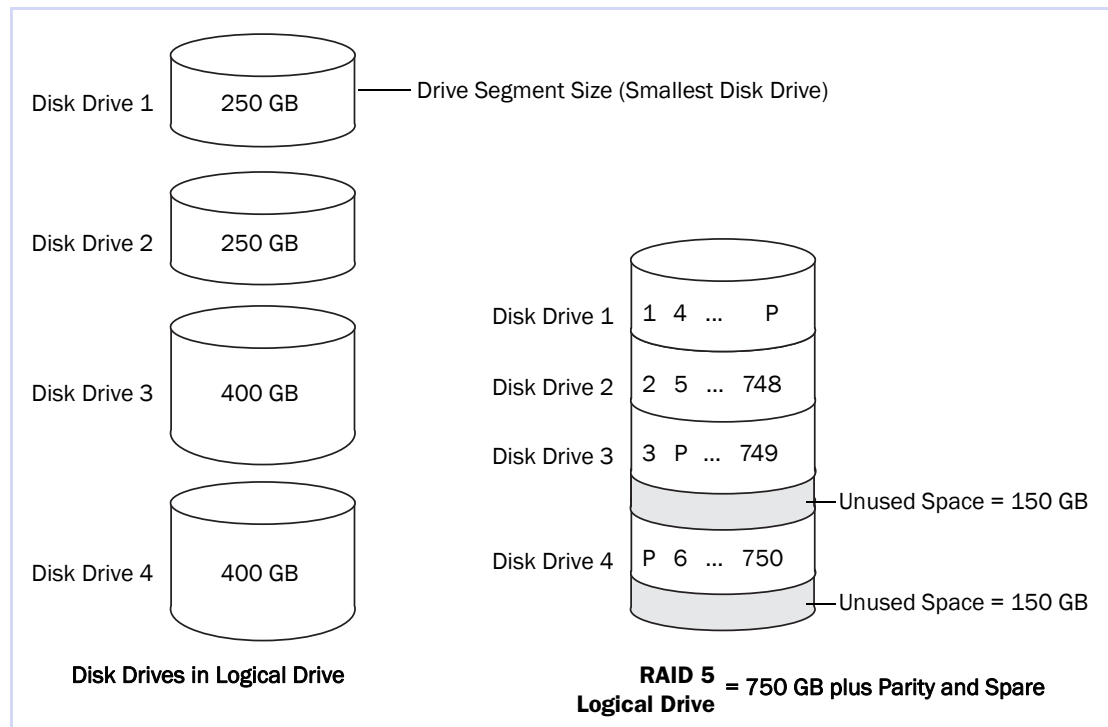

RAID 5EE Logical Drives

A RAID 5EE logical drive—also referred to as a *hot space*—is similar to a RAID 5 logical drive except that it includes a *distributed spare* drive and must be built from a minimum of four disk drives.

Unlike a hot spare (see [page 81](#)), a distributed spare is striped evenly across the disk drives with the stored data and parity data, and can't be shared with other logical disk drives. A distributed spare improves the speed at which the logical drive is rebuilt following a disk drive failure.

A RAID 5EE logical drive protects your data and increases read and write speeds. However, capacity is reduced by two disk drives' worth of space, which is for parity data and spare data.

In this example, S represents the distributed spare, P represents the distributed parity data.

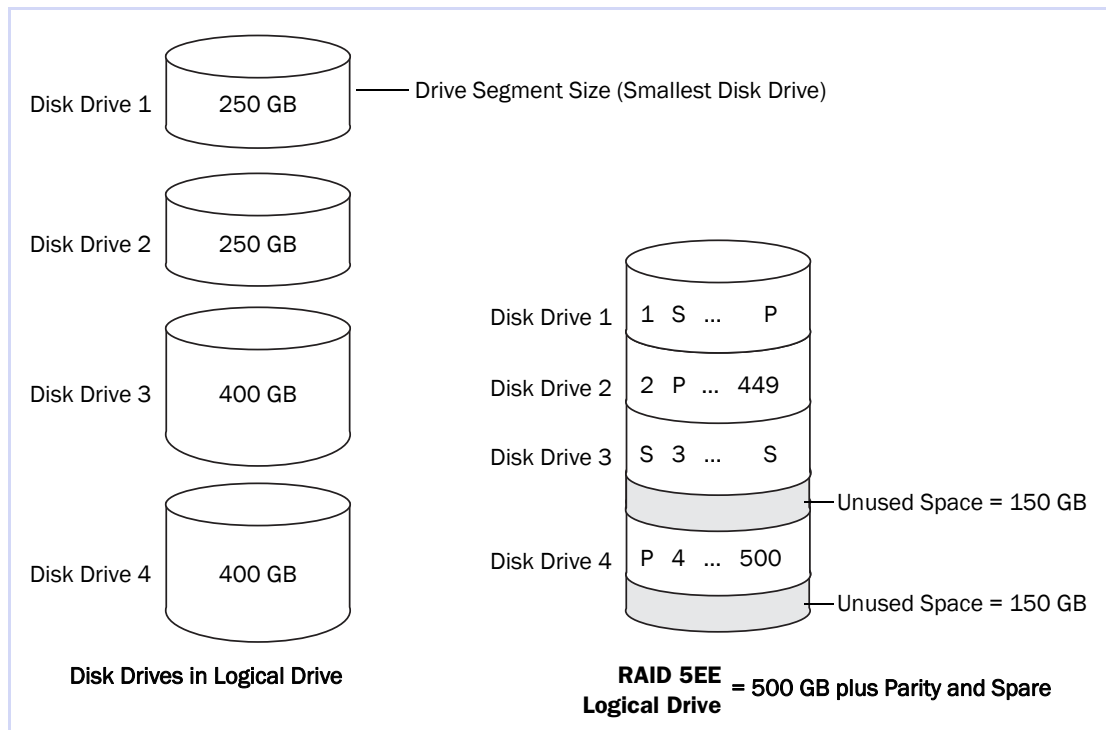

RAID 50 Logical Drives

A RAID 50 logical drive is built from at least six disk drives configured as two or more RAID 5 logical drives, and stripes stored data and parity data across all disk drives in both RAID 5 logical drives. (For more information, see [RAID 5 Logical Drives on page 162](#).)

The parity data provides data protection, and striping improves performance. RAID 50 logical drives also provide high data transfer speeds.

Drive segment size is limited to the size of the smallest disk drive in the logical drive. For example, three 250 GB disk drives and three 400 GB disk drives comprise two equal-sized RAID 5 logical drives with 500 GB of stored data and 250 GB of parity data. The RAID 50 logical drive can therefore contain 1000 GB (2 x 500 GB) of stored data and 500 GB of parity data.

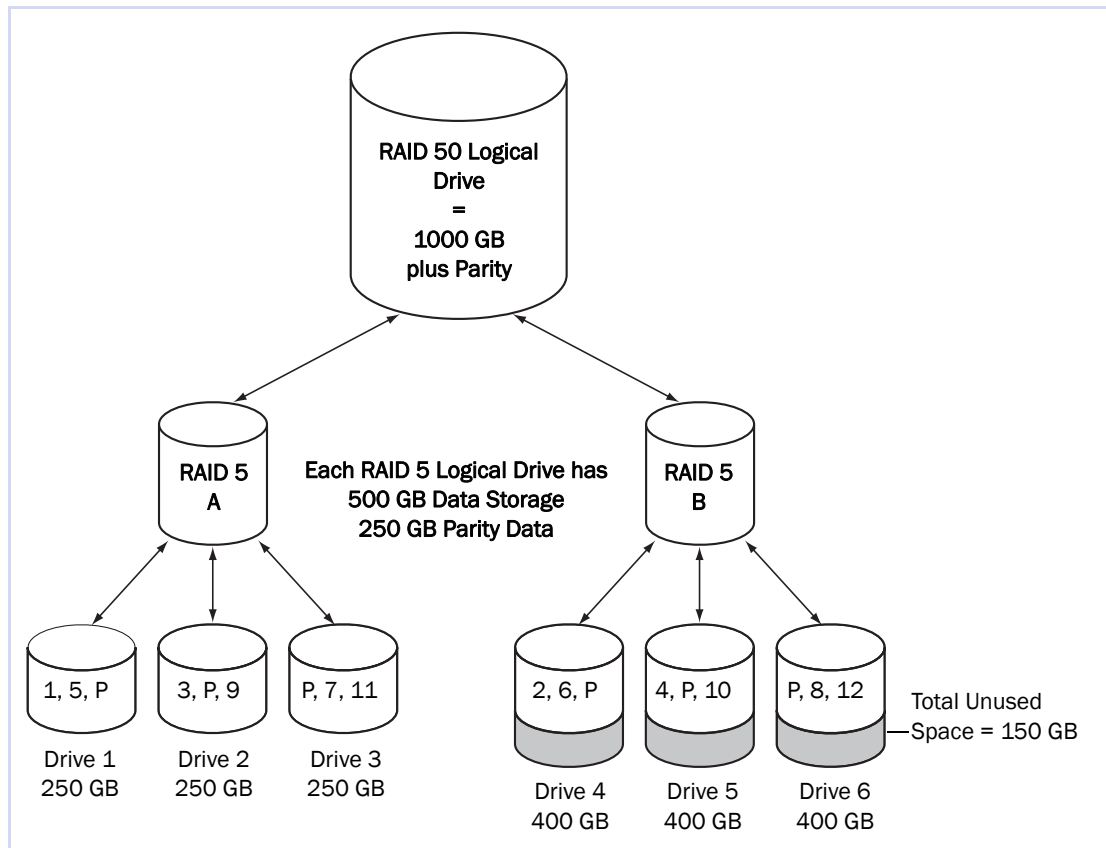

In this example, P represents the distributed parity data.

RAID 6 Logical Drives

A RAID 6 logical drive—also referred to as *dual drive failure protection*—is similar to a RAID 5 logical drive because it uses data striping and parity data to provide redundancy. However, RAID 6 logical drives include *two* independent sets of parity data instead of one. Both sets of parity data are striped separately across all disk drives in the logical drive.

RAID 6 logical drives provide extra protection for your data because they can recover from two simultaneous disk drive failures. However, the extra parity calculation slows performance (compared to RAID 5 logical drives).

RAID 6 logical drives must be built from at least four disk drives. Maximum stripe size depends on the number of disk drives in the logical drive.

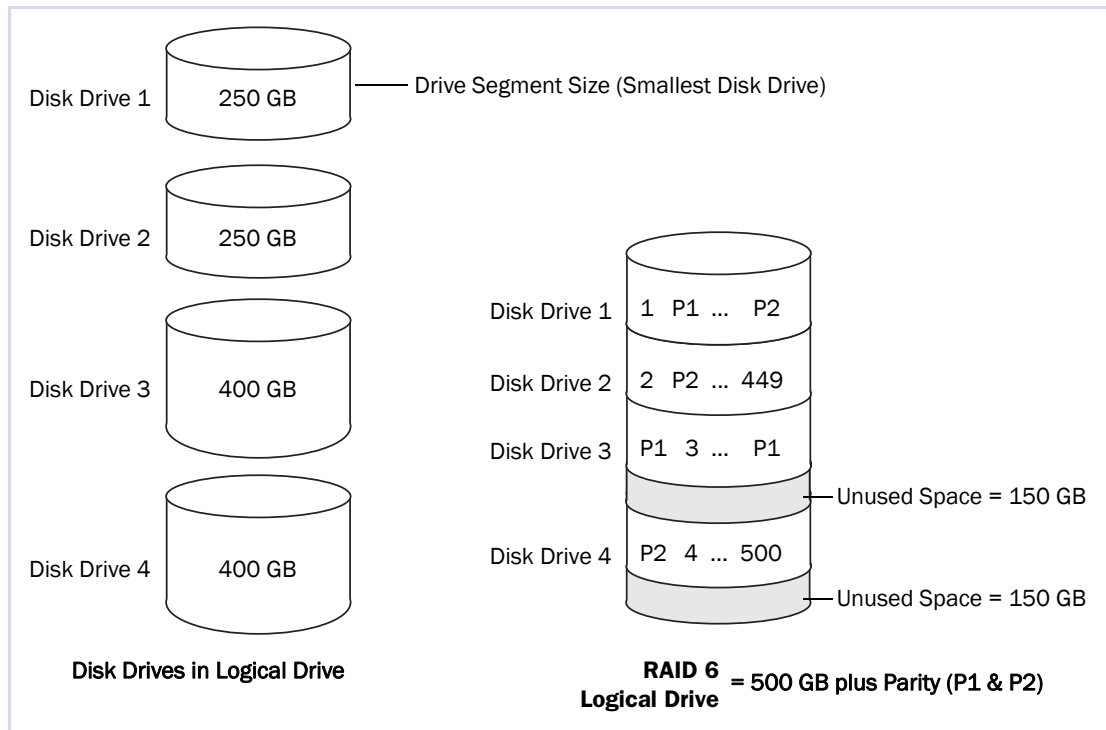

RAID 60 Logical Drives

Similar to a RAID 50 logical drive (see [page 164](#)), a RAID 60 logical drive—also referred to as *dual drive failure protection*—is built from at least eight disk drives configured as two or more RAID 6 logical drives, and stripes stored data and two sets of parity data across all disk drives in both RAID 6 logical drives.

Two sets of parity data provide enhanced data protection, and striping improves performance. RAID 60 logical drives also provide high data transfer speeds.

Glossary

A

Adaptec Storage Manager Agent

Runs in the background on your system, monitoring and managing event notifications, tasks schedules, and other on-going processes in your storage space. It requires no user intervention and includes no user interface.

available space

Space on a disk drive that is not being used by a logical drive. When a logical drive is deleted, its space becomes available. *See also* [logical drive](#).

B

background consistency check

A controller function that continually and automatically verifies your logical drives once they're in use.

bootable-CD mode

A way of running Adaptec Storage Manager, where the application is not installed but is run directly from a CD.

C

cache

A temporary, fast storage area that holds data from a slower storage device for quick access. Cache storage is normally transparent to the accessing device.

channel

Any path used for the transfer of data and the control of information between disk drives and a RAID controller.

controller

A hardware device that interprets signals between a host and a disk drive. Also known as an adapter or card. *See also* [I/O](#).

copyback

Adaptec RAID controller feature that allows data that has been moved to a hot spare to be returned to its original location once the controller detects that the failed drive has been replaced.

D

DAS

Direct-attached Storage. Data storage that is physically connected to a server. *See also* [LAN](#), [SAN](#).

drive segment

See [segment](#).

dual drive failure protection

Another name for a RAID 6 or RAID 60 logical drive.

E

Email Notification Manager

A utility within Adaptec Storage Manager that emails event messages to selected recipients. *See also* [email notifications](#), [Notification Manager](#).

email notifications

Event messages about remote systems that are emailed to selected recipients.

event

Activity on your storage space, such as a disk drive failure or logical drive verification.

F

fault tolerance

The ability of a system to continue to perform its functions even when one or more disk drives have failed.

firmware

A combination of hardware and software; software written onto read-only memory (ROM).

format

See [initialize](#).

G

GB

GigaByte. 1,024 MB. *See also* [MB](#).

H

host

A system that's connected to a TCP/IP network. *See also* [TCP/IP](#).

host bus adapter (HBA)

An adapter card that includes all of the I/O logic, software, and processing to manage the transfer of information between the host and the devices it's connected to.

hot space

A RAID 5EE logical drive. *See* [page 163](#).

hot spare

A spare disk drive which will automatically replace a failed disk drive in a logical drive.

hot-swap

Remove and replace a failed disk drive in a logical drive without shutting down the server or disrupting activity on the logical drive.

I**Storage Manager Agent**

Runs in the background on your system, monitoring and managing event notifications, tasks schedules, and other on-going processes in your storage space. It requires no user intervention and includes no user interface.

initialize

Prepare a disk drive for reading and writing.

I/O

Input/Output. Data entering into or being extracted from a system.

L**LAN**

Local Area Network. A network of interconnected workstations sharing the resources of a single server, typically within the area of a small office building.

LED

Light-emitting Diode. An electronic device that lights up when powered.

local system

The computer (or *system*) that you're working on. In Adaptec Storage Manager, 'local' and 'remote' are relative terms. *See also* [remote system](#).

logged notifications

Event messages about remote systems that appear in the Event Viewer of Adaptec Storage Manager. *See also* [Notification Manager](#).

logical drive

One or more disk drives grouped together to appear as a single device to an operating system. Also known as a logical device or array.

M**managed system**

A computer (or *system*) in a storage space that's being managed by Adaptec Storage Manager.

MB

MegaByte. Depending on context, 1,000,000 or 1,048,576 bytes. Also 1000 KB.

mirroring

Data protection that duplicates all data from one drive onto a second drive. *See also* [RAID](#).

N**Notification Manager**

A utility within Adaptec Storage Manager that broadcasts event messages to selected managed systems.

P**parity**

A form of data protection used by some RAID levels to re-create the data of a failed disk drive in a logical drive. *See also* [RAID](#).

partition

Divides the space of a disk drive into isolated sections.

port

A connection point to a controller, disk drive, expander, enclosure, or other device.

R**RAID**

Redundant Array of Independent Disks. For more information on RAID and all supported RAID levels, see [Selecting the Best RAID Level on page 157](#).

rapid fault isolation

The trail of yellow or red warning icons that leads from the high-level system view to the failed or failing component.

rebuild

Re-create a logical drive after a disk drive failure.

recurring task

A scheduled task, such as logical drive verification, that occurs on a regular basis. *See also* [Task Manager](#), [scheduled task](#).

redundancy

The capability of preventing data loss if a disk drive fails. *See also* [mirroring](#), [parity](#).

remote system

In Adaptec Storage Manager, all other systems in your storage space besides your local system are remote systems. 'Local' and 'remote' are relative terms. *See also* [local system](#).

ROM Update wizard

A program that updates the BIOS and firmware codes on the controller. *See also* [firmware](#).

S**SAN**

Storage Area Network. A storage architecture that connects servers and disk drives across a network for enhanced reliability, scalability, and performance.

scheduled task

Activity, such as logical drive verification, that is set to be completed at a specified date and time. *See also* [recurring task](#).

segment

Disk drive space that has been assigned to a logical drive. A segment can include all or just a portion of a disk drive's space.

SMTP

Simple Mail Transfer Protocol.

snapshot

A frozen image of a logical drive at a particular point in time.

spare

See [hot spare](#).

storage space

The controller(s) and disk drives being managed with Adaptec Storage Manager.

stripe size

Amount of data written to one partition before the controller moves to the next partition in a stripe set.

striped mirror

A RAID 1 Enhanced, or RAID 1E, logical drive. See [page 160](#).

striping

A method of enhancing performance by spreading data evenly over multiple disk drives. Provides no data protection.

T**Task Manager**

A utility in Adaptec Storage Manager that allows you to schedule a specific activity, such as expanding a logical drive, for a time that's convenient. See *also* [scheduled task](#), [recurring task](#).

TB

TeraByte. Approximately one million-million bytes, or 1024 GB.

TCP/IP

Transmission Control Protocol/Internet Protocol. A set of communication protocols used to connect hosts on the Internet.

V**verify**

Check a logical drive for inconsistent or bad data. May also fix any data problems or parity errors.

A

- Actions menu [44](#)
- Agent actions [108](#)
 - alarm [107](#), [108](#)
 - email notifications [101](#)
 - notifications [95](#)
- Alarm actions [107](#), [108](#), [124](#), [125](#)
- Change logical device name [71](#)
- Clear logs on all controllers [92](#)
- Configure read cache [73](#)
- Configure write cache [72](#)
- controller-level options [150](#)
- Create dedicated hot-spare drive [83](#)
- Create snapshot
 - with backup [88](#)
 - without backup [88](#)
- Delete dedicated hot-spare drive [84](#)
- Delete hot-spare drive [85](#)
- Delete logical device [81](#)
- Disable email notifications [105](#)
- Disable notifications [98](#)
- Disable task scheduler [114](#)
- disk drive-level options [150](#)
- Email Notification Manager options [152](#)
- Enable (Disable) background consistency check [76](#)
- enclosure-level options [151](#)
- Expand or change logical device [71](#), [77](#), [79](#)
- Initialize [123](#)
- Initialize all ready drives [123](#)
- internal RAID branch-level options [151](#)
- Log in [34](#)
- Log out [34](#)
- logical drive-level options [151](#)
- Notification Manager options [151](#)
- overview [44](#), [150](#) to [152](#)
- Remove dedicated hot-spare drive [84](#)
- Rescan [125](#)
- Save printable configuration [126](#)
- Save support archive [138](#)
- Send test event [95](#)
- Send test message [101](#)
- Set drive state to failed [122](#)
- SMTP server settings [104](#)
- system-level options [150](#)
- Task Manager options [152](#)
- Update controller images [128](#)
- Verify [76](#)
- Verify with fix [75](#)
- activity on storage space [91](#)
- Adaptec customer support [3](#)
- Adaptec Storage Manager
 - Actions menu [44](#)
 - Actions menu overview [150](#) to [152](#)
 - Agent [17](#)
 - Agent port number [64](#)
 - beginning steps [17](#)
 - bootable-CD mode [35](#)
 - display options [61](#), [62](#)
 - Email Notification Manager [99](#)
 - enhanced features [20](#)
 - Event Viewer [91](#)
 - feature keys [20](#)
 - icons [154](#) to [155](#)
 - installing
 - Linux [25](#)
 - NetWare [26](#)
 - OpenServer [26](#)
 - Solaris [27](#)
 - UnixWare [26](#)

- VMWare 27
 - Windows 23
 - Windows silent installation 24
 - introduction 17
 - locked features 20
 - logging into remote systems 59
 - main window overview 38
 - Notification Manager 93
 - operating system support 21
 - remote systems 58
 - standard unit of measure 62
 - system requirements 21
 - Task Manager 111
 - unlocking enhanced features 20
 - Adaptec Storage Manager vs Agent 149
 - adapters. *See* controllers
 - ADDLOCAL 24
 - Administrator permissions 32
 - advanced settings 51, 71
 - Agent 17
 - alarm settings 64
 - broadcast event alerts 63
 - customizing 62
 - event log 63
 - introduction 17
 - port number 64
 - starting
 - Linux 30
 - NetWare 31
 - OpenServer 31
 - Solaris 31
 - UnixWare 31
 - Windows 30
 - alarm
 - changing settings 64
 - controllers
 - disabling 125
 - silencing 125
 - testing 124
 - disabling 64
 - controller-level 125
 - enclosure-level 127
 - system-level 107
 - duration 64
 - enabling (system-level) 107
 - enclosures
 - disabling 127
 - silencing 127
 - testing 126
 - frequency 64
 - systems
 - disabling 107
 - enabling 107
 - silencing 108
 - testing 108
 - testing
 - controller-level 124
 - enclosure-level 126
 - system-level 108
 - archive file 138
 - audible alarm. *See* alarm
 - automatic verification 74
- ## B
- background consistency check 74, 76
 - background verification 74
 - base port number 64
 - blinking components 121
 - boards. *See* controllers
 - bootable-CD mode 34 to 36
 - defined 34
 - broadcasting event alerts 105
 - Build (initialize method) 73
 - building storage space 45 to 56
 - bootable-CD mode 35
 - custom configuration 49
 - express configuration 46
 - RAID Volumes 54
 - buttons
 - Email Notification Manager 156
 - main window 155 to 156
 - Notification Manager 156
 - Task Manager 156
- ## C
- cards. *See* controllers
 - CD mode. *See* bootable-CD mode
 - Clear (initialize method) 73
 - components
 - blinking 121
 - defined 14
 - identifying 121
 - viewing properties 121
 - Configuration event detail window 91
 - Configure button 94
 - configuring 46
 - See also* building storage space
 - controllers
 - Actions menu 150
 - blinking 121
 - disabling alarm 125
 - identifying 121
 - properties 121

- registering 124
- rescanning 125
- saving configurations 126
- support by operating system 55
- testing alarm 124
- updating firmware 128

copyback 89

custom configuration 49

customer support 3

D

daemon 17

DAS. *See* internal RAID storage

dedicated hot spares 81

- creating 83
- deleting 84
- removing 84

deleting logical drives 80

devices 39

- blinking 121

direct-attached storage. *See* internal RAID storage

disabling alarm

- enclosure-level 127
- system-level 107

disk drive segments 158

disk drives

- Actions menu 150
- available space 41
- blinking 121
- capacity 43
- conceptual graphic 67
- different sizes in same logical drive 69
- failed state 122
- failure recovery
 - multiple disk drives 137
 - multiple logical drives 136
 - RAID 0 logical drives 136
 - with hot spare 135
 - without hot spare 136
- identifying 121
- initializing 123
- properties 121
- relative capacity 43
- replacing in logical drives 122
- segments in logical drives 70
- text descriptions 42
- viewing logical drives 42
- viewing status 41
- within logical drives 50

display groups 60

- adding systems 117

- creating 60
- deleting 119
- moving systems 118
- removing systems 119
- renaming display groups 118
- system status 117

distributed spare drives 163

E

Email event detail window 103

Email List 99, 102

- adding users 100
- modifying users 102
- removing users 102
- sending test emails 101

Email Log 99, 103

- clearing 103

Email Notification Manager 99 to 105

- Actions menu 152
- buttons 156
- clearing the Email Log 103
- disabling 105
- Email List 102
- Email Log 103
- email notifications 99
- failed test emails 101
- modifying settings 104
- opening 99
- re-enabling 105
- test emails 101

email notifications 99

- adding users 100
- changing "from" address 104
- changing SMTP server 104
- Email List 102
- Email Log 103
- failed test emails 101
- modifying users 102
- removing users 102
- sending test emails 101
- SMTP server settings 100

Email Notifications tab 99

Enclosure View 42

enclosures

- Actions menu 151
- blinking 121
- disabling alarm 127
- identifying 121
- monitoring 106
- properties 121
- silencing alarm 127

- status icons [43, 106](#)
- testing alarm [126](#)
- Enterprise View [38, 39](#)
 - display options [61](#)
 - icons [154](#)
 - Internal RAID vs External RAID branches [149](#)
 - sorting systems [61](#)
- Error (task status) [112](#)
- event alerts [105](#)
- event log [92](#)
 - clearing [92](#)
- event log (operating system) [63](#)
- event notifications [93](#)
 - adding systems [93, 94](#)
 - Event Viewer [93, 149](#)
 - failed test events [96](#)
 - introduction [93](#)
 - logged notifications [93](#)
 - modifying systems [96](#)
 - Notification List [95](#)
 - Notification Log [97](#)
 - removing systems [96](#)
 - sending test events [95](#)
 - sources of events [93](#)
- Event Viewer [43, 91](#)
 - event notifications [93, 149](#)
 - logged notification status [97](#)
 - logged notifications [93](#)
 - sources of events [93](#)
 - status icons [92](#)
- events [43](#)
 - sources [93](#)
 - status icons [92, 97](#)
- Events button [92](#)
- Executed (task status) [112](#)
- Executed* (task status) [112](#)
- expanding logical drives [77](#)
- express configuration [46](#)
 - RAID levels [46](#)
- external RAID storage [149](#)

F

- failed disk drives
 - multiple disk drives [137](#)
 - multiple logical drives [136](#)
 - RAID 0 logical drives [136](#)
 - without hot spare [136](#)
- fans status icon [106](#)
- FAQs [146](#)
- feature keys [20](#)
 - unlocking [20](#)

- firmware [128](#)
- formatting logical drives [48](#)
- email notifications
 - "from" address [100](#)
- Full Size Capacity View [43](#)

G

- global hot spares [81](#)
 - creating [51](#)
 - deleting [84](#)
- glossary [166](#)
- Guest permissions [32](#)

H

- hard disk, hard disk drive, hard drive. *See* disk drive
- HBA's. *See* controllers
- help [44](#)
- hot spares [40, 41, 81 to 84](#)
 - creating [51, 82](#)
 - creating dedicated [83](#)
 - creating pool [83](#)
 - dedicated, defined [81](#)
 - deleting [84](#)
 - distributed spare drives [163](#)
 - global, defined [81](#)
 - limitations [81](#)
 - removing [84](#)

I

- icons [154 to 155](#)
 - Enterprise View [154](#)
 - Logical Devices View [155](#)
 - Physical Devices View [154](#)
- identifying components [121](#)
- initialize method [73](#)
- initialize priority [73](#)
- initializing disk drives [123](#)
- INSTALLDIR [24](#)
- installing Adaptec Storage Manager [23 to 27](#)
 - Linux [25](#)
 - NetWare [26](#)
 - OpenServer [26](#)
 - Solaris [27](#)
 - UnixWare [26](#)
 - VMWare [27](#)
 - Windows [23](#)
 - silent installation [24](#)
- internal RAID storage
 - Actions menu [151](#)
 - Actions menu introduction [44](#)

Actions menu overview 150 to 152
 comparing to external RAID 149
 defined 13

J

JBODs. *See* enclosures
 jobs. *See* tasks

L

Linux

- controller support 55
- installing Adaptec Storage Manager 25
- SNMP support 132
- starting Adaptec Storage Manager 29
- starting the Agent 30

local systems 58

locked features 20

- unlocking 20

log files, clearing 98, 103

logged notifications. *See* event notifications

logging in

- logging back in 34
- permission levels 32

logging out 34

- logging back in 34

Logical Devices View 38, 41

- icons 155

logical devices. *See* logical drives

logical drives 41, 66 to 81

- Actions menu 151
- advanced settings 51, 71
- automatic verification 74
- available space on disk drives 69
- background consistency check 74
- background verification 74
- building
 - advanced 49
 - basic 46
 - changing background task priority 48
 - stop building 48
- changing RAID levels 79
- custom configuration 49
- defined 67
- definition 136
- deleting 80
- different-sized disk drives 69
- disabling background consistency check 76
- disk drive segments 70, 158
- distributed spare drives 163
- enabling background consistency check 76

- expanding 77
- extending partitions 78
- fine-tuning 71 to 73
- formatting 48
- increasing capacity 77
- initialize method 73
- initialize priority 73
- manual verification 74
- maximum size 77
- mirrored data 160
- non-redundant 159
- options for creating 46
- parity 162
- partitioning 48
- properties 121
- RAID 1 160
- RAID 10 161
- RAID 1E 160
- RAID 5 162
- RAID 50 164
- RAID 5EE 163
- RAID 6 165
- RAID 60 165
- RAID level 41
- RAID segments 158
- RAID Volumes 54
- read cache 73
- rebuilding 135, 137
- remove disk drive or segment 77
- renaming 71
- replace disk drive or segment 77
- replacing disk drives 122
- selecting disk drives 50
- selecting RAID levels 50
- setting the size 68
- size 51
 - limitations 52
- stripe size 72
- striping data 159
- verifying 74, 76
- verifying and fixing 75
- verifying icon 76
- viewing disk drives 42
- viewing status 41
- write cache setting 72

M

main window

- display options 62
- Enterprise View 38
- External RAID branch 38

- Internal RAID branch 38
- Logical Devices View 38
- menu bar 38
- overview 38
- Physical Devices View 38
- tool bar 38
- manual verification 74
- mirroring 160
- monitoring
 - clearing event log 92
 - component properties 121
 - Email Notification Manager 99
 - email notifications 99
 - event notifications 93
 - full event log 92
 - introduction 91
 - Notification Manager 93
 - status icons 92, 97
 - tasks 112

N

- NetWare
 - controller support 55
 - installing Adaptec Storage Manager 26
 - SNMP support 132
 - starting Adaptec Storage Manager 29
 - starting the Agent 31
- non-redundant logical drives 159
- Notification event detail window 97
- Notification List 94, 95
 - adding systems 93, 94
 - modifying systems 96
 - removing systems 96
 - sending test events 95
- Notification Log 94, 97
 - clearing 98
 - status icons 97
- Notification Manager 93 to 98
 - Actions menu 151
 - buttons 156
 - clearing the log 98
 - disabling 98
 - event notifications 93
 - failed test events 96
 - Notification List 95
 - Notification Log 97
 - opening 93
 - re-enabling 98
 - test events 95
- notifications 93 to 106
 - email notifications 93, 99

- event alerts 105
- event notifications 93
- introduction 93
- Notifications tab 94

O

- online help 44
- opening Adaptec Storage Manager
 - Linux 29
 - NetWare 29
 - OpenServer 29
 - Solaris 29
 - UnixWare 29
 - Windows 28
- OpenServer
 - controller support 55
 - installing Adaptec Storage Manager 26
 - starting Adaptec Storage Manager 29
 - starting the Agent 31
- operating system event log 63
- operating system support 21

P

- parity 162
- partitioning logical drives 48
- partitions 78
- permission levels 32
- Physical Devices View 38, 40
 - icons 154
- pool hot spares 83
- port number 64
- power status icon 106
- Properties button 121

Q

- Quick (initialize method) 73

R

- RAID
 - distributed spare drives 163
 - mirrored data 160
 - non-redundant logical drives 159
 - parity 162
 - RAID 0 159
 - RAID 1 160
 - RAID 10 161
 - RAID 1E 160
 - RAID 5 162
 - RAID 50 164

- RAID 5EE 163
- RAID 6 165
 - stripe size 72
- RAID 60 165
 - stripe size 72
- striping data 159
- RAID controller support 55
- RAID levels
 - changing 79
 - custom configuration 50
 - express configuration 46
 - selecting 50
- RAID segments 158
- RAID Volumes 54
- RaidCfg.log file 126
- read cache 73
- REBOOT 24
- rebuilding (defined) 135, 136
- rebuilding logical drives 137
- recurring tasks 110
- registering new controllers 124
- Relative Size Capacity View 43
- remote systems 58
 - logging in 58
 - removing 59
 - startup port number 59
- renaming logical drives 71
- rescanning controllers 125
- ROM Update wizard 128
- running Adaptec Storage Manager
 - Linux 29
 - NetWare 29
 - OpenServer 29
 - Solaris 29
 - UnixWare 29
 - Windows 28

S

- Scheduled (task status) 112
- scheduling tasks 110
 - rescheduling 113
 - supported tasks 110
 - changing RAID level 80
 - expanding logical drives 78
 - modifying logical drives 72
 - verifying 76
 - verifying with fix 75
 - See also* tasks
- segments 67, 158
- silencing alarm
 - controller-level 125

- enclosure-level 127
- system-level 108
- size limitations for logical drives 52
- size of logical drives 68
- SMTP server settings 100
- snapshots
 - creating with backup 88
 - creating without backup 88
 - deleting 89
 - limitations 87
 - snapshot backup 87
 - snapshot nobackup 87
- snapshots 89
- snapshots 87
- SNMP support
 - Linux 132
 - NetWare 132
 - Windows 131
- software license keys 20
- Solaris
 - installing Adaptec Storage Manager 27
 - starting Adaptec Storage Manager 29
 - starting the Agent 31
- spares. *See* hot spares
- stand-alone application 28
- standard unit of measure 62
- starting Adaptec Storage Manager
 - Agent only 30
 - Linux 29
 - NetWare 29
 - OpenServer 29
 - Solaris 29
 - UnixWare 29
 - Windows 28
- startup port number 59
- status
 - components 121
 - disk drives 41
 - display group systems 117
 - enclosure properties 121
 - enclosures 43, 106, 154
 - Event Viewer 43
 - Event Viewer icons 92
 - logical drive properties 121
 - Notification Log icons 97
 - task events 112
 - tasks 112
 - View buttons 42
- status icons
 - enclosures 106
 - Event Viewer 92

- Notification Log 97
- Task Manager 112
- storage space 14
 - examples 18
- stripe size 72
- striping 159
- support archive file 138
- support, customer 3
- system groups. *See* display groups
- system requirements 21
- systems
 - Actions menu 150
 - enabling alarm 107
 - local systems 58
 - properties 121
 - remote systems 58
 - sorting in Enterprise View 61
 - testing alarm 108

T

- Task Event Viewer 112
- Task List 112
- Task Manager
 - Actions menu 152
 - buttons 156
 - deleting tasks 114
 - disabling 114
 - missed start times 113
 - modifying tasks 113
 - monitoring tasks 112
 - opening 111
 - re-enabling 115
 - scheduling tasks
 - supported tasks 152
 - Task Event Viewer 112
 - Task List 112
- Task Scheduler. *See* Task Manager
- tasks
 - deleting 114
 - event status 112
 - missed start times 113
 - modifying 113
 - monitoring 112
 - recurring 110
 - scheduling 110
 - status 112
 - supported tasks 152
- Tasks tab 111
- TCP/IP port number (default) 93
- technical support 3
- Technical Support Identification (TSID) number 3

- temperature status icon 106
- terminology 14
- test events
 - email notifications 101
 - event notifications 95
 - failed email messages 101
 - failed event notifications 96
 - logged notifications 95
- testing alarm
 - controller-level 124
 - enclosure-level 126
 - system-level 108
- Text Description View 42
- tool bar buttons 155 to 156
- TSID Number
 - See* Technical Support Identification Number

U

- UnixWare
 - controller support 55
 - installing Adaptec Storage Manager 26
 - starting Adaptec Storage Manager 29
 - starting the Agent 31
- upgrade features 20
 - unlocking 20
- User permissions 32
- user permissions 32

V

- verifying and fixing logical drives 75
- verifying logical drives 74, 76
 - automatic verification 74
 - background verification 74
 - icon 76
 - manual verification 74
- View buttons 42
- Views
 - Enclosures 42
 - Full Size Capacity 43
 - Relative Size Capacity 43
 - Text Description 42
- VMWare
 - installing Adaptec Storage Manager 27

W

- Windows
 - controller support 55
 - installing Adaptec Storage Manager 23
 - silent installation 24
 - SNMP support 131

- starting Adaptec Storage Manager 28
- starting the Agent 30
- write cache 72
- write-back 72
- write-through 72



Adaptec, Inc.
691 South Milpitas Boulevard
Milpitas, CA 95035 USA

©2006 Adaptec, Inc.
All rights reserved. Adaptec and the Adaptec logo are
trademarks of Adaptec, Inc. which may be
registered in some jurisdictions.

Part Number: CDP-00175-02-A, Rev. A
JB 02/07