

**P11C-I/
NGFF2280**



Motherboard

E16461
First Edition
October 2020

Copyright © 2020 ASUSTeK COMPUTER INC. All Rights Reserved.

No part of this manual, including the products and software described in it, may be reproduced, transmitted, transcribed, stored in a retrieval system, or translated into any language in any form or by any means, except documentation kept by the purchaser for backup purposes, without the express written permission of ASUSTeK COMPUTER INC. ("ASUS").

Product warranty or service will not be extended if: (1) the product is repaired, modified or altered, unless such repair, modification or alteration is authorized in writing by ASUS; or (2) the serial number of the product is defaced or missing.

ASUS PROVIDES THIS MANUAL "AS IS" WITHOUT WARRANTY OF ANY KIND, EITHER EXPRESS OR IMPLIED, INCLUDING BUT NOT LIMITED TO THE IMPLIED WARRANTIES OR CONDITIONS OF MERCHANTABILITY OR FITNESS FOR A PARTICULAR PURPOSE. IN NO EVENT SHALL ASUS, ITS DIRECTORS, OFFICERS, EMPLOYEES OR AGENTS BE LIABLE FOR ANY INDIRECT, SPECIAL, INCIDENTAL, OR CONSEQUENTIAL DAMAGES (INCLUDING DAMAGES FOR LOSS OF PROFITS, LOSS OF BUSINESS, LOSS OF USE OR DATA, INTERRUPTION OF BUSINESS AND THE LIKE), EVEN IF ASUS HAS BEEN ADVISED OF THE POSSIBILITY OF SUCH DAMAGES ARISING FROM ANY DEFECT OR ERROR IN THIS MANUAL OR PRODUCT.

SPECIFICATIONS AND INFORMATION CONTAINED IN THIS MANUAL ARE FURNISHED FOR INFORMATIONAL USE ONLY, AND ARE SUBJECT TO CHANGE AT ANY TIME WITHOUT NOTICE, AND SHOULD NOT BE CONSTRUED AS A COMMITMENT BY ASUS. ASUS ASSUMES NO RESPONSIBILITY OR LIABILITY FOR ANY ERRORS OR INACCURACIES THAT MAY APPEAR IN THIS MANUAL, INCLUDING THE PRODUCTS AND SOFTWARE DESCRIBED IN IT.

Products and corporate names appearing in this manual may or may not be registered trademarks or copyrights of their respective companies, and are used only for identification or explanation and to the owners' benefit, without intent to infringe.

Contents

Safety information	vii
Electrical safety.....	vii
Operation safety.....	vii
Specifications Summary	ix
Chapter 1: Product Introduction	
1.1 Welcome!	1-2
1.2 Package contents	1-2
1.3 Serial number label	1-3
1.4 Special features	1-3
1.4.1 Product highlights.....	1-3
1.4.2 Innovative ASUS features.....	1-4
Chapter 2: Hardware Information	
2.1 Before you proceed	2-2
2.2 Motherboard overview	2-3
2.2.1 Placement direction.....	2-3
2.2.2 Screw holes.....	2-3
2.2.3 Motherboard layout.....	2-4
2.2.4 Layout contents.....	2-5
2.3 Central Processing Unit (CPU)	2-7
2.3.1 Installing the CPU.....	2-7
2.3.2 Installing the CPU heatsink.....	2-10
2.3.3 Uninstalling the CPU heatsink and fan.....	2-11
2.3.4 Installing the CPU heatsink in rack.....	2-11
2.4 System memory	2-13
2.4.1 Overview.....	2-13
2.4.2 Memory configurations.....	2-13
2.4.3 Installing a DIMM on a single clip DIMM socket.....	2-14
2.5 Expansion slots	2-15
2.5.1 Installing an expansion card.....	2-15
2.5.2 Configuring an expansion card.....	2-15
2.5.3 Interrupt assignments.....	2-16
2.5.4 PCI Express x16 slot (x16 Gen3 link).....	2-17
2.5.5 Installing the Baseboard Management Card.....	2-18

Contents

- 2.6 Onboard LEDs.....2-19
- 2.7 Jumpers2-22
- 2.8 Connectors2-25
 - 2.8.1 Rear panel connectors.....2-25
 - 2.8.3 Internal connectors.....2-26

- Chapter 3: Powering Up**
- 3.1 Starting up for the first time.....3-2
- 3.2 Powering off the computer.....3-3
 - 3.2.1 Using the OS shut down function.....3-3
 - 3.2.2 Using the dual function power switch.....3-3

- Chapter 4: BIOS Setup**
- 4.1 Managing and updating your BIOS4-2
 - 4.1.1 ASUS CrashFree BIOS 3 utility.....4-2
 - 4.1.2 ASUS EzFlash Utility.....4-3
 - 4.1.3 BUPDATER utility4-4
- 4.2 BIOS setup program4-6
 - 4.2.1 BIOS menu screen.....4-7
 - 4.2.2 Menu bar4-7
 - 4.2.3 Menu items.....4-8
 - 4.2.4 Submenu items4-8
 - 4.2.5 Navigation keys.....4-8
 - 4.2.6 General help.....4-8
 - 4.2.7 Configuration fields4-8
 - 4.2.8 Pop-up window.....4-8
 - 4.2.9 Scroll bar4-8
- 4.3 Main menu4-9
- 4.4 Performance Tuning menu.....4-10
- 4.5 Advanced menu4-11
 - 4.5.1 CPU Configuration4-12
 - 4.5.2 Power & Performance.....4-14
 - 4.5.3 Server ME Configuration.....4-16
 - 4.5.4 Trusted Computing.....4-16
 - 4.5.5 APM Configuration.....4-17
 - 4.5.6 Runtime Error Logging Settings.....4-17
 - 4.5.7 Onboard LAN Configuration.....4-18
 - 4.5.8 Serial Port Console Redirection.....4-19
 - 4.5.9 Intel TXT Information.....4-21

Contents

4.5.10	SIO Configuration.....	4-22
4.5.11	PCI Subsystem Settings	4-23
4.5.12	USB Configuration	4-24
4.5.13	CSM Configuration.....	4-25
4.5.14	NVMe Configuration.....	4-26
4.5.15	WHEA Configuration	4-26
4.5.16	Tls Auth Configuration.....	4-27
4.5.17	Network Stack Configuration.....	4-27
4.5.18	RAM Disk Configuration	4-28
4.5.19	iSCSI Configuration	4-29
4.6	Chipset menu	4-29
4.6.1	System Agent (SA) Configuration	4-29
4.6.2	PCH-IO Configuration	4-32
4.7	Security menu	4-34
4.8	Boot menu	4-37
4.9	Monitor menu	4-40
4.10	Tool menu.....	4-40
4.11	Event Logs menu	4-41
4.11.1	Change Smbios Event Log Settings	4-41
4.11.2	View Smbios Event Log	4-41
4.12	Server Mgmt menu.....	4-42
4.12.1	System Event Log.....	4-43
4.12.2	BMC network configuration.....	4-43
4.12.3	View System Event Log	4-44
4.13	Save & Exit menu.....	4-45
 Chapter 5: RAID Configuration		
5.1	Setting up RAID.....	5-2
5.1.1	RAID definitions	5-2
5.1.2	Installing hard disk drives.....	5-3
5.1.3	Setting the RAID item in BIOS	5-3
5.2	Intel® Rapid Storage Technology enterprise SATA/SSATA Option ROM Utility	5-4
5.2.1	Creating a RAID set	5-5
5.2.2	Deleting a RAID set.....	5-7
5.2.3	Resetting disks to Non-RAID	5-8
5.2.4	Exiting the Intel® Rapid Storage Technology enterprise SATA/SSATA Option ROM utility.....	5-9
5.2.5	Rebuilding the RAID.....	5-9

Contents

- 5.2.6 Setting the Boot array in the BIOS Setup Utility..... 5-11
- 5.3 **Intel® Rapid Storage Technology enterprise (Windows)..... 5-12**
 - 5.3.1 Creating a RAID set..... 5-13
 - 5.3.2 Changing a Volume Type..... 5-15
 - 5.3.3 Deleting a volume 5-16
 - 5.3.4 Preferences..... 5-17

Chapter 6: Driver Installation

- 6.1 **RAID driver installation 6-2**
 - 6.1.1 Creating a USB flash drive with RAID drive..... 6-2
 - 6.1.2 Installing the RAID controller driver..... 6-2
- 6.2 **Management applications and utilities installation 6-5**
- 6.3 **Running the Support DVD..... 6-5**
- 6.4 **Installing the system drivers..... 6-6**

Appendix

- P11C-I/NGFF2280 block diagram..... A-2**
- Notices A-3**
- ASUS contact information..... A-7**

Safety information

Electrical safety

- To prevent electrical shock hazard, disconnect the power cable from the electrical outlet before relocating the system.
- When adding or removing devices to or from the system, ensure that the power cables for the devices are unplugged before the signal cables are connected. If possible, disconnect all power cables from the existing system before you add a device.
- Before connecting or removing signal cables from the motherboard, ensure that all power cables are unplugged.
- Seek professional assistance before using an adapter or extension cord. These devices could interrupt the grounding circuit.
- Make sure that your power supply is set to the correct voltage in your area. If you are not sure about the voltage of the electrical outlet you are using, contact your local power company.
- If the power supply is broken, do not try to fix it by yourself. Contact a qualified service technician or your retailer.

Operation safety

- Before installing the motherboard and adding devices on it, carefully read all the manuals that came with the package.
- Before using the product, make sure all cables are correctly connected and the power cables are not damaged. If you detect any damage, contact your dealer immediately.
- To avoid short circuits, keep paper clips, screws, and staples away from connectors, slots, sockets and circuitry.
- Avoid dust, humidity, and temperature extremes. Do not place the product in any area where it may become wet.
- Place the product on a stable surface.
- If you encounter technical problems with the product, contact a qualified service technician or your retailer.

Conventions used in this guide

To ensure that you perform certain tasks properly, take note of the following symbols used throughout this manual.



DANGER/WARNING: Information to prevent injury to yourself when trying to complete a task.



CAUTION: Information to prevent damage to the components when trying to complete a task.



IMPORTANT: Instructions that you MUST follow to complete a task.



NOTE: Tips and additional information to help you complete a task.

Typography

Bold text

Indicates a menu or an item to select.

Italics

Used to emphasize a word or a phrase.

<Key>

Keys enclosed in the less-than and greater-than sign means that you must press the enclosed key.

Example: <Enter> means that you must press the Enter or Return key.

<Key1> + <Key2> + <Key3>

If you must press two or more keys simultaneously, the key names are linked with a plus sign (+).

Example: <Ctrl> + <Alt> +

Command

Means that you must type the command exactly as shown, then supply the required item or value enclosed in brackets.

Example: At DOS prompt, type the command line:

format A: /S

Specifications Summary

Processor Support / System Bus		1 x Socket LGA1151 Intel® Xeon® processor E-21xxx / E22xx product family (95W) Intel® 8th/9th Generation Core™ i3 processors Intel® Pentium™ processors Intel® Celeron™ processors
Core Logic		Intel® C242 Chipset
Form Factor		Mini-ITX, 6.7" x 6.7"
ASUS Features	Fan Speed Control	✓
	Rack Ready (Rack and Pedestal dual use)	✓
	ASUS Control Center	✓
Memory	Total Slots	2 (2 Channels)
	Voltage	1.2V
	Capacity	Maximum up to 64GB
	Memory Type	DDR4 2666/2400 ECC/non-ECC UDIMM
	Memory Size	32GB, 16GB, 8GB, 4GB
Expansion Slots (follow SSI Location number)	Total PCI/PCI-E Slots	1
	Slot Location 1	-
	Slot Location 2	-
	Slot Location 3	-
	Slot Location 4	-
	Slot Location 5	-
	Slot Location 6	-
Slot Location 7	1 x PCI-E x16 (x16 Gen3 Link)	
Storage	SATA Controller	Intel® C242: 6 x SATA 6Gb/s ports (4 by mini-SAS HD) with 1 x M.2 (NGFF 2242, PCI-E Gen3 x2 link or SATA signal and 1 x M.2(NGFF 2280, PCI-E Gen3 x4 link or SATA signal)* Intel® RSTe (Windows & Linux) (Support software RAID 0, 1, 10 & 5) * SATA 5 or SATA 6 will be disabled when M.2 is SATA signal.
	SAS Controller	Optional Kits: - ASUS PIKE II 3008-8i 8-port SAS 12G RAID card - ASUS PIKE II 3108-8i 8-port SAS 12G HW RAID card

(continued on the next page)

Networking	LAN	2 x Intel® I210AT + 1 x Mgmt LAN
Graphic	VGA	Aspeed AST2500 32MB
Onboard I/O Connectors	TPM Header	1
	PSU Connector	24-pin ATX power connector + 4-pin ATX 12V power connector
	Management Header	Onboard header for optional management card
	USB Connector/ Header	1 x USB 3.2 Gen 1 header (up to 2 devices) 1 x USB 2.0 connector (Type A USB socket)
	Fan Header	3 x 4-pin headers
	SMBus connector	1
	Chassis Intruder	1
	Front LAN LED	2
	Serial Port Header	1
	VGA Header	1
M.2 Connector	1	
Rear I/O Connectors	External USB Port	2 x USB 3.2 Gen 2 2 x USB 3.2 Gen 1
	VGA Port	1
	RJ-45	2 x GbE LAN + 1 x Mgmt LAN
Management Solution	Software	ASUS Control Center
	Out of Band Remote Management	Optional ASMB9-iKVM for KVM-over-Internet
Monitoring	CPU Temperature	✓
	FAN RPM	✓
Environment		Operation temperature: 10°C – 35°C (50°F – 95°F) Non operation temperature: -40°C – 70°C (-40°F – 158°F) Non operation humidity: 20% – 90% (Non condensing)



Specifications are subject to change without notice.

Chapter 1: Product Introduction

1.1 Welcome!

Thank you for buying an ASUS P11C-I/NGFF2280 motherboard!

The motherboard delivers a host of new features and latest technologies, making it another standout in the long line of ASUS quality motherboards!

Before you start installing the motherboard and hardware devices on it, check the items in your package with the list below.

1.2 Package contents

Check your motherboard package for the following items.

Items		Standard Gift Box Pack	Standard Bulk Pack
I/O Shield		1	10 pcs per carton
Cables	SATA 6G cable	2	--
	COM port cable	1	10 pcs per carton
Application CD	Support CD	1	1 pcs per carton
Accessory	Metal Plate for LGA1151	1	10 pcs per carton
	M.2 screw and Hex screw set	1	10 pcs per carton
Packaging Qty.		1 pc per carton	10 pcs per carton



If any of the above items is damaged or missing, contact your retailer.

1.3 Serial number label

Before requesting support from the ASUS Technical Support team, you must take note of the motherboard's serial number containing 12 characters **xxS2xxxxxxxx** shown as the figure below. With the correct serial number of the product, ASUS Technical Support team members can then offer a quicker and satisfying solution to your problems.



1.4 Special features

1.4.1 Product highlights

Latest processor technology

This motherboard supports the latest Intel® Xeon® Processor E-22xx / Core™ i3 series in LGA1151 package, which has memory and PCI Express controller integrated to support dual channel DDR4 memory and 16 PCI Express 3.0 lanes. The Intel® Xeon® E-22xx have improve CPU performance and integrated voltage regulators making it one of the most powerful and energy efficient CPU in the world.

Intel® Turbo Boost

Intel® Turbo Boost automatically allows the processor to run faster than the marked frequency if the processor is operating below its power, current, and temperature specification limits. This technology increases performance of both multi-threaded and single-threaded workloads.

Intel® Hyper Threading

The thread-level parallelism on each processor makes more efficient use of the processor resources, higher processing throughput and improved performance on today's multi-threaded software.

Intel® EM64T

The motherboard supports Intel® processors with the Intel® EM64T (Extended Memory 64 Technology). The Intel® EM64T feature allows your computer to run on 64-bit operating systems and access larger amounts of system memory for faster and more efficient computing.

DDR4 memory support

The motherboard supports DDR4 memory that features faster clock frequencies and higher data transfer rates of 2666 MT/s (million transfers per second). DDR4 offers a lower voltage standard of 1.2V that reduces memory power demand and provides improved performance.

PCI Express 3.0

PCI Express 3.0 (PCIe 3.0) is the PCI Express bus standard that provides twice the performance and speed of PCIe 2.0. It provides an optimal graphics performance, unprecedented data speed, and seamless transition with its complete backward compatibility to PCIe 1.0/2.0 devices.

Intel® I210AT LAN Solution

The motherboard comes with two Gigabit LAN controllers and ports which provide a total solution for your networking needs. The onboard Intel® I210AT Gigabit LAN controllers use the PCI Express interface and could achieve network throughput close to Gigabit bandwidth.

Enhanced Intel SpeedStep Technology (EIST)

The Enhanced Intel SpeedStep Technology (EIST) intelligently manages the CPU resources by automatically adjusting the CPU voltage and core frequency depending on the CPU loading and system speed or power requirement.

Serial ATA III technology

The motherboard supports the Serial ATA III 6 Gb/s technology through the Serial ATA interface and Intel® C242 chipset. Get enhanced scalability, faster data retrieval, double the bandwidth of current bus systems with up to 6Gbps data transfer rates.

USB 2.0 technology

The motherboard implements the Universal Serial Bus (USB) 2.0 specification that dramatically increases the connection speed from the 12 Mbps bandwidth on USB 1.1 to a fast 480 Mbps on USB 2.0. USB 2.0 is backward compatible with USB 1.1.

USB 3.2 Gen 2 technology

The motherboard implements the USB 3.2 Gen 2 technology with data transfer speeds of up to 10Gbps, faster charging time for USB-chargeable devices, and optimized power efficiency.

Temperature, fan, and voltage monitoring

The CPU temperature is monitored to prevent overheating and damage. The system fan rotations per minute (RPM) is monitored for timely failure detection. The chip monitors the voltage levels to ensure stable supply of current for critical components.

1.4.2 Innovative ASUS features

ASUS Fan Speed technology

The ASUS Fan Speed technology smartly adjusts the fan speeds according to the system loading to ensure quiet, cool, and efficient operation.

Chapter 2: Hardware Information

2.1 Before you proceed

Take note of the following precautions before you install motherboard components or change any motherboard settings.



- Unplug the power cord from the wall socket before touching any component.
 - Use a grounded wrist strap or touch a safely grounded object or a metal object, such as the power supply case, before handling components to avoid damaging them due to static electricity.
 - Hold components by the edges to avoid touching the ICs on them.
 - Whenever you uninstall any component, place it on a grounded antistatic pad or in the bag that came with the component.
 - Before you install or remove any component, ensure that the power supply is switched off or the power cord is detached from the power supply. Failure to do so may cause severe damage to the motherboard, peripherals, and/or components.
-

2.2 Motherboard overview

Before you install the motherboard, study the configuration of your chassis to ensure that the motherboard fits into it.

To optimize the motherboard features, we highly recommend that you install it in an ATX 1.1 compliant chassis.



Ensure to unplug the chassis power cord before installing or removing the motherboard. Failure to do so can cause you physical injury and damage motherboard components!

2.2.1 Placement direction

When installing the motherboard, ensure that you place it into the chassis in the correct orientation. The edge with external ports goes to the rear part of the chassis as indicated in the image below.

2.2.2 Screw holes

Place four (4) screws into the holes indicated by circles to secure the motherboard to the chassis.



DO NOT overtighten the screws! Doing so can damage the motherboard.

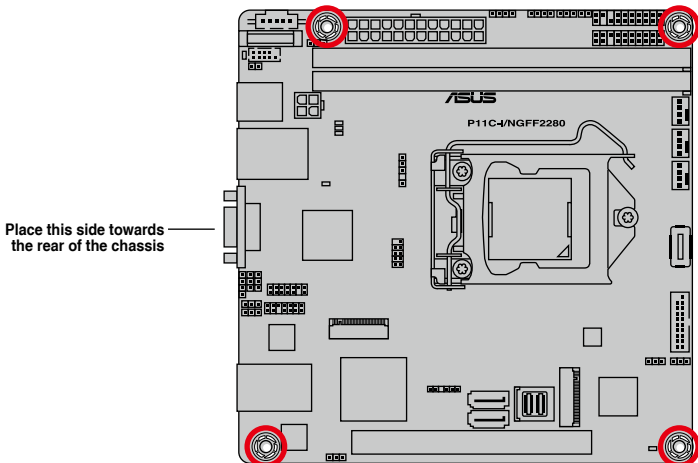

2.2.3 Motherboard layout

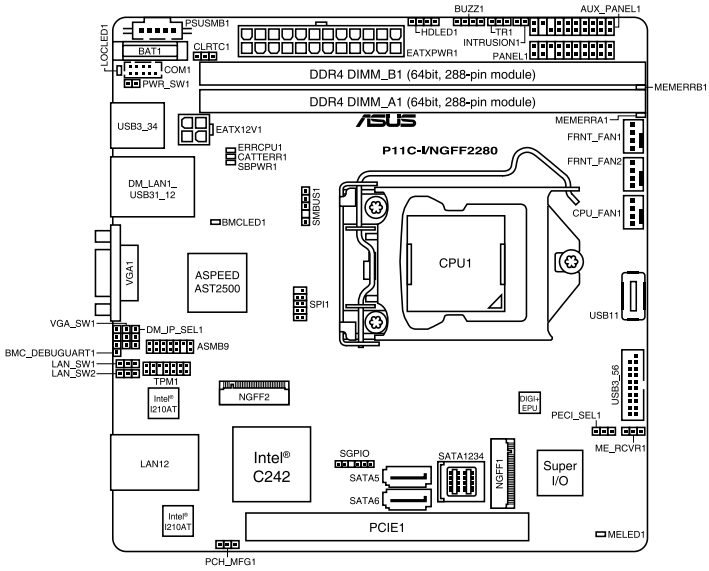

2.2.4 Layout contents

Slots/Sockets	Page
1. CPU sockets	2-7
2. DDR4 sockets	2-13
3. PCI Express x16 slot	2-17

Onboard LEDs	Page
1. Standby Power LED (SBPWR1)	2-19
2. CATT ERR LED (CATTERR1)	2-19
3. Baseboard Management Controller LED (BMCLED1)	2-20
4. CPU Warning LED (ERRCPU1)	2-20
5. ME LED (MELED1)	2-21

Jumpers	Page
1. Clear RTC RAM (3-pin CLRRTC1)	2-22
2. VGA controller setting (3-pin VGA_SW1)	2-23
3. LAN controller setting (3-pin LAN_SW1, LAN_SW2)	2-23
4. ME firmware force recovery setting (3-pin ME_RCVR1)	2-24
5. PCH_MFG1 setting (3-pin PCH_MFG1)	2-24

Rear panel connectors	Page
1. USB 3.2 Gen 1 ports 3 and 4	2-25
2. RJ-45 port for iKVM	2-25
3. Video Graphics Adapter port	2-25
4. RJ-45 ports for LAN 12	2-25
5. USB 3.2 Gen 2 ports 1 and 2	2-25

Internal connectors		Page
1.	Serial ATA 6.0 Gbps connectors (7-pin SATA 6Gbps_5 connector [Gray], SATA 6Gbps_6 connector [Light Blue])	2-26
2.	Mini-SAS HD connector (SATA1234)	2-26
3.	USB 2.0 connector (4-pin Type-A USB11)	2-27
4.	USB 3.2 Gen 1 connector (20-1 USB3_56)	2-27
5.	Fan connectors (4-pin CPU_FAN1, FRNT_FAN1-2)	2-28
6.	Serial General Purpose Input/Output connector (6-pin SGPIO1)	2-28
7.	Trusted Platform Module connector (14-pin TPM1)	2-29
8.	Power Supply SMBus connector (5-pin PSUSMB1)	2-29
9.	M.2 (NGFF) connector (NGFF1, NGFF2)	2-30
10.	Chassis Intrusion (2-pin INTRUSION)	2-30
11.	ATX power connectors (24-pin EATXPWR1, 4-pin EATX12V1)	2-31
12.	Hard disk activity LED connector (4-pin HDLED1)	2-31
13.	System panel connector (20-pin PANEL1)	2-32
14.	Auxiliary panel connector (20-pin AUX_PANEL1)	2-33
15.	Serial port connector (10-pin COM1)	2-34
16.	System Management Bus (SMBUS) connector (5-pin SMBUS1)	2-34
17.	Buzz connector (4-pin BUZZ1)	2-35
18.	Thermal sensor cable connector (3-pin TR1)	2-35
19.	Power switch connector (2-pin PWR_SW1)	2-36

2.3 Central Processing Unit (CPU)

The motherboard comes with a surface mount LGA1151 socket designed for the Intel® Xeon® processor E-21xxx / E-22xx product family and Intel® 8th/9th Generation Core™ i3 processor.



- Upon purchase of the motherboard, ensure that the PnP cap is on the socket and the socket contacts are not bent. Contact your retailer immediately if the PnP cap is missing, or if you see any damage to the PnP cap/socket contacts/motherboard components. ASUS will shoulder the cost of repair only if the damage is shipment/transit-related.
- The product warranty does not cover damage to the socket contacts resulting from incorrect CPU installation/removal, or misplacement/loss/incorrect removal of the PnP cap.

2.3.1 Installing the CPU

To install the CPU:

1. Locate the CPU socket on the motherboard.

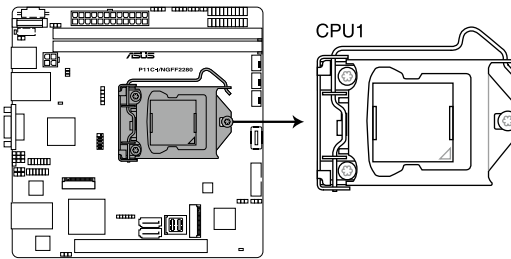

P11C-I/ NGFF2280 CPU LGA1151



Before installing the CPU, ensure that the socket box is facing toward you and the load lever is on your right.

2. Press the load lever with your thumb (A), then move it to the right (B) until it is released from the retention tab.



Do not remove the PnP cap yet from the CPU socket. Doing so may bend the pins of the socket.

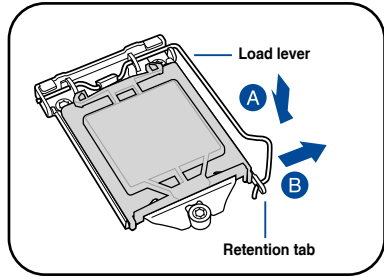

3. Lift the load lever until the load plate is completely lifted.

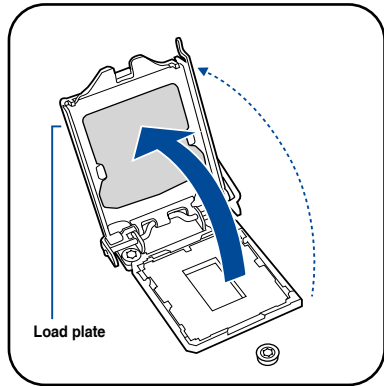

4. Position the CPU above the socket, ensuring that the gold triangle mark is on the bottom-left corner of the socket, then fit the CPU notches to the socket's alignment keys.



The CPU fits in only one orientation. DO NOT force the CPU into the socket to prevent bending the pins on the socket and damaging the CPU.

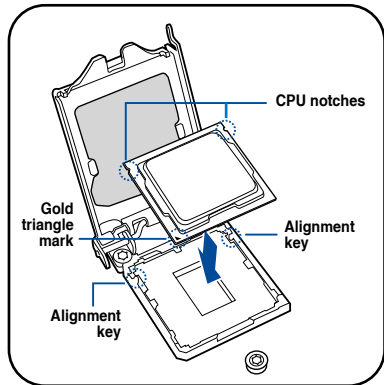

5. Close the load plate (A), ensuring that the front edge of the load plate slides under the retention lock (B) then push down the load lever (C).

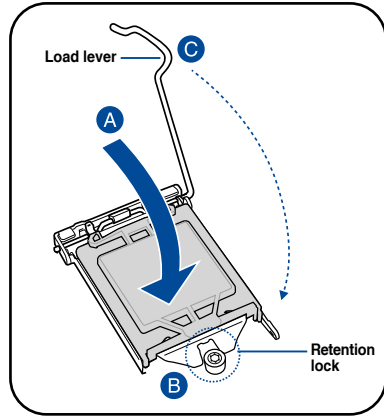

6. Insert the load lever under the retention tab to remove the PnP cap from the CPU socket.

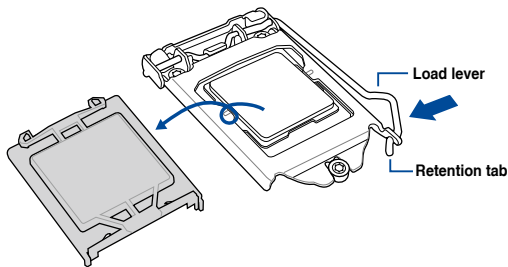

7. Apply some Thermal Interface Material to the exposed area of the CPU that the heatsink will be in contact with, ensuring that it is evenly spread in a thin layer.



Some heatsinks come with pre-applied Thermal Interface Material. If so, skip this step.



The Thermal Interface Material is toxic and inedible. DO NOT eat it. If it gets into your eyes or touches your skin, wash it off immediately and seek professional medical help.

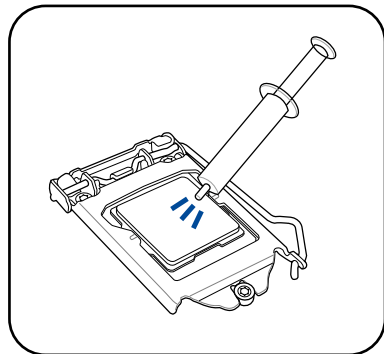

2.3.2 Installing the CPU heatsink

The Intel® LGA1151 processor requires a specially designed CPU heatsink to ensure optimum thermal condition and performance.



- When you buy a boxed Intel® processor, a specially designed CPU heatsink or a CPU heatsink with a CPU fan assembly is included depending on the package. If you buy a CPU separately, ensure that you use only Intel® certified multi-directional CPU heatsink or CPU heatsink with CPU fan.
- Use an LGA1151-compatible CPU heatsink and CPU fan assembly only. The LGA1151 socket is incompatible with the LGA775 and LGA1366 sockets in size and dimension.



If you purchased a separate CPU heatsink and fan assembly, ensure that the Thermal Interface Material is properly applied to the CPU heatsink or CPU before you install the heatsink and fan assembly.



Ensure that you have installed the motherboard to the chassis before you install the CPU fan and heatsink assembly.

To install the CPU heatsink and fan:

1. Place the heatsink on top of the installed CPU, making sure that the four fasteners match the holes on the motherboard.
2. Push down two fasteners at a time in a diagonal sequence to secure the heatsink and fan assembly in place.

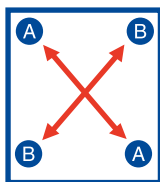
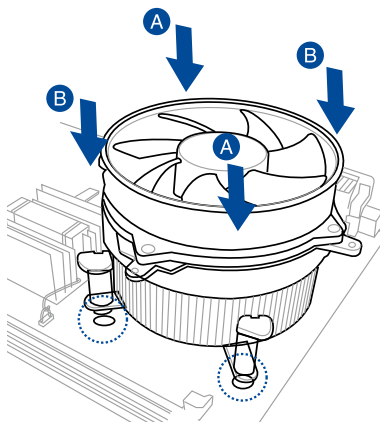

Orient the heatsink and fan assembly such that the CPU fan cable is closest to the CPU fan connector.

3. Connect the CPU fan cable to the connector on the motherboard labeled **CPU_FAN1**.



DO NOT forget to connect the CPU fan connector! Hardware monitoring errors can occur if you fail to plug this connector.

2.3.3 Uninstalling the CPU heatsink and fan

To uninstall the CPU heatsink and fan:

1. Disconnect the CPU fan cable from the connector on the motherboard.
2. Rotate each fastener counterclockwise.
3. Pull up two fasteners at a time in a diagonal sequence to disengage the heatsink and fan assembly from the motherboard.

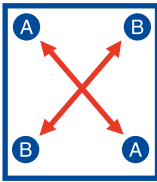
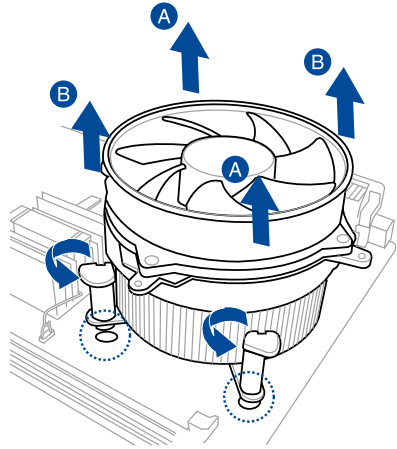

4. Carefully remove the heatsink and fan assembly from the motherboard.

2.3.4 Installing the CPU heatsink in rack

The Intel® LGA1151 processor requires a specially designed heatsink to ensure optimum thermal condition and performance.



- Ensure that you use qualified heatsink assembly only.
- Ensure that you have applied the thermal interface material to the top of the CPU before installing the heatsink and fan.

1. Peel off the sticker on the heatsink metal plate and affix the plate to the back of the motherboard, matching the standoffs to the heatsink screw holes.

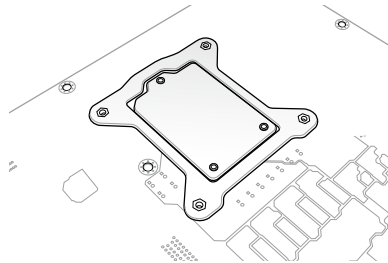

2. Use a Phillips screwdriver to tighten the four heatsink screws using the recommended sequence below.

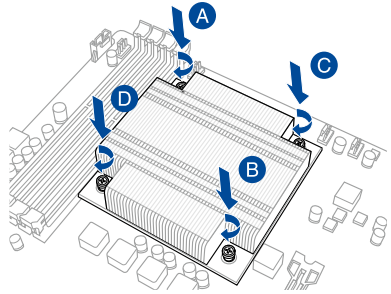
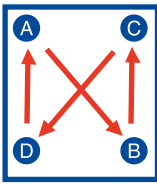

-
- Ensure that the heatsink is not skewed or tilted, otherwise the CPU will overheat.
 - Do not overtighten the screws. Doing so can damage the CPU.
-

2.4 System memory

2.4.1 Overview

The motherboard comes with two (2) Double Data Rate 4 (DDR4) Dual Inline Memory Modules (DIMM) sockets.



A DDR4 module is notched differently from a DDR, DDR2, or DDR3 module. DO NOT install a DDR, DDR2, or DDR3 memory module to the DDR4 slot.

The figure illustrates the location of the DDR4 DIMM sockets:

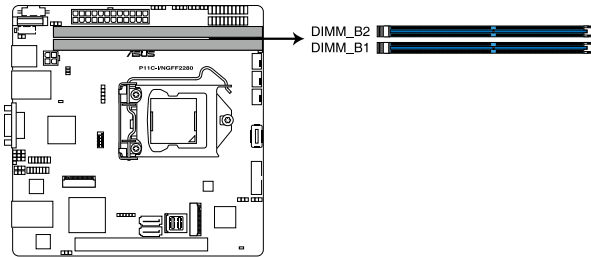

P11C-I/ NGFF2280 288-pin DDR4 DIMM sockets

2.4.2 Memory configurations

You may install Unbuffered DDR4 DIMMs into the DIMM sockets using the memory configurations in this section.

UDIMM				
DIMM Slot Per Channel	DIMM Populated per Channel	DIMM Type	Speed	Rank per DIMM
1	1	Unbuffered DDR4	2666/2400	Single Rank, Dual Rank



Always install DIMMs with the same CAS latency. For optimum compatibility, it is recommended that you obtain memory modules from the same vendor.

2.4.3 Installing a DIMM on a single clip DIMM socket

1. Unlock a DIMM socket by pressing the retaining clip outward.
2. Align a DIMM on the socket such that the notch on the DIMM matches the DIMM slot key on the socket.

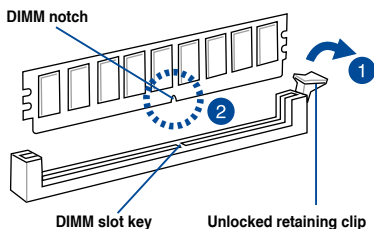

A DIMM is keyed with a notch so that it fits in only one direction. DO NOT force a DIMM into a socket in the wrong direction to avoid damaging the DIMM.

3. Hold the DIMM by both of its ends then insert the DIMM vertically into the socket. Apply force to both ends of the DIMM simultaneously until the retaining clip snaps back into place and the DIMM cannot be pushed in any further to ensure proper sitting of the DIMM.

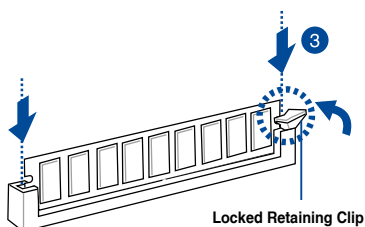

Always insert the DIMM into the socket vertically to prevent DIMM notch damage.



To install two or more DIMMs, refer to the user guide bundled in the motherboard package.

Removing a DIMM from a single clip DIMM socket

1. Press the retaining clip outward to unlock the DIMM.
2. Remove the DIMM from the socket.

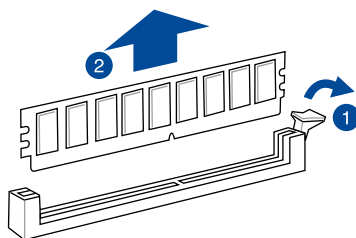

Support the DIMM lightly with your fingers when pressing the retaining clips. The DIMM might get damaged when it flips out with extra force.

2.5 Expansion slots

In the future, you may need to install expansion cards. The following subsections describe the slots and the expansion cards that they support.



Ensure to unplug the power cord before adding or removing expansion cards. Failure to do so may cause you physical injury and damage motherboard components.

2.5.1 Installing an expansion card

To install an expansion card:

1. Before installing the expansion card, read the documentation that came with it and make the necessary hardware settings for the card.
2. Remove the system unit cover (if your motherboard is already installed in a chassis).
3. Remove the bracket opposite the slot that you intend to use. Keep the screw for later use.
4. Align the card connector with the slot and press firmly until the card is completely seated on the slot.
5. Secure the card to the chassis with the screw you removed earlier.
6. Replace the system cover.

2.5.2 Configuring an expansion card

After installing the expansion card, configure it by adjusting the software settings.

1. Turn on the system and change the necessary BIOS settings, if any. See Chapter 4 for information on BIOS setup.
2. Assign an IRQ to the card. Refer to the tables on the next page.
3. Install the software drivers for the expansion card.



When using PCI cards on shared slots, ensure that the drivers support "Share IRQ" or that the cards do not need IRQ assignments. Otherwise, conflicts will arise between the two PCI groups, making the system unstable and the card inoperable.

2.5.3 Interrupt assignments

Standard Interrupt assignments

IRQ	Priority	Standard function
0	1	System Timer
1	2	Keyboard Controller
2	-	Programmable Interrupt
3*	-	--
4*	9	Communications Port (COM1)
5*	10	Print Port (LPT1)
6	-	--
7*	-	--
8	3	System CMOS/Real Time Clock
9*	4	ACPI Mode when used
10*	5	IRQ Holder for PCI Steering
11*	6	IRQ Holder for PCI Steering
12*	7	PS/2 Compatible Mouse Port
13	8	Numeric Data Processor
14*	-	--
15*	-	--

* These IRQs are usually available for ISA or PCI devices.

2.5.4 PCI Express x16 slot (x16 Gen3 link)

The onboard PCIE 1 provides one x16 Gen3 link to CPU. This slot supports VGA cards and various server class high performance add-on cards.

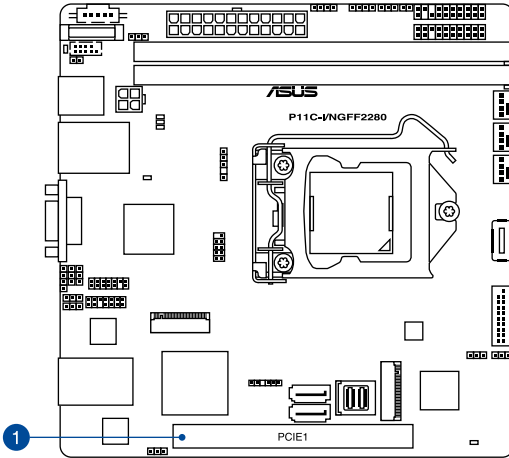

No.(Slot location)	Short Description	
1	PCI E1	1 x PCI-E x16 (x16 Gen3 link)

2.5.5 Installing the Baseboard Management Card

Follow the steps below to install an optional ASMB9 Management Card on your motherboard.

1. Locate the Baseboard Management Card header on the motherboard.

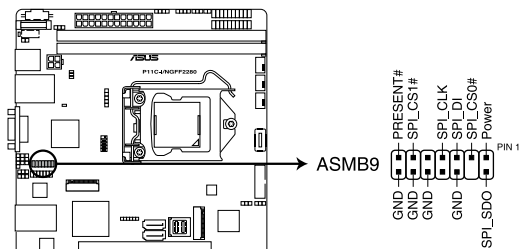

P11C-IV NGFF2280 BMC connector

2. Orient and press the Management Card in place.

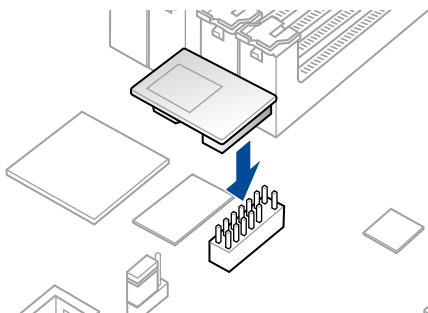

The motherboard illustration is for reference only. The motherboard layout and appearance may vary depending on the model, but the installation steps remain the same.

2.6 Onboard LEDs

1. Standby Power LED (SBPWR1)

The motherboard comes with a standby power LED. The green LED lights up to indicate that the system is ON, in sleep mode, or in soft-off mode. This is a reminder that you should shut down the system and unplug the power cable before removing or plugging in any motherboard component. The illustration below shows the location of the onboard LED.

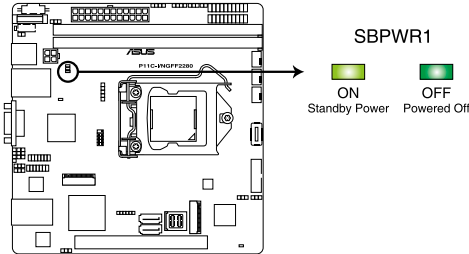

P11C-I/ NGFF2280 Standby Power LED

2. CATT ERR LED (CATTERR1)

The CATT ERR LED indicates that the system has experienced a fatal or catastrophic error and cannot continue to operate.

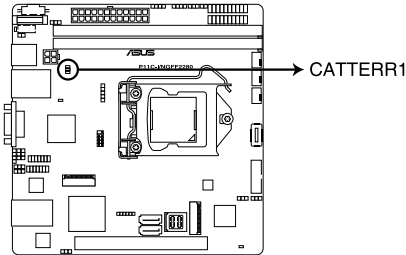

P11C-I/ NGFF2280 CATTERR1 LED

3. Baseboard Management Controller LED (BMCLED1)

The green heartbeat LED blinks per second to indicate that the ASMB9 is working normally. The BMC LED works with the ASUS ASMB9 management device and indicates its initiation status. When the PSU is plugged and the system is OFF, ASUS ASMB9 management device starts system initiation for about one (1) minute. The BMC LED blinks after system initiation finishes.

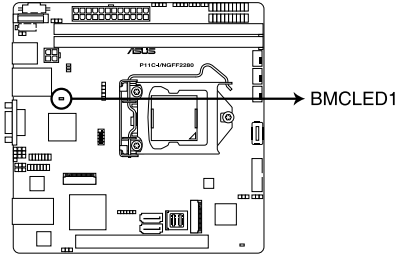

P11C-I/ NGFF2280 BMC LED



- The heartbeat LED functions only when you install the ASUS ASMB9 Management card.
- Every time after the AC power is replugged you have to wait for about 60 seconds for the system to power on.

4. CPU Warning LED (ERRCPU1)

The CPU warning LED lights up to indicate that a CPU error or failure has occurred.

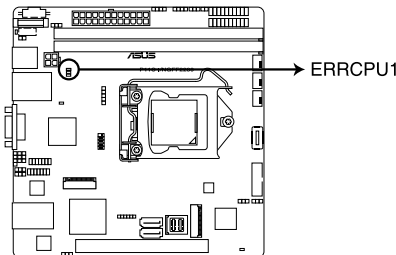

P11C-I/ NGFF2280 ERRCPU1 LED

5. ME LED (MELED1)

The ME LED is an onboard LED that blinks when the ME is operating properly.

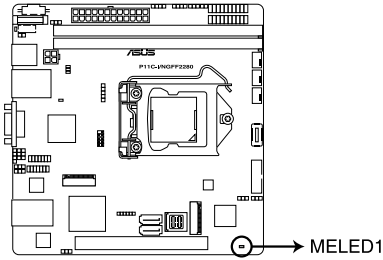

P11C-I/ NGFF2280 MELED1

2.7 Jumpers

1. Clear RTC RAM (3-pin CLRTC1)

This jumper allows you to clear the CMOS memory system setup parameters by erasing the CMOS Real Time Clock (RTC) RAM data. The onboard button cell battery powers the RAM data in CMOS, which include system setup information such as system passwords.

To erase the RTC RAM:

1. Turn OFF the computer and unplug the power cord.
2. Move the jumper cap from pins 1–2 (default) to pins 2–3. Keep the cap on pins 2–3 for about 5–10 seconds, then move the cap back to pins 1–2.
3. Plug the power cord and turn ON the computer.
4. Hold down the key during the boot process and enter BIOS setup to reenter data.



Except when clearing the RTC RAM, never remove the cap on CLRTC jumper default position. Removing the cap will cause system boot failure!



- If the steps above do not help, remove the onboard battery and short the two pins again to clear the CMOS RTC RAM data. After clearing the CMOS, reinstall the battery.
 - Due to chipset behavior, AC power off is required to enable C.P.R. function. You must turn off and on the power supply or unplug and plug the power cord before rebooting the system.
-

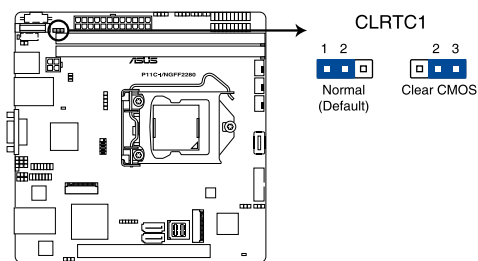

P11C-I/ NGFF2280 Clear RTC RAM

2. VGA controller setting (3-pin VGA_SW1)

This jumper allows you to enable or disable the onboard VGA controller. Set to pins 1–2 to activate the VGA feature.

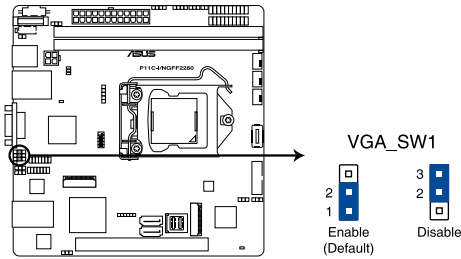

P11C-I/ NGFF2280 VGA setting

3. LAN controller setting (3-pin LAN_SW1-2)

These jumpers allow you to enable or disable the onboard Intel® I210 Gigabit LAN controllers. Set to pins 1-2 to activate the Gigabit LAN feature.

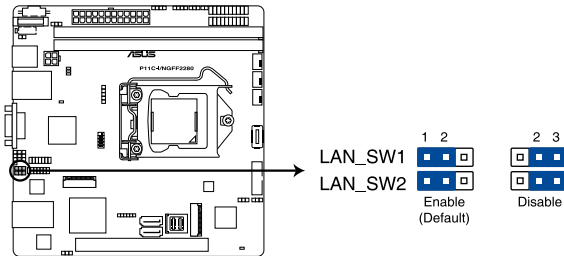

P11C-I/ NGFF2280 LAN setting

4. ME firmware force recovery setting (3-pin ME_RCVR1)

This jumper allows you to force Intel Management Engine (ME) boot from recovery mode when ME become corrupted.

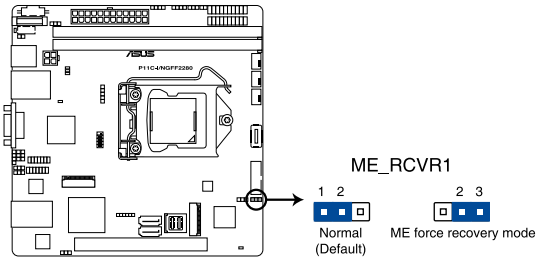

P11C-I/ NGFF2280 ME recovery setting

5. PCH_MFG1 setting (3-pin PCH_MFG1)

This jumper allows you to update the BIOS ME block select.

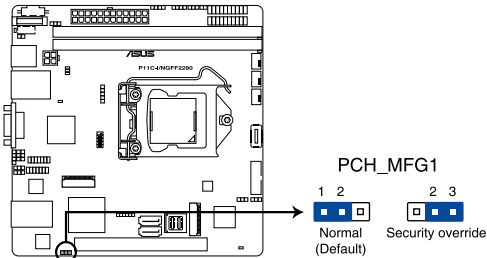

P11C-I/ NGFF2280 PCH_MFG1 setting

2.8 Connectors

2.8.1 Rear panel connectors

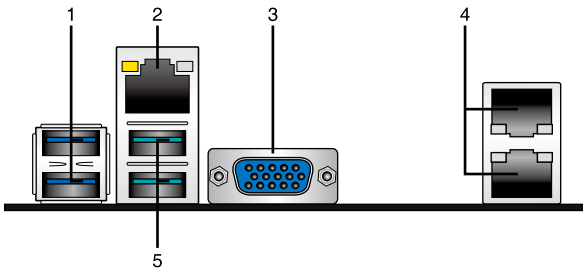

1. **USB 3.2 Gen 1 ports 3 and 4.** These two 4-pin USB ports are available for connecting USB 3.2 Gen 1 devices.
2. **RJ-45 port for iKVM.** This RJ-45 port functions only when you enable ASMB9 Management card.
3. **Video Graphics Adapter port.** This port is for a VGA monitor or other VGA-compatible devices.
4. **RJ-45 port for LAN 2.** This port allows Gigabit connection to a Local Area Network (LAN) through a network hub. Refer to the table below for the LAN port LED indications.
5. **USB 3.2 Gen 2 ports 1 and 2.** These two 4-pin USB ports are available for connecting USB 3.2 Gen 2 devices.
4. **RJ-45 port for LAN 1.** This port allows Gigabit connection to a Local Area Network (LAN) through a network hub. Refer to the table below for the LAN port LED indications.

LAN port LED indications

Activity/Link LED		Speed LED	
Status	Description	Status	Description
OFF	No link	OFF	10 Mbps connection
GREEN	Linked	ORANGE	100 Mbps connection
BLINKING	Data activity	GREEN	1 Gbps connection

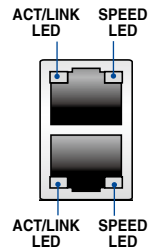

Dedicated Management LAN port (DM_LAN1) LED indications

Activity/Link LED		Speed LED	
Status	Description	Status	Description
OFF	No link	OFF	10 Mbps connection
ORANGE	Linked	ORANGE	100 Mbps connection
BLINKING	Data activity	GREEN	1 Gbps connection

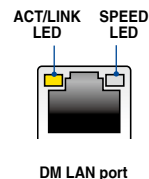

2.8.3 Internal connectors

1. Serial ATA 6.0 Gbps connectors (7-pin SATA 6Gbps_5 connector [Gray], SATA 6Gbps_6 connector [Light Blue])

Supported by the Intel® C242 chipset, these connectors are for the Serial ATA signal cables for Serial ATA hard disk drives that allows up to 6Gb/s of data transfer rate.

If you installed Serial ATA hard disk drives, you can create a RAID 0, RAID 1, RAID 10, or RAID 5 configuration.

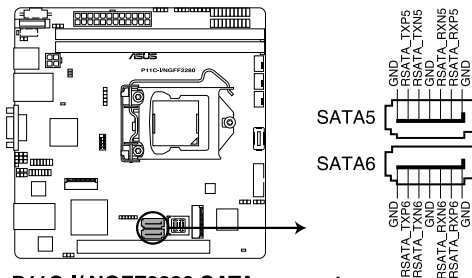

P11C-1/ NGFF2280 SATA connectors



The actual data transfer rate depends on the speed of Serial ATA hard disks installed.



When the M.2 connector is operating in SATA mode, SATA connector 5 (SATA 5 Gbps_6) will be disabled.

2. Mini-SAS HD connector (SATA1234)

This motherboard comes with one mini Serial Attached SCSI (SAS) connector, the storage technology that supports both Serial Attached SCSI and Serial ATA. Each connector supports up to four devices.

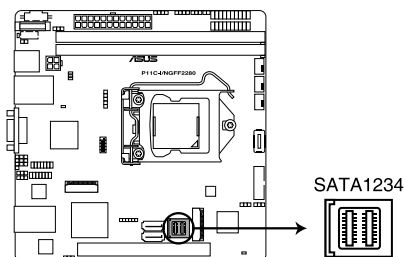

P11C-1/ NGFF2280 Mini-SAS HD Connector (SATA1234)

3. USB 2.0 connector (4-pin Type-A USB11)

The 4-pin USB (Universal Serial Bus) Type-A port is available for connecting USB 2.0 devices. The USB connector complies with USB 2.0 specification that supports up to 480 Mbps connection speed.

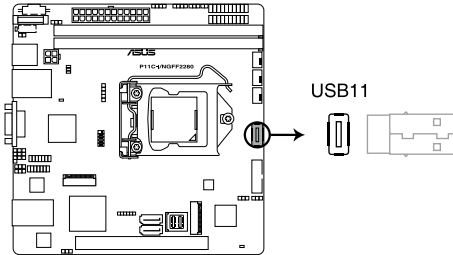

P11C-I/ NGFF2280 USB 2.0 connector

4. USB 3.2 Gen 1 connector (20-1 USB3_56)

This connector allows you to connect a USB 3.2 Gen 1 module for additional USB 3.2 Gen 1 front or rear panel ports. With an installed USB 3.2 Gen 1 module, you can enjoy all the benefits of USB 3.2 Gen 1 including faster data transfer speeds of up to 5 Gb/s, faster charging time for USB-chargable devices, optimized power efficiency, and backward compatibility with USB 2.0.

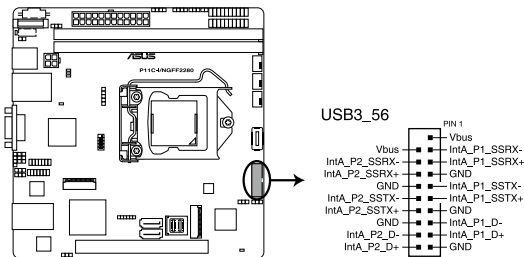

P11C-I/ NGFF2280 USB 3.0 connector

5. **Fan connectors (4-pin CPU_FAN1, FRNT_FAN1-2)**

Connect the fan cables to the fan connectors on the motherboard, ensuring that the black wire of each cable matches the ground pin of the connector.

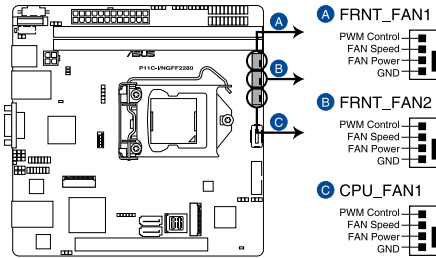

P11C-V NGFF2280 FAN connectors



- DO NOT forget to connect the fan cables to the fan connectors. Insufficient air flow inside the system may damage the motherboard components.
- These are not jumpers! DO NOT place jumper caps on the fan connectors!
- Ensure that the CPU fan cable is securely installed to the CPU fan connector.

6. **Serial General Purpose Input/Output connector (6-1 pin SGPIO1)**

The SGPIO1 connector is used for the Intel Rapid Storage Technology Enterprise SGPIO interface that controls the LED pattern generation, device information, and general purpose data.

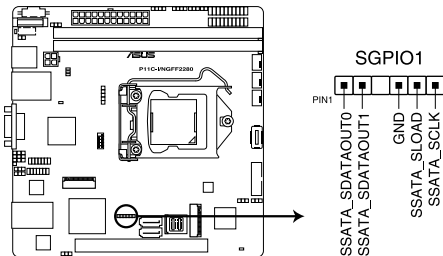

P11C-V NGFF2280 SGPIO1 connector

7. Trusted Platform Module connector (14-1 pin TPM1)

This connector supports a Trusted Platform Module (TPM) system, which can securely store keys, digital certificates, passwords, and data. A TPM system also helps enhance network security, protects digital identities, and ensures platform integrity.

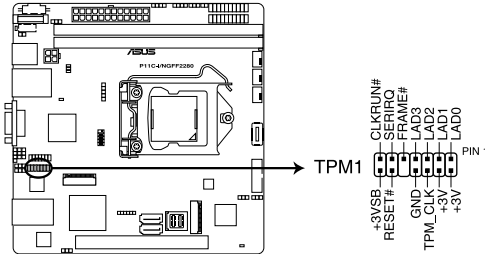

P11C-I/ NGFF2280 TPM connector

8. Power Supply SMBus connector (5-pin PSUSMB1)

This connector allows you to connect SMBus (System Management Bus) to the PSU (power supply unit) to read PSU information. Devices communicate with an SMBus host and/or other SMBus devices using the SMBus interface.

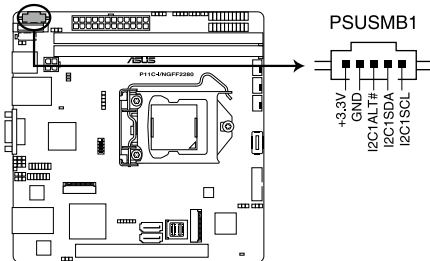

P11C-I/ NGFF2280 Power supply SMBus connector



This connector functions only when you enable the ASUS ASMB9.



Power supply is required to meet PMBus specification and customized BMC FW may be needed. Please contact ASUS if you need further support.

9. M.2 (NGFF) connector (NGFF1, NGFF2)

This connector allows you to install an M.2 device.

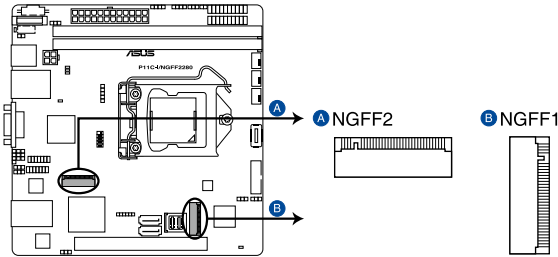

P11C-I/ NGFF2280 NGFF connector



- NGFF1 connector supports type 2242 devices on both PCI-E and SATA interface.
- NGFF2 connector supports type 2280 devices on both PCI-E and SATA interface.



- The M.2 (NGFF) device is purchased separately
- When the NGFF1 or NGFF2 is operating in SATA mode, SATA connector 5 or SATA connector 6 will be disabled.

10. Chassis Intrusion (2-pin INTRUSION)

These leads are for the intrusion detection feature for chassis with intrusion sensor or microswitch. When you remove any chassis component, the sensor triggers and sends a high level signal to these leads to record a chassis intrusion event. The default setting is short CHASSIS# and GND pin by jumper cap to disable the function.

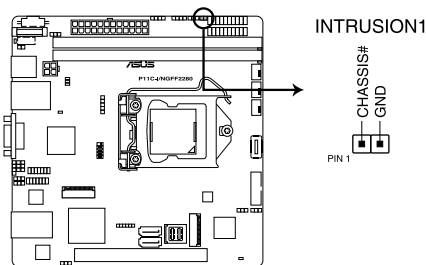

P11C-I/ NGFF2280 Chassis Intrusion connector

11. ATX power connectors (24-pin EATXPWR1, 4-pin EATX12V1)

These connectors are for the ATX power supply plugs. The power supply plugs are designed to fit these connectors in only one orientation. Find the proper orientation and push down firmly until the connectors completely fit.

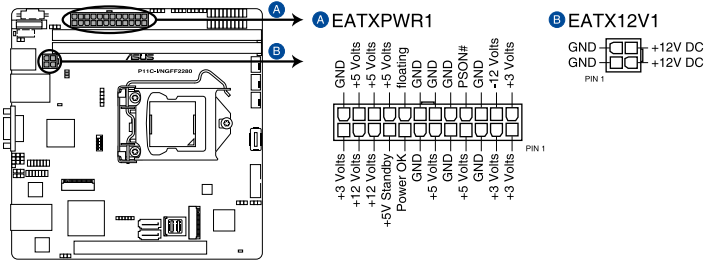

P11C-I/ NGFF2280 ATX power connectors



- DO NOT forget to connect the 24-pin and the 4-pin power plugs; otherwise, the system will not boot up.
- Use of a power supply unit (PSU) with a higher power output is recommended when configuring a system with more power-consuming devices. The system may become unstable or may not boot up if the power is inadequate.
- This motherboard supports ATX2.0 PSU or later version.
- Ensure that your PSU can provide at least the minimum power required by your system.

12. Hard disk activity LED connector (4-pin HDLED1)

This LED connector is for the storage add-on card cable connected to the SATA or SAS add-on card. The read or write activities of any device connected to the SATA or SAS add-on card causes the front panel LED to light up.

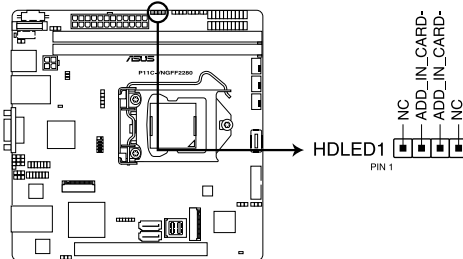

P11C-I/ NGFF2280 Storage device activity LED connector

13. System panel connector (20-1 pin PANEL1)

This connector supports several chassis-mounted functions.

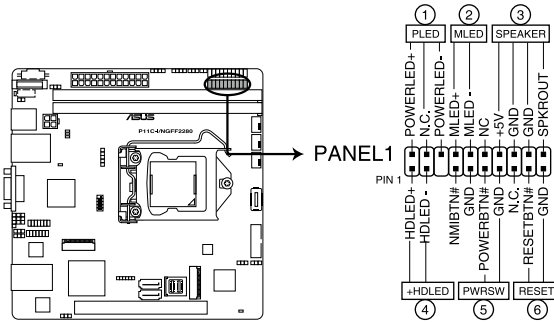

P11C-I/ NGFF2280 System panel connector

- **System power LED (3-pin PLED)**
This 3-pin connector is for the system power LED. Connect the chassis power LED cable to this connector. The system power LED lights up when you turn on the system power, and blinks when the system is in sleep mode.
- **Message LED (2-pin MLED)**
This 2-pin connector is for the message LED cable that connects to the front message LED. The message LED is controlled by Hardware monitor to indicate an abnormal event occurrence.
- **System warning speaker (4-pin SPEAKER)**
This 4-pin connector is for the chassis-mounted system warning speaker. The speaker allows you to hear system beeps and warnings.
- **Hard disk drive activity LED (2-pin +HDLED)**
This 2-pin connector is for the HDD Activity LED. Connect the HDD Activity LED cable to this connector. The IDE LED lights up or flashes when data is read from or written to the HDD.
- **Power button/soft-off button (2-pin PWRSW)**
This connector is for the system power button. Pressing the power button turns the system on or puts the system in sleep or soft-off mode depending on the BIOS settings. Pressing the power switch for more than four (4) seconds while the system is ON turns the system OFF.
- **Reset button (2-pin RESET)**
This 2-pin connector is for the chassis-mounted reset button for system reboot without turning off the system power.

14. Auxiliary panel connector (20-2 pin AUX_PANEL1)

This connector is for additional front panel features including front panel SMB, locator LED and switch, chassis intrusion, and LAN LEDs.

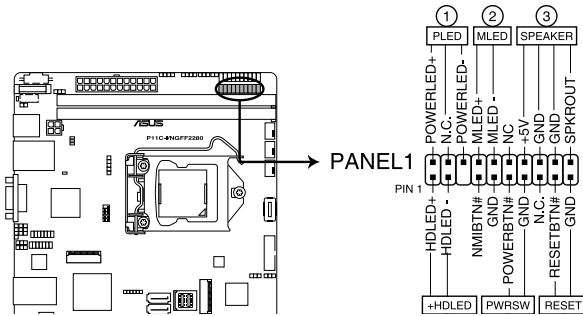

- **Front panel SMB (6-1 pin FPSMB)**

These connectors connect the front panel SMBus cable.

- **Locator LED (2-pin AUX_LOCLE1 and 2-pin AUX_LOCLE2)**

These connectors are for the Locator LED1 and LED2 on the front panel. Connect the Locator LED cables to these 2-pin connectors. The LEDs will light up when the Locator button is pressed.

- **Locator Button/Switch (2-pin AUX_BMCLOCBNT)**

These connectors are for the locator button on the front panel. This button queries the state of the system locator.

15. Serial port connector (10-1 pin COM1)

This connector is for the serial COM port. Connect the serial port module cable to one of these connectors, then install the module to a slot opening at the back of the system chassis.

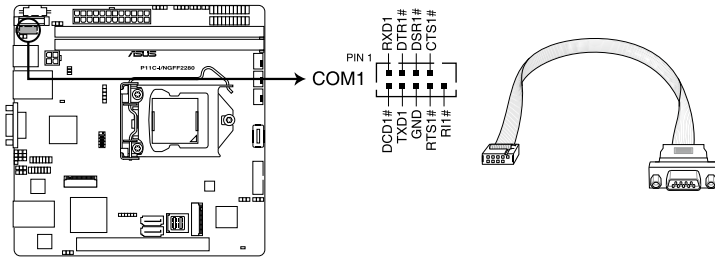

P11C-I/ NGFF2280 Serial port connector



Ensure to connect the COM port cable to the serial port connector (COM1) to use the serial COM port.

16. System Management Bus (SMBUS) connector (5-1 pin SMBUS1)

This connector controls the system and power management-related tasks. This connector processes the messages to and from devices rather than tripping the individual control lines.

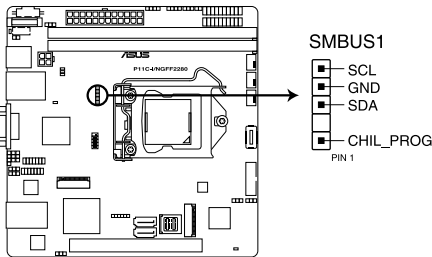

P11C-I/ NGFF2280 SMBUS connector

17. Buzz connector (4-pin BUZZ1)

This connector allows you to connect a speaker or a buzzer.

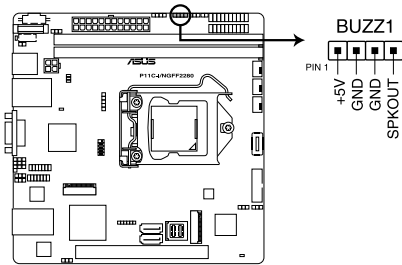

P11C-I/ NGFF2280 BUZZ1 connector

18. Thermal sensor cable connector (3-pin TR1)

This connector allows you to connect a thermal sensor cable that is used for monitoring temperature. Connect the thermal sensor cable to the connector and place its probe to the device that you want to monitor.

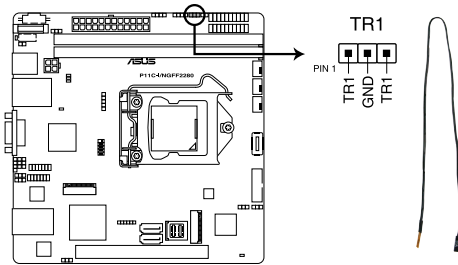

P11C-I/ NGFF2280 Thermal sensor cable connector

19. Power switch connector (2-pin PWR_SW1)

This connector allows you to connect a power switch.

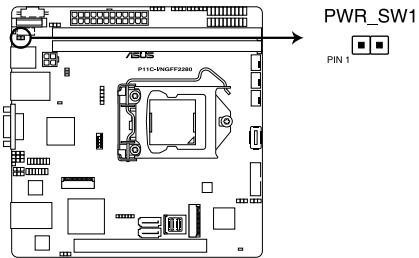

P11C-I/ NGFF280 PWR_SW1

Chapter 3: Powering Up

3.1 Starting up for the first time

1. After making all the connections, replace the system case cover.
2. Be sure that all switches are off.
3. Connect the power cord to the power connector at the back of the system chassis.
4. Connect the power cord to a power outlet that is equipped with a surge protector.
5. Turn on the devices in the following order:
 - a. Monitor
 - b. External storage devices (starting with the last device on the chain)
 - c. System power
6. After applying power, the system power LED on the system front panel case lights up. For systems with ATX power supplies, the system LED lights up when you press the ATX power button. If your monitor complies with “green” standards or if it has a “power standby” feature, the monitor LED may light up or switch between orange and green after the system LED turns on.

The system then runs the power-on self-test or POST. While the tests are running, the BIOS beeps or additional messages appear on the screen. If you do not see anything within 30 seconds from the time you turned on the power, the system may have failed a power-on test. Check the jumper settings and connections or call your retailer for assistance.

The following shows the possible beep codes and its corresponding error condition

BIOS Beep codes	
Beep	Error condition
1 short	Power supply surges detected during the previous power on.
1 short	No Keyboard Detected.
1 short, 2 short	No DIMM Detected.
1 short, 8 short	No VGA Detected.
2 long	Chassis Intrusion.
2 long	BIOS-image Crash Detected.

7. At power on, hold down the key to enter the BIOS Setup. Follow the instructions in Chapter 4.

3.2 Powering off the computer

3.2.1 Using the OS shut down function

Using Windows® Server 2016 or Windows® Server 2019:

1. Press <Alt>+<F4>.
2. In the *What do you want the computer to do?*, select **Shut down**.
3. In the *Shutdown Event Tracker*, select the **Other (Planned)** option in the selection list. Otherwise, select the option that best describes why you want to shut down the computer.
4. Click **OK**.

3.2.2 Using the dual function power switch

While the system is ON, press the power switch for less than four (4) seconds to put the system to sleep mode or to soft-off mode, depending on the BIOS setting.



Pressing the power switch for more than four (4) seconds lets the system enter the soft-off mode regardless of the BIOS setting.

Chapter 4: BIOS Setup

4.1 Managing and updating your BIOS

The following utilities allow you to manage and update the motherboard Basic Input/Output System (BIOS) setup:

1. **ASUS CrashFree BIOS 3**

To recover the BIOS using a bootable USB flash disk drive when the BIOS file fails or gets corrupted.

2. **ASUS EzFlash**

Updates the BIOS using a USB flash disk.

3. **BUPDATER**

Updates the BIOS in DOS mode using a bootable USB flash disk drive.

Refer to the corresponding sections for details on these utilities.



Save a copy of the original motherboard BIOS file to a bootable USB flash disk drive in case you need to restore the BIOS in the future. Copy the original motherboard BIOS using the BUPDATER utility.

4.1.1 **ASUS CrashFree BIOS 3 utility**

The ASUS CrashFree BIOS 3 is an auto recovery tool that allows you to restore the BIOS file when it fails or gets corrupted during the updating process. You can update a corrupted BIOS file using a USB flash drive that contains the updated BIOS file.



Prepare a USB flash drive containing the updated motherboard BIOS before using this utility.



When downloading or updating the BIOS file, rename it as **P10SI.CAP** for this motherboard.

Recovering the BIOS from a USB flash drive

To recover the BIOS from a USB flash drive:

1. Insert the USB flash drive with the original or updated BIOS file to one USB port on the system.
2. The utility will automatically recover the BIOS. It resets the system when the BIOS recovery finished.



DO NOT shut down or reset the system while recovering the BIOS! Doing so would cause system boot failure!



The recovered BIOS may not be the latest BIOS version for this motherboard. Visit the ASUS website at www.asus.com to download the latest BIOS file.

4.1.2 ASUS EzFlash Utility

The ASUS EzFlash Utility feature allows you to update the BIOS using a USB flash disk without having to use a DOS-based utility.



Download the latest BIOS from the ASUS website at www.asus.com before using this utility.



The succeeding BIOS screens are for reference only. The actual BIOS screen displays may not be the same as shown.

To update the BIOS using EzFlash Utility:

1. Insert the USB flash disk that contains the latest BIOS file to the USB port.
2. Enter the BIOS setup program. Go to the **Tool** menu to select **ASUS EzFlash Utility** and press <Enter> to enable it.

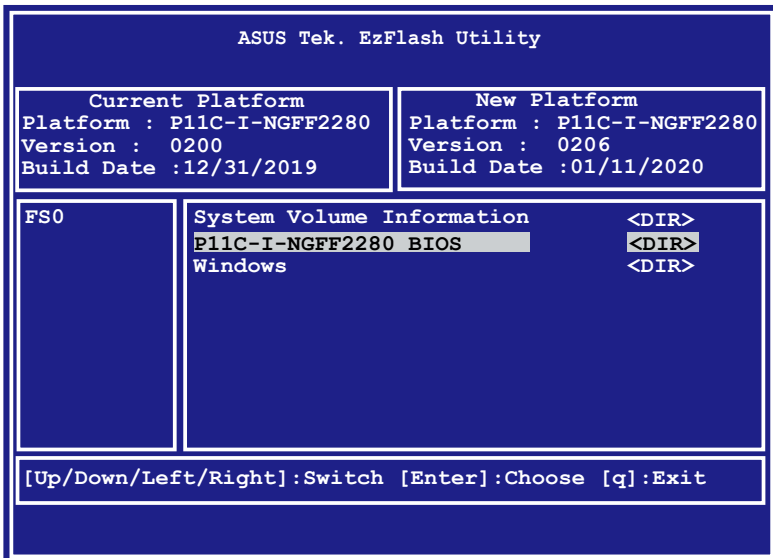

3. Press <Tab> to switch to the **Drive** field.
4. Press the Up/Down arrow keys to find the USB flash disk that contains the latest BIOS then press <Enter>.
5. Press <Tab> to switch to the **Folder Info** field.
6. Press the Up/Down arrow keys to find the BIOS file then press <Enter>.
7. Reboot the system when the update process is done.



-
- This function can support devices such as a USB flash disk with FAT 32/16 format and single partition only.
 - DO NOT shut down or reset the system while updating the BIOS to prevent system boot failure!
-



Ensure to load the BIOS default settings to ensure system compatibility and stability. Press <F5> and select **Yes** to load the BIOS default settings.

4.1.3 BUPDATER utility



The succeeding BIOS screens are for reference only. The actual BIOS screen displays may not be the same as shown.

The BUPDATER utility allows you to update the BIOS file in DOS environment using a bootable USB flash disk drive with the updated BIOS file.

Updating the BIOS file

To update the BIOS file using the BUPDATER utility:

1. Visit the ASUS website at www.asus.com and download the latest BIOS file for the motherboard. Save the BIOS file to a bootable USB flash disk drive.
2. Download the BUPDATER utility (BUPDATER.exe) from the ASUS support website at www.asus.com/support to the bootable USB flash disk drive you created earlier.
3. Boot the system in DOS mode, then at the prompt, type:

```
BUPDATER /i[filename].CAP
```

where [filename] is the latest or the original BIOS file on the bootable USB flash disk drive, then press <Enter>.

```
A:\>BUPDATER /i[file name]CAP
```

The utility verifies the file, then starts updating the BIOS file.

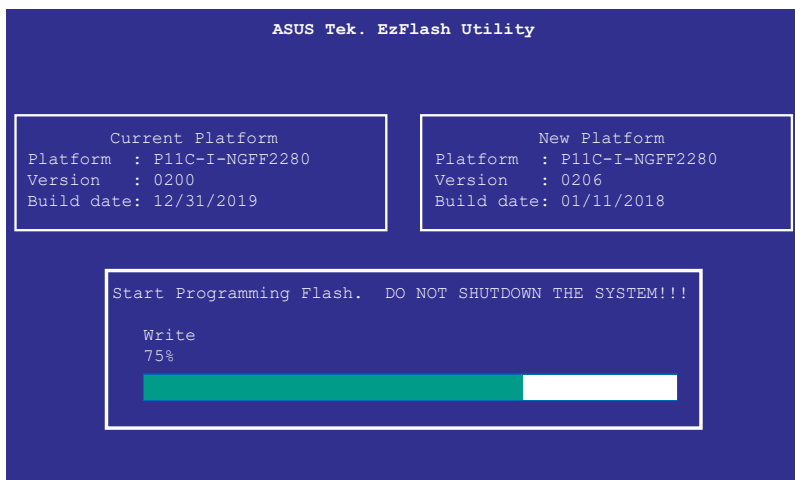

DO NOT shut down or reset the system while updating the BIOS to prevent system boot failure!

The utility returns to the DOS prompt after the BIOS update process is completed.

4. Reboot the system from the hard disk drive.

```
The BIOS update is finished! Please restart your system.  
C:\>
```

4.2 BIOS setup program

This motherboard supports a programmable firmware chip that you can update using the provided utility described in section 4.1 **Managing and updating your BIOS**.

Use the BIOS Setup program when you are installing a motherboard, reconfiguring your system, or prompted to “Run Setup.” This section explains how to configure your system using this utility.

Even if you are not prompted to use the Setup program, you can change the configuration of your computer in the future. For example, you can enable the security password feature or change the power management settings. This requires you to reconfigure your system using the BIOS Setup program so that the computer can recognize these changes and record them in the CMOS RAM of the firmware chip.

The firmware chip on the motherboard stores the Setup utility. When you start up the computer, the system provides you with the opportunity to run this program. Press during the Power-On Self-Test (POST) to enter the Setup utility; otherwise, POST continues with its test routines.

If you wish to enter Setup after POST, restart the system by pressing <Ctrl>+<Alt>+, or by pressing the reset button on the system chassis. You can also restart by turning the system off then back on. Do this last option only if the first two failed.

The Setup program is designed to make it as easy to use as possible. Being a menu-driven program, it lets you scroll through the various sub-menus and make your selections from the available options using the navigation keys.



-
- The default BIOS settings for this motherboard apply for most conditions to ensure optimum performance. If the system becomes unstable after changing any BIOS settings, load the default settings to ensure system compatibility and stability. Press <F5> and select **Yes** to load the BIOS default settings.
 - The BIOS setup screens shown in this section are for reference purposes only, and may not exactly match what you see on your screen.
 - Visit the ASUS website (www.asus.com) to download the latest BIOS file for this motherboard.
-

4.2.1 BIOS menu screen

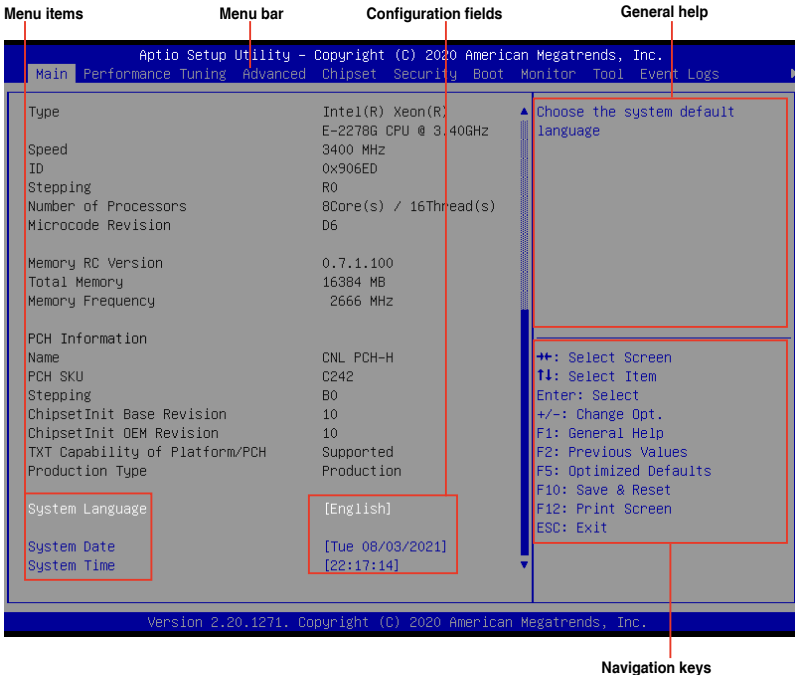

4.2.2 Menu bar

The menu bar on top of the screen has the following main items:

- | | |
|---------------------------|--|
| Main | For changing the basic system configuration |
| Performance Tuning | For changing the performance settings |
| Advanced | For changing the advanced system settings |
| Chipset | For changing the chipset settings |
| Security | For changing the security settings |
| Boot | For changing the system boot configuration |
| Monitor | For displaying the system temperature, power status, and changing the fan settings |
| Tool | For configuring options for special functions |
| Event Logs | For changing the event log settings |
| Server Mgmt | For changing the server mgmt settings |
| Save & Exit | For selecting the save & exit options |

To select an item on the menu bar, press the right or left arrow key on the keyboard until the desired item is highlighted.

4.2.3 Menu items

The highlighted item on the menu bar displays the specific items for that menu. For example, selecting **Main** shows the Main menu items. The other items (Performance Tuning, Advanced, Chipset, Security, Boot, Monitor, Tool, Event Logs, Server Mgmt, and Save & Exit) on the menu bar have their respective menu items.

4.2.4 Submenu items

A solid triangle before each item on any menu screen means that the item has a submenu. To display the submenu, select the item and press <Enter>.

4.2.5 Navigation keys

At the bottom right corner of a menu screen are the navigation keys for the BIOS setup program. Use the navigation keys to select items in the menu and change the settings.

4.2.6 General help

At the top right corner of the menu screen is a brief description of the selected item.

4.2.7 Configuration fields

These fields show the values for the menu items. If an item is user-configurable, you can change the value of the field opposite the item. You cannot select an item that is not user-configurable. A configurable field is enclosed in brackets, and is highlighted when selected. To change the value of a field, select it and press <Enter> to display a list of options.

4.2.8 Pop-up window

Select a menu item and press <Enter> to display a pop-up window with the configuration options for that item.

4.2.9 Scroll bar

A scroll bar appears on the right side of a menu screen when there are items that do not fit on the screen. Press the Up/Down arrow keys or <Page Up> /<Page Down> keys to display the other items on the screen.

4.3 Main menu

When you enter the BIOS Setup program, the Main menu screen appears. The Main menu provides you an overview of the basic system information, and allows you to set the system date and time.

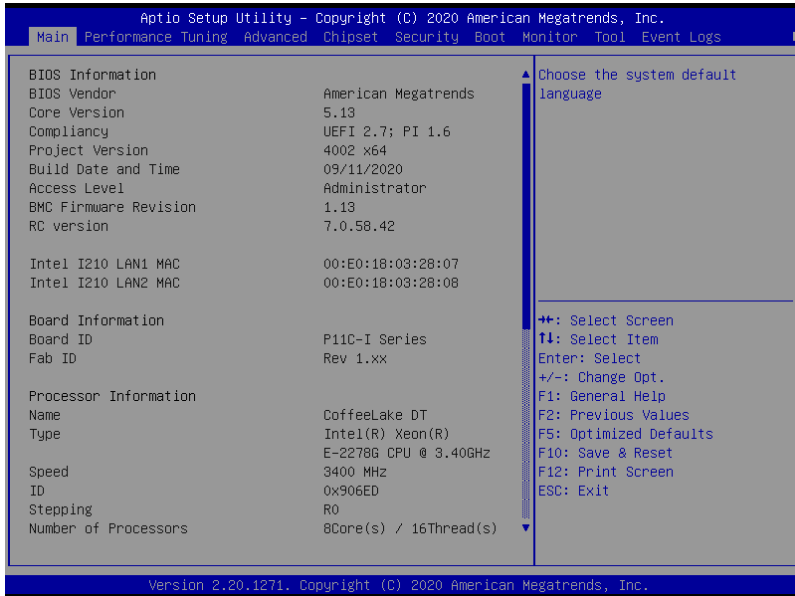

Navigate to the second page of the screen to see the rest of items in this menu by pressing the Up or Down arrow keys.



To quickly go to the last item of the second page, press the **Page Down** button. Press the **Page Up** button to go back to the first item in the first page.

System Date [Day MM/DD/YYYY]

Allows you to set the system date.

System Time [HH:MM:SS]

Allows you to set the system time.

4.4 Performance Tuning menu

The Performance Tuning menu items allow you to change performance related settings for different scenarios.

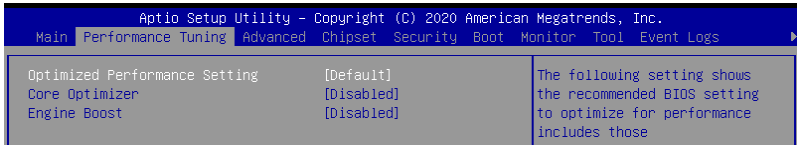

Optimized Performance Setting [Default]

Allows you to select performance settings for different scenarios.

[Default] Default settings.

[By Benchmark] Optimize for different kinds of benchmarks. Select this option, then select a benchmark type from the >> list.

Core Optimizer [Disabled]

Enable this item to keep the processor operating at the turbo frequency.

Configuration options: [Disabled] [Enabled]



Linux support may vary by version of the OS.

Engine Boost [Disabled]

Enable this item to boost the CPU's frequency.

Configuration options: [Disabled] [Level1] [Level2] [Level3(Max)]

4.5 Advanced menu

The Advanced menu items allow you to change the settings for the CPU and other system devices.



Take caution when changing the settings of the Advanced menu items. Incorrect field values can cause the system to malfunction.

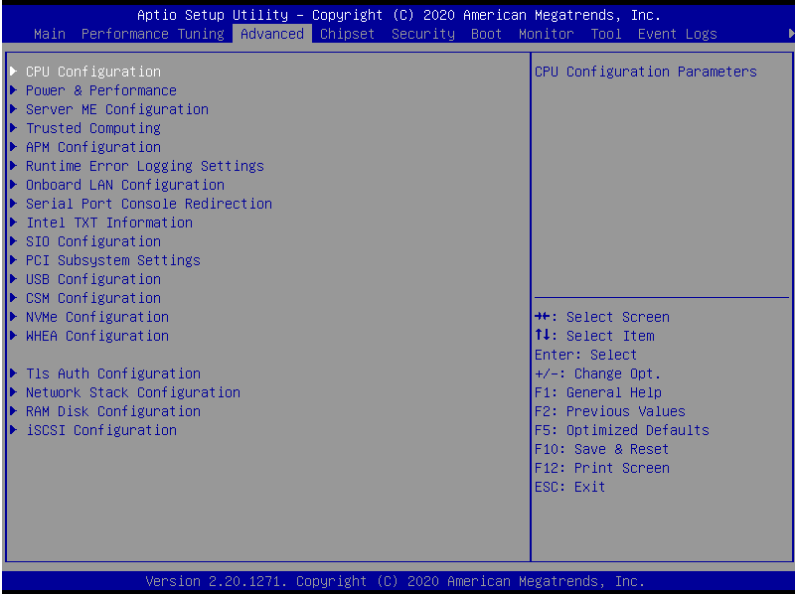

4.5.1 CPU Configuration

The screenshot shows the Aptio Setup Utility BIOS interface. At the top, it says "Aptio Setup Utility - Copyright (C) 2020 American Megatrends, Inc." and "Advanced". The main area is titled "CPU Configuration" and lists various settings for an Intel(R) Xeon(R) E-2278G CPU @ 3.40GHz. The settings include Type, ID, Speed, L1 Data Cache, L1 Instruction Cache, L2 Cache, L3 Cache, L4 Cache, VMX, and SMX/TXT. Below this, there are settings for C6DRAM, Software Guard Extensions (SGX), and Select Owner EPOCH input type. The C6DRAM setting is currently [Enabled]. The SGX setting is [Software Controlled]. The Select Owner EPOCH input type is [No Change in Owner EPOCHs]. On the right side, there is a help menu with options like "++: Select Screen", "F1: Select Item", "Enter: Select", "+/-: Change Opt.", "F1: General Help", "F2: Previous Values", "F5: Optimized Defaults", "F10: Save & Reset", "F12: Print Screen", and "ESC: Exit".

Setting	Value
Type	Intel(R) Xeon(R) E-2278G CPU @ 3.40GHz
ID	0x906ED
Speed	3400 MHz
L1 Data Cache	32 KB x 8
L1 Instruction Cache	32 KB x 8
L2 Cache	256 KB x 8
L3 Cache	16 MB
L4 Cache	N/A
VMX	Supported
SMX/TXT	Supported
C6DRAM	[Enabled]
Software Guard Extensions (SGX)	[Software Controlled]
Select Owner EPOCH input type	[No Change in Owner EPOCHs]
SGX Launch Control Policy	[Unlocked]
CPU Flex Ratio Override	[Disabled]
CPU Flex Ratio Settings	34
Hardware Prefetcher	[Enabled]
Adjacent Cache Line Prefetch	[Enabled]
Intel (VMX) Virtualization Technology	[Enabled]

C6DRAM [Enabled]

Allows you to enable or disable moving of DRAM contents to PRM memory when the CPU is in C6 state.

Configuration options: [Disabled] [Enabled]

Software Guard Extensions (SGX) [Software Controlled]

Allows you to select the behavior of Software Guard Extensions (SGX).

Configuration options: [Software Controlled] [Disabled] [Enabled]



- Intel SGX is limited for certain CPUs, such as E-2186G, E-2174G, and E-2176G. Please refer to <https://ark.intel.com/> for more information.
- The following items appear only when **Software Guard Extensions (SGX)** is set to **[Enabled]** or **[Software Controlled]**.

Select Owner EPOCH input type [No change in Owner EPOCHs]

Allows you to select the behavior of EPOCH input type.

Configuration options: [No change in Owner EPOCHs] [Change to New Random EPOCHs] [Manual User Defined Owner EPOCHs]

SGX Launch Control Policy [Unlocked]

Allows you to select the behavior of SGX Launch Control Policy.

Configuration options: [Intel Locked] [Unlocked] [Locked]



The following items appear only when you set **SGX Launch Control Policy** to **[Locked]**.

SGX LE Public Key Hash 0-3 [0]



Allows you to set the Bytes of the Software Guard Extensions (SGX) Launch Enclave Public Key Hash. The following item appears only when **Software Guard Extensions (SGX)** is set to **[Enabled]**.

PRMRR Size [256MB]

Allows you to set the PRMRR Size.

Configuration options: [32MB] [64MB] [128MB] [256MB]

CPU Flex Ratio Override [Disabled]

Allows you to enable or disable CPU Flex Ratio Override.

Configuration options: [Disabled] [Enabled]



The following item appears only when **CPU Flex Ratio Override** is set to **[Enabled]**.

CPU Flex Ratio Settings [34]

Allows you to set the CPU Flex Ratio.

This value must be between the Max Efficiency Ratio (LFM) and the Maximum non-turbo ratio set by the Hardware (HFW).

Hardware Prefetcher [Enabled]

This Item allows you to turn on/off the MLC streamer prefetcher.

Configuration options: [Disabled] [Enabled]

Adjacent Cache Line Prefetch [Enabled]

This Item allows you to turn on/off prefetching of adjacent cache lines.

Configuration options: [Disabled] [Enabled]

Intel (VMX) Virtualization Technology [Enabled]

Enable this item to allow a VMM to utilize the additional hardware capabilities provided by Vanderpool Technology.

Configuration options: [Disabled] [Enabled]

Active Processor Cores [All]

This item allows you to set the number of cores to enable in each processor package.

Configuration options: [All] [1] [2] [3]

Hyper-Threading [Enabled]

Enable this option of Windows XP and Linux (OS optimized for Hyper-Threading Technology).

Disable this item for other OS (OS not optimized for Hyper-Threading Technology).

Configuration options: [Disabled] [Enabled]

BIST [Disabled]

Allows you to enable or disable BIST (Built-In Self Test) on reset.

Configuration options: [Disabled] [Enabled]

AES [Enabled]

Allows you to enable or disable AES (Advanced Encryption Standard).

Configuration options: [Disabled] [Enabled]

Intel Trusted Execution Technology [Disabled]

Allows you to enable or disable utilization of additional hardware capabilities provided by Intel(R) Trusted Execution Technology. Changes require a full power cycle to take effect.

Configuration options: [Disabled] [Enabled]

4.5.2 Power & Performance

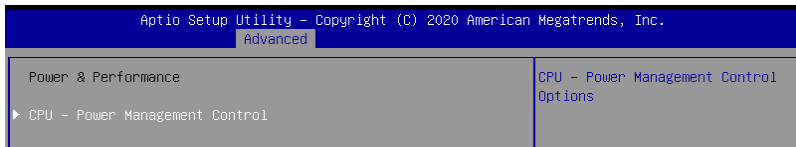

CPU - Power Management Control

Boot performance mode [Max Non-Turbo Performance]

This item allows you to select the performance state that the BIOS will set starting from reset vector.

Configuration options: [Max Battery] [Max Non-Turbo Performance] [Turbo Performance]

Intel(R) SpeedStep(tm) [Enabled]

Allows more than two frequency ranges to be supported.

Configuration options: [Disabled] [Enabled]

Race To Halt (RTH) [Enabled]

Allows you to enable or disable Race To Halt feature. RTH will dynamically increase CPU frequency in order to enter pkg C-State faster to reduce overall power. RTH is controlled through MSR 1FC bit 20.

Configuration options: [Disabled] [Enabled]

Intel(R) Speed Shift Technology [Disabled]

Allows you to enable or disable Intel(R) Speed Shift Technology support. Enabling will expose the CPPC v2 interface to allow for hardware controlled P-states.

Configuration options: [Disabled] [Enabled]

HDC Control [Enabled]

[Disabled] Disable HDC.

[Enabled] Can be enable by OS if OS native support available.

Turbo Mode [Enabled]

Allows you to enable or disable processor turbo mode if Intel Speed Step or Intel Speed Shift is also enabled.

Configuration options: [Disabled] [Enabled]

C-States [Enabled]

Allows you to enable or disable CPU power management, this allows the CPU to enter C-state when not it is not 100 % utilized.

Configuration options: [Disabled] [Enabled]

Enhanced Halt State(C1E) [Enabled]

Allows you to enable or disable C1E. Enable this item to allow the CPU to switch to minimum speed when all cores enter C-State.

Configuration options: [Disabled] [Enabled]

C-State Auto Demotion [C1 and C3]

This item allows you to configure the C-state auto demotion.

Configuration options: [Disabled] [C1] [C3] [C1 and C3]

C-State Un-demotion [C1 and C3]

This item allows you to configure the C-state Un-demotion.

Configuration options: [Disabled] [C1] [C3] [C1 and C3]

Package C-State Demotion [Disabled]

This item allows you to configure the Package C-State Demotion.

Configuration options: [Disabled] [Enabled]

Package C-State Un-demotion [Disabled]

This item allows you to configure the Package C-state Un-demotion.

Configuration options: [Disabled] [Enabled]

Package C-state Limit [Auto]

This item allows you to select the maximum package C-state limit setting.

Configuration options: [C0/C1] [C2] [C3] [C6] [C7] [C8] [C9] [Auto]

C8 Latency Control (MSR 0x633)

Time Unit [1024 ns]

Unit of measurement for IRTL value - bits [12:10].

Latency [250]

Interrupt Response Time Limit value - bits [9:0], Enter 0-1023.

C9 Latency Control (MSR 0x634)

Time Unit [1024 ns]

Unit of measurement for IRTL value - bits [12:10].

Latency [332]

Interrupt Response Time Limit value - bits [9:0], Enter 0-1023.

C10 Latency Control (MSR 0x635)

Time Unit [1024 ns]

Unit of measurement for IRTL value - bits [12:10].

Latency [1010]

Interrupt Response Time Limit value - bits [9:0], Enter 0-1023.

Thermal Monitor [Enabled]

Allows you to enable or disable Thermal Monitoring.

Configuration options: [Disabled] [Enabled]

4.5.3 Server ME Configuration

Aptio Setup Utility - Copyright (C) 2020 American Megatrends, Inc.	
Advanced	
Server ME Configuration	
Operational Firmware Version	10:5.1.4.113
Backup Firmware Version	N/A
Recovery Firmware Version	10:5.1.4.113
ME Firmware Features	SiEn
	PECIProxy
	ICC
	MeStorageServices
	BootGuard
	PTT
	PmBusProxy
	HSIO
	PCHDebug
	PCHThermalSensorInit
	DeepSx
	DirectMeUpdate
	MctpInfrastructure
	TelemetryHub
ME Firmware Status #1	0x00000255
ME Firmware Status #2	0x8011C027
Current State	Operational
Error Code	No Error
	++: Select Screen F1: Select Item Enter: Select +/-: Change Opt. F1: General Help F2: Previous Values F5: Optimized Defaults F10: Save & Reset F12: Print Screen ESC: Exit

4.5.4 Trusted Computing

Aptio Setup Utility - Copyright (C) 2020 American Megatrends, Inc.	
Advanced	
Configuration	
Security Device Support	[Disable]
Disable Block Sid	[Disabled]
NO Security Device Found	
	Enables or Disables BIOS support for security device. O.S. will not show Security Device. TCG EFI protocol and INT1A interface will not be

Security Device Support [Disabled]

This item allows you to enable or disable Security Device Support.

Configuration options: [Disabled] [Enabled]



The following item appears only when **Security Device Support** is set to **[Enabled]**.

TPM Device Selection [PTT]

Allows you to select the TPM device.

Configuration options: [PTT] [dTPM]

Disable Block Sid [Disabled]

This item allows you to override to allow SID authentication in TCG Storage device.

Configuration options: [Enabled] [Disabled]

4.5.5 APM Configuration

Aptio Setup Utility - Copyright (C) 2020 American Megatrends, Inc.		
Advanced		
Restore AC Power Loss	[Last State]	Restore On AC Power Loss
Power On By PCI-E/PCI	[Disabled]	
Power On By RTC	[Disabled]	

Restore AC Power Loss [Last State]

When set to [Power Off], the system goes into off state after an AC power loss. When set to [Power On], the system will reboot after an AC power loss. When set to [Last State], the system goes into either off or on state, whatever the system state was before the AC power loss.

Configuration options: [Power Off] [Power On] [Last State]

Power On By PCI-E/PCI [Disabled]

[Disabled] Disables the PCI or PCIE devices to generate a wake event.

[Enabled] Enables the PCI or PCIE devices to generate a wake event.

Power On By RTC [Disabled]

[Disabled] Disables RTC to generate a wake event.

[Enabled] When set to [Enabled], the items **RTC Alarm Date (Days)** and **Hour/Minute/Second** will become user-configurable with set values.

4.5.6 Runtime Error Logging Settings

Aptio Setup Utility - Copyright (C) 2020 American Megatrends, Inc.		
Advanced		
Runtime Error Logging Settings		Runtime Error Logging System Enable/Disable
Runtime Error Logging System Enabling	[Enabled]	

Runtime Error Logging System Enabling [Enabled]

This item allows you to enable or disable Runtime Error Logging System.

Configuration options: [Disabled] [Enabled]

4.5.7 Onboard LAN Configuration

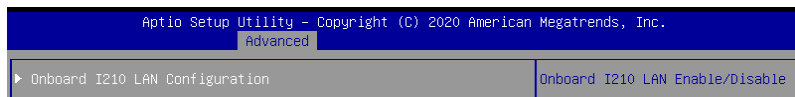

Onboard I210 LAN Configuration

Intel I210 LAN1

LAN Enable [JumperState]

Allows you to enable or disable the Intel LAN.
Configuration options: [Disabled] [JumperState]



The following item appears only when **LAN Enable** is set to **[JumperState]**.

ROM Type [PXE]

Allows you to select the Intel LAN ROM type.
Configuration options: [Disabled] [PXE] [iSCSI]



Due to Intel® limitations, both Intel LAN ROM Type options should be the same when **[PXE]** or **[iSCSI]** is selected.

Intel I210 LAN2

LAN Enable [JumperState]

Allows you to enable or disable the Intel LAN.
Configuration options: [Disabled] [JumperState]



The following item appears only when **LAN Enable** is set to **[JumperState]**.

ROM Type [Disabled]

Allows you to select the Intel LAN ROM type.
Configuration options: [Disabled] [PXE] [iSCSI]



Due to Intel® limitations, both Intel LAN ROM Type options should be the same when **[PXE]** or **[iSCSI]** is selected.

4.5.8 Serial Port Console Redirection

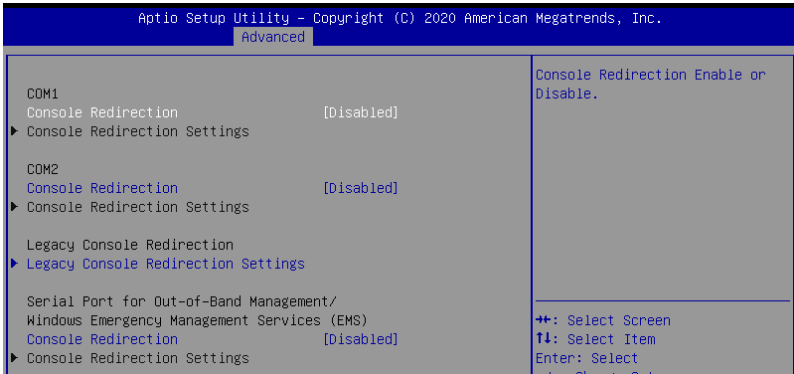

COM1/COM2

Console Redirection [Disabled]

Allows you to enable or disable the console redirection feature.

Configuration options: [Disabled] [Enabled]



The following item appears only when **Console Redirection** is set to [Enabled].

Console Redirection Settings

These items become configurable only when you enable the **Console Redirection** item. The settings specify how the host computer and the remote computer (which the user is using) will exchange data. Both computers should have the same or compatible settings.

Terminal Type [VT-UTF8]

Allows you to set the terminal type.

[VT100] ASCII char set.

[VT100+] Extends VT100 to support color, function keys, etc.

[VT-UTF8] Uses UTF8 encoding to map Unicode chars onto 1 or more bytes.

[ANSI] Extended ASCII char set.

Bits per second [57600]

Selects serial port transmission speed. The speed must be matched on the other side. Long or noisy lines may require lower speeds.

Configuration options: [9600] [19200] [38400] [57600] [115200]

Data Bits [8]

Configuration options: [7] [8]

Parity [None]

A parity bit can be sent with the data bits to detect some transmission errors. [Mark] and [Space] parity do not allow for error detection.

[None]	None
[Even]	parity bit is 0 if the num of 1's in the data bits is even
[Odd]	parity bit is 0 if num of 1's in the data bits is odd
[Mark]	parity bit is always 1
[Space]	parity bit is always 0

Stop Bits [1]

Stop bits indicate the end of a serial data packet. (A start bit indicates the beginning.) The standard setting is 1 stop bit. Communication with slow devices may require more than 1 stop bit.

Configuration options: [1] [2]

Flow Control [Hardware RTS/CTS]

Flow control can prevent data loss from buffer overflow. When sending data, if the receiving buffers are full, a "stop" signal can be sent to stop the data flow. Once the buffers are empty, a "start" signal can be sent to re-start the flow. Hardware flow control uses two wires to send start/stop signals.

Configuration options: [None] [Hardware RTS/CTS]

VT -UTF8 Combo Key Support [Enabled]

This allows you to enable the VT -UTF8 Combination Key Support for ANSI/VT100 terminals.

Configuration options: [Disabled] [Enabled]

Recorder Mode [Disabled]

With this mode enabled only text will be sent. This is to capture Terminal data.

Configuration options: [Disabled] [Enabled]

Resolution 100x31 [Enabled]

This allows you to enable or disable extended terminal resolution.

Configuration options: [Disabled] [Enabled]

Putty Keypad [VT100]

This allows you to select the FunctionKey and Keypad on Putty.

Configuration options: [VT100] [LINUX] [XTERMR6] [SCO] [ESCN] [VT400]

Legacy Console Redirection Settings

Legacy Console Redirection Port [COM1]

Allows you to select a COM port to display redirection of Legacy OS and Legacy OPROM Messages.

Configuration options: [COM1] [COM2]

Resolution [80x24]

Allows you to select a the number of rows and columns in supported redirection.

Configuration options: [80x24] [80x25]

Redirect After POST [Always Enable]

Allows you to select the redirection after POST.

Configuration options: [Always Enable] [BootLoader]

Serial Port for Out-of-Band Management/Windows Emergency Management Services (EMS)

Console Redirection [Disabled]

Allows you to enable or disable the console redirection feature.

Configuration options: [Disabled] [Enabled]



The following item appears only when you set **Console Redirection** to **[Enabled]**.

Console Redirection Settings

Out-of-Band Mgmt Port [COM1]

Microsoft Windows Emergency Management Services (EMS) allow for remote management of a Windows Server OS through a serial port.

Configuration options: [COM1] [COM2]

Terminal Type [VT-UTF8]

Microsoft Windows Emergency Management Services (EMS) allow for remote management of a Windows Server OS through a serial port.

Configuration options: [VT100] [VT100+] [VT-UTF8] [ANSI]

Bits per second [115200]

Microsoft Windows Emergency Management Services (EMS) allow for remote management of a Windows Server OS through a serial port.

Configuration options: [9600] [19200] [57600] [115200]

Flow Control [None]

Microsoft Windows Emergency Management Services (EMS) allow for remote management of a Windows Server OS through a serial port.

Configuration options: [None] [Hardware RTS/CTS] [Software Xon/Xoff]

4.5.9 Intel TXT Information

You may view the Intel TXT information in this menu.

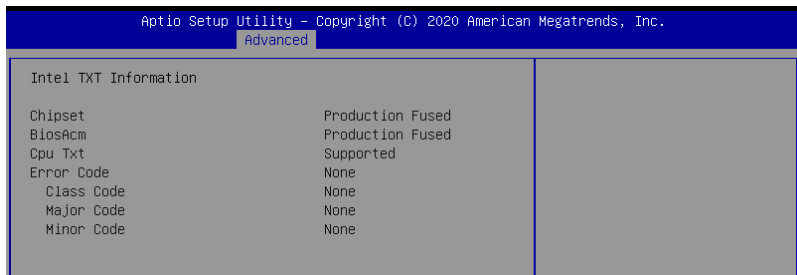

4.5.10 SIO Configuration

Allows you to configure SIO configurations.

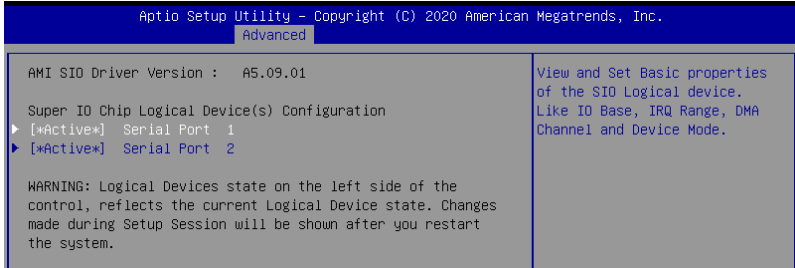

Super IO Chip Logical Device(s) Configuration

[*Active*] Serial Port 1

The items in this sub menu allow you to view and set basic properties of the SIO Logical device, such as IO Base, IRQ range, DMA channel, and device mode.

Use This Device [Enabled]

This item allows you to enable or disable this logical device.

Configuration options: [Enabled] [Disabled]



Disabling SIO Logical Devices may have unwanted side effects. PROCEED WITH CAUTION.



The following item appears only when **Use This Device** is set to **[Enabled]**.

Possible: [Use Automatic Settings]

Allows the user to change the device resource settings. New settings will be reflected on this setup page after the system restarts.

Configuration options: [Use Automatic Settings] [IO=3F8h; DMA;] [IO=3F8h; IRQ=3, 4, 5, 7, 9, 10, 11, 12; DMA;] [IO=2F8h; IRQ=3, 4, 5, 7, 9, 10, 11, 12; DMA;] [IO=3E8h; IRQ=3, 4, 5, 7, 9, 10, 11, 12; DMA;] [IO=2E8h; IRQ=3, 4, 5, 7, 9, 10, 11, 12; DMA;]

[*Active*] Serial Port 2

The items in this sub menu allow you to view and set basic properties of the SIO Logical device, such as IO Base, IRQ range, DMA channel, and device mode.

Use This Device [Enabled]

This item allows you to enable or disable this logical device.

Configuration options: [Enabled] [Disabled]



Disabling SIO Logical Devices may have unwanted side effects. PROCEED WITH CAUTION.



The following item appears only when **Use This Device** is set to **[Enabled]**.

Possible: [Use Automatic Settings]

Allows the user to change the device resource settings. New settings will be reflected on this setup page after the system restarts.

Configuration options: [Use Automatic Settings] [IO=3F8h; DMA;] [IO=3F8h; IRQ=3, 4, 5, 7, 9, 10, 11, 12; DMA;] [IO=2F8h; IRQ=3, 4, 5, 7, 9, 10, 11, 12; DMA;] [IO=3E8h; IRQ=3, 4, 5, 7, 9, 10, 11, 12; DMA;] [IO=2E8h; IRQ=3, 4, 5, 7, 9, 10, 11, 12; DMA;]

Mode: [Disable IR1 function]

Allows you to change the Serial Port mode.

Configuration options: Disable IR1 function] [IrDA Active pulse 1.6 uS] [IrDA Active pulse 3/16 bit time] [ASKIR Mode]

4.5.11 PCI Subsystem Settings

Allows you to configure PCI, PCI-X, and PCI Express Settings.

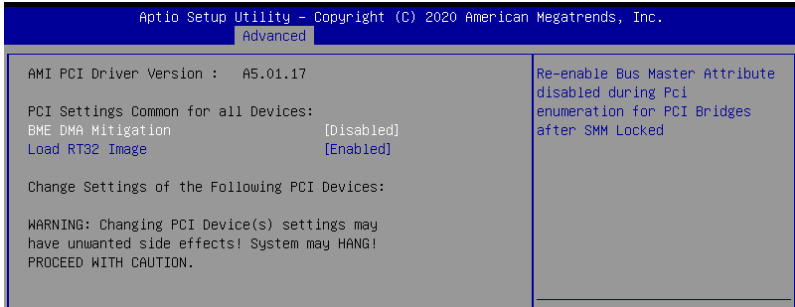

BME DMA Mitigation [Disabled]

This allows you to enable or disable re-enabling Bus Master Attribute disabled during Pci enumeration for PCI Bridges after SMM locked.

Configuration options: [Disabled] [Enabled]

Load RT32 Image [Enabled]

This allows you to enable or disable RT32 Image Loading.

Configuration options: [Disabled] [Enabled]

4.5.12 USB Configuration

Aptio Setup Utility - Copyright (C) 2020 American Megatrends, Inc.	
Advanced	
USB Configuration	Enables Legacy USB support. AUTO option disables legacy support if no USB devices are connected. DISABLE option will keep USB devices available only for EFI applications.
USB Module Version	23
USB Controllers:	
1 XHCI	
USB Devices:	
1 Drive, 1 Keyboard, 1 Mouse	
Legacy USB Support	[Enabled]
XHCI Hand-off	[Enabled]
USB Mass Storage Driver Support	[Enabled]
Port 60/64 Emulation	[Enabled]
USB hardware delays and time-outs:	
USB transfer time-out	[20 sec]
Device reset time-out	[20 sec]
Device power-up delay	[Auto]
Mass Storage Devices:	
JetFlashTranscend 4GB 8.07	[Auto]

++: Select Screen
T1: Select Item
Enter: Select
+/-: Change Opt.
F1: General Help
F2: Previous Values
F5: Optimized Defaults
F10: Save & Reset
F12: Print Screen

Legacy USB Support [Enabled]

[Disabled] The USB devices can be used only for the BIOS setup program. It cannot be recognized in boot devices list.

[Enabled] Enables the support for USB devices on legacy operating systems (OS).

[Auto] Allows the system to detect the presence of USB devices at startup. If detected, the USB controller legacy mode is enabled. If no USB device is detected, the legacy USB support is disabled.

XHCI Hand-off [Enabled]

Allows you to enable or disable workaround for OS(s) without XHCI hand-off support.
Configuration options: [Disabled] [Enabled]

USB Mass Storage Driver Support [Enabled]

Allows you to enable or disable USB Mass Storage driver support.
Configuration options: [Disabled] [Enabled]

Port 60/64 Emulation [Enabled]

Allows you to enable or disable Port 60/64 Emulation.
Configuration options: [Disabled] [Enabled]

USB hardware delays and time-outs

USB transfer time-out [20 sec]

Allows you to set the USB transfer time-out value.
Configuration options: [1 sec] [5 sec] [10 sec] [20 sec]

Device reset time-out [20 sec]

Allows you to set the device reset time-out value.
Configuration options: [10 sec] [20 sec] [30 sec] [40 sec]

Device power-up delay [Auto]

Allows you to set the maximum time the device takes before the device reports itself to the host controller properly.

Configuration options: [Auto] [Manual]



The following item appears only when you set **Device power-up delay** to **[Manual]**.

Device power-up delay in seconds [5]

Allows you to set the device power-up delay in seconds. Use the <+> or <-> to adjust the value. The values range from 1 to 40.

Mass Storage Devices

Allows you to select the mass storage device emulation type for devices connected.

Configuration options: [Auto] [Floppy] [Forced FDD] [Hard Disk] [CD-ROM]

4.5.13 CSM Configuration

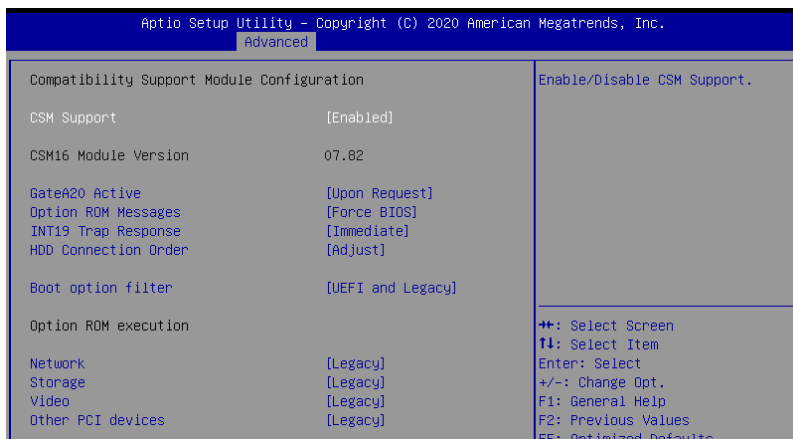

CSM Support [Enabled]

This option allows you to enable or disable CSM Support.

Configuration options: [Disabled] [Enabled]



The following items appear only when **CSM Support** is set to **[Enabled]**.

GateA20 Active [Upon Request]

This allows you to set the GA20 option.

[Upon Request]

GA20 can be disabled using BIOS services.

[Always]

Do not allow disabling GA20; this option is useful when any RT code is executed above 1MB.

Option ROM Messages [Force BIOS]

This allows you to set the display mode for option ROM.

Configuration options: [Force BIOS] [Keep Current]

INT19 Trap Response [Immediate]

This option allows you to control the BIOS reaction on INT19 trapping by Option ROM.

Configuration options: [Immediate] [Postponed] [Auto]

HDD Connection Order [Adjust]

This option allows you to select the HDD Connection Order. Some OS require HDD handles to be adjusted.

Configuration options: [Adjust] [Keep]

Boot Option filter [UEFI and Legacy]

This option allows you to control the Legacy/UEFI ROMs priority.

Configuration options: [UEFI and Legacy] [Legacy only] [UEFI only]

Network / Storage / Video [Legacy]

This option allows you to control the execution of UEFI and Legacy PXE/ Storage/ Video OpROM.

Configuration options: [Do not launch] [UEFI] [Legacy]

Other PCI devices [Legacy]

This item determines the OpROM execution policy for devices other than Network, Storage, or Video.

Configuration options: [Do not launch] [UEFI] [Legacy]

4.5.14 NVMe Configuration

You may view the NVMe controller and Drive information if an NVMe device is connected.

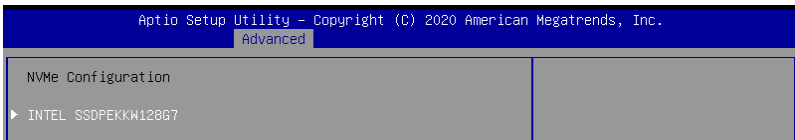

4.5.15 WHEA Configuration

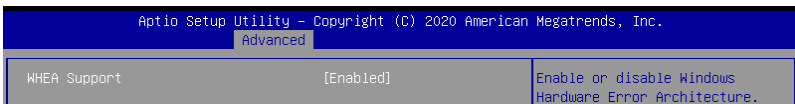

Whea Support [Enabled]

This item allows you to enable or disable the WHEA support.

Configuration options: [Disabled] [Enabled]

4.5.16 Tls Auth Configuration

Allows you to configure the Tls Auth.

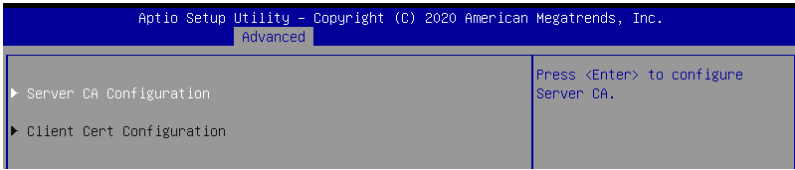

4.5.17 Network Stack Configuration

Allows you to configure the network stack configuration.

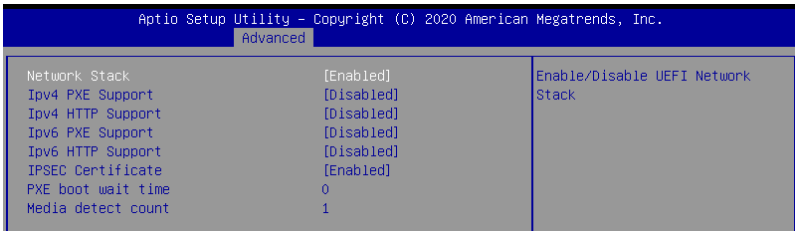

Network Stack [Enabled]

Allows you to enable or disable UEFI Network Stack.

Configuration options: [Disabled] [Enabled]



The following items appear only when **Network Stack** is set to **[Enabled]**.

Ipv4 PXE Support [Disabled]

Enables or disables the Ipv4 PXE Boot Support. If disabled, Ipv4 PXE boot option will not be created.

Configuration options: [Disabled] [Enabled]

Ipv4 HTTP Support [Disabled]

Enables or disables the Ipv4 HTTP Boot Support. If disabled, Ipv4 PXE boot option will not be created.

Configuration options: [Disabled] [Enabled]

Ipv6 PXE Support [Disabled]

Enables or disables the Ipv6 PXE Boot Support. If disabled, Ipv6 PXE boot option will not be created.

Configuration options: [Disabled] [Enabled]

Ipv6 HTTP Support [Disabled]

Enables or disables the Ipv6 HTTP Boot Support. If disabled, Ipv6 PXE boot option will not be created.

Configuration options: [Disabled] [Enabled]

IPSEC Certificate [Enabled]

Enables or disables support for IPSEC Certificate.

Configuration options: [Disabled] [Enabled]

PXE boot wait time [0]

Set the wait time to press ESC key to abort the PXE boot. Use the <+> or <-> to adjust the value. The values range from 0 to 5.

Media detect count [1]

Set the number of times presence of media will be checked. Use the <+> or <-> to adjust the value. The values range from 1 to 50.

4.5.18 RAM Disk Configuration

Allows you to configure the RAM Disk configurations.

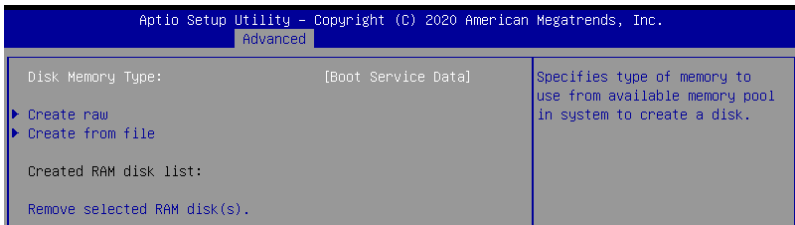

Disk Memory Type: [Boot Service Data]

This item allows you to specify the type of memory to use from the available memory pool in the system to create a disk.

Configuration options: [Boot Service Data] [Reserved]

Create raw

This item allows you to create a raw RAM disk.

Size (Hex):

This item allows you to enter valid RAM disk size and should be in multiples of the RAM disk block size.

Create & Exit

This option allows you to create a new RAM disk with the given starting and ending address.

Discard & Exit

This option allows you to discard changes made and exit.

Create from file

This item allows you to create a RAM disk from a given file.

Remove selected RAM disk(s).

This item allows you to remove the selected RAM disk(s).

4.5.19 iSCSI Configuration

Allows you to configure the iSCSi parameters.

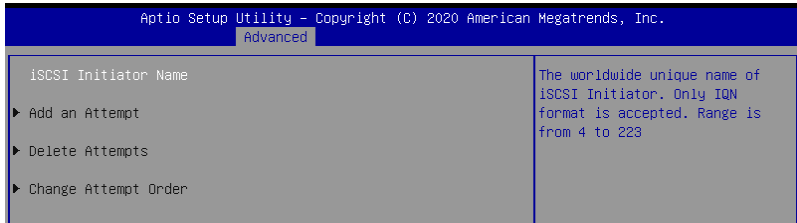

4.6 Chipset menu

The Chipset menu allows you to change the platform settings.

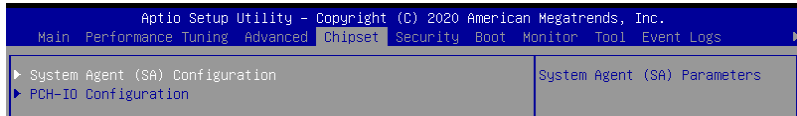

Take caution when changing the settings of the Chipset menu items. Incorrect field values can cause the system to malfunction.

4.6.1 System Agent (SA) Configuration

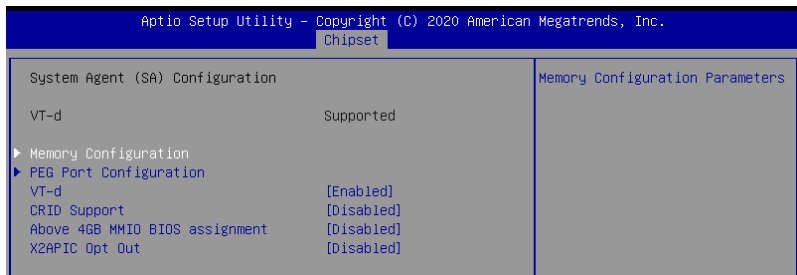

Memory Configuration

Memory Test on Warm Boot [Enabled]

Allows you to enable or disable the Base Memory Test Run on Warm Boot.
Configuration options: [Disabled] [Enabled]

Memory Frequency [Auto]

Allows you to select the maximum memory frequency setting.
Configuration options: [Auto] [2133] [2400] [2666]

ECC Support [Enabled]

Allows you to enable or disable the ECC support.
Configuration options: [Disabled] [Enabled]

Memory Scrambler [Enabled]

Allows you to enable or disable Memory Scrambler.
Configuration options: [Disabled] [Enabled]

Fast Boot [Disabled]

Allows you to enable or disable Fast Boot.
Configuration options: [Disabled] [Enabled]

PEG Port Configuration**PEG 0:1:0****Max Link Speed [Auto]**

Allows you to set the Max Link Speed.
Configuration options: [Auto] [Gen1] [Gen2] [Gen3]

Max Link Width [Auto]

Allows you to force PEG link to retrain to X1/2/4/8.
Configuration options: [Auto] [Force X1] [Force X2] [Force X4] [Force X8]

Power Down Unused Lanes [Auto]

[Disabled]	No power saving.
[Auto]	BIOS will power down unused lanes based on the max possible link width.

Gen3 Eq Phase 2 [Auto]

This item allows you to perform Gen3 Equalization Phase 2.
Configuration options: [Disabled] [Enabled] [Auto]

Gen3 Eq Phase 3 Method [Auto]

This item allows you to select a method for Gen3 Equalization Phase 3.
Configuration options: [Auto] [Adaptive Hardware Equalization] [Adaptive Software Equalization] [Static Equalization] [Disabled]

ASPM

This item allows you to control ASPM support for the PEG 0. This has no effect if PEG is not the currently active device.
Configuration options: [Disabled] [Auto] [ASPM L0s] [ASPM L1] [ASPM L0sL1]

De-emphasis Control [-3.5 dB]

PEG0: Configure the De-emphasis control on PEG.
Configure options: [-6 dB] [-3.5dB]

0BFF [Enabled]

CPU PEG0 (0,1,0) 0BFF enable or disable.
Configuration options: [Disabled] [Enabled]

LTR [Enabled]

CPU PEG0 (0,1,0) Latency Reporting enable or disable.
Configuration options: [Disabled] [Enabled]

PEG0 Slot Power Limit Value [75]

Set the upper limit on power supplied by slot. Use the <+> or <-> to adjust the value. The values range from 0 to 255.

PEG0 Slot Power Limit Scale [1.0x]

Allows you to select the scale for the Slot Power Limit Value.
Configuration options: [1.0x] [0.1x] [0.01x] [0.001x]

PEG0 Physical Slot Number [1]

Allows you to set the physical slot number attached to this Port. The number has to be globally unique within the chassis. Use the <+> or <-> to adjust the value. The values range from 0 to 8191.

PEG 0:1:1**Max Link Speed [Auto]**

Allows you to set the Max Link Speed.
Configuration options: [Auto] [Gen1] [Gen2] [Gen3]

PEG1 Slot Power Limit Value [75]

Set the upper limit on power supplied by slot. Use the <+> or <-> to adjust the value. The values range from 0 to 255.

PEG1 Slot Power Limit Scale [1.0x]

Allows you to select the scale for the Slot Power Limit Value.
Configuration options: [1.0x] [0.1x] [0.01x] [0.001x]

PEG1 Physical Slot Number [2]

Allows you to set the physical slot number attached to this Port. The number has to be globally unique within the chassis. Use the <+> or <-> to adjust the value. The values range from 0 to 8191.

PEG 0:1:2**Max Link Speed [Auto]**

Allows you to set the Max Link Speed.
Configuration options: [Auto] [Gen1] [Gen2] [Gen3]

PEG2 Slot Power Limit Value [75]

Set the upper limit on power supplied by slot. Use the <+> or <-> to adjust the value. The values range from 0 to 255.

PEG2 Slot Power Limit Scale [1.0x]

Allows you to select the scale for the Slot Power Limit Value.
Configuration options: [1.0x] [0.1x] [0.01x] [0.001x]

PEG2 Physical Slot Number [3]

Allows you to set the physical slot number attached to this Port. The number has to be globally unique within the chassis. Use the <+> or <-> to adjust the value. The values range from 0 to 8191.

PEG3 Slot Power Limit Value [75]

Set the upper limit on power supplied by slot. Use the <+> or <-> to adjust the value. The values range from 0 to 255.

PEG3 Slot Power Limit Scale [1.0x]

Allows you to select the scale for the Slot Power Limit Value.

Configuration options: [1.0x] [0.1x] [0.01x] [0.001x]

PEG3 Physical Slot Number [3]

Allows you to set the physical slot number attached to this Port. The number has to be globally unique within the chassis. Use the <+> or <-> to adjust the value. The values range from 0 to 8191.

PEG0 Max Payload size [Auto]

This item allows you to select the PEG0 Max Payload Size; Choose Auto (default device capability) or force to 128/256 Bytes.

Configuration options: [Auto] [128] [256 TLP]

VT-d [Enabled]

Allows you to enable or disable VT-d capability.

Configuration options: [Disabled] [Enabled]

CRID Support [Disabled]

Allows you to enable or disable CRID control for Intel SIPP.

Configuration options: [Disabled] [Enabled]

Above 4GB MMIO BIOS Assignment [Disabled]

Allows you to enable or disable above 4 GB memory mapped IO BIOS assignment. This is enabled automatically if the aperture size is set to 2048MB.

Configuration options: [Disabled] [Enabled]



The following item is configurable only when **VT-d** is set to **[Enabled]**.

X2APIC Opt Out [Disabled]

Allows you to enable or disable X2APIC Opt Out.

Configuration options: [Disabled] [Enabled]

4.6.2 PCH-IO Configuration



PCI Express Configuration

PCI Express Clock Gating [Enabled]

Allows you to enable or disable PCI Express clock gating for each root port.

Configuration options: [Disabled] [Enabled]

DMI Link ASPM Control [Auto]

Allows you to enable or disable control of active state power management of DMI link.
Configuration options: [Disabled] [L0s] [L1] [L0sL1] [Auto]

Port8xh Decode [Disabled]

Allows you to enable or PCI express port 8xh decode.
Configuration options: [Disabled] [Enabled]



The following item appears only when **Port8xh Decode** is set to **[Enabled]**.

Port8xh Decode Port# [0]

Select PCI Express Port8xh Decode Root Port. User to ensure port availability.
Configuration options: [0] - [23]

SATA And RSTe Configuration

SATA Controller(s) [Enabled]

Allows you to enable or disable the SATA Controller.
Configuration options: [Disabled] [Enabled]



The following items appear only when **SATA Controller(s)** is set to **[Enabled]**.

SATA Mode Selection [AHCI]

Allows you to select the SATA controllers operation.
Configuration options: [AHCI] [RAID]

SATA1-6

Port 1-6 [Enabled]

Allows you to enable or disable the SATA port.
Configuration options: [Disabled] [Enabled]

Hot Plug [Enabled]

Allows you to enable or disable this port as hot pluggable.
Configuration options: [Disabled] [Enabled]

Spin Up Device [Disabled]

Allows you to enable or disable Spin Up Device.
Configuration options: [Disabled] [Enabled]

SATA Device Type [Hard Disk Drive]

Allows you to identify the SATA port is connected to a solid state drive or a hard disk drive
Configuration options: [Hard Disk Drive] [Solid State Drive]

Teton Glacier Mode [Disabled]

This item allows you to select the Teton Glacier Mode.

Configuration options: [Static Configuration for Teton Glacier Enable] [Dynamic Configuration for Teton Glacier Enable] [Disabled]



The following item appears only when **Teton Glacier Mode** is set to **[Static Configuration for Teton Glacier Enable]**.

Teton Glacier connected to Cycle Router [Cycle Router 0]

Select the Cycle Router to which Teton Glacier is connected.

Configuration options: [Cycle Router 0] [Cycle Router 1] [Cycle Router 2]

4.7 Security menu

This menu allows a new password to be created or a current password to be changed. The menu also enables or disables the Secure Boot state and lets the user configure the System Mode state.

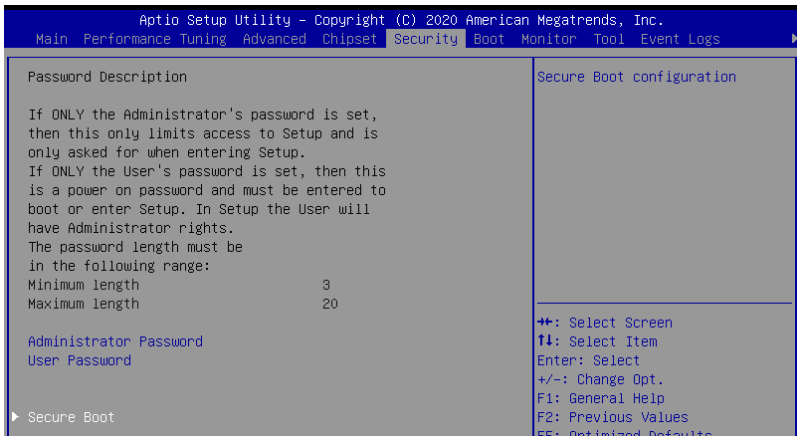

Administrator Password

To set an administrator password:

1. Select the Administrator Password item and press <Enter>.
2. From the Create New Password box, key in a password, then press <Enter>.
3. Confirm the password when prompted.

To change an administrator password:

1. Select the Administrator Password item and press <Enter>.
2. From the Enter Current Password box, key in the current password, then press <Enter>.
3. From the Create New Password box, key in a new password, then press <Enter>.
4. Confirm the password when prompted.



To clear the administrator password, follow the same steps as in changing an administrator password, but press <Enter> when prompted to create/confirm the password.

User Password

To set a user password:

1. Select the User Password item and press <Enter>.
2. From the Create New Password box, key in a password, then press <Enter>.
3. Confirm the password when prompted.

To change a user password:

1. Select the User Password item and press <Enter>.
2. From the Enter Current Password box, key in the current password, then press <Enter>.
3. From the Create New Password box, key in a new password, then press <Enter>.
4. Confirm the password when prompted.

To clear a user password:

1. Select the Clear User Password item and press <Enter>.
2. Select Yes from the Warning message window then press <Enter>.

Secure Boot

This item allows you to customize the Secure Boot settings.

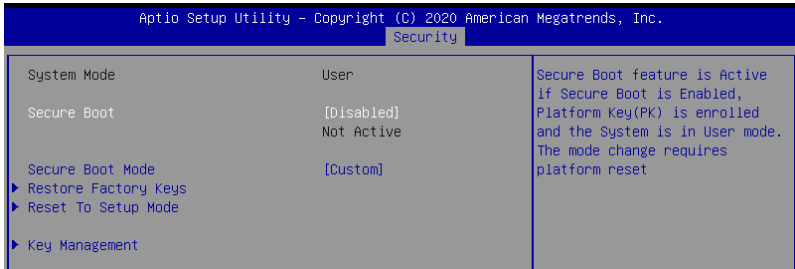

Secure Boot [Disabled]

Secure Boot can be enabled if the system is running in User mode with enrolled platform Key (EPK) or if the CSM function is disabled.

Configuration options: [Disabled] [Enabled]

Secure Boot Mode [Custom]

Allows you to set the Secure Boot selector.

Configuration options: [Custom] [Standard]

Restore Factory Keys

This option will force the system to User Mode, and install factory default Secure Boot key databases.

Reset to Setup Mode

This option will delete all Secure Boot key databases from NVRAM.

Key Management

This item only appears when the item **Secure Boot Mode** is set to **[Custom]**. The Key Management item allows you to modify Secure Boot variables and set Key Management page.

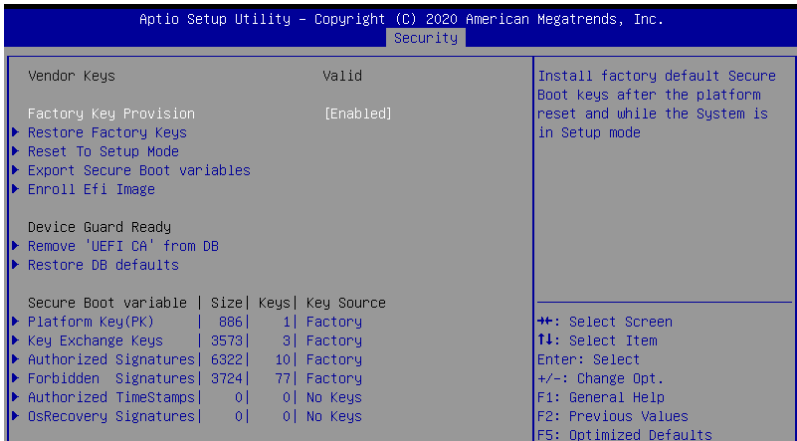

Factory Key Provision [Disabled]

Allows you to provision factory default Secure Boot keys when the system is in Setup Mode.

Configuration options: [Disabled] [Enabled]

Restore Factory keys

This item will install all Factory Default keys.

Reset to Setup Mode

This item appears only when you load the default Secure Boot keys. This item allows you to clear all default Secure Boot keys.

Export Secure Boot Variables

This item will ask you if you want to save all secure boot variables. Select Yes if you want to save all secure boot variables, otherwise select No.

Enroll Efi Image

This item will allow the image to run in Secure Boot mode.

Configuration options: [Set New] [Append]

Device Guard Ready

Remove 'UEFI CA' from DB

Remove Microsoft UEFI CA from Secure Boot DB.

Restore DB defaults

Restore DB variable to factory defaults.

Platform Key (PK)

Configuration options: [Details] [Export] [Update] [Delete]

Key Exchange Keys (KEK) / Authorized Signatures (DB) / Forbidden Signatures (DBX)

Configuration options: [Details] [Export] [Update] [Append] [Delete]

Authorized TimeStamps (DBT) / OsRecovery Signatures

Configuration options: [Update] [Append]

4.8 Boot menu

The Boot menu items allow you to change the system boot options.

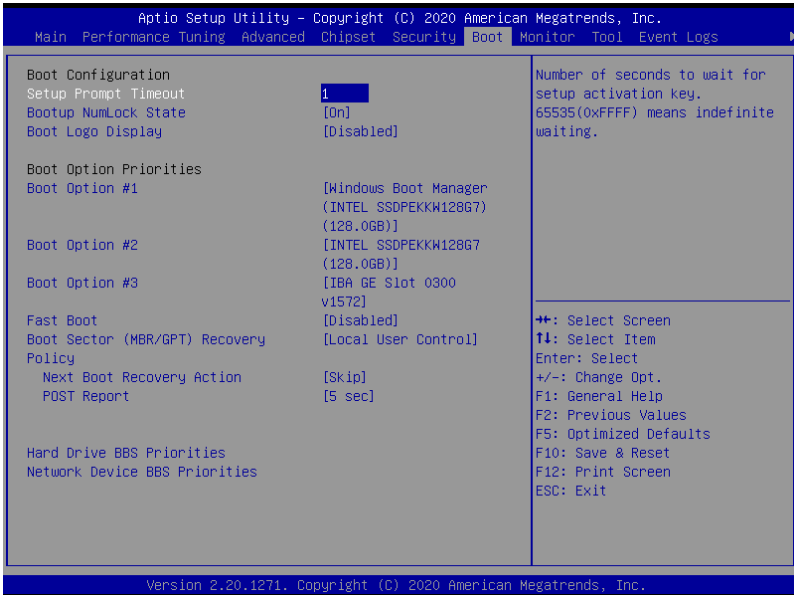

Setup Prompt Timeout [1]

Allows you to set the number of seconds that the firmware waits before initiating the original default boot selection. 65535(0xFFFF) means indefinite waiting. Use the <+> or <-> to adjust the value.

Bootup NumLock State [On]

Allows you to select the power-on state for the NumLock.
Configuration options: [Off] [On]

Boot Logo Display [Disabled]

[Full Screen] Maximize the boot logo size.
[Disabled] Hide the logo during POST.

Boot Option Priorities

These items specify the boot device priority sequence from the available devices. The number of device items that appears on the screen depends on the number of devices installed in the system.



- To select the boot device during system startup, press <F8> when ASUS Logo appears.
- To access Windows OS in Safe Mode, please press <F8> after POST.

Fast Boot [Disabled]

Allows you to enable or disable boot with initialization of a minimal set of devices required to launch active boot option. This has no effect for BBS boot options.
Configuration options: [Disabled] [Enabled]



The following item appears only when **Fast Boot** is set to **[Enabled]**.

Sata Support [Last Boot HDD Only]

[Last Boot HDD Only] Only last booted HDD device will be available in POST.
[All Sata Devices] All SATA devices will be available in OS and POST.

NVMe Support [Enabled]

If this item is disabled, NVMe device will be skipped.
Configuration options: [Disabled] [Enabled]

VGA Support [EFI Driver]

[Auto] Only legacy OpRom with Legacy OS, and logo will NOT be shown during POST.
[EFI Driver] Efi driver will still be installed with EFI OS.

USB Support [Full Initial]

[Disabled] All USB devices will NOT be available until after OS boot.
[Partial Initial] USB Mass Storage and specific USB port/device will NOT be available before OS boot.
[Full Initial] All USB devices will be available in OS and POST.

PS2 Devices Support [Enabled]

If this option is disabled, PS2 devices will be skipped.

Configuration options: [Disabled] [Enabled]

Network Stack Driver Support [Disabled]

If this option is disabled, Network Stack Driver will be skipped.

Configuration options: [Disabled] [Enabled]

Redirection Support [Disabled]

If this option is disabled, Redirection function will be disabled.

Configuration options: [Disabled] [Enabled]



The following item appears only when **Boot Logo Display** is set to **[Disabled]**.

POST Report [5 sec]

Allows you to set the desired POST Report waiting time from 1 to 10 seconds.

Configuration options: [1 sec] - [10 sec] [Until Press ESC]

Boot Sector (MBR/GPT) Recovery Policy [Local User Control]

This item allows you to determine the Boot Sector Policy. Auto Recovery: Follow UEFI Rule.
Local User control : You can enter setup page and select the recovery MBR/GPT on the next boot of time.

Configuration options: [Auto Recovery] [Local User Control]



The following item appears only when **Boot Sector (MBR/GPT) Recovery Policy** is set to **[Local User Control]**.

Next Boot Recovery Action [Skip]

Choose the (MBR/GPT) recovery action on the next boot.

Configuration options: [Skip] [Recovery]

Post Report [5 sec]

Select the desired Post Report waiting time from 1~10 sec.

Configuration options: [1 sec] - [10 sec] [Until Press ESC]

Hard Drive BBS Priorities / Network Device BBS Priorities

These items appear only when you connect a network cable or SATA ODD to the SATA port, and allows you to set the booting order of the Network / SATA devices.

4.9 Monitor menu

This menu displays the system temperature, fan speed, and power status. You can also change the fan settings in this menu.

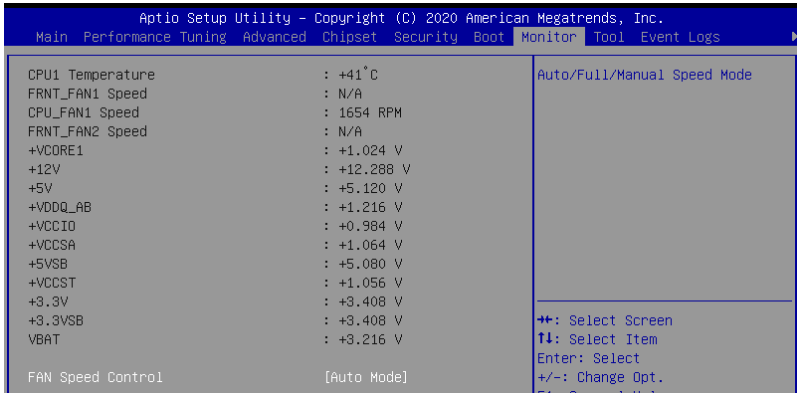

Fan Speed Control [Auto Mode]

Allows you to select the power-on state for the NumLock.

Configuration options: [Auto Mode] [Full Speed Mode] [Manual Speed Mode]



The following items appear only when **Fan Speed Control** is set to **[Manual Speed Mode]**.

REAR_FAN1 / CPU_FAN1 / FRNT_FAN1 Duty% [50]

Allows you to set the desired POST Report waiting time from 1 to 10 seconds. Use the <+> or <-> to adjust the value. The values range from 10 to 100.

4.10 Tool menu

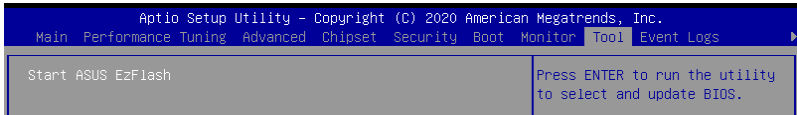

Start ASUS EzFlash

Allows you to run ASUS EZ Flash BIOS ROM Utility when you press <Enter>. Refer to the ASUS EZ Flash Utility section for details.

4.11 Event Logs menu

The Event Logs menu items allow you to change the event log settings and view the system event logs.

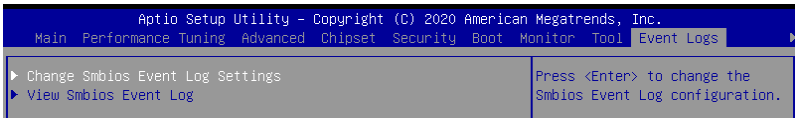

4.11.1 Change Smbios Event Log Settings

Press <Enter> to change the Smbios Event Log configuration.



All values changed here do not take effect until computer is restarted.

Enabling/Disabling Options

Smbios Event Log [Enabled]

Change this to enable or disable all features of Smbios Event Logging during boot.
Configuration options: [Disabled] [Enabled]



The following items appear only when **Smbios Event Log** is set to [Enabled].

Erasing Settings

Erase Event Log [No]

Choose options for erasing Smbios Event Log. Erasing is done prior to any logging activation during reset.

Configuration options: [No] [Yes, Next reset] [Yes, Every reset]

When Log is Full [Do Nothing]

Choose options for reacting to a full Smbios Event Log.
Configuration options: [Do Nothing] [Erase Immediately]

Custom Options

Log EFI Status Code [Enabled]

This option allows you to enable or disable logging of the EFI Status Codes.
Configuration options: [Disabled] [Enabled]



The following item appears only when you set **Log EFI Status Code** to [Enabled].

Convert EFI Status Codes to Standard Smbios Type [Disabled]

This option allows you to enable or disable converting of EFI Status Codes to Standard Smbios Type (Not all may be translated).
Configuration options: [Disabled] [Enabled]

4.11.2 View Smbios Event Log

Press <Enter> to view all smbios event logs.

4.12 Server Mgmt menu

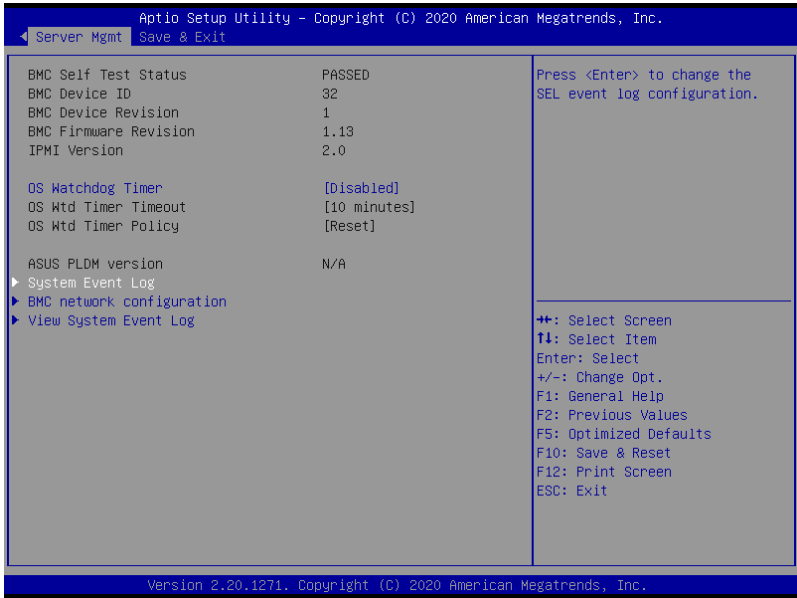

OS Watchdog Timer [Disabled]

This item allows you to start a BIOS timer which can only be shut off by Management Software after the OS loads.

Configuration options: [Disabled] [Enabled]



The following items are configurable only when **OS Watchdog Timer** is set to **[Enabled]**.

OS Wtd Timer Timeout [10 minutes]

Allows you to configure the length for the OS Boot Watchdog Timer.

Configuration options: [5 minutes] [10 minutes] [15 minutes] [20 minutes]

OS Wtd Timer Policy [Reset]

This item allows you to configure the how the system should respond if the OS Boot Watch Timer expires.

Configuration options: [Do Nothing] [Reset] [Power Down] [Power Cycle]

4.12.1 System Event Log

Allows you to change the SEL event log configuration.

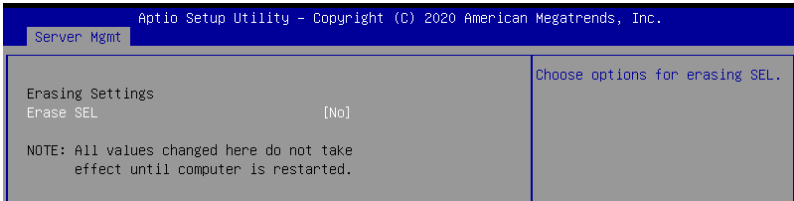

Erasing Settings

Erase SEL [No]

Allows you to choose options for erasing SEL.

Configuration options: [No] [Yes, On next reset] [Yes, On every reset]

4.12.2 BMC network configuration

The sub-items in this configuration allow you to configure the BMC network parameters.

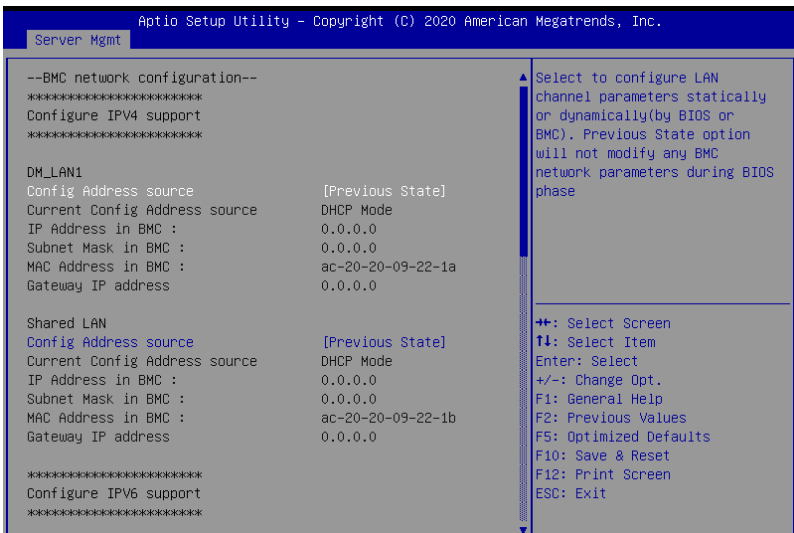

Navigate to the second page of the screen to see the rest of items in this menu by pressing the Up or Down arrow keys.



To quickly go to the last item of the second page, press the **Page Down** button. Press the **Page Up** button to go back to the first item in the first page.

IPV4

DM_LAN1 / Shared LAN

Configuration Address source [Previous State]

This item allows you to configure LAN channel parameters statistically or dynamically (by BIOS or BMC). Unspecified option will not modify any BMC network parameters during BIOS phase.

Configuration options: [Previous State] [Static] [DynamicBmcDhcp]

IPV6

DM_LAN1

IPV6 Support [Enabled]

Allows you to enable or disable LAN1 IPV6 Support.

Configuration options: [Disabled] [Enabled]



The following items appear only when **IPV6 Support** is set to **[Enabled]**.

Configuration Address source [Previous State]

This item allows you to configure LAN channel parameters statistically or dynamically (by BIOS or BMC). Unspecified option will not modify any BMC network parameters during BIOS phase.

Configuration options: [Previous State] [Static] [DynamicBmcDhcp]

Shared LAN

IPV6 Support [Enabled]

Allows you to enable or disable LAN2 IPV6 Support.

Configuration options: [Disabled] [Enabled]



The following items appear only when **IPV6 Support** is set to **[Enabled]**.

Configuration Address source [Previous State]

This item allows you to configure LAN channel parameters statistically or dynamically (by BIOS or BMC). Unspecified option will not modify any BMC network parameters during BIOS phase.

Configuration options: [Previous State] [Static] [DynamicBmcDhcp]

4.12.3 View System Event Log

This item allows you to view the system event log records.

4.13 Save & Exit menu

The Exit menu items allow you to save or discard your changes to the BIOS items.

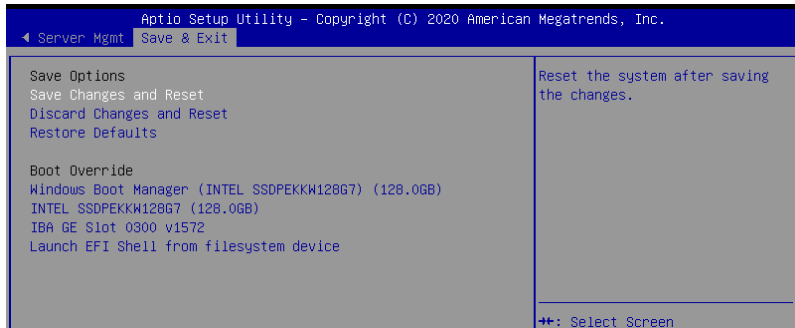

Pressing <Esc> does not immediately exit this menu. Select one of the options from this menu or <F10> from the legend bar to exit.

Save Changes and Reset

Exit System setup after saving the changes.

Discard Changes and Reset

Exit System setup without saving any changes.

Restore Defaults

Restore/load default values for all the setup options.

Boot Override

These items displays the available devices. The device items that appears on the screen depends on the number of devices installed in the system. Click an item to start booting from the selected device.

Chapter 5: RAID Configuration

5.1 Setting up RAID

The motherboard supports the Intel® Rapid Storage Technology enterprise Option ROM Utility with RAID 0, RAID 1, RAID 10, and RAID 5 support (for Windows OS and Linux).

5.1.1 RAID definitions

RAID 0 (Data striping) optimizes two identical hard disk drives to read and write data in parallel, interleaved stacks. Two hard disks perform the same work as a single drive but at a sustained data transfer rate, double that of a single disk alone, thus improving data access and storage. Use of two new identical hard disk drives is required for this setup.

RAID 1 (Data mirroring) copies and maintains an identical image of data from one drive to a second drive. If one drive fails, the disk array management software directs all applications to the surviving drive as it contains a complete copy of the data in the other drive. This RAID configuration provides data protection and increases fault tolerance to the entire system. Use two new drives or use an existing drive and a new drive for this setup. The new drive must be of the same size or larger than the existing drive.

RAID 10 is data striping and data mirroring combined without parity (redundancy data) having to be calculated and written. With the RAID 10 configuration you get all the benefits of both RAID 0 and RAID 1 configurations. Use four new hard disk drives or use an existing drive and three new drives for this setup.

RAID 5 stripes both data and parity information across three or more hard disk drives. Among the advantages of RAID 5 configuration include better HDD performance, fault tolerance, and higher storage capacity. The RAID 5 configuration is best suited for transaction processing, relational database applications, enterprise resource planning, and other business systems. Use a minimum of three identical hard disk drives for this setup.



If you want to boot the system from a hard disk drive included in a created RAID set, copy first the RAID driver from the support DVD to a floppy disk before you install an operating system to the selected hard disk drive.

5.1.2 Installing hard disk drives

The motherboard supports Serial ATA for RAID set configuration. For optimal performance, install identical drives of the same model and capacity when creating a disk array.

To install the SATA hard disks for RAID configuration:

1. Install the SATA hard disks into the drive bays following the instructions in the system user guide.
2. Connect a SATA signal cable to the signal connector at the back of each drive and to the SATA connector on the motherboard.
3. Connect a SATA power cable to the power connector on each drive.

5.1.3 Setting the RAID item in BIOS

You must set the RAID item in the BIOS Setup before you can create a RAID set from SATA hard disk drives attached to the SATA connectors supported by Intel® C242 chipset.

To do this:

1. Enter the BIOS Setup during POST.
2. Go to the **Chipset Menu > PCH-IO Configuration > SATA And RSTe Configuratrion**, then press <Enter>.
3. Set **SATA Mode** to **[RAID Mode]**.
4. Press <F10> to save your changes and exit the BIOS Setup.



Refer to Chapter 4 for details on entering and navigating through the BIOS Setup.

5.2 Intel® Rapid Storage Technology enterprise SATA/SSATA Option ROM Utility

The Intel® Rapid Storage Technology enterprise SATA/SSATA Option ROM utility allows you to create RAID 0, RAID 1, RAID 10 (RAID 1+0), and RAID 5 set from Serial ATA hard disk drives that are connected to the Serial ATA connectors supported by the Southbridge.



Before you proceed, ensure that you have installed the Serial ATA hard disk drives, and have set the correct SATA mode in the BIOS setup. You can refer to the **Installing hard disk drives**, and **Setting the RAID item in BIOS** sections in this manual for more information.

To launch the Intel® Rapid Storage Technology enterprise SATA/SSATA Option ROM utility:

1. Turn on the system.
2. During POST, press <Ctrl>+<I> to display the utility main menu.

```
Intel(R) Rapid Storage Technology enterprise - SATA Option ROM - 4.5.0.1012
Copyright (C) 2003-15 Intel Corporation. All Rights Reserved.

[ MAIN MENU ]
1. Create RAID Volume
2. Delete RAID Volume
3. Reset Disks to Non-RAID
4. Mark Disks as Spare
5. Exit

[ DISK/VOLUME INFORMATION ]

RAID Volumes:
None defined.

Physical Disks:
ID Drive Model Serial # Size Type/Status (Vol ID)
0 ST3300656SS HWA50000991753TR 279.3GB Non-RAID Disk
1 ST3300656SS 37VN00009846RAJ1 279.3GB Non-RAID Disk
2 ST3300656SS 397600009846UEDY 279.3GB Non-RAID Disk
3 ST3300656SS GWC50000991756G6 279.3GB Non-RAID Disk

[↑↓]-Select [ESC]-Exit [ENTER]-Select Menu
```

The navigation keys at the bottom of the screen allow you to move through the menus and select the menu options.



The RAID BIOS setup screens shown in this section are for reference only and may not exactly match the items on your screen.

5.2.1 Creating a RAID set

To create a RAID set:

1. From the utility main menu, select **1. Create RAID Volume** and press <Enter>.
2. Key in a name for the RAID set and press <Enter>.

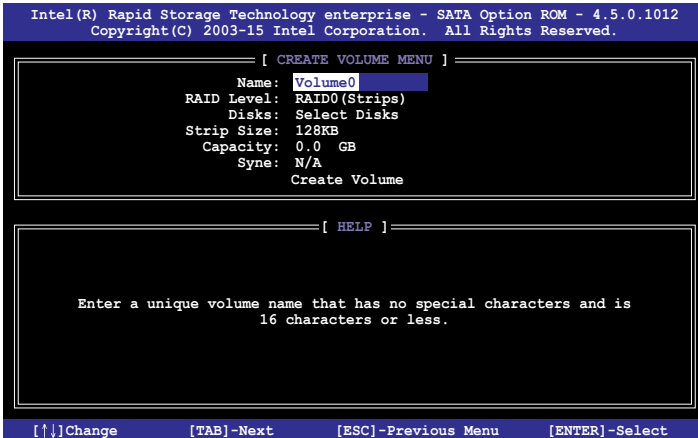

3. Press the up/down arrow keys to select a RAID Level that you wish to create then press <Enter>.
4. From the **Disks** item field, press <Enter> to select the hard disk drives that you want to include in the RAID set.

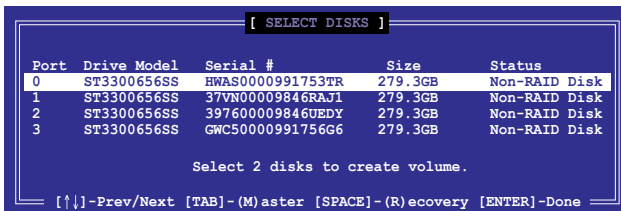

5. Use the up/down arrow keys to move the selection bar then press <Space> to select a disk. A small triangle before the Port number marks the selected drive. Press <Enter> when you are done.

6. Use the up/down arrow keys to select the stripe size for the RAID array (for RAID 0, 10 and 5 only) then press <Enter>. The available stripe size values range from 4 KB to 128 KB. The following are typical values:
RAID 0: 128KB
RAID 10: 64KB
RAID 5: 64KB



We recommend a lower stripe size for server systems, and a higher stripe size for multimedia computer systems used mainly for audio and video editing.

7. In the **Capacity** field item, key in the RAID volume capacity that you want to use and press <Enter>. The default value field indicates the maximum allowed capacity.
8. Press <Enter> to start creating the RAID volume.
9. From the following warning message, press <Y> to create the RAID volume and return to the main menu, or press <N> to go back to the **CREATE VOLUME** menu.

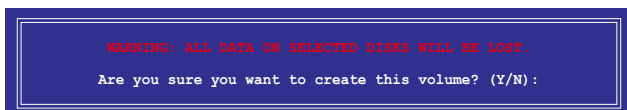

5.2.2 Deleting a RAID set



Take caution when deleting a RAID set. You will lose all data on the hard disk drives when you delete a RAID set.

To delete a RAID set:

1. From the utility main menu, select **2. Delete RAID Volume** and press <Enter>.
2. From the Delete Volume Menu, press the up/down arrow keys to select the RAID set you want to delete then press .

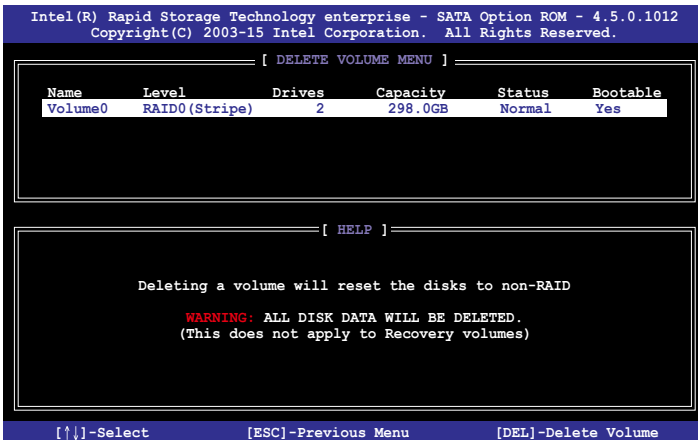

3. Press <Y> to confirm deletion of the selected RAID set and return to the utility main menu, or press <N> to return to the **DELETE VOLUME** menu.

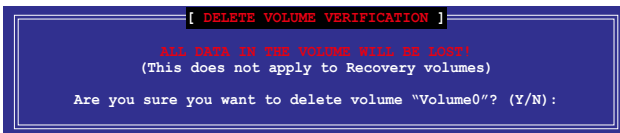

5.2.3 Resetting disks to Non-RAID



Take caution before you reset a RAID volume hard disk drive to non-RAID. Resetting a RAID volume hard disk drive deletes all internal RAID structure on the drive.

To reset a RAID set:

1. From the utility main menu, select **3. Reset Disks to Non-RAID** and press <Enter>.
2. Press the up/down arrow keys to select the drive(s) or disks of the RAID set you want to reset, then press <Space>. A small triangle before the Port number marks the selected drive. Press <Enter> when you are done.

```
[ RESET RAID DATA ]
Resetting RAID disk will remove its RAID structures
and revert it to a non-RAID disk.

WARNING: Formatting a disk causes all data on the disk to be lost.
(This does not apply to Recovery volumes)

Port  Drive Model  Serial #          Size      Status
---  -
0     ST3300656SS    HWAS0000991753TR 279.3GB  Member Disk
1     ST3300656SS    37VN00009846RAJ1 279.3GB  Member Disk

Select the disks that should be reset.

[↑↓]-Previous/Next [SPACE]-Selects [ENTER]-Selection Complete
```

3. Press <Y> in the confirmation window to reset the drive(s) or press <N> to return to the utility main menu.

5.2.4 Exiting the Intel® Rapid Storage Technology enterprise SATA/SSATA Option ROM utility

To exit the utility:

1. From the utility main menu, select **4. Exit** then press <Enter>.
2. Press <Y> to exit or press <N> to return to the utility main menu.

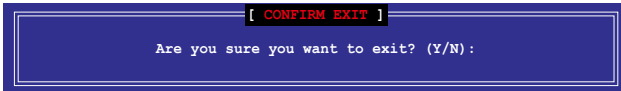

5.2.5 Rebuilding the RAID



This option is only for the RAID 1 set.

Rebuilding the RAID with other non-RAID disk

If any of the SATA hard disk drives included in the RAID 1 array failed, the system displays the status of the RAID volume as **"Degraded"** during POST. You can rebuild the RAID array with other installed non-RAID disks.

To rebuild the RAID with other non-RAID disk:

1. During POST, press <Ctrl>+<I> at the prompt to enter the Intel Rapid Storage Technology option ROM utility.
2. If there is a non-RAID SATA Hard Disk available, the utility will prompt you to rebuild the RAID. Press the up/down arrow keys to select the destination disk then press <Enter> to start the rebuilding process, or press <ESC> to exit.

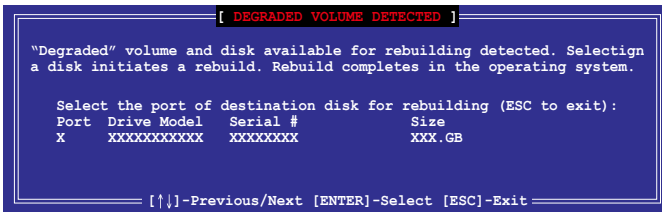

Select a destination disk with the same size as the original hard disk.

- The utility immediately starts rebuilding after the disk is selected. When done, the status of the degraded RAID volume is changed to **“Rebuild”**.

```

Intel(R) Rapid Storage Technology enterprise - SATA Option ROM - 4.5.0.1012
Copyright (C) 2003-15 Intel Corporation. All Rights Reserved.

[ MAIN MENU ]
1. Create RAID Volume
2. Delete RAID Volume
3. Reset Disks to Non-RAID
4. Mark Disks as Spare
5. Exit

[ DISK/VOLUME INFORMATION ]

RAID Volumes:
ID   Name      Levell      Strip      Size      *Data is Encrypted
1    Volume0   RAID1(Mirror) N/A        149.0GB   Status      Bootable
                                     Rebuild    Yes

Physical Devices:
Port  Drive Model  Serial #      Size      Type/Status (Vol ID)
1     ST3160812AS  9LS0F4HL     149.0GB   Member Disk(0)
2     ST3160812AS  3LS0JYL8     149.0GB   Member Disk(0)

Volumes with "Rebuild" status will be rebuilt within the operating system.

[↑]-Select      [ESC]-Exit      [ENTER]-Select Menu

```

- Press <Esc> to exit Intel Rapid Storage Technology and reboot the system.
- Select **Start > Programs > Intel Rapid Storage > Intel Rapid Storage Console** or click the **Intel Rapid Storage Technology** tray icon to load the Intel Rapid Storage Manager utility.
- From the **View** menu, select **Advanced Mode** to display the details of the Intel Rapid Storage Console.
- From the **Volumes view** option, select **RAID volume** to view the rebuilding status. When finished, the status is changed to **“Normal”**.

Rebuilding the RAID with a new hard disk

If any of the SATA hard disk drives included in the RAID array failed, the system displays the status of the RAID volume as **“Degraded”** during POST. You may replace the disk drive and rebuild the RAID array.

To rebuild the RAID with a new hard disk:

- Remove the failed SATA hard disk and install a new SATA hard disk of the same specification into the same SATA Port.



Select a destination disk with the same size as the original hard disk.

- Reboot the system then follow the steps in section **Rebuilding the RAID with other non-RAID disk**.

5.2.6 Setting the Boot array in the BIOS Setup Utility

You can set the boot priority sequence in the BIOS for your RAID arrays when creating multi-RAID using the Intel® Rapid Storage Technology enterprise SATA Option ROM utility.

To set the boot array in the BIOS:



Set at least one of the arrays bootable to boot from the hard disk.

1. Reboot the system and press to enter the BIOS setup utility during POST.
2. Go to the **Boot** menu and select the boot option priority.
3. Use up/down arrow keys to select the boot priority and press <Enter>. See the **Boot menu** section of Chapter 4 for more details.
4. From the **Exit** menu, select **Save Changes & Exit**, then press <Enter>.
5. When the confirmation window appears, select **Yes**, then press <Enter>.

5.3 Intel® Rapid Storage Technology enterprise (Windows)

The Intel® Rapid Storage Technology enterprise allows you to create RAID 0, RAID 1, RAID 10 (RAID 1+0), and RAID 5 set(s) from Serial ATA hard disk drives that are connected to the Serial ATA connectors supported by the Southbridge.



You need to manually install the Intel® Rapid Storage Technology enterprise utility on a Windows® operating system. Please refer to the installation instructions in Chapter 6.

To enter the Intel® Rapid Storage Technology enterprise utility under Windows operating system:

1. Turn on the system and go to the windows desktop.
2. Click the **Intel® Rapid Storage Technology enterprise** icon to display the main menu.

Your storage system is configured for data protection, increased performance and optimal data storage capacity. You can create additional volumes to further optimize your storage system.

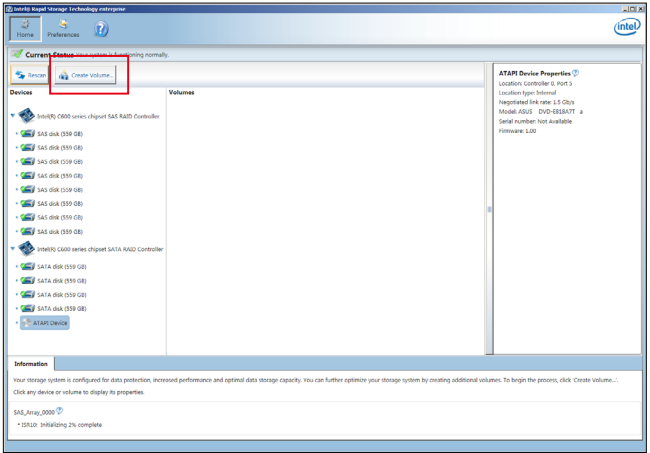

You can click **Rescan** to re-scan any attached hard disks.

5.3.1 Creating a RAID set

To create a RAID set:

1. From the utility main menu, select **Create Volume** and select volume type.
2. Click **Next**.

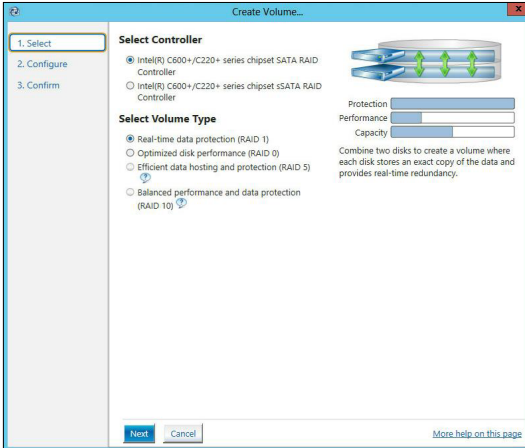

3. Enter a name for the RAID set, then select the array disks.
4. Select **Volume Size** tab, you can drag the bar to decide the volume size.
5. Click **Next**.

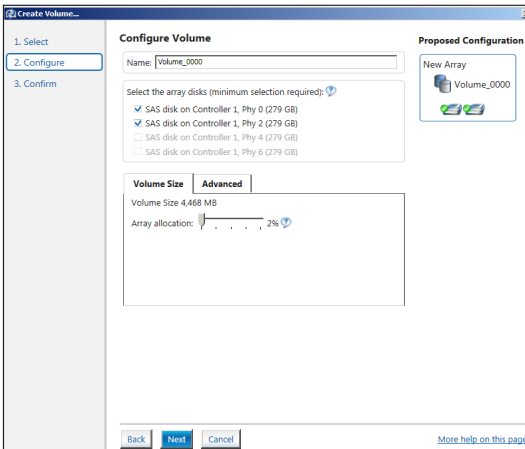

- If you do not want to keep the data on one of the selected disks, select **NO** when prompted.
- If you want to **Enable volume write-back cache** or **Initialize volume**, click **Advanced**.

6. Confirm the volume creation, then click **Create Volume** to continue.



This process could take a while depending on the number and size of the disks. You can continue using other applications during this time.

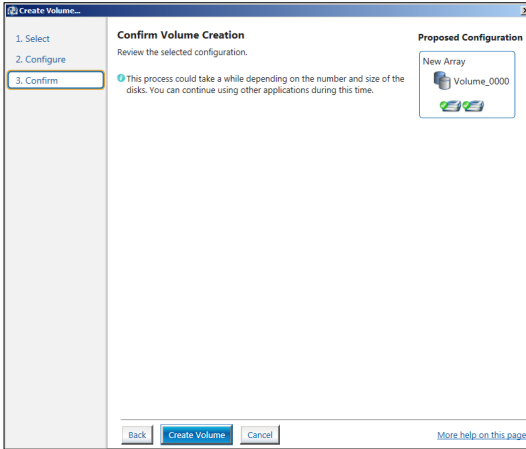

7. Wait until the process is completed, then click **OK** when prompted.

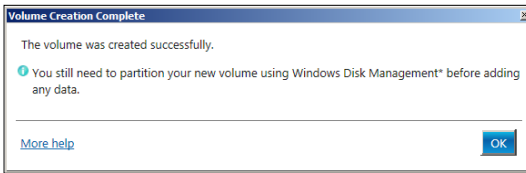

You still need to partition your new volume using Windows Disk Management before adding any data.

The RAID set is displayed in the **Volumes** list and you can change the settings in **Volume Properties**.

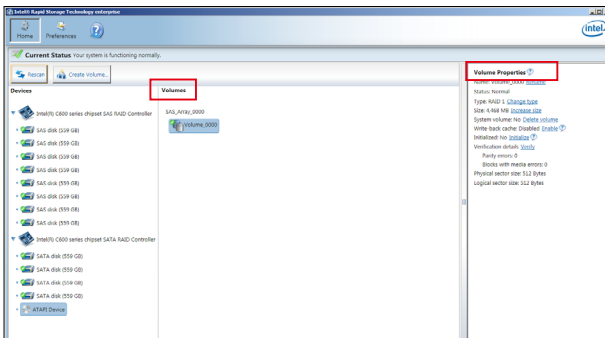

5.3.2 Changing a Volume Type

To change the volume type in **Volume Properties**:

1. Click the SATA array items you want to change in **Volumes** field.
2. From the **Volume Properties** field, select **Type:RAID 1 Change type**.

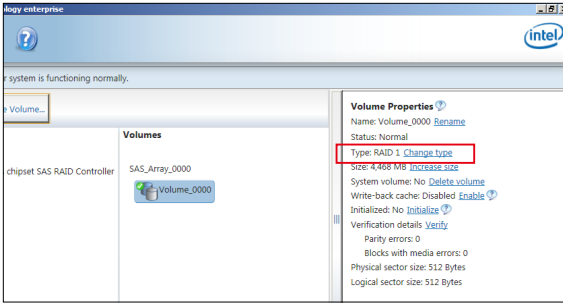

3. You can change the **Name**, **Select the new volume type**, and **Select additional disks to include in the new volume** if needed.
4. Select the **Data stripe size** for the RAID array (for RAID 0, 10 and 5 only), and click **OK**. The available stripe size values range from 4 KB to 128 KB. The following are typical values:
RAID 0: 128KB
RAID 10: 64KB
RAID 5: 64KB

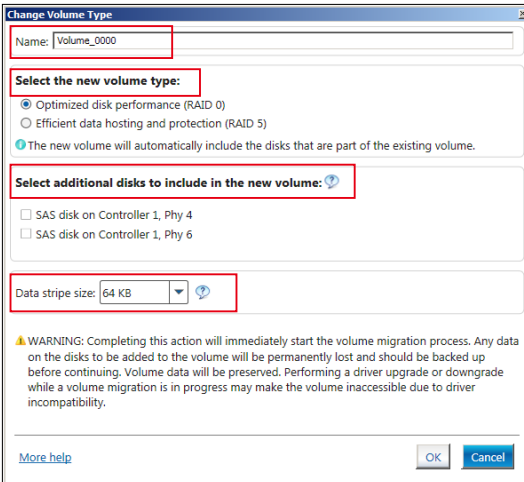

We recommend a lower stripe size for server systems, and a higher stripe size for multimedia computer systems used mainly for audio and video editing.

5.3.3 Deleting a volume



Be cautious when deleting a volume. You will lose all data on the hard disk drives. Before you proceed, ensure that you back up all your important data from your hard drives.

To delete a volume:

1. From the utility main menu, select the volume (exp. Volume_0000) in **Volumes** field you want to delete.

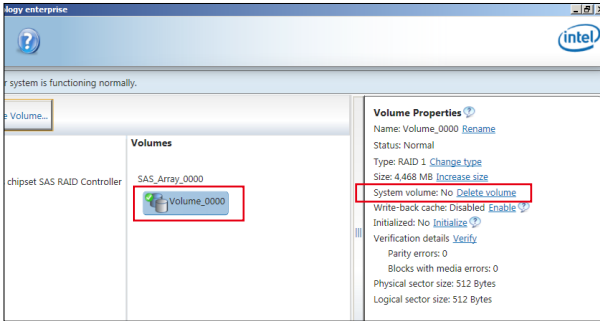

2. Select **Delete volume** in **Volume Properties** field. The following screen appears.

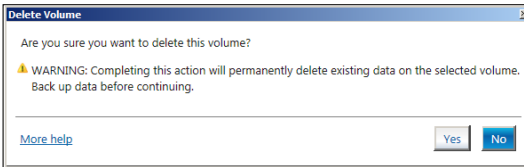

3. Click **Yes** to delete the volume and return to the utility main menu, or click **No** to return to the main menu.

5.3.4 Preferences

System Preferences

Allow you to set to show the notification area icon and show system information, warning, or errors here.

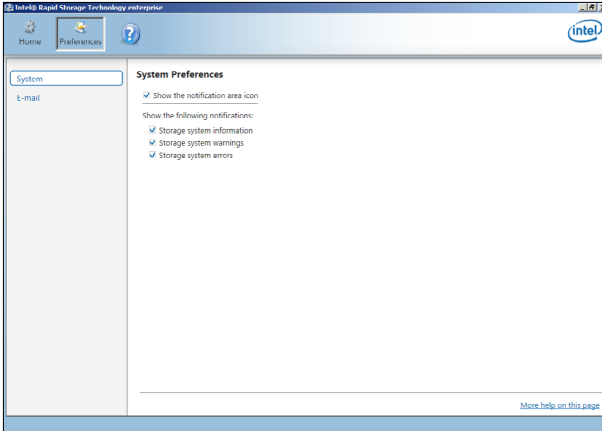

E-Mail Preferences

Allow you to set to sent e-mail of the following events:

- Storage system information
- Storage system warnings
- Storage system errors

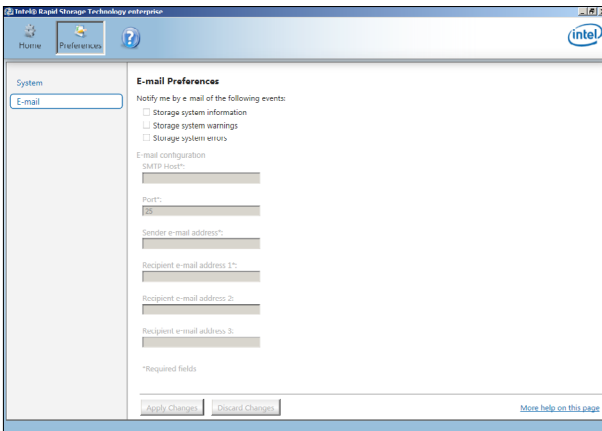

Chapter 6: Driver Installation

6.1 RAID driver installation

After creating the RAID sets for your server system, you are now ready to install an operating system to the independent hard disk drive or bootable array. This part provides the instructions on how to install the RAID controller drivers during OS installation.

6.1.1 Creating a USB flash drive with RAID drive

When installing Windows® Server OS, you can load the RAID driver from a USB flash drive. You can create a USB flash drive with RAID driver in Windows by copying the files from the support DVD to the USB flash drive.

To copy the RAID driver to a USB flash drive in Windows environment:

1. Place the motherboard support DVD in the optical drive.
2. Connect a USB flash drive to your system.
3. Click on the optical drive to browse the contents of the support DVD.
4. Click **Drivers > C24x INTEL RAID > Driver > Windows** and then copy the RAID driver folder to the USB flash drive.

6.1.2 Installing the RAID controller driver

During Windows® Server 2012 R2 or 2016 OS installation

To install the RAID controller driver when installing Windows® Server OS:

1. Boot the computer using the Windows® Server installation disc. Follow the onscreen instructions to start installing Windows® Server.
2. When prompted to choose a type of installation, click **Custom: Install Windows only (advanced)**.

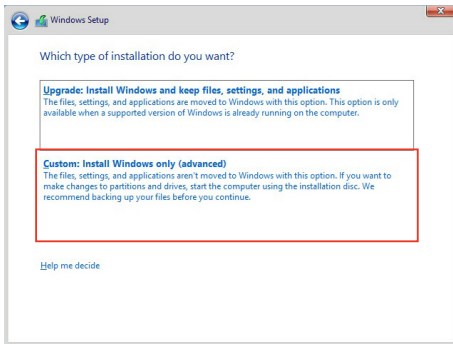

3. Click **Load Driver**.

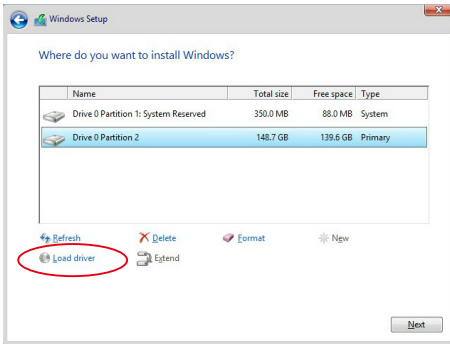

4. A message appears reminding you to insert the installation media containing the driver of the RAID controller driver (the installation media can be a CD, DVD, or USB flash drive).
- If you have only one optical drive installed in your system, eject the Windows OS installation disc and replace with the motherboard Support DVD into the optical drive.
 - Or you may connect a USB flash drive containing the RAID controller driver.

Click **Browse** to continue.

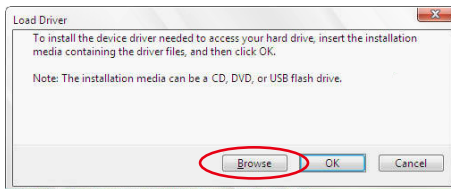

5. Locate the driver in the corresponding folder of the Support DVD or USB flash drive and then click **OK** to continue.
6. Select the RAID controller driver you need from the list and click **Next**.

7. When the system finishes loading the RAID driver,
 - Replace the motherboard Support DVD with the Windows Server installation disc.
 - Remove the USB flash drive.

Select the drive to install Windows and click **Next**.

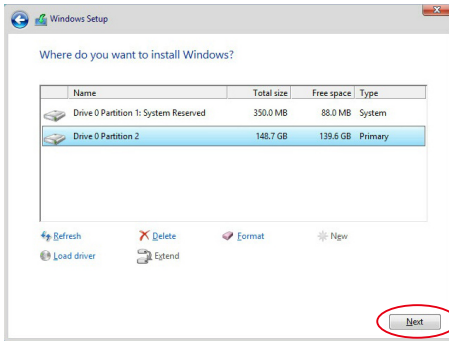

8. Setup then proceeds with the OS installation. Follow the onscreen instructions to continue.

6.2 Management applications and utilities installation

The support DVD that is bundled with your motherboard contains drivers, management applications, and utilities that you can install to maximize the features of your motherboard.



- The contents of the support DVD are subject to change at any time without notice. Visit the ASUS website (www.asus.com) for the latest updates on software and utilities.
- The support DVD is supported on Windows® Server 2012 R2 and Windows® Server 2016.

6.3 Running the Support DVD

When you place the support DVD into the optical drive, the DVD automatically displays the main screen if Autorun is enabled in your computer. By default, the Drivers tab is displayed.



If Autorun is NOT enabled in your computer, browse the contents of the support DVD to locate the file **Setup.exe**. Double-click the **Setup.exe** to run the support DVD.

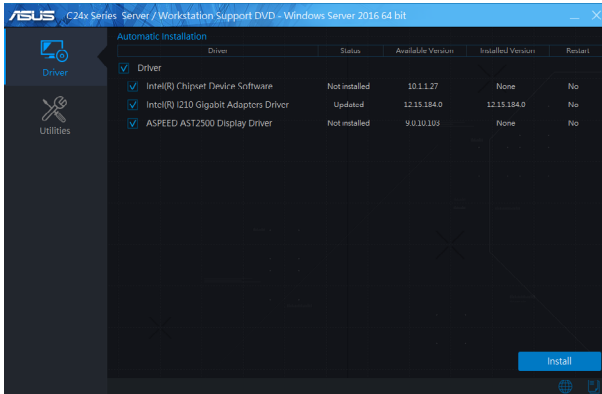

Onscreen display and content vary depending on the motherboard and chipset. The screenshots are provided for reference only.

6.4 Installing the system drivers

This section provides the instructions on how to install the system drivers. You will need to manually install the system drivers on a Windows® operating system.

To install the system drivers:

1. Restart the computer, and then log on with **Administrator** privileges.
2. Insert the support DVD into the optical drive. The support DVD automatically displays the **Driver** menu if Autorun is enabled in your computer.



If Autorun is NOT enabled in your computer, browse the contents of the support DVD to locate the file **Setup.exe**. Double-click the **Setup.exe** to run the support DVD.

3. Check the drivers that you would like to install, then select **Install**.

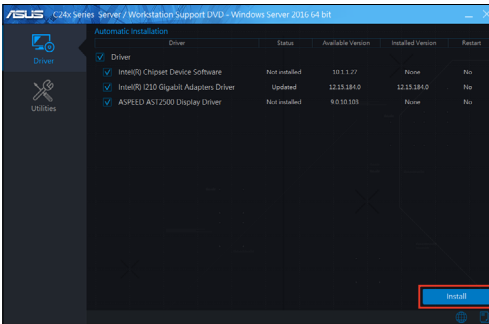

4. The installation window appears.

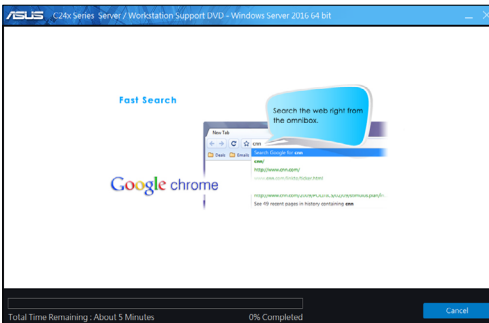

5. Follow the onscreen instructions to complete the installation.

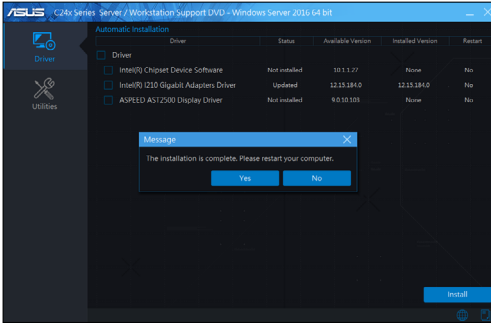

Appendix

P11C-I/NGFF2280 block diagram

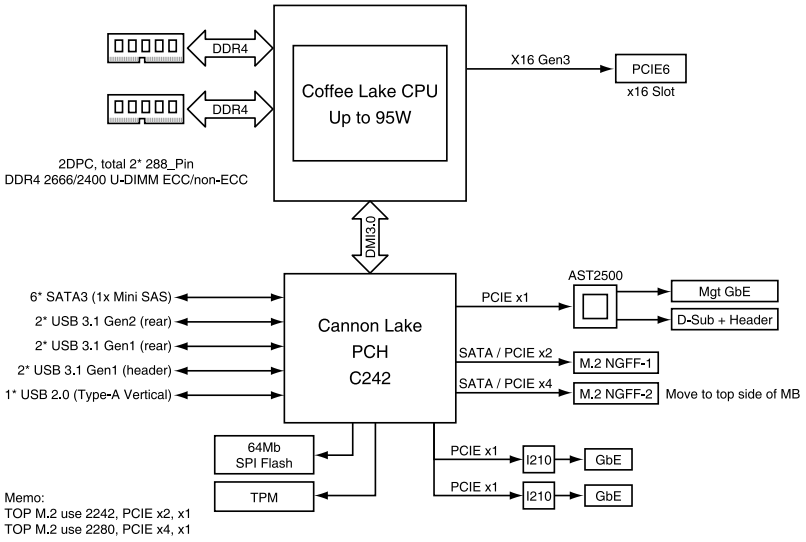

Notices

Federal Communications Commission Statement

This device complies with Part 15 of the FCC Rules. Operation is subject to the following two conditions:

- This device may not cause harmful interference, and
- This device must accept any interference received including interference that may cause undesired operation.

This equipment has been tested and found to comply with the limits for a Class B digital device, pursuant to Part 15 of the FCC Rules. These limits are designed to provide reasonable protection against harmful interference in a residential installation. This equipment generates, uses and can radiate radio frequency energy and, if not installed and used in accordance with manufacturer's instructions, may cause harmful interference to radio communications. However, there is no guarantee that interference will not occur in a particular installation. If this equipment does cause harmful interference to radio or television reception, which can be determined by turning the equipment off and on, the user is encouraged to try to correct the interference by one or more of the following measures:

- Reorient or relocate the receiving antenna.
- Increase the separation between the equipment and receiver.
- Connect the equipment to an outlet on a circuit different from that to which the receiver is connected.
- Consult the dealer or an experienced radio/TV technician for help.



The use of shielded cables for connection of the monitor to the graphics card is required to assure compliance with FCC regulations. Changes or modifications to this unit not expressly approved by the party responsible for compliance could void the user's authority to operate this equipment.

Compliance Statement of Innovation, Science and Economic Development Canada (ISED)

This device complies with Innovation, Science and Economic Development Canada licence exempt RSS standard(s). Operation is subject to the following two conditions: (1) this device may not cause interference, and (2) this device must accept any interference, including interference that may cause undesired operation of the device.

CAN ICES-3(B)/NMB-3(B)

Déclaration de conformité de Innovation, Sciences et Développement économique Canada (ISED)

Le présent appareil est conforme aux CNR d'Innovation, Sciences et Développement économique Canada applicables aux appareils radio exempts de licence. L'exploitation est autorisée aux deux conditions suivantes : (1) l'appareil ne doit pas produire de brouillage, et (2) l'utilisateur de l'appareil doit accepter tout brouillage radioélectrique subi, même si le brouillage est susceptible d'en compromettre le fonctionnement.

CAN ICES-3(B)/NMB-3(B)

Australia statement notice

From 1 January 2012 updated warranties apply to all ASUS products, consistent with the Australian Consumer Law. For the latest product warranty details please visit <https://www.asus.com/support>. Our goods come with guarantees that cannot be excluded under the Australian Consumer Law. You are entitled to a replacement or refund for a major failure and compensation for any other reasonably foreseeable loss or damage. You are also entitled to have the goods repaired or replaced if the goods fail to be of acceptable quality and the failure does not amount to a major failure.

If you require assistance please call ASUS Customer Service 1300 2787 88 or visit us at <https://www.asus.com/support>.

Declaration of compliance for product environmental regulation

ASUS follows the green design concept to design and manufacture our products, and makes sure that each stage of the product life cycle of ASUS product is in line with global environmental regulations. In addition, ASUS disclose the relevant information based on regulation requirements.

Please refer to <http://csr.asus.com/Compliance.htm> for information disclosure based on regulation requirements ASUS is complied with:

EU REACH and Article 33

Complying with the REACH (Registration, Evaluation, Authorization, and Restriction of Chemicals) regulatory framework, we publish the chemical substances in our products at ASUS REACH website at <http://csr.asus.com/english/REACH.htm>.

EU RoHS

This product complies with the EU RoHS Directive. For more details, see <http://csr.asus.com/english/article.aspx?id=35>

India RoHS

This product complies with the “India E-Waste (Management) Rules, 2016” and prohibits use of lead, mercury, hexavalent chromium, polybrominated biphenyls (PBBs) and polybrominated diphenyl ethers (PBDEs) in concentrations exceeding 0.1% by weight in homogenous materials and 0.01% by weight in homogenous materials for cadmium, except for the exemptions listed in Schedule II of the Rule.

Vietnam RoHS

ASUS products sold in Vietnam, on or after September 23, 2011, meet the requirements of the Vietnam Circular 30/2011/TT-BCT.

Các sản phẩm ASUS bán tại Việt Nam, vào ngày 23 tháng 9 năm 2011 trở về sau, đều phải đáp ứng các yêu cầu của Thông tư 30/2011/TT-BCT của Việt Nam.

Turkey RoHS

AEEEE Yönetmeliğine Uygundur

ASUS Recycling/Takeback Services

ASUS recycling and takeback programs come from our commitment to the highest standards for protecting our environment. We believe in providing solutions for you to be able to responsibly recycle our products, batteries, other components as well as the packaging materials. Please go to <http://csr.asus.com/english/Takeback.htm> for detailed recycling information in different regions.



DO NOT throw the motherboard in municipal waste. This product has been designed to enable proper reuse of parts and recycling. This symbol of the crossed out wheeled bin indicates that the product (electrical and electronic equipment) should not be placed in municipal waste. Check local regulations for disposal of electronic products.



DO NOT throw the mercury-containing button cell battery in municipal waste. This symbol of the crossed out wheeled bin indicates that the battery should not be placed in municipal waste.

Simplified EU Declaration of Conformity

English ASUSTeK Computer Inc. hereby declares that this device is in compliance with the essential requirements and other relevant provisions of related Directives. Full text of EU declaration of conformity is available at: www.asus.com/support

Français ASUSTek Computer Inc. déclare par la présente que cet appareil est conforme aux critères essentiels et autres clauses pertinentes des directives concernées. La déclaration de conformité de l'UE peut être téléchargée à partir du site Internet suivant: www.asus.com/support

Deutsch ASUSTeK Computer Inc. erklärt hiermit, dass dieses Gerät mit den wesentlichen Anforderungen und anderen relevanten Bestimmungen der zugehörigen Richtlinien übereinstimmt. Der gesamte Text der EU-Konformitätserklärung ist verfügbar unter: www.asus.com/support

Italiano ASUSTeK Computer Inc. con la presente dichiara che questo dispositivo è conforme ai requisiti essenziali e alle altre disposizioni pertinenti con le direttive correlate. Il testo completo della dichiarazione di conformità UE è disponibile all'indirizzo: www.asus.com/support

Русский Компания ASUS заявляет, что это устройство соответствует основным требованиям и другим соответствующим условиям соответствующих директив. Подробную информацию, пожалуйста, смотрите на www.asus.com/support

Български С настоящото ASUSTeK Computer Inc. декларира, че това устройство е в съответствие със съществените изисквания и другите приложими постановления на свързаните директиви. Пълният текст на декларацията за съответствие на ЕС с достъпен на адрес: www.asus.com/support

Hrvatski ASUSTeK Computer Inc. ovim izjavljuje da je ovaj uređaj skladan s bitnim zahtjevima i ostalim odgovarajućim odredbama vezanim direktiva. Cijeli tekst EU izjave o sukladnosti dostupan je na: www.asus.com/support

Čeština Společnost ASUSTeK Computer Inc. tímto prohlašuje, že toto zařízení splňuje základní požadavky a další příslušná ustanovení souvisejících směrnic. Plné znění prohlášení o shodě EU je k dispozici na adrese: www.asus.com/support

Dansk ASUSTeK Computer Inc. erklærer hermed, at denne enhed er i overensstemmelse med hovedkravene og andre relevante bestemmelser i de relaterede direktiver. Hele EU-overensstemmelseserklæringen kan findes på: www.asus.com/support

Nederlands ASUSTeK Computer Inc. verklaart hierbij dat dit apparaat voldoet aan de essentiële vereisten en andere relevante bepalingen van de verwante richtlijnen. De volledige tekst van de EU-verklaring van conformiteit is beschikbaar op: www.asus.com/support

Eesti Käesolevaga kinnitab ASUSTeK Computer Inc, et see seade vastab asjakohaste direktiivide olulistele nõuetele ja teistele asjassepuutuvatele sätetele. El vastusdeklaratsiooni täielik tekst on saadaval järgmisel aadressil: www.asus.com/support

Suomi ASUSTeK Computer Inc. ilmoittaa täten, että tämä laite on asiaankuuluvien direktiivien olennaisten vaatimusten ja muiden tätä koskevien säädösten mukainen. EU-yhdenmukaisuusilmoituksen koko teksti on luettavissa osoitteessa: www.asus.com/support

Ελληνικά Με το παρόν, η ASUSTeK Computer Inc. δηλώνει ότι αυτή η συσκευή συμμορφώνεται με τις θεμελιώδεις απαιτήσεις και άλλες σχετικές διατάξεις των Οδηγιών της ΕΕ. Το πλήρες κείμενο της δήλωσης συμμόρφότητας είναι διαθέσιμο στη διεύθυνση: www.asus.com/support

Magyar Az ASUSTeK Computer Inc. ezennel kijelenti, hogy ez az eszköz megfelel a kapcsolódó irányelvek lényeges követelményeinek és egyéb vonatkozó rendelkezéseinek. Az EU megfelelőségi nyilatkozat teljes szövege innen letölthető: www.asus.com/support

Latviski ASUSTeK Computer Inc. ar šo paziņo, ka šī ierīce atbilst saistošo Direktīvu būtiskajām prasībām un citiem citiem saistošajiem nosacījumiem. Pilns ES atbilstības paziņojuma teksts pieejams šeit: www.asus.com/support

Lietuviu „ASUSTeK Computer Inc.“ šiuo tvirtina, kad šis įrenginys atitinka pagrindinius reikalavimus ir kitas svarbias susijusių direktyvų nuostatas. Visą ES atitikties deklaracijos tekstą galima rasti: www.asus.com/support

Norsk ASUSTeK Computer Inc. erklærer herved at denne enheten er i samsvar med hovedsaklige krav og andre relevante forskrifter i relaterte direktiver. Fullstendig tekst for EU-samsvarserklæringen finnes på: www.asus.com/support

Polski Firma ASUSTeK Computer Inc. niniejszym oświadcza, że urządzenie to jest zgodne z zasadniczymi wymogami i innymi właściwymi postanowieniami powiązanych dyrektyw. Pełny tekst deklaracji zgodności UE jest dostępny pod adresem: www.asus.com/support

Português A ASUSTeK Computer Inc. declara que este dispositivo está em conformidade com os requisitos essenciais e outras disposições relevantes das Diretivas relacionadas. Texto integral da declaração da UE disponível em: www.asus.com/support

Română ASUSTeK Computer Inc. declară că acest dispozitiv se conformează cerințelor esențiale și altor prevederi relevante ale directivelor conexe. Textul complet al declarației de conformitate a Uniunii Europene se găsește la: www.asus.com/support

Srpski ASUSTeK Computer Inc. ovim izjavljuje da je ovaj uređaj u saglasnosti sa osnovnim zahtevima i drugim relevantnim odredbama povezanih Direktiva. Pun tekst EU deklaracije o usaglašenosti je dostupan da adresi: www.asus.com/support

Slovensky Spoločnosť ASUSTeK Computer Inc. týmto vyhlasuje, že toto zariadenie vyhovuje základným požiadavkám a ostatným príslušným ustanoveniam príslušných smerníc. Celý text vyhlásenia o zhode pre štáty EÚ je dostupný na adrese: www.asus.com/support

Slovenščina ASUSTeK Computer Inc. izjavlja, da je ta naprava skladna z bistvenimi zahtevami in drugimi ustreznimi določbami povezanih direktiv. Celotno besedilo EU-izjave o skladnosti je na voljo na spletnem mestu: www.asus.com/support

Español Por la presente, ASUSTeK Computer Inc. declara que este dispositivo cumple los requisitos básicos y otras disposiciones pertinentes de las directivas relacionadas. El texto completo de la declaración de la UE de conformidad está disponible en: www.asus.com/support

Svenska ASUSTeK Computer Inc. förklarar härmed att denna enhet överensstämmer med de grundläggande kraven och andra relevanta föreskrifter i relaterade direktiv. Fulltext av EU-försäkran om överensstämmelse finns på: www.asus.com/support

Українська ASUSTeK Computer Inc. заявляє, що цей пристрій відповідає основним вимогам та іншим відповідним положенням відповідних Директив. Повний текст декларації відповідності стандартам ЄС доступний на: www.asus.com/support

Türkçe ASUSTeK Computer Inc., bu aygıtın temel gereksinimlerle ve ilişkili Yönergelerin diğer ilgili koşullarıyla uyumlu olduğunu beyan eder. AB uygunluk bildirimini tam metni şu adreste bulunabilir: www.asus.com/support

Bosanski ASUSTeK Computer Inc. ovim izjavljuje da je ovaj uređaj usklađen sa bitnim zahtjevima i ostalim odgovarajućim odredbama vezanim direktiva. Cijeli tekst EU izjave o usklađenosti dostupan je na: www.asus.com/support

ASUS contact information

ASUSTeK COMPUTER INC.

Address 1F., No. 15, Lide Rd., Beitou Dist., Taipei City 112, Taiwan
Telephone +886-2-2894-3447
Fax +886-2-2890-7798
Web site <https://www.asus.com>

Technical Support

Telephone +86-21-38429911
Online Support <https://www.asus.com/support/Product/ContactUs/Services/questionform/?lang=en>

ASUSTeK COMPUTER INC. (Taiwan)

Address 1F., No. 15, Lide Rd., Beitou Dist., Taipei City 112, Taiwan
Telephone +886-2-2894-3447
Fax +886-2-2890-7798
Web site <https://www.asus.com/tw/>

Technical Support

Telephone +886-2-2894-3447 (0800-093-456)
Online Support <https://www.asus.com/support/Product/ContactUs/Services/questionform/?lang=zh-tw>

ASUSTeK COMPUTER INC. (China)

Address No. 5077, Jindu Road, Minhang District, Shanghai, China
Telephone +86-21-5442-1616
Fax +86-21-5442-0099
Web site <https://www.asus.com.cn>

Technical Support

Telephone +86-20-2804-7506 (400-620-6655)
Online Support <https://www.asus.com/support/Product/ContactUs/Services/questionform/?lang=zh-cn>

ASUS contact information

ASUS COMPUTER INTERNATIONAL (America)

Address 48720 Kato Rd., Fremont, CA 94538, USA
Fax +1-510-608-4555
Web site <https://www.asus.com/us/>

Technical Support

Support fax +1-812-284-0883
General support +1-812-282-2787
Online support <https://www.asus.com/support/Product/ContactUs/Services/questionform/?lang=en-us>

ASUS COMPUTER GmbH (Germany and Austria)

Address Harkortstrasse 21-23, 40880 Ratingen, Germany
Web site <https://www.asus.com/de/>
Online contact <https://www.asus.com/support/Product/ContactUs/Services/questionform/?lang=de-de>

Technical Support

Telephone (DE) +49-2102-5789557
Telephone (AT) +43-1360-2775461
Online support <https://www.asus.com/de/support>

ASUS Czech Service s.r.o. (Europe)

Address Na Rovince 887, 720 00 Ostrava – Hrabová,
Czech Republic
Telephone +420-596766888
Web site <https://www.asus.com/cz/>

Technical Support

Telephone +420-596-766-891
Fax +420-596-766-329
E-mail advance.rma.eu@asus.com
Online Support <https://www.asus.com/support/Product/ContactUs/Services/questionform/?lang=cs-cz>

ASUS contact information

ASUS Holland BV (The Netherlands)

Address Marconistraat 2, 7825GD EMMEN, The Netherlands
Web site <https://www.asus.com/nl/>

Technical Support

Telephone +31-(0)591-5-70292
Fax +31-(0)591-666853
E-mail advance.rma.eu@asus.com
Online Support <https://www.asus.com/support/Product/ContactUs/Services/questionform/?lang=nl-nl>

ASUS Polska Sp. z o.o. (Poland)

Address Ul. Postępu 6, 02-676 Warszawa, Poland
Web site <https://www.asus.com/pl/>

Technical Support

Telephone +48-225718033
Online Support <https://www.asus.com/support/Product/ContactUs/Services/questionform/?lang=pl-pl>

ASK-Service (Russia and CIS)

Address г.Москва, ул. Орджоникидзе, д.10, Россия
Telephone (495) 640-32-75
Web site <https://www.asus.com/ru/>

Technical Support

Telephone 008-800-100-ASUS (008-800-100-2787)
Online Support <https://www.asus.com/support/Product/ContactUs/Services/questionform/?lang=ru-ru>

FCC COMPLIANCE INFORMATION

Per FCC Part 2 Section 2.1077



Responsible Party: Asus Computer International
Address: 48720 Kato Rd, Fremont, CA 94538
Phone/Fax No: (510)739-3777/(510)608-4555

hereby declares that the product

Product Name : Motherboard
Model Number : P11C-I

compliance statement:

This device complies with part 15 of the FCC Rules. Operation is subject to the following two conditions: (1) This device may not cause harmful interference, and (2) this device must accept any interference received, including interference that may cause undesired operation.

Ver. 180620