



LSA LSI[®] Storage Authority Software

User Guide
Version 2.10

Table of Contents

How This Guide Is Organized.....	10
LSI Storage Authority Overview.....	11
Support Matrix.....	11
Technical Support.....	13
LSI Storage Authority Features.....	14
LSI Storage Authority Preinstallation, Postinstallation, and Upgrade Requirements.....	17
Preinstallation Requirements.....	17
OpenSLP.....	17
Upgrade Requirements.....	17
Browser Cache.....	18
Types of Installation.....	19
Gateway Installer.....	19
StandAlone Installer.....	20
DirectAgent Installer.....	20
Light Weight Monitor.....	20
Light Weight Agent Installer.....	20
Configuring HTTPS.....	21
Resetting Encryption Keys.....	22
Installing the LSI Storage Authority Software on the Microsoft Windows Operating System.....	23
Installing in Noninteractive Mode.....	27
Uninstalling in Interactive Mode.....	28
Uninstalling in Noninteractive Mode.....	28
Installing the LSI Storage Authority Software on the Linux Operating System.....	29
Installing in the Interactive Mode.....	29
Installing in the Noninteractive Mode.....	30
Uninstalling the LSI Storage Authority Software on the Linux Operating System.....	30
Adding a Digital Signature and Enabling ASLR and DEP for LSI Utilities.....	31
Adding a Digital Signature in a Windows Environment.....	31
Adding a Digital Signature in a Linux Environment.....	31
Managing Light Weight Agent.....	32
Installing LWA on VMware ESXi.....	32
Installing LWA on VMware ESXi 7.x.....	32
Installing LWA on VMware ESXi 8.x.....	32
Uninstalling LWA from VMware ESXi.....	33

Managing LSA and Web Services on VMware ESXi 7.x.....	33
Managing LSA and Web Services on VMware ESXi 8.x.....	34
Managing LSA on VMware ESXi Operating Systems.....	35
Managing Host Hardware RAID Controllers.....	37
Increasing the Memory Limit of the Host Hardware RAID Controller.....	37
Increasing the Polling Interval of the Host Hardware RAID Controller.....	37
Disabling the Host Hardware RAID Controller.....	37
Optimizing Event Notifications.....	38
Configuring the Provider on ESXi Servers.....	38
Configuring LSA on Gateway Servers for Optimizing Events.....	38
Configuring LSA on Gateway Servers to Get Real-Time Events.....	38
Configuring the Firewall on Various LSA Installers.....	39
Configuring the Firewall on Gateway/StandAlone Installer (Windows).....	39
Configuring the Firewall on Gateway/StandAlone Installer (Linux).....	39
Configuring the Firewall on InDirectAgent Installer.....	40
Collecting Logs with InDirectAgent SMIS-Based Management.....	40
Collecting Logs on Windows and Linux Operating Systems.....	41
Logout and Reboot Requirements on VMware Operating Systems.....	41
Behavior of Event History.....	41
Behavior of Event Monitoring.....	42
Limitations of Installation and Configuration.....	43
Upgrading and Downgrading the Firmware on IT Controllers (VMware).....	43
Differences in LSA for VMware ESXi.....	43
Performing Initial Configuration.....	45
Configuring LSA on LWA and LWM ESXi.....	45
Domain Authentication Behavior.....	45
Adding Translated Names in Windows.....	46
Adding Translated Names in Linux.....	46
Using LDAP Authentication.....	46
Accessing LSA over Network Address Translation.....	47
Changing the LSI Storage Authority Application Port Number.....	48
Hiding an Empty Backplane.....	48
Changing the nginx Web Server Port Numbers.....	49
Changing the nginx Read Timeout.....	49
Performing Initial Setup.....	50
Managing Servers from the Remote Server Discovery Page.....	50
Adding Managed Servers.....	51
Removing Managed Servers.....	52
Manually Discovering Servers.....	52

Alert Settings	54
Setting Up the Email Server	55
Server Dashboard	57
Controller Dashboard	60
Configuration	62
Creating a New Storage Configuration Using the Simple Configuration Option	62
Creating a New Storage Configuration Using the Advanced Configuration Option	63
Adding Physical Drives.....	67
Adding Hot Spares During Configuration Creation.....	67
Adding Virtual Drives.....	68
Clearing the Configuration	69
Importing or Clearing the Foreign Configurations	70
UNMAP Capability Feature	70
UNMAP Capability Feature Behavior.....	70
UNMAP Feature Support.....	71
Personality Management	73
Changing Personality Modes.....	73
Changing Behavior Modes.....	74
Profile Management	75
Changing Profiles.....	75
Background Operations Support	77
Managing Controllers	78
Viewing Controller Properties	78
Running a Consistency Check	80
Setting the Consistency Check Properties.....	81
Scheduling a Consistency Check.....	81
Device Reporting Order	83
Running a Patrol Read	83
Scheduling a Patrol Read.....	83
Starting a Patrol Read Operation.....	84
Stopping a Patrol Read Operation.....	85
Managing SAS Storage Link Speed	85
Managing PCIe Storage Lane Speed	87
Setting the Adjustable Task Rates	88
Managing Power-Save Settings	89
Enabling and Disabling SSD Guard	90
Discarding Pinned Cache	90
Downloading the TTY Log	91
Updating the Controller Firmware	91

Firmware Activation Status	93
Managing Factory Defaults	95
Drive Spin Up	95
Advanced Software	97
Activating Advanced Software	97
Advanced Software Status Summary.....	98
Activating a Trial Key.....	98
Activating an Unlimited Key over a Trial Key.....	99
Reusing the Activation Key.....	99
Application Scenarios and Messages.....	100
Securing Advanced Software	100
Configuring the Key Vault (Re-Hosting Process)	101
Implementing the Re-Hosting Process	102
Snapdump Feature	102
Snapdump Feature Support.....	102
Retrieving the Snapdump Output.....	103
Deactivating Trial Software	104
Using the CacheCade™ Pro 2.0 Feature	105
Creating a CacheCade Virtual Drive.....	105
Modifying the CacheCade Virtual Drive Properties.....	107
Enabling SSD Caching on a Virtual Drive.....	108
Disabling SSD Caching on a Virtual Drive.....	109
Clearing Configuration on Controllers that Have CacheCade Virtual Drives.....	109
Deleting a CacheCade – SSD Caching Virtual Drive.....	109
FastPath Advanced Software	110
SafeStore Encryption Services	110
Enabling Security.....	110
Changing Security Settings.....	112
Disabling Security.....	114
Importing or Clearing a Foreign Configuration – Security-Enabled Drives.....	114
Managing Drive Groups	115
Viewing Drive Group Properties	115
Adding a Virtual Drive to a Drive Group	116
RAID Level Migration	116
Migrating the RAID Level of a Drive Group.....	117
Adding Physical Drives to a Configuration.....	117
Removing Drives from a Configuration.....	118
Migrating the RAID Level without Adding or Removing Drives.....	119
Managing Virtual Drives	120

Viewing Virtual Drive Properties.....	120
Modifying Virtual Drive Properties.....	121
Start and Stop Locating a Virtual Drive.....	122
Erasing a Virtual Drive.....	123
Initializing a Virtual Drive.....	124
Starting Consistency Check on a Virtual Drive.....	124
Expanding the Online Capacity of a Virtual Drive.....	124
Deleting a Virtual Drive.....	127
Behavior of Virtual Drive Operations on VMware.....	127
Enabling the Schedule Panel Feature.....	127
Disabling the Schedule Panel Feature.....	128
Modifying the Time Limit of the Schedule Panel.....	128
Hiding and Unhiding a Virtual Drive or a Drive Group.....	128
Hiding a Virtual Drive.....	129
Unhiding a Virtual Drive.....	129
Hiding a Drive Group.....	129
Unhiding a Drive Group.....	130
Managing Physical Drives.....	131
Viewing Physical Drive Properties.....	131
Viewing Volatile Properties.....	133
Locating Tape Drives.....	134
Start and Stop Locating a Drive.....	134
Making a Drive Offline.....	134
Making a Drive Online.....	134
Replacing a Drive.....	135
Marking a Drive as a Missing Drive.....	136
Replacing a Missing Drive.....	137
Viewing Protected Drive Groups.....	137
Assigning Global Hot Spares.....	138
Removing Global Hot Spares.....	138
Assigning Dedicated Hot Spares.....	138
Rebuilding a Drive.....	139
Converting an Unconfigured Bad Drive to an Unconfigured Good Drive.....	139
Removing a Drive.....	140
Making Different Types of Drives.....	140
Making an Unconfigured Drive.....	140
Making a Good Drive.....	140
Making a JBOD Drive.....	141
Erasing a Drive.....	141
Erasing a Drive Securely.....	142

Sanitizing a Drive.....	143
Managing Hardware Components.....	146
Monitoring Energy Packs.....	146
Viewing Energy Pack Properties.....	146
Refreshing Properties.....	148
Setting Learn Cycle Properties.....	148
Starting a Learn Cycle Manually.....	149
Monitoring Enclosures.....	149
Viewing Enclosure Properties.....	149
Viewing Partner Enclosure Properties.....	150
Viewing Tape Drives.....	152
Show Events.....	153
Downloading Events.....	154
Clearing Events.....	154
Customizing the Theme of the LSI Storage Authority Software.....	155
Viewing Default Theme Settings.....	155
Customizing the Logo.....	155
Customizing the Header Background Image.....	156
Introduction to the Light Weight Monitor System.....	157
Overview.....	157
Supported Operating Systems.....	157
Alert Delivery Methods Based on Severity Levels.....	157
System Log.....	158
Email Notification.....	158
Time Synchronization.....	159
Installing the Light Weight Monitor System.....	160
Installing the LSI Storage Authority Software on the Windows Operating System through the LSA Master Setup.....	160
Installing the Light Weight Monitor on the Windows Operating System through the LSA Stand-Alone Installation.....	162
Uninstalling Light Weight Monitor Software on the Windows Operating System.....	162
Installing the Light Weight Monitor on the Linux Operating System.....	163
Uninstalling the Light Weight Monitor on the Linux Operating System.....	163
Installing Light Weight Monitor on the Oracle Solaris x86 Operating System.....	163
Uninstalling the Light Weight Monitor on the Oracle Solaris x86 Operating System.....	164
Configuring the Light Weight Monitor System.....	165
Setting Up the Email Server.....	165
Setting Up the Custom Facility Level in the System Log File for the Solaris x86 Operating System.....	167
Adding the Email Addresses of Alert Notification Recipients.....	168

Configuring Alert Settings.....	169
Changing the Default Alert Delivery Method for Each Severity Level.....	169
Changing the Alert Delivery Method for a Specific Event.....	170
Changing the Severity Level for a Specific Event.....	170
Introduction to RAID.....	172
RAID Components and Features.....	172
Drive Group.....	172
Physical Drive States.....	172
Virtual Drive.....	173
Virtual Drive States.....	173
Fault Tolerance.....	173
Multipathing.....	174
Wide Port.....	174
Consistency Check.....	174
Replace.....	175
Background Initialization.....	175
Patrol Read.....	176
Disk Striping.....	176
Disk Mirroring.....	176
Parity.....	177
Disk Spanning.....	178
Hot Spares.....	179
Disk Rebuilds.....	179
Rebuild Rate.....	180
Hot Swap.....	180
Enclosure Management.....	180
RAID Levels.....	180
Summary of RAID Levels.....	180
Selecting a RAID Level.....	181
RAID 0 Drive Groups.....	181
RAID 1 Drive Groups.....	182
RAID 5 Drive Groups.....	183
RAID 6 Drive Groups.....	184
RAID 10 Drive Groups.....	185
RAID 50 Drive Groups.....	186
RAID 60 Drive Groups.....	187
RAID Configuration Strategies.....	188
Maximizing Fault Tolerance.....	188
Maximizing Performance.....	189

Maximizing Storage Capacity.....	190
RAID Availability.....	191
RAID Availability Concepts.....	191
Configuration Planning.....	192
Possible Raid Levels.....	192
Events and Messages.....	193
Error Levels.....	193
HTTP Status Codes and Description.....	194
SAS Address Assignment Rule.....	196
Multi-Selection Threshold for Virtual and Physical Drives.....	197
Known Issues and Workarounds.....	198
LSA Features.....	201
LSA Features Differences.....	201
LSA Terminology Differences.....	204
Glossary.....	206
Revision History.....	211
Documentation Legal Notice.....	220

How This Guide Is Organized

The *LSA LSI Storage Authority Software User Guide* contains the following sections.

Section	Description
LSI Storage Authority Overview	Provides an overview of the LSI® Storage Authority, including monitoring and maintaining storage devices and the required hardware and software to run the application.
LSI Storage Authority Features	Outlines the LSI Storage Authority feature differences for MegaRAID™.
Types of Installation	Provides information on LSI Storage Authority installers and steps to install and uninstall the LSI Storage Authority.
Performing Initial Setup	Provides certain initial setups that you need to perform.
Server Dashboard	Provides information about the Server dashboard.
Controller Dashboard	Provides information about the Controller dashboard.
Configuration	Provides information on how to create and modify storage configurations on systems with Broadcom® controllers.
Background Operations Support	Provides information on background operations support, such as Pause, Resume, Abort, and so on.
Managing Controllers	Provides information on how to monitor the activity of all the controllers present in the system and the devices that are attached to them.
Advanced Software	Provides information on certain premium features that the LSI Storage Authority supports on MegaRAID SAS 24Gb/s RAID controllers.
Managing Drive Groups	Provides information on how to monitor the status of the drive groups and spanned drive groups.
Managing Virtual Drives	Provides information on how to perform various operations on the virtual drives.
Managing Physical Drives	Provides information on how to manage physical drives that are connected to the controller.
Managing Hardware Components	Provides information on managing hardware components.
Show Events	Provides information on how to view event logs.
Customizing the Theme of the LSI Storage Authority Software	Provides information on customizing the theme of the LSI Storage Authority, such as adding your company logo or changing the default colors.

LSI Storage Authority Overview

The LSI Storage Authority (LSA) is a web-based application that enables you to monitor, maintain, troubleshoot, and configure the Broadcom MegaRAID products.

The LSI Storage Authority graphical user interface (GUI) helps you to view, create, and manage storage configurations.

- **Monitoring and Configuring:** LSA lets you monitor the controllers and configure the drives on the controller. It displays the status of the controller cards, virtual drives, and physical drives on the controller. The device status icons are displayed on their respective pages to notify you if there are drive failures and other events that require your immediate attention. Real-time email notifications on the status of the server are sent based on your alert settings. The system errors and events are recorded and displayed in an event log file. You can also import or clear foreign configurations.
- **Maintaining:** Using LSA, you can perform system maintenance tasks, such as updating the controller firmware.
- **Troubleshooting:** LSA displays information that is related to drive failures, device failures, and so on. It also provides recommendations and displays contextual links, helping you to easily locate the drives and devices that have issues and troubleshoot them. You can also download a complete report of all the devices and their configurations, properties, and settings and send it to the Support Teams for further troubleshooting.
- **Personality Management:** The Personality Management solutions for MegaRAID controllers support multiple personality modes, including JBOD personality. For more information on Personality Management, see [Personality Management](#).

Support Matrix

This section provides the support requirements for the LSI Storage Authority software.

The following tables provide the hardware, software, and Arm-based server support requirements for the LSI Storage Authority software.

Table 1: Hardware and Software Support Matrix

Supported Items	Version
Supported hardware	<ul style="list-style-type: none"> • 9600 Family eHBA Adapters • 9660 Family RAID Adapters • 9670 Family RAID Adapters • MegaRAID 12Gb/s SAS RAID controllers and Integrated MegaRAID 12Gb/s SAS RAID controllers <ul style="list-style-type: none"> – SAS3916 based MegaRAID and iMR – SAS3908 based MegaRAID and iMR – SAS3816 based IOC and iMR – SAS3808 based IOC and iMR – SAS3516 based MegaRAID and iMR – SAS3108 based MegaRAID and iMR – SAS3008 based HBAs • Intel PCH C6XX and PCH X99 chipsets
Supported operating systems	<p>Microsoft</p> <p>It is recommended you keep the Microsoft Windows operating systems up to date.</p> <ul style="list-style-type: none"> • Windows Server 2022 • Windows Server 2019 • Windows 10 (RS5) • Windows 10 22 H2 • Windows Client 11 22 H2 • Windows Client 11 <p>Linux</p> <ul style="list-style-type: none"> • Red Hat Enterprise Linux 9.2 (RTOS) • Red Hat Enterprise Linux 9.1 • Red Hat Enterprise Linux 9.0 • Red Hat Enterprise Linux 9.0 (RTOS) • Red Hat Enterprise Linux 8.8 • Red Hat Enterprise Linux 8.7 • Red Hat Enterprise Linux 8.6 • Red Hat Enterprise Linux 8.6 (RTOS) • Red Hat Enterprise Linux 8.5 • SUSE Linux Enterprise Server 15 SP5 • SUSE Linux Enterprise Server 15 SP4 • SUSE Linux Enterprise Server 15 SP3 • SUSE Linux Enterprise Server 15 SP2 <p>VMware</p> <ul style="list-style-type: none"> • VMware ESXi 8.0 U1 • VMware ESXi 8.0 • VMware ESXi 7.0 U3c • VMware ESXi 7.0 U2 • VMware ESXi 7.0 U1 <p>For SMIS-based LSA management of VMware servers, the following 6.7 uX OS versions are supported:</p> <ul style="list-style-type: none"> • VMware ESXi 6.7 U3 • VMware ESXi 6.7 U2 • VMware ESXi 6.7 U1 <p>Ubuntu</p> <ul style="list-style-type: none"> • Ubuntu 22.04 LTS • Ubuntu 20.04 LTS

Supported Items	Version
Supported web browsers	<ul style="list-style-type: none"> • Microsoft Edge 94.0 and above • Mozilla Firefox version 89.0 and above • Google Chrome Version 90 and above
Supported networks	<ul style="list-style-type: none"> • Internet Protocol versions 4 and 6 • Network Address Translation (NAT) • Lightweight Directory Access Protocol (LDAP) • Domain • HTTP, HTTPS
Supported languages	<ul style="list-style-type: none"> • English See Domain Authentication Behavior for non-English server support.

Table 2: Arm-based Server Support

Adapters Supported	Operating Systems Supported
<ul style="list-style-type: none"> • 9660 Family RAID Adapters • 9670 Family RAID Adapters 	Linux <ul style="list-style-type: none"> • Red Hat Enterprise Linux 9.2 • Red Hat Enterprise Linux 9.1 • Red Hat Enterprise Linux 9.0 • Red Hat Enterprise Linux 8.7 • Red Hat Enterprise Linux 8.6 • Red Hat Enterprise Linux 8.5 • SUSE Linux Enterprise Server 15 SP5 • SUSE Linux Enterprise Server 15 SP4 • SUSE Linux Enterprise Server 15 SP3
	Ubuntu <ul style="list-style-type: none"> • Ubuntu 22.04 LTS • Ubuntu 20.04 LTS

Technical Support

For assistance with running or configuring the LSI Storage Authority, contact a Broadcom Technical Support representative.

Click the following link to access the Broadcom Technical Support page:

[REQUEST TECHNICAL SUPPORT](#)

From this page, you can call a Technical Support representative, or submit a new service request and view its status.

Phone Support: [Call Us For Storage Support](#)

1-800-633-4545 (North America)

00-800-5745-6442 (International)

+ 49 (0) 8941 352 0123 (Germany)

LSI Storage Authority Features

The following tables outline the LSA features for MegaRAID controllers with respect to software features and firmware features.

IMPORTANT

Feature support varies based on your software version. LSA displays the features and operations that are currently available.

Table 3: Firmware Features

Feature Name	MegaRAID
RAID level	RAID 0, RAID 1, RAID 5, RAID 6, RAID 10, RAID 50, and RAID 60
Maximum configurable physical drives	240
Maximum spans	8
Maximum virtual drives	240
Dimmer switch	DS-I and DS-II
Maximum media errors	256
Strip size support	64 KiB and 256 KiB
Maximum VD's per drive group	16
Multipath	Yes
Controller reset support	Yes

Table 4: Software Features

Feature Name	Description
LDAP authentication	Supported network authentication protocol.
Server discovery and managing servers	Ability to set up a list of servers to monitor and manage.
Server dashboard	Displays the overall summary of the server and devices that are attached to it.
Controller dashboard	Interface in which you can perform controller-related actions and can view all the information pertaining to a controller.
Simple configuration	Specifies a limited number of settings and has the system select drives for you.
Advanced configuration	Allows you to choose additional settings and customize virtual drive creation.
Foreign configuration (import/clear)	A RAID configuration that exists on a replacement set of drives that you install in a computer system.
Clear configuration	Clears all existing configurations on a selected controller.
Update firmware	Updates the controller firmware.
Online firmware update	Updates the firmware while the system is online.
Controller Operations	

Feature Name	Description
Setting consistency check properties	Sets the consistency check properties.
Scheduling consistency check	Schedules a consistency check.
Setting patrol read properties	Sets the patrol read properties.
Starting patrol read	Starts a patrol read.
Stopping patrol read	Stops a patrol read.
Managing link speed	Changes the link speed between the controller and an expander or between the controller and a drive that is directly connected to the controller
Setting adjustable task rates	Sets the adjustable task rates.
Manage power-save settings	Manages the power-save settings to reduce power consumption of the devices that are connected to a controller.
Enable and disable SSD Guard™	Enables or disables the SSD Guard feature.
Enable and disable security	Enables or disables controller security.
Change drive security	Changes the drive security settings. Drive security settings cannot be changed when EKM is enabled.
Discarding preserved cache	Discards the controller data preserved from the virtual drive. This option is only available if pinned cache is present on the controller.
Background operations support	Pause, Resume, Abort, Pause All, Resume All, and Abort All features that enhance the functionality where the background operations running on a physical drive or a virtual drive can be paused for some time, and resumed later.
Personality management	Allows you to switch between different personality modes that are supported by your firmware.
Advanced Software Features	
FastPath	A high-performance I/O accelerator for SSD arrays that are connected to a MegaRAID controller card.
SafeStore™	Used to secure drive data from unauthorized access or modification resulting from theft, loss, or repurposing of drives.
RAID 5 and RAID 6	RAID 5 uses disk striping and parity data across all drives (distributed parity) to provide high data throughput, especially for small random access. RAID 6 uses distributed parity, with two independent parity blocks per stripe, and disk striping. A RAID 6 virtual drive can survive the loss of any two drives without losing data. A RAID 6 drive group, which requires a minimum of three drives, is similar to a RAID 5 drive group. Blocks of data and parity information are written across all drives. The parity information recovers the data if one or two drives fail in the drive group.
Modify drive group	Allows you to add, remove, or directly change the RAID level.
Secure using FDE	Secure a drive using Full-disk encryption (FDE).
Virtual Drive Operations	
Virtual drive settings and modifying virtual drive properties	Allows you to set and modify virtual drive properties.
Start and stop locating a virtual drive	Identifies a virtual drive within a disk enclosure.

Feature Name	Description
Erasing a virtual drive	Overwrites user-accessible locations or deletes a virtual drive.
Initializing a virtual drive	Initializes a virtual drive after completing the configuration process.
Starting consistency check on a virtual drive	Starts a consistency check on a virtual drive.
Deleting a virtual drive	Deletes virtual drives on a controller to reuse that space for new virtual drives.
Physical Drive Operations	
Assign global hot spare	Assigns a global hot spare to replace a failed physical drive in a redundant array.
Remove a global hot spare	Removes a global hot spare and lists the drive in the Unconfigured Drives section.
Assign a dedicated hot spare	Assigns dedicated hot spare drives to provide protection to one or more specified drive groups on the controller
Remove a dedicated hot spare	Removes a dedicated hot space and lists the drive in the Unconfigured Drives section.
Start and stop a locating drive	Identifies a physical drive by making their LEDs blink.
Making a drive online and offline	Changes the state of a physical drive.
Replacing a drive	Replaces a failing or failed drive.
Rebuilding a drive	Automatically rebuilds the data onto a hot spare to prevent data loss if a drive fails.
Prepare for removal	Prepares a physical drive for removal by spinning the drive into a power save mode.
Erasing a drive	Erases data on non-SEDs (normal HDDs).
Instant secure erase	Erases data from encrypted drives.
Converting an Unconfigured Bad drive to an Unconfigured Good drive	Converts an Unconfigured Bad drive to an Unconfigured Good drive.
Make an Unconfigured Good drive	Changes the status of a JBOD drive to an Unconfigured Good drive.
Make a JBOD and delete a JBOD	Changes the status of an Unconfigured Good drive to a JBOD drive.
Energy Pack Operations	
Auto Learn	Calibration operation that the controller performs to determine the condition of the energy pack.
Event Logs	
Viewing event logs	Views event logs, which contain information about the activity and performance of the server and all of the controller cards that are attached to the server.

LSI Storage Authority Preinstallation, Postinstallation, and Upgrade Requirements

This section describes the tasks that you must complete before you install, after the installation is complete, and while upgrading the LSI Storage Authority.

- [Preinstallation Requirements](#)
- [Upgrade Requirements](#)

Preinstallation Requirements

You must complete the following task before installing LSI Storage Authority.

If you want to access any other server with a particular gateway, ensure that you have installed the same version of LSA on both systems.

NOTE

You must stop LSA services if configuring a SAS 3.5 controller pass-through using DDA in a Windows environment.

OpenSLP

Service Location Protocol (SLP) is a process by which nodes on a network and select services and resources can be discovered.

The SLP process is dynamic and requires little or no static configuration. OpenSLP is an open source implementation of SLP, suitable for commercial and noncommercial applications.

From an LSA perspective, OpenSLP requires multicasting functionality to discover the servers that are connected over a subnet. For the **Remote Server Discovery** page to display all the registered servers, ensure that the servers are connected to a network configuration that supports multicasting.

If OpenSLP Is Not Installed

No action is required. With the latest versions of LSA, OpenSLP is bundled within the LSA package itself. While installing LSA, ensure that you select the option to install OpenSLP, and LSA seamlessly installs the required version of OpenSLP.

If OpenSLP Is Already Installed Before Installing LSA

If an instance of OpenSLP is already installed, LSA 2.2 and later packages skip installing OpenSLP.

An Instance of OpenSLP Was Already Installed, but LSA Is Unable to Display All the Registered Servers from the Remote Discovery Page

Restart the SLPD Services and LSA Service if LSA does not discover the servers from the **Remote Discovery** page.

Uninstalling or Canceling an LSA Installation

OpenSLP remains on the system if LSA is uninstalled or the LSA installation is canceled.

Upgrade Requirements

The following task must be completed while upgrading the LSI Storage Authority.

Browser Cache

Clear the browser cache on the client on which you are using LSA for the following reasons.

- If you are upgrading from a previous version of LSA.
- To clear the saved passwords, so passwords are not saved in the browser.

Types of Installation

This section provides information on the different types of LSI Storage Authority installers.

- Gateway
- StandAlone
- DirectAgent
- Light Weight Monitor (LWM)
- Light Weight Agent (LWA) Installer

The following table provides more information on each of these installers and their associated advantages.

Table 5: Types of Installers and Associated Support

Feature	Gateway Installer	StandAlone Installer	DirectAgent Installer	Light Weight Agent (LWA) Installer – ESXi Server Support
Permits discovery of other servers that run the LSI Storage Authority software	Yes	No	No	No
Permits self-registration using OpenSLP and has an interface for server discovery detection from the network	Yes	Yes Note: No interface exists for remote server discovery.	No	No
Allows the management of servers from the list of discovered servers through the user interface (UI)	Yes	No	No	No
Provides capability to configure LDAP information	Yes	Yes	No	No
Provides server monitoring capabilities and helps to monitor the health of the server and alerts the end user of any issues with event logs and email notifications	Yes	Yes	Yes	Yes

NOTE

In a new LSA installation, LSA processes only the last 30 events and performs the corresponding alert delivery.

Gateway Installer

The Gateway installer has the following components:

- A backend with local agent and remote agent management capabilities
- A monitor with remote monitoring capability
- A client with remote and managed server capabilities

The Gateway installer has the following features:

- Permits discovery of other servers that run the LSI Storage Authority.
- Permits self-registration using OpenSLP and has an interface for server discovery detection from the network.
- Allows you to manage the servers from the list of discovered servers through the user interface.

StandAlone Installer

The StandAlone installer has the following components:

- A backend with a local agent (without remote agent management capability) to support ESXi 7.x and ESXi 8.x.
- A monitor (without remote monitoring capability).
- A client (without remote and managed server capabilities).

The StandAlone installer has the following features and limitations:

- Does not permit the discovery of other hosts that are running the LSI Storage Authority.
- Permits self-registration of the current host using OpenSLP but does not have any interface for server discovery detection from the network.
- Provides capability to configure LDAP information.
- Does not permit adding managed servers through the UI.

DirectAgent Installer

The DirectAgent installer has the following components:

- A backend with local agent and a monitor component.
- A thin agent, which supports discovery (using SLP), authentication, and DCMD tunneling.

Light Weight Monitor

The Light Weight Monitor has the following benefits:

- Provides server monitoring capabilities.
- Light Weight Monitor (LWM) monitors the status of the controller cards, virtual drives, drives, and other devices on the server.
- Alerts you of any issues that require immediate attention with system logs and real-time email notifications (based on the alert settings).

Light Weight Agent Installer

The Light Weight Agent installer has the following components:

- A backend with a local agent (without remote agent management capability) to support ESXi 7.x.
- A monitor (without remote monitoring capability).
- A client (without remote and managed server capabilities).

The Light Weight Agent installer has the following features and limitations:

- Does not permit the discovery of other hosts that are running the LSI Storage Authority.
- Does not permit self-registration of the current host using OpenSLP and does not have any interface for server discovery detection from the network.
- Does not provide capability to configure LDAP information.
- Does not permit to add managed servers through the UI.

Configuring HTTPS

This section provides instructions on how to configure HTTPS.

To configure HTTPS, perform the following steps:

1. Stop **LSAService** and **NginxService** in Windows and **/etc/init.d/LsiSASH stop** in Linux.
2. Replace the `nginx.conf` file with `LSA_HOME\server\conf`.

IMPORTANT

In Windows operating systems, the `LSA_HOME` directory is accessible only by administrators.

3. Change the `nginx_default` value in the `nginx.conf` file to the `Web Server Port` value that the user selected during the LSA installation.
If necessary, change the same value in multiple places in the same file.
4. Change the `LSA_Default` value in the `nginx.conf` file to the `LSA Server Port` value that the user selected during the LSA installation.
If necessary, change the same value in multiple places in the same file.
5. Place `ssl.crt` and `ssl.key` into `LSA_HOME\server\conf`.
6. Go to the `LSA_HOME\conf` directory and change the `protocol_type` value to 1 (HTTPS) in `LSA.conf`.
7. Start **NginxService** and **LSAService** in Windows and **/etc/init.d/LsiSASH start** in Linux.
8. From the `<LSA_HOME>` directory, open the `startupLSAUI.bat` file, and change `start http` to `start https`.

NOTE

When the certificate and key files are created, rename them to `ssl.crt` and `ssl.key`.

To create your own SSL self-signed certificate, see http://www.akadia.com/services/ssh_test_certificate.html.

Resetting Encryption Keys

This section provides information on how to reset encryption keys.

LSA maintains sensitive data in an encrypted format. To encrypt data, LSA uses an AES algorithm with a key pair.

IMPORTANT

In Windows operating systems, the `LSA_HOME` directory is accessible only by administrators.

NOTE

Ensure that the user has administrative privileges before attempting to reset the key pair.

To change the key pair, use the following procedure:

1. Stop the LSA service.
 - a) Launch the command prompt in Windows.
 - b) To stop the LSA service, use the `sc stop LSAService` command.

NOTE

To stop the LSA service in Linux, use the `LSA.sh` command.

2. Enter the `$LSA_HOME/LSA.exe -rekey` command.

LSA will automatically delete the old keys and encrypt the sensitive data with a new key pair.
3. Start the LSA service.
 - a) Launch the command prompt in Windows.
 - b) To start the LSA service, use the `sc start LSAService` command.

Installing the LSI Storage Authority Software on the Microsoft Windows Operating System

This section provides the procedure for installing LSI Storage Authority Software on the Microsoft Windows operating system.

IMPORTANT

The `LSA_HOME` directory is only accessible by administrators.

Perform the following steps to install the LSI Storage Authority.

1. Run the LSI Storage Authority `setup.exe` file.
The **InstallShield Wizard** dialog appears.

Figure 1: InstallShield Wizard Dialog

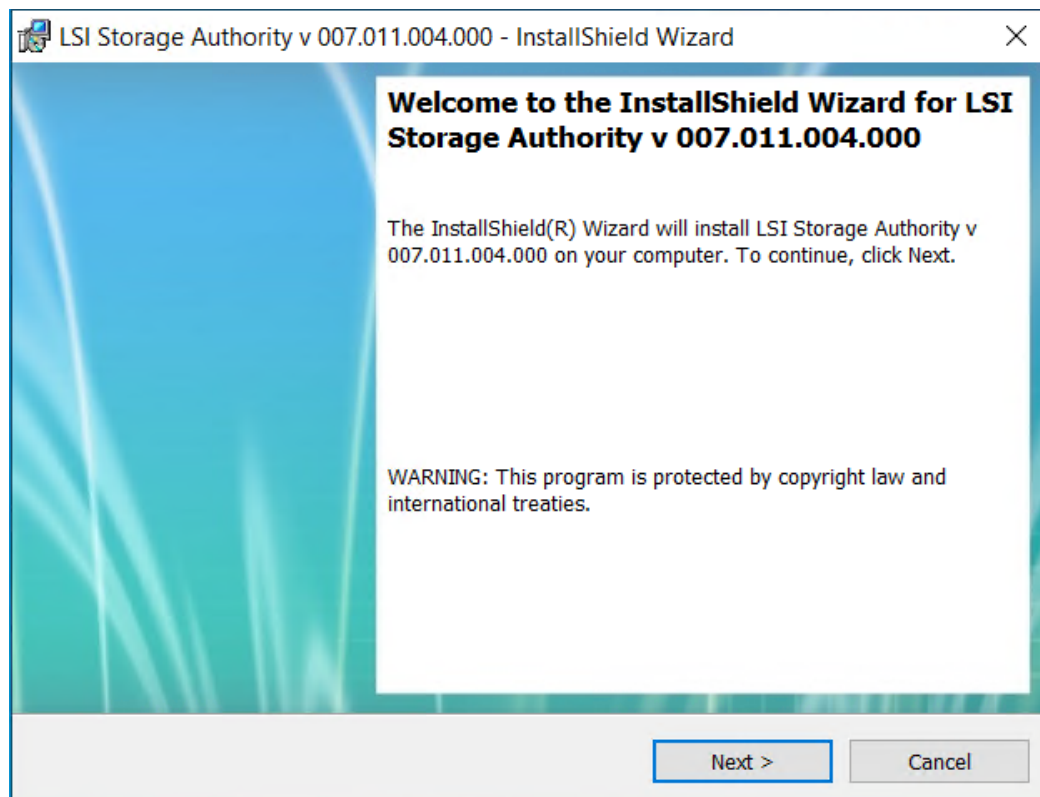

2. Click **Next**.
The **License Agreement** dialog appears.
3. Read the agreement and select the **I accept the terms in the license agreement** radio button, and click **Next**.
The **Customer Information** dialog appears.
4. Enter your user name and the organization name, and click **Next**.
The **Port Configuration Settings** dialog appears.

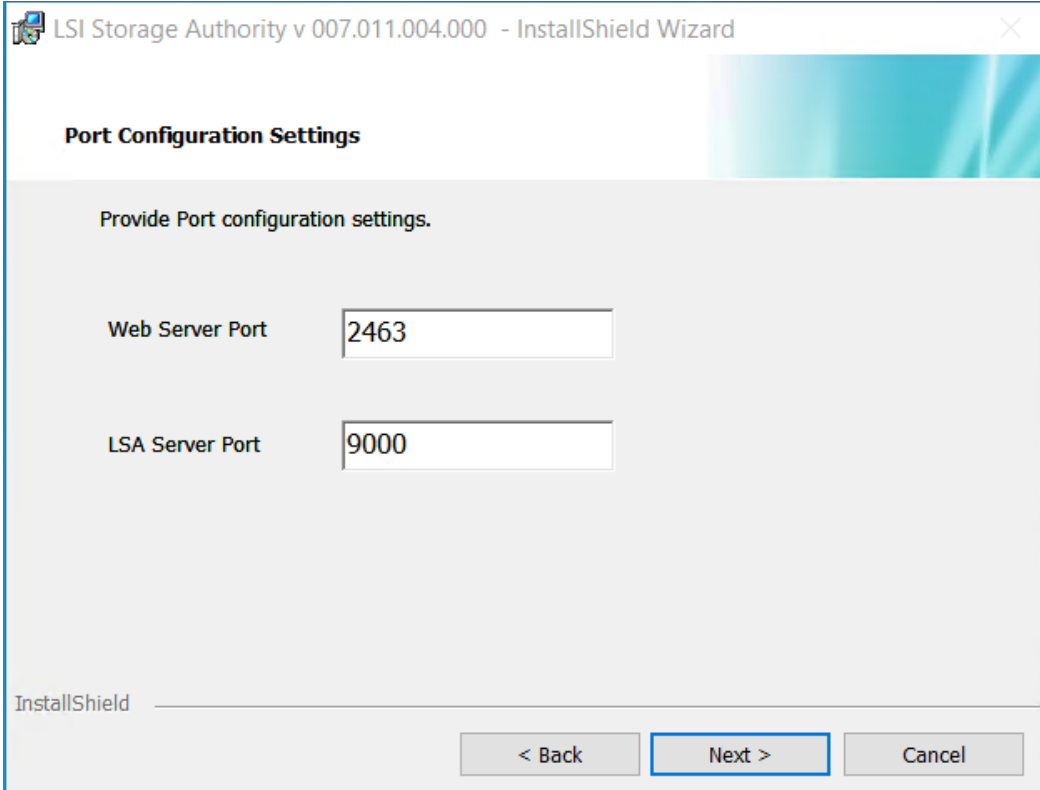
Figure 2: Port Configuration Settings Dialog

LSI Storage Authority v 007.011.004.000 - InstallShield Wizard

Port Configuration Settings

Provide Port configuration settings.

Web Server Port

LSA Server Port

InstallShield

< Back Next > Cancel

By default, LSA communicates on **Web Server Port 2463** and **LSA Server Port 9000**. Ensure that these ports are available to be used by LSA. Depending on your environment, if these ports are not available, specify the port details here. You can also edit this port's details after installation. See [Changing the LSI Storage Authority Application Port Number](#) and [Changing the nginx Web Server Port Numbers](#).

5. Click **Next** to proceed.

The **Destination Folder** dialog appears with the default file path.

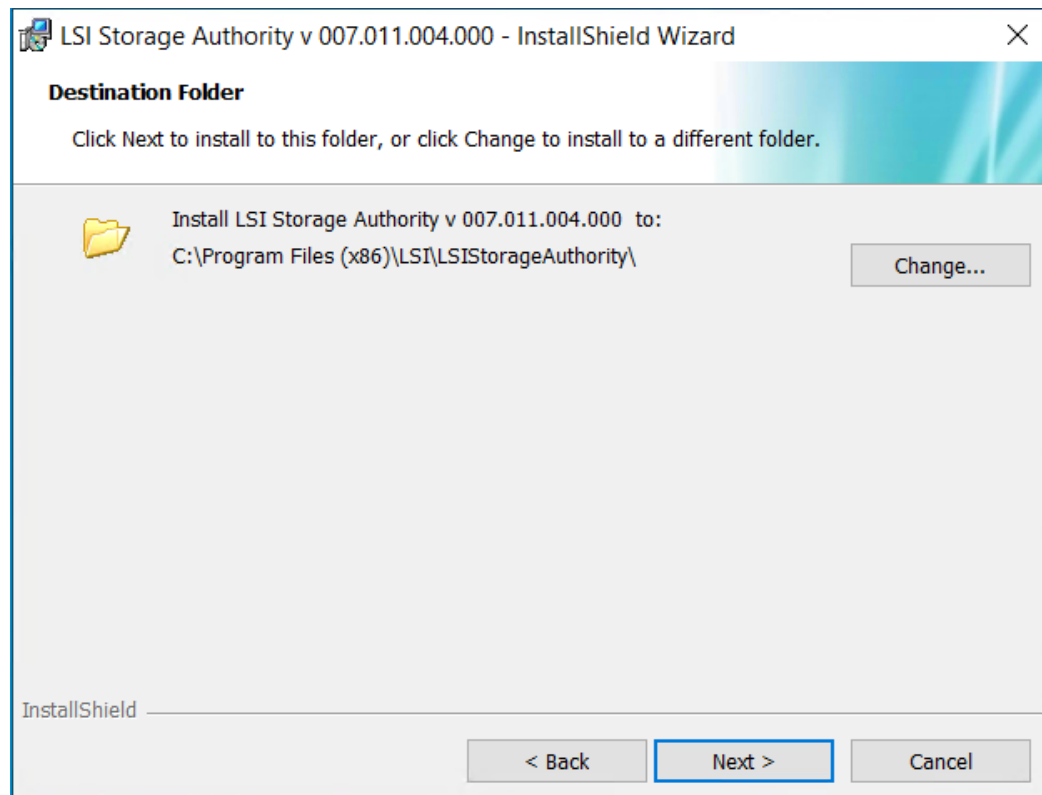
Figure 3: Destination Folder Dialog

6. (Optional) Click **Change** to select a different destination folder for the installation files.
7. Click **Next**.

The **Configure Range of Events to Generate Alert Notifications** dialog appears. You can configure alert notifications to get early notification of application or service issues and problem occurrences.

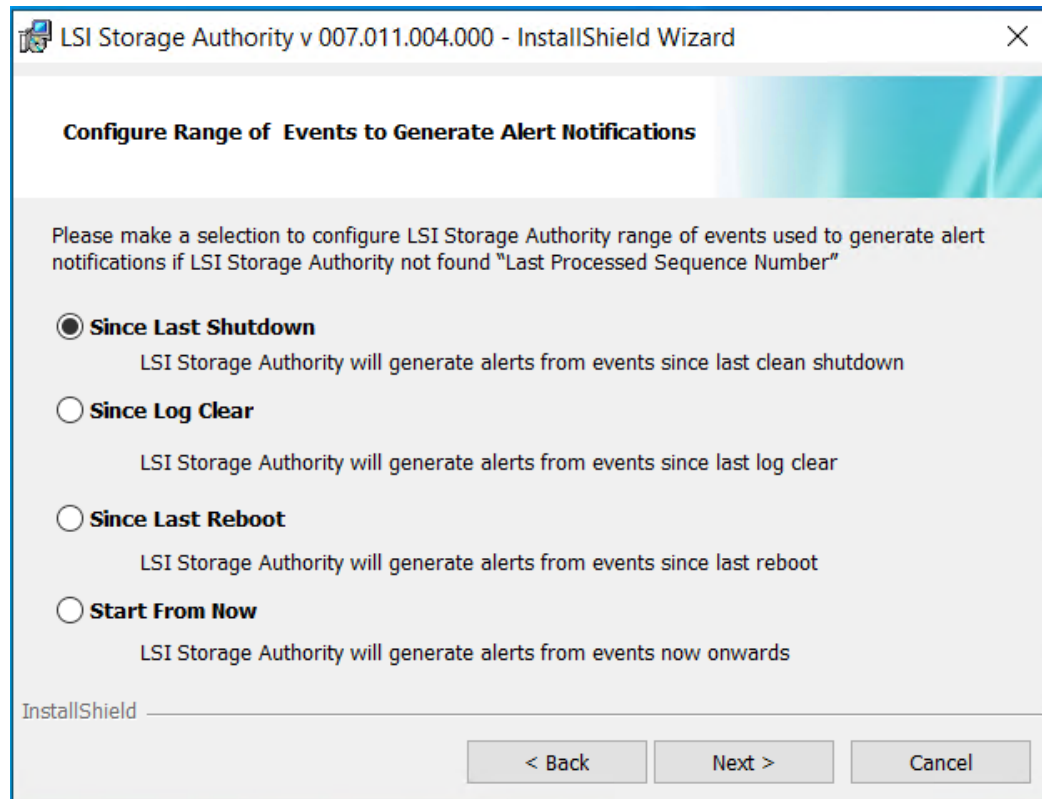
Figure 4: Configure Range of Events to Generate Alert Notifications

The following configuration options are available:

- **Since Last Shutdown:** Select this option to retrieve events from the last clean shutdown. By default, you can only retrieve the last 30 events. If there are any progress events as part of the last 30 events, those progress events will not be part of the event history. If the sequence numbers are less than the last log that was cleared (**Since Log Clear** option), LSA always retrieves events from the *Since Log Clear* option.
- **Since Log Clear:** Select this option to retrieve events from the last log that was cleared. By default, you can only retrieve the last 30 events. If there are any progress events as part of the last 30 events, those progress events will not be part of the event history.
- **Since Last Reboot:** Select this option to retrieve events from the last time the system was restarted. By default, you can only retrieve the last 30 events. If there are any progress events as part of the last 30 events, those progress events will not be part of the event history. If the sequence numbers are less than the last log that was cleared (**Since Log Clear** option), LSA always retrieves events from the *Since Log Clear* option.
- **Start From Now:** Select this option to retrieve events from now.

You can also change these configuration options as per your requirement at any point in time by editing the `lsa.conf` file in the `LSI Storage Authority/conf` directory and choosing the required parameter. For example, if you have selected **Since Last Shutdown** as a configuration option to retrieve events during the time of installation and you want to change it to **Since Last Reboot**, through the `lsa.conf` file, go to `# Retrieve range of events used to generate alert notification, if LSA not found LastProcessedSeqNum` section in the `lsa.conf` file, change the `retrieve_range_of_events_since = to 2` (`retrieve_range_of_events_since = 2`).

NOTE

You must restart the LSI Storage Authority service for the configuration changes to take effect.

8. Click **Next**.

The **Setup Type** dialog appears.

Figure 5: Setup Type Dialog

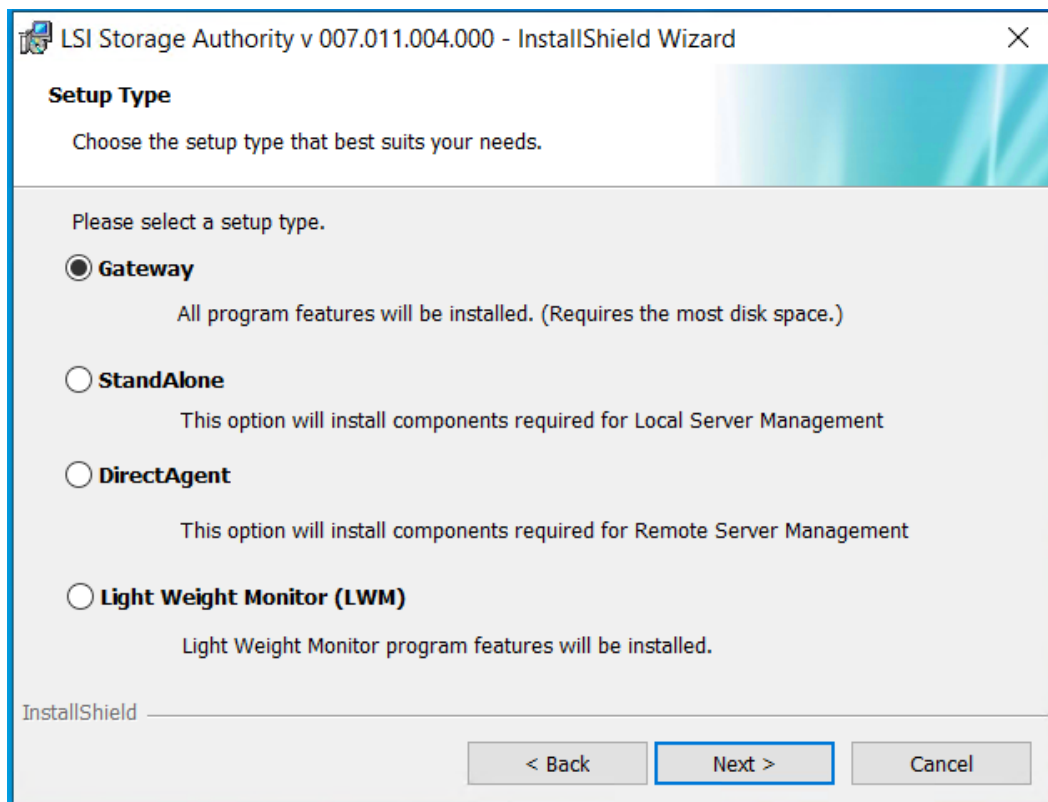

9. Select a setup type that suits your needs. The following options are available:

For more information on each of these installers and their associated advantages, see [Table 1](#), .

- **Gateway**
- **StandAlone**
- **DirectAgent**
- **Light Weight Monitor (LWM)**

10. Click **Next**. The **Ready to Install the Program** windows appears. Click **Next**.

Depending on the setup type you have selected, the **InstallShield Wizard Completed** dialog appears.

11. (Optional) Select the **Show the Windows Installer log** check box to view the windows installer log file.

The log file (`LSA_install.log`) is created in the same folder from where the `setup.exe` is installed.

12. Ensure that port 2463 is not blocked by a firewall.

The Windows Firewall settings are located under **Control Panel > Windows Firewall**.

13. Click **Finish**.

Installing in Noninteractive Mode

You must log in to the system with root privileges. You can also open the command prompt as root and run the installer through the command line.

Perform the following steps to install the LSI Storage Authority software in noninteractive mode:

1. From the command line, run the `vc_redist_x86.exe /Q` command to install the *Microsoft Visual C++ 2008 Redistributable Package for x86* if it is not already installed.

The Microsoft Visual C++ 2008 Redistributable Package for x86 (`vc_redist_x86.exe`) is available under the directory `<Package_Dir>\ISSetupPrerequisites\{270b0954-35ca-4324-bbc6-ba5db9072dad}\VC Redist 2008 Installation`.

OpenSLP is bundled with LSA 2.2 and later. While installing LSA, if OpenSLP is not installed ensure that you select the option to install OpenSLP, and LSA seamlessly installs the required version of OpenSLP. See [OpenSLP](#) for more information.

2. Depending on the type of installation required, run the `setup.exe /s /v/qn ADDLOCAL=` command. The types of installation and their associated alert notifications available are as follows:

Type of Installation	Type of Event Notification	Event Notification Choice
Gateway	Since Last Shutdown	0
StandAlone	Since Log Clear	1
DirectAgent	Since Last Reboot	2
Light Weight Monitor	Start From Now	3

Example: If you require the Light Weight Monitor to be installed, you must run the `setup.exe /s /v/qn ADDLOCAL=LightWeightMonitor INSTALLATIONCHOICES=129 INSTALLDIR=CustomDirecotryLocation` command.

Uninstalling in Interactive Mode

Uninstall the LSI Storage Authority software through the Control Panel using the following procedure.

1. Select **Control Panel > Programs and Features**.
2. Select the LSI Storage Authority software from the list, and click **Uninstall**.

Uninstalling in Noninteractive Mode

You must log in to the system with root privileges. You can also open the command prompt as root and run the installer through the command line.

Perform the following step to uninstall the LSI Storage Authority software in noninteractive mode:

From the command line, run the `msiexec.exe /x <productcode>/qn` command to uninstall LSA.

Where `<productcode>` is a unique product code that is associated with each LSA installation and `<LSA_HOME_PATH>` is the location where the LSA is installed.

Example: `msiexec.exe /x {20660CCB-7C70-4D61-8D18-FB7FA3C476C9}/qn`

IMPORTANT

In Windows operating systems, the `LSA_HOME` directory is accessible only by administrators.

Before you begin to uninstall LSA, if any files have been manually copied to the `<LSA_HOME>` directory by you other than the standard installation package contents, make sure you delete those files. If you fail to remove the files that have been manually copied to the `<LSA_HOME>` directory, the uninstallation process may fail.

Installing the LSI Storage Authority Software on the Linux Operating System

This section provides the information for installing LSI Storage Authority Software on the Linux operating system.

The LSI Storage Authority software supports both the interactive and the noninteractive modes of Linux installation.

Installing in the Interactive Mode

You must log in to the system with root privileges. You can also open the command prompt as root and run the installer through the command line.

Perform the following steps to install the LSI Storage Authority software in the interactive mode.

1. Run the `./install.csh` command from the installation disk.
2. Read the license agreements for the software package. If you agree to the terms of the license agreements, press **Y**. Otherwise, press **N** to exit the installation.
3. The **Configure Range of Events to Generate Alert Notifications** dialog appears. You can configure alert notifications to get early notification of application or service issues/problem occurrences.

The following configuration options are available:

- **Since Last Shutdown:** Select this option to retrieve events from the last clean shutdown.
- **Since Log Clear:** Select this option to retrieve events from the last log that was cleared.
- **Since Last Reboot:** Select this option to retrieve events from the last time the system was restarted.
- **Start From Now:** Select this option to retrieve events from now.

You can also change these configuration options as per your requirement at any point in time by editing the `lsa.conf` file in the `LSI Storage Authority/conf` directory and choosing the required parameter. For example, if you have selected **Since Last Shutdown** as a configuration option to retrieve events during the time of installation and you want to change it to **Since Last Reboot**, through the `lsa.conf` file, go to `# Retrieve range of events used to generate alert notification, if LSA not found LastProcessedSeqNum section in the lsa.conf file, change the retrieve_range_of_events_since = to 2 (retrieve_range_of_events_since = 2)`. You must restart the LSI Storage Authority service for the configuration changes to take effect.

4. Select a setup type that suits your needs. The following options are available:
 - **Gateway** – Press **1**. Selecting this option installs all the program features.
 - **StandAlone** – Press **2**. Selecting this option installs components that are required for Local Server Management.
 - **DirectAgent** – Press **3**. Selecting this option installs components that are required for Remote Server Management.
 - **Light Weight Monitor** – Press **4**. Selecting this option installs the Light Weight Monitor program features.
5. Enter the nginx server port number. The port range is from 1 to 65535. The default port number is 2463.
6. Enter the LSI Storage Authority application port numbers. The port range is from 1 to 65535. The default port number is 9000.

Ensure that the `nginx_port` number and the `LSA_port` number are between 1 and 65535 and are different. If the `nginx_port` number and the `LSA_port` number are not specified in the command line, the default values are used.

By default, LSA communicates on Web Server Port 2463 and LSA Server Port 9000. Ensure that these ports are available to be used by LSA. Depending on your environment, if these ports are not available, specify the port details here. You can also edit this port details after installation.

7. Ensure that port 2463 is not blocked by a firewall.
8. Extract the contents of the zip file and install the 64-bit Linux operating systems. The `LSA_Linux.zip` file contains files for 64-bit platforms.

NOTE

LSA only supports 64-bit operating systems.

NOTE

Ensure that **Connect automatically** check box is selected, which is available under **Network Connections**.

9. To launch the LSI Storage Authority, navigate to your browser and enter your IP Address followed by:2463. For example, `http://135.24.237.36:2463`.

Installing in the Noninteractive Mode

You must log in to the system with root privileges. You can also open the command prompt as root and run the installer through the command line.

1. Run the `./install.csh [-options] [nginx_port] [LSA_port]` command from the installation disk.

Where:

- `options`: `c` for complete setup and `m` for monitor setup.
- `nginx_port`: The nginx server port number.
- `LSA_port`: The LSI Storage Authority application port numbers.

Ensure that the `nginx_port` number and the `LSA_port` number are in the between the range, 1– 65535 and are different. If the `nginx_port` number and the `LSA_port` number are not specified in the command line, the default values (nginx default port 2463 and LSA default) are used.

Command usage examples:

- Gateway installation with default ports: `./install.csh -g`
- StandAlone installation with default ports: `./install.csh -s`
- DirectAgent installation with default ports: `./install.csh -d`
- Light Weight Monitor installation with default ports: `./install.csh -l`
- Gateway installation with different ports: `./install.csh -g 1234 8000`
- StandAlone installation with different ports: `./install.csh -s 4321 7000`
- DirectAgent installation with different ports: `./install.csh -d 1254 8800`
- Light Weight Monitor installation with different ports: `./install.csh -l 4388 9900`

2. Extract the contents of the zip file and install the 64-bit Linux operating systems. The `LSA_Linux.zip` file contains the files for the 64-bit platform.

Uninstalling the LSI Storage Authority Software on the Linux Operating System

Perform the following step to uninstall the Linux operating system.

Run the `uninstaller.sh` script (`/opt/lsi/LSIStorageAuhority/uninstaller.sh`). Alternatively, you can run the `rpm -e <rpm_name>` command to uninstall the RPMs from the target system.

Command usage example: `rpm -e LSIStorageAuhority-1.00xx.xxxx-xxxx`

Adding a Digital Signature and Enabling ASLR and DEP for LSI Utilities

The LSI Storage Authority software supports both address space layout randomization (ASLR) and data execution prevention (DEP).

Adding a Digital Signature in a Windows Environment

To add a digital signature in a Windows environment:

1. Ensure that the `Setup.exe` has been signed.
2. If necessary, install the signed certificate.
The signed certificate will not be installed during the installation.
3. Run the `signtool.exe verify /v /pa <LSA executable name>` command to complete the signature verification.

NOTE

The `signtool.exe` is required to validate the signature.

Adding a Digital Signature in a Linux Environment

To add a digital signature in a 64-bit environment:

1. Ensure that only the LSA RPM has been signed.
During the installation of LSA, the signed certificate is imported into the servers.
The certificate will not be removed during the uninstallation or upgrade of LSA.
2. Verify the LSA RPM signature.
 - a) Import the public key to RPM DB using the following command: `rpm --import pubKey.asc`.
 - b) Verify the RPM signature using the following command: `rpm -Kv<LSIStorageAuthority-xxx.xxx.xxx.xxx.rpm>`.
3. Upon successful installation, the following message is displayed:

```
md5 gpg OK
```

Managing Light Weight Agent

The section provides information on managing the Broadcom Light Weight Agent (LWA) software.

Previously, LSA support for VMware ESXi 6.x was achieved using an SMI-S provider. The LWA software provides server monitoring and management capabilities. LWA is a stand-alone installation on an ESXi server without SLP or LDAP support. LWA has a smaller footprint and provides the same set of features as the StandAlone installation.

See [Light Weight Agent Installer](#) for information on features and limitations.

Installing LWA on VMware ESXi

To deploy the Light Weight Agent (LWA) on a VMware ESXi machine, use the VIB file that is provided by Broadcom. LWA can be installed on VMware ESXi 7.x or 8.x.

Depending on the operating system you are using, complete one of the following procedures to install LWA.

- ESXi 7.x — [Installing LWA on VMware ESXi 7.x](#)
- ESXi 8.x — [Installing LWA on VMware ESXi 8.x](#)

Installing LWA on VMware ESXi 7.x

To deploy the Light Weight Agent (LWA) on a VMware ESXi 7.x machine, use the VIB file that is provided by Broadcom.

1. Log in to the system as root or as a user with root privileges.
Depending on the operating system and security settings, it may be necessary to install LSA using root rights.
 - Log in as root and run the installer.
 - Open a command prompt as root, and run the installer through the command line.
2. Download the `BCM_bootbank_BCM-vmware-lsa_ xxxx-xxxx-xx.vib (x86_64 arch only)` file.
3. Copy the `BCM_bootbank_BCM-vmware-lsa_ xxxx-xxxx-xx.vib` file to the host VMware ESXi 7.x machine.
4. Run the following `esxcli` command to install the VIB.

```
esxcli software vib install --viburl=/vmfs/volumes/datastore1/BCM_bootbank_BCM-vmware-  
lsa_XXXXXXXX-0x.vib
```

This step installs LSA to the `/opt/lsa` directory and starts the service.

5. Manage the service using `/etc/init.d/lsad {start|stop|restart}`.
LSA is now running along with the `lighttpd` server.

NOTE

On every reboot the firewall is enabled, so ensure that port 2463 is not blocked by a firewall.

Installing LWA on VMware ESXi 8.x

To deploy the Light Weight Agent (LWA) on a VMware ESXi 8.x machine, use the component or VIB file that is provided by Broadcom.

1. Log in to the system as root or as a user with root privileges.
Depending on the operating system and security settings, it may be necessary to install LSA using root rights.
 - Log in as root and run the installer.
 - Open a command prompt as root, and run the installer through the command line.

2. Complete the VIB installation.

- a) Download the `BCM_bootbank_lwmd_XXXXXXXX-0x.vib` (x86_64 arch only) file.
- b) Copy the `BCM_bootbank_lwmd_XXXXXXXX-0x.vib` file to the host VMware ESXi 8.x machine.
- c) Run the following `esxcli` command to install the VIB.

```
esxcli software vib install --viburl=/vmfs/volumes/datastore1/BCM_bootbank_BCM-vmware-
lsa_XXXXXXXX-0x.vib
```

This step installs LSA to the `/opt/lwmd` directory and starts the service.

- d) When prompted, reboot the system.
- e) Manage the service using the `esxcli` command.

For example, `esxcli daemon control {start|stop|restart} -s lwmd`

LSA is now running along with the `lighttpd` server.

3. Complete the component installation.

- a) Download the `vmware-lsa-00x.xxx.xxx.xxx-0x.zip` (x86_64 arch only) file.
- b) Copy the `vmware-lsa-00x.xxx.xxx.xxx-0x.zip` file to the host VMware ESXi 8.x machine.
- c) Run the following `esxcli` command to install the component.

```
esxcli software component apply -d /vmfs/volumes/datastore1/ vmware-
lsa-00x.xxx.xxx.xxx-0x.zip
```

This step installs LSA to the `/opt/lwmd` directory and starts the service.

4. When prompted, reboot the system.

NOTE

In ESXi 8, LWA is running on port 35557 and the LWA VIB is packaged with the required firewall ruleset. By default, the firewall rules are disabled and you can change the firewall using the `esxcli` command.

5. Manage the service using the `esxcli daemon control {start|stop|restart}` command.

LSA is now running along with the `lighttpd` server.

NOTE

In an unsigned environment, use the `--no-sig-check` argument during the installation.

Uninstalling LWA from VMware ESXi

Depending on your VMware version, run one of the following commands to uninstall LWA.

- **ESXi 7.x**—`esxcli software vib remove -n <name of LSA package>`
The LSA package name is derived using the following command.

```
esxcli software vib list |grep -i LSA
```
- **ESXi 8.x**—`esxcli software vib remove -n lwmd`
The LSA package name is derived using the following command.

```
esxcli software vib list |grep -i BCM
```

Managing LSA and Web Services on VMware ESXi 7.x

Use the following commands to manage LSA and Web Service using LWA.

- To start LSA and lighttdp, run: `/etc/init.d/lsad start`
- To stop LSA and lighttdp, run: `/etc/init.d/lsad stop`
- To restart LSA and lighttdp, run: `/etc/init.d/lsad restart`
- To shut down LSA, run: `/etc/shutdown.d/lsad`
- To check status of LSA and lighttdp, run: `/etc/init.d/lsad status`

Managing LSA and Web Services on VMware ESXi 8.x

Use the following commands to manage LSA and Web Service using LWA.

- To start LSA and lighttdp, run `esxcli daemon control start -s lwmd`
- To stop LSA and lighttdp, run `esxcli daemon control stop -s lwmd`
- To restart LSA and lighttdp, run `esxcli daemon control restart -s lwmd`
- To check status of LSA and lighttdp, run `esxcli daemon info get -s lwmd`

Managing LSA on VMware ESXi Operating Systems

This section outlines the preinstallation and postinstallation requirements that are essential to run and manage LSA on the VMware ESXi operating systems.

Beginning with VMware ESXi 7.x and up, VMware ESXi can be managed by installing LWA directly.

NOTE

LSA cannot be installed directly on the VMware ESXi operating system for versions before ESXi 7.x. LSA installed on VMware ESXi 7.x and below is managed through the LSA client that is installed on a Linux or Windows machine in the same subnet.

1. Provider Services

Ensure that the Provider Services are up and running before performing the VMware ESXi Discovery from the LSA client (Windows and Linux).

Execute the following commands to make sure that the Provider services are up and running on VMware ESXi:

```
/etc/init.d/slpd status
/etc/init.d/sfcbd-watchdog status
```

2. Configuration Change Details

If there is any configuration change, ensure that you perform the following actions:

```
- /etc/init.d/sfcb-watchdog stop
- /etc/init.d/slpd stop
- /etc/init.d/slpd start
- /etc/init.d/sfcb-watchdog start
```

3. Storage Controller

Ensure that the storage controller on VMware ESXi has the right configuration (firmware and driver) and the storage controller is working as expected before connecting through LSA. The following command helps you verify whether the controller is getting detected:

```
enum_instances cim_system lsi/lsimr13
```

4. Network Communication Details

Network communication is a key element for a proper communication between the VMware ESXi CIM provider and the Broadcom management software. Make sure that the network settings are correct by making the following changes:

- Provide a proper host name and an IP address while performing the initial configurations for the VMware ESXi host. See [How to Configure Networking on VMware ESXi?](#) for more information.
- For networks that do not have DNS configured, the “hosts” file on the system on which LSA is installed must be edited as follows:
 - a. Add an entry to map the VMware host’s IP address with the host name, so that the discovery process happens correctly. In the absence of this entry, the VMware host would be discovered as `0.0.0.0`.
 - b. Add an entry to map the actual IP address of the localhost with its host name (an entry for the loopback address would be present by default in the hosts file and it should not be removed to ensure that the Asynchronous Event Notifications [AENs] are delivered correctly). For example, if `135.24.228.136` is the IP address of your VMware host and `135.24.228.137` is the IP address of your Linux host, the following entries must be added in the `hosts` file:

```
135.24.228.136 dhcp-135-24-228-136.lsi.com dhcp-135-24-228-136 #VMware
135.24.228.137 dhcp-135-24-228-137.lsi.com dhcp-135-24-228-137 #Linux
```

NOTE

Ensure that port 2463 is not blocked by a firewall.

Remote management of VMware ESXi is supported only in a Gateway installation of LSA on the following operating systems:

- Microsoft Windows Server
- RHEL
- SUSE Linux

Windows and Linux Steps

The following steps are required to be performed on the Windows/Linux client:

NOTE

Both the client and the server should be in the same subnet.

1. Ensure that port 2463 is not blocked by a firewall.
2. Install the latest LSA client in a Gateway installation mode.
3. Launch LSA.
4. Ensure that the LSA Service is up and running.
5. Ensure that other LSA servers in the network are being discovered.
6. Ensure that VMware IP is being discovered as part of the **Remote Server Discovery** page.
7. Log in with your VMware credentials to monitor and manage the storage controller through the LSA client.

Configuring the Network on VMware ESXi Environment

- By default, during the VMware ESXi operating system installation the IP and host name should be configured appropriately.
- If an already installed VMware ESXi operating system is moved from one network to the other, and if the host name mapping is not correct, follow the steps that are mentioned in the following link to configure the network and host name:

[How to Configure Networking on VMware ESXi?](#)

Multi-subnet Configuration

- CURL error in CIMOM server results in a blocked AEN to the upper layer (CIMProvider-->LSA). This error happens if the servers are in different subnets or if there are any incorrect or incomplete AEN subscriptions. To avoid this error, you must have both the client and the server in the same subnet. Any incomplete AEN subscriptions must be removed using the CIMClient.

To view the existing subscriptions, enter:

```
host-ind -s
```

To remove an existing subscription, enter:

```
host-ind -d -k <handler name>
```

For example, `host-ind -d -k dhcp-x.y.z.k.dhcp.company.net_LSA_127.0.0.1`

If the previous command failed in the latest versions of VMware ESXi, use the command `indcfg`.

- `indcfg -l` – Views the existing subscriptions.
- `indcfg -c` – Clears the subscriptions.

Restart or reboot the `sfc` service after any change in the VMware server.

- To restart the server use:

```
esxcli system wbem set -e 0
esxcli system wbem set -e 1
```

You should either restart the `sfc` service or reboot the VMware server after making any changes.

Managing Host Hardware RAID Controllers

The Host Hardware RAID Controller (HHRC) defines the model and functions of a host where a RAID Controller resides.

Increasing the Memory Limit of the Host Hardware RAID Controller

To increase the memory limit of the Host Hardware RAID Controller (HHRC), perform the following steps:

1. Edit the `/etc/sfcb/sfcb.cfg` file.
2. Insert `provMemOverride: hhrc=100` into the file.
3. After making the required changes, restart the VMware server.
4. Verify that the changes that you made have taken effect by running the following command:

```
memstats -r group-stats -u mb -s name:min:max:memsize:memsizepeak | grep -E "hhrc|memSizePeak|--"
```

Increasing the Polling Interval of the Host Hardware RAID Controller

To increase the polling interval of the HHRC, perform the following steps:

1. Connect to the **vCenter Server** using the **vSphere Web Client**.
2. Select an ESXi host in the inventory.
3. Click the **Manage** tab.
4. Click the **Settings** sub-tab.
5. Click **Advanced System Settings** under **Systems**.

Settings are listed alphabetically by name similar to *SectionName.OptionName*.

6. Click the **Filter box** to search for an appropriate setting name.
7. Select the setting by name from the list. The options are:
 - `UserVars.CIMvmw_hhrcwrapperProviderPollingInterval`.
 - `UserVar/CIMvmw_hhrcwrapperProviderEnabled`.
8. Click the Edit (pencil) icon to modify the following values.
 - a) Change the value in `UserVars.CIMvmw_hhrcwrapperProviderPollingInterval` to 3600.
 - b) Change the value in `UserVar/CIMvmw_hhrcwrapperProviderEnabled` to 0.
9. Click **OK** to accept the changes.

Disabling the Host Hardware RAID Controller

To disable HHRC, enter the following commands in order:

1.

```
# esxcli system settings advanced list | grep CIMvmw_hhrcwrapperProviderEnabled  
[returns]  
Path: /UserVars/CIMvmw_hhrcwrapperProviderEnabled
```

2. # esxcli system settings advanced set -o /UserVar/CIMvmw_hhrcwrapperProviderEnabled -i 0
3. # /etc/init.d/sfcbd-watchdog restart

Optimizing Event Notifications

On the LSA client, when you select multiple virtual drives to perform operations such as **Drive Initialization, Consistency Check, Drive Erase, Creating 240 Virtual Drives**, and so on, the VMware ESXi Server may time out. A time-out causes a delay in event notifications, which are currently received asynchronously.

To overcome this, you must configure the Provider and LSA to receive all event notifications in an optimal way.

For more information, see [Configuring the Provider on ESXi Servers](#) and [Configuring LSA on Gateway Servers for Optimizing Events](#).

NOTE

If you need event notifications or event refreshes to be displayed, ensure that only one IP address has been provided while configuring the Gateway Server on VMware ESXi platforms.

Configuring the Provider on ESXi Servers

Perform the following steps to configure the Provider on ESXi Servers to receive optimal event notifications:

1. Stop the Provider service by running the `/etc/init.d/sfcbd-watchdog stop` command.
2. Copy the `providerTraceLog.properties` file from `/etc/cim/lsi` directory to a temporary directory.
3. Modify the `providerTraceLog.properties` and add the following value:

```
LSA=true
```
4. Save the `providerTraceLog.properties` file.
5. Copy and replace the `providerTraceLog.properties` file from the temporary directory to `/etc/cim/lsi` directory.
6. Restart the Provider service by running the `/etc/init.d/sfcbd-watchdog start` command.

Configuring LSA on Gateway Servers for Optimizing Events

Perform the following steps to configure the LSA client on Gateway servers to receive optimal event notifications.

NOTE

The Gateway server and the accessing server should have the same LSA version.

1. Browse to the `LSA_HOME/Conf` directory and open the `LSA.conf` file.
2. In the `LSA.conf` file, search for `events_callback_at_once_vmware` field.
3. Set the value to 1 in the `events_callback_at_once_vmware` field.
If you want to disable event optimization, set this value to 0. By default, this value is set to 0.
4. Save and close the `LSA.conf` file.

NOTE

The CIM Provider changes are also required for this to be effective.

5. Restart the LSA Service.

Configuring LSA on Gateway Servers to Get Real-Time Events

Perform the following steps to configure the LSA client on Gateway Servers to get real-time events:

NOTE

The Gateway server and the accessing server should have the same LSA version.

1. Browse to the `LSA_HOME/Conf` directory and open the `LSA.conf` file.
2. In the `LSA.conf` file, search for the `event_grouping_time_gap` field.
3. Set the value to 0 in the `event_grouping_time_gap` field.
4. Save and close the `LSA.conf` file.
5. Restart the LSA Service.

Configuring the above settings to get real-time events will impact the performance of LSA.

Configuring the Firewall on Various LSA Installers

The following topics provide information on how to configure the firewall on various LSA installers on different operating systems:

- Gateway/StandAlone installer configuration on the Windows operating system.
- DirectAgent installer configuration on the VMware operating system.
- Gateway/StandAlone installer configuration on the Linux operating system.

NOTE

Ensure that port 2463 is not blocked by a firewall.

Configuring the Firewall on Gateway/StandAlone Installer (Windows)

You can configure the Gateway/StandAlone installer firewall on the Windows operating system.

A firewall profile is a way of grouping settings, such as firewall rules, connection security rules, and so on, that are applied to the system depending on where the system is connected.

The Windows operating system has three profiles, **Public**, **Private**, or **Domain**. You must enable one of these profiles appropriately based on your connection type.

After the firewall is enabled, inbound settings must have LSA as an exception. By default, inbound settings block all incoming connections unless specified as a rule or as an exception. You must add `nginx.exe \port number` as an exception.

Perform the following steps to add `nginx.exe \port number` as an exception:

1. Go to **Control Panel > Windows Firewall > Allow a program or feature through Windows Firewall**.
2. Select **Allow Another Program**.
3. Browse to the folder where LSI Storage Authority is installed.
4. From the `LSIStorageAuthority` installation folder, select **nginx.exe**.

Usually `nginx.exe` is installed under the `C:\Program Files\LSI\LSIStorageAuthority\server` location.

`nginx.exe` is the web server used by LSA as an interface with remote systems.

5. Click **Add** or select the check box to allow `nginx.exe` as an exception.
6. Click **OK**.

Alternatively, you can also create a new rule and set the profile type to unblock LSA from the firewall.

Configuring the Firewall on Gateway/StandAlone Installer (Linux)

You can configure the Gateway/StandAlone installer firewall on the Linux operating system. In most Linux systems, by default, all the inbound requests are accepted. You can also check the `iptables` entries to verify the configuration rules.

To verify to configuration rules set in any Linux system, execute the following command:

```
iptables -L
```

If the configuration rules are blocking access to LSA, run the following command to allow input connection to LSA:

```
iptables -I INPUT -p tcp --dport <webserver port> -j ACCEPT
```

For example, if your nginx port number is 2463 for LSA, you must run the `iptables -I INPUT -p tcp -dport 2463 -j ACCEPT` command.

Configuring the Firewall on InDirectAgent Installer

LSA uses the SMI-S Provider to discover and manage its storage controllers on the VMware environment. To discover the ESXi servers where SMI-S Providers are available, LSA uses the SLP as a discovery mechanism. CIMSLP advertises and allows remote systems to discover CIM servers. CIMHttpServer is a CIM server and is required to interact with the SMI-S Provider.

You can configure the DirectAgent installer firewall in the VMware environment.

To check whether the firewall is enabled, execute the following command:

```
esxcli network firewall get
```

If the firewall is enabled, CIMSLP services should be enabled in the rule set. To check whether CIMSLP services are enabled in the rule set, execute the following command:

```
esxcli network firewall ruleset list
```

If the rule ID of CIMSLP is set to false, CIMSLP is disabled, and LSA will be unable to discover the CIM service. To enable the CIM service, execute the following command:

```
esxcli network firewall ruleset set --enabled true --ruleset-id=CIMSLP
```

Similarly, CIMHttpServer should be enabled, so that it can interact with the SMI-S Provider.

Collecting Logs with InDirectAgent SMIS-Based Management

On successfully installing LSA, you can re-create the issue to collect the required log files for the VMware operating system.

Perform the following steps:

1. Stop the provider service by running the `/etc/init.d/sfcbd-watchdog stop` command.
2. Copy the `providerTraceLog.properties` file from `/etc/cim/lsi` directory to a temporary directory.
3. Modify the `providerTraceLog.properties`, and set the debug level by uncommenting the following line:
`#LEVEL=ERROR` to `"LEVEL=DEBUG`
4. Save the `providerTraceLog.properties` file.
5. Copy and replace the `providerTraceLog.properties` file from the temporary directory to the `/etc/cim/lsi` directory.
6. Restart the provider service by running the `/etc/init.d/sfcbd-watchdog start` command.
7. Re-create the issue.
8. Run the following command to collect the complete LSA logs:

```
vm-support
```

9. Share the location of the log file and where the log file was generated with the Technical Support Team.

Collecting Logs on Windows and Linux Operating Systems

On successfully installing LSA, you can re-create the issue to collect the required log files for Windows and Linux.

Perform the following steps:

1. Stop the `LSAService` .
2. Browse to the `LSA_HOME/Conf` directory and open the `LSA.conf` file.

IMPORTANT

In Windows operating systems, the `LSA_HOME` directory is accessible only by administrators.

3. In the `LSA.conf` file, search for the `log_level` field.
4. Modify the existing or default value in the `log_level` field to `64` .
5. In the `LSA.conf` file, search for the `log_cache_mode` field.
6. Modify the existing or default value in the `log_cache_mode` field to `0` .
7. Browse to the `LSA_HOME/logs` directory and delete the `logs.txt` file.
8. Restart the `LSAService` .
9. After you see the issue, share the `logs.txt` file from the `LSA_HOME/logs` directory.

Logout and Reboot Requirements on VMware Operating Systems

Some features and functionalities, such as flashing the firmware, personality management, profile management, managing SAS storage link speed, managing PCIe lane speed, and so on, may require server reboot for the changes to take effect.

or the previously mentioned functionalities, you must follow these instructions:

1. Log out from the LSA client.
2. Reboot the VMware server.
3. When the VMware server comes up, log in again to check whether the changes have taken effect.

NOTE

In cases where logout and reboot are required for certain functionalities as mentioned previously, you will be notified through message: `Please Logout and Re-login to the server once Reboot is complete` .

Behavior of Event History

LSI Storage Authority supports retrieving the list of previous events, also known as event history.

Figure 6: Behavior of Event History

The screenshot shows the 'Show Events' interface. At the top, there is a navigation bar with a back arrow and the text 'Go back to Drive Group, Drives and Other Hardware list', and a 'Close' button on the right. Below the navigation bar is a 'Show Events' header with a calendar icon. The main content area displays 'Displaying latest log entries' above a table of event log entries. To the right of the table is an 'Actions' menu with two options: 'Download Events' and 'Clear Events'.

Severity Level	Event ID	Locale	Description	Time, Date
Information	590	Physical Device	Power state change on PD 0x102(e0x11a/s1) from ON(0) to POWERSAVE(1)	1:15:23 AM,6 Oct'21
Information	590	Physical Device	Power state change on PD 0x101(e0x11a/s0) from ON(0) to POWERSAVE(1)	1:15:23 AM,6 Oct'21
Information	340	Physical Device	State change on PD 0x102(e0x11a/s1) from ONLINE(18) to UNCONFIGURED_GOOD(0)	12:44:33 AM,6 Oct'21
Information	340	Physical Device	State change on PD 0x101(e0x11a/s0) from ONLINE(18) to UNCONFIGURED_GOOD(0)	12:44:33 AM,6 Oct'21
Information	349	Virtual Drive Configuration	Deleted VD 0x1	12:44:33 AM,6 Oct'21
Information	287	Virtual Drive	Policy change on VD 0x1 to [ID=01 cp=00 dc=2] from [ID=01 cp=01 dc=2]	12:44:07 AM,6 Oct'21
Information	287	Virtual Drive	Policy change on VD 0x1 to [ID=01 cp=00 dc=2] from [ID=01 cp=01 dc=2]	12:44:07 AM,6 Oct'21
Information	498	Virtual Drive	VD 0x1 is available	12:44:06 AM,6 Oct'21
Information	348	Virtual Drive Configuration	Created VD 0x1	12:44:06 AM,6 Oct'21
Information	428	Virtual Drive	VD 0x1 is now OPTIMAL	12:44:06 AM,6 Oct'21
Information	340	Physical Device	State change on PD 0x102(e0x11a/s1) from UNCONFIGURED_GOOD(0) to ONLINE(18)	12:44:06 AM,6 Oct'21
Information	340	Physical Device	State change on PD 0x101(e0x11a/s0) from UNCONFIGURED_GOOD(0) to ONLINE(18)	12:44:06 AM,6 Oct'21
Information	340	Physical Device	State change on PD 0x104(e0x11a/s3) from HOT SPARE(2) to UNCONFIGURED_GOOD(0)	12:43:53 AM,6 Oct'21

LSA maintains the event history in three different log levels:

- 0 – Always read from firmware.
 - Firmware maintains a separate space to save event history, which can be retrieved using the `LSA.conf` file.
 - **MegaRAID Behavior** – The source of an event is firmware. All events are persisted in firmware and can be retrieved at any point in time.
 - **Non-MegaRAID Behavior** – The source of an event is Firmware, Driver, and StoreLib. Firmware generated events can only be persisted and can be retrieved.
- 1 – By default, persists only non-MegaRAID events in the log file.
 - Non-MegaRAID events include IR/HBA.
- 255 – Persists all events in the log file.
 - LSA monitors the log location of the individual controller under `$LSA_HOME/Conf/monitor/logs`.
 - The maximum number of events persisted in a file is 300. This can be configured through the `LSA.conf` file.
 - The maximum number of events that can be retrieved on a single page is 30. This can be configured through the `LSA.conf` file.
 - LSA maintains a set of events in the log file.
 - LSA starts maintaining the event history for Gateway, StandAlone, and DirectAgent installers from the time LSA is started.

Behavior of Event Monitoring

The following table details the behavior of event monitoring.

Table 6: Event Monitoring Behavior

Event	Description
SysLog	Immediately after the LSA service is started. This includes new installations as well as restart of LSA services.
Syslog location	On Windows: Event viewer. On Linux: <code>/var/log/messages</code>
Differentiating syslog	No special attribute is added as part of the event description.
LSA boot events	Boot events are handled for local controllers.
Time sync	Handled.
Alert configuration	Follows <code>config-current.json</code>
SMTP or SMTPS server communication	LSA server communicates with SMTP or SMTPS server for email communication.

Limitations of Installation and Configuration

The following are the limitations of this installation and configuration.

- No status information exists for the controller.
- Events are collected as long as LSA runs on the client.
- LSA on VMware responds slower as compared to the response of the LSA on the Windows or Linux operating systems.

Events are collected from the time the client logs in to a VMware ESXi machine for the first time. Events continue to be collected as long as the LSA service is running.

- When there are empty PD slots in an enclosure, PD operations and properties cannot be viewed.

IMPORTANT

All security-related browser settings must be set to the standard security settings. LSA is web-based application, and any browser setting changes impact LSA functionality.

Upgrading and Downgrading the Firmware on IT Controllers (VMware)

Due to some issues with VMware ESXi 6.7 and VMware ESXi 7.0 you cannot upgrade or downgrade IT firmware through LSA following the usual firmware flashing procedure. You must follow this procedure:

1. Edit the `/etc/sfcb/sfcb.cfg` file.
2. Add the `httpMaxContentLength: 4194304` parameter.
3. Restart the LSA service:
`/etc/init.d/sfcbd-watchdog restart`
4. Flash the firmware.

Differences in LSA for VMware ESXi

The following are some of the differences in LSA when you manage a VMware server.

- The following limitations apply to the system information exposed through the application:

- Only the host name appears.
- No support exists for the controller health information.
- **Authentication support:** The LSI Storage Authority Software allows CIMOM server authentication with the user ID and the password for VMware.
- **Event logging:** Event logging support is available for the VMware ESXi operating system, but it works differently than the normal LSI Storage Authority framework mode. The event logging feature for LSA client connected to a VMware ESXi system behaves as follows:
 - The system logs are logged in the remote server instead of logging in the VMware ESXi server.
 - The **View Log** option allows you to view the logs saved in a text file on the **Event Logger** dialog.
 - Refreshing the LSA GUI after any firmware update is slower for a client connected to VMware ESXi hosts, compared to one that is connected to a Windows or a Linux host.
- VMware ESXi is supported only on **Gateway** installation. StandAlone, DirectAgent, and Light Weight Monitor (LWM) installation modes are not supported.
- VMware ESXi is supported from the LSA Gateway installed on following operating systems:
 - Microsoft Windows
 - RHEL
 - SUSE Linux

Performing Initial Configuration

After successfully installing the LSI Storage Authority, you must set up these initial configurations.

- [Configuring LSA on LWA and LWM ESXi](#)
- [Domain Authentication Behavior](#)
- [Accessing LSA over Network Address Translation](#)
- [Changing the LSI Storage Authority Application Port Number](#)
- [Hiding an Empty Backplane](#)
- [Changing the nginx Web Server Port Numbers](#)
- [Changing the nginx Read Timeout](#)

Configuring LSA on LWA and LWM ESXi

Perform the following steps to configure the LSA client on LWA and LWM ESXi.

1. Based on your requirements, update any available parameters in the `/opt/lsi/LSIStorageAuthority/conf/LSA.conf` file.

- #client's maximum number of elements can be selectable at a time (32=default)
`clt_max_element_select_cnt = 32`
- #client's Server mode either 0 OR 1 (0=default)
`clt_server_mode = 0`
- #client's Schedule mode either 0 OR 1 (1=default)
`clt_schedule_mode = 1`
- #client's maximum response time for the vd element in milliseconds (4000=default)
`clt_max_resp_time_vd = 4000`
- #client's maximum response time for the pd element in milliseconds (8000=default)
`clt_max_resp_time_pd = 8000`

2. Restart the LSA Service.

Domain Authentication Behavior

The default installation of LSA contains entries in a properties file for administrators and authenticated users. The properties file contains two access groups for LSA.

- `full_access_groups` – Administrators and non-administrators
- `readonly_access_groups` – Authenticated users

LSA supports multiple comma (,) separated group names for both administrators and authenticated users. Users that are part of both groups are assigned administrative access to LSA. Server administrators can edit entries or add multiple groups to the individual entries.

Users who are part of the `full_access_groups` will have full access to LSA even if they are not an administrator. If the administrator group value is removed from the `full_access_groups`, an error message will display *Invalid Credentials*, and you will not be able to access LSA.

Users who are part of the `readonly_access_groups` will be given read-only access by default. If the authenticated users group value is removed from the `readonly_access_groups`, an error message will display *Invalid Credentials*, and you will not be able to access LSA even in read-only mode.

LSA will prompt users to provide the domain name, user name, and password of the server they are trying to access. Once the credentials are verified, users will be given access based on their assigned access level.

Adding Translated Names in Windows

Complete the following steps for non-English versions of Windows.

1. Stop the `LSAService`.
2. Browse to the `LSA_HOME/Conf` directory and open the `LSA.conf` file.

IMPORTANT

In Windows operating systems, the `LSA_HOME` directory is accessible only by administrators.

3. Add the translated names of the Administrators group to `full_access_groups` in the `LSA.conf` file.
This allows users to have full access privileges in the LSA after login.
4. Add the translated names of the Authenticated Users group to `readonly_access_groups` in the `LSA.conf` file.
This allows users to have read access privileges in the LSA after login.
5. Restart the `LSAService` and proceed to log in.

Adding Translated Names in Linux

Complete the following steps for non-English versions of Linux.

1. Stop the `LSAService` by using the `/etc/init.d/LsiSASH stop` command.
2. Navigate to `LSA_HOME/Conf` directory and open the `LSA.conf` file.
3. Add the translated names of the root group to the `full_access_groups` in the `LSA.conf` file.
This will allow users to have full access privileges in the LSA post login.
4. Add the translated names of the users group to the `readonly_access_groups` in the `LSA.conf` file.
This will allow users to have read access privileges in the LSA post login.
5. Restart the `LSAService` using the `/etc/init.d/LsiSASH start` command, and proceed with the login.

Using LDAP Authentication

To access the LDAP service, the LSI Storage Authority server must know some information about the LDAP server settings. Apart from the user name and password details for the LDAP authentication, the LSA backend must know some parameters to enable authentication. Perform the following steps to configure these parameters in the `lsa.conf` file in the `LSIStorageAuthority/conf` directory.

1. Open the `lsa.conf` file in the `LSIStorageAuthority/conf` directory.
2. Enter a value for the `ldap_mode` field. If you set it as `0`, the LDAP authentication using the LSI Storage Authority software is disabled. If you set it as `1`, the LDAP authentication using the LSI Storage Authority software is enabled.

Example:

```
LDAP Login
ldap_mode = 1
```

3. Enter the host name of the LDAP server in the `ldap_server` field. This value connects the specific LDAP server for the user authentication.

Example:

```
# LDAP Server
```

```
ldap_server = <IP Address of the LDAP server>
```

- (Optional) Enter the LDAP protocol version in the `ldap_protocol_version` field. This value defines the protocol to create an LDAP session.

Example:

```
# LDAP Protocol version
ldap_protocol_version = v3
```

The default value is `v3`.

- Enter the LDAP authentication mode in the `ldap_binding` field. In LDAP, the authentication is supplied through the Bind operation. LDAP supports three types of authentication modes:
 - Anonymous – When an LDAP session is created, that is, when an LDAP client connects to the server, the authentication state of the session is set to the anonymous mode.
 - BASIC (default) – The simplest form of client authentication is to bind to the server using a clear-text password. This mechanism has security problems because the password can be read from the network.
 - SECURE – A more secured method is to use an Simple Authentication and Security Layer (SASL) authentication mechanisms, such as DIGEST-MD5[4]. This method is based on an encryption known to both the client and the server, allowing for a simple challenge-response scheme. The SASL authentication mechanism is also capable of negotiating data encryption to protect subsequent operations.

Example:

```
# LDAP_BINDING
ldap_binding = BASIC
```

- (Optional) Enter the LDAP server port number in the `ldap_port_number` field.

Example:

```
# LDAP Port Number = 636
ldap_port_number = 389
```

- Enter the DN (distinguished name) details in the `dn_details` field. The format is as follows:

Example:

```
# LDAP_DN_DETAILS
dn_details={"DN":[{"key":"DC","values":["ldapdomain"]}, {"key":"DC","values":["com"]}, {"key":"ou","values":["TEST"]}]}
{"key":"ou","values":["TEST"]}]}
```

Where:

- DC – This attribute contains the Domain Component type.
 - ou – This attribute contains the name of an organizational unit.
- (Optional) Enter the LDAP user access privilege details in the `readOnly` field. The values follow:
 - 1 (default) – Read-only access.
 - 0 – Full access
 - Restart the nginx service and the LSI Storage Authority Service for the changes to take effect.

Accessing LSA over Network Address Translation

Network Address Translation (NAT) enables private IP networks that use unregistered IP addresses to connect to the Internet. NAT operates on a router, usually connecting two networks together, and translates the private addresses in the internal network into legal addresses.

To access the LSI Storage Authority application over a NAT environment, the LSA server must know some information about the NAT server settings.

Perform the following steps to configure the parameters in the `lsa.conf` file in the `conf` directory.

1. Open the `lsa.conf` file in the `LSIStorageAuthority/conf` directory.

2. Specify the public IP of `nat_ipv4_ipv6`.

For example, if the public NAT IP address configured is as `135.24.227.198`, you must specify `nat_ipv4_ipv6 = 135.24.227.198`.

3. Restart the `nginx` service and the LSA Service for the changes to take effect.

If you have multiple public NATs (for example, `135.24.227.198`, `135.24.227.199`, `fe80::dc8d:e156:41e1:b06`), you must specify them as `nat_ipv4_ipv6 = 135.24.227.198, 135.24.227.199, fe80::dc8d:e156:41e1:b06`

Changing the LSI Storage Authority Application Port Number

Perform the following steps to change the LSI Storage Authority Application port numbers.

1. Open the `lsa.conf` file in the `LSIStorageAuthority/conf` directory.

2. Enter the new port number in the `listening_port` field.

Prior to assigning the port number, ensure that the port is available for usage.

3. Save the `lsa.conf` file.

4. Open the `nginx.conf` file in the `LSIStorageAuthority/server/conf` directory.

5. Replace all of the `fastcgi_pass 127.0.0.1:9000` instances with `fastcgi_pass 127.0.0.1:<new port number>`.

6. Save the `nginx.conf` file.

7. Open the `portconfig.properties` file in the `LSIStorageAuthority` directory.

8. Enter the new port number in the `<Client Port> <new port number> </Client Port>` field.

9. Save the `portconfig.properties` file.

10. Restart the `nginx` service and the LSI Storage Authority Service.

Hiding an Empty Backplane

By default, LSA displays all the empty backplanes connected to the controller in the **Other Hardware** tab. However, if you must hide the empty backplanes from showing up in the **Other Hardware** tab, perform the following steps:

1. Stop the `LSAService`.

2. Open the `lsa.conf` file in the `LSIStorageAuthority/conf` directory.

3. In the `LSA.conf` file, search for `empty_SGPIO_display` field.

Modify the existing or default value in the `empty_SGPIO_display` field to 0.

- 0 – Disables the empty backplanes from showing up in the **Other Hardware** tab.
- 1 – Enables the empty backplanes from showing up in the **Other Hardware** tab.

By default, the `empty_SGPIO_display` field is set to 1.

4. Start the `LSAService` once again.

Changing the nginx Web Server Port Numbers

Perform the following steps to change the nginx web server port numbers.

1. Open the `nginx.conf` file in the `LSIStorageAuthority/server/conf` directory.
2. Replace all of the `listen 2463 default_server ssl` instances with `listen <new port> default_server ssl`.
3. Save the `nginx.conf` file.
4. Restart the nginx service and the LSI Storage Authority Service.

Changing the nginx Read Timeout

On VMware, when you request process-intensive operations such as creating **64 Virtual Drives, Drive Initialization, Consistency Check, Drive Erase**, and so on, the VMware ESXi Server may time out, resulting in a delay of the operation that is being performed.

To avoid the VMware ESXi Server timing out, perform the following steps to change the nginx FCGI Read Timeout.

1. Open the `nginx.conf` file in the `LSIStorageAuthority/server/conf` directory.
2. In the `nginx.conf` file, search for the `fastcgi_read_timeout` field.
3. Modify or increment the value present in the `fastcgi_read_timeout` to anywhere between 900 to 2000 depending on your requirement.
4. Save the `nginx.conf` file.
5. Restart the nginx service as well as the LSI Storage Authority Service.

Performing Initial Setup

After successfully logging into LSI Storage Authority, you must perform these initial setup tasks before proceeding.

- [Managing Servers from the Remote Server Discovery Page](#)
- [Adding Managed Servers](#)
- [Removing Managed Servers](#)
- [Manually Discovering Servers](#)
- [Alert Settings](#)
- [Setting Up the Email Server](#)
- [Adding Email Addresses of Recipients of Alert Notifications](#)

Managing Servers from the Remote Server Discovery Page

The LSI Storage Authority lets you set up a list of servers to monitor and manage. Perform the following steps to manage the servers:

1. On **Remote Server Discovery** page, click the **Go To – Manage Server Page** link.

The **Gateway – Authenticate** dialog opens.

Figure 7: Gateway – Authenticate Dialog

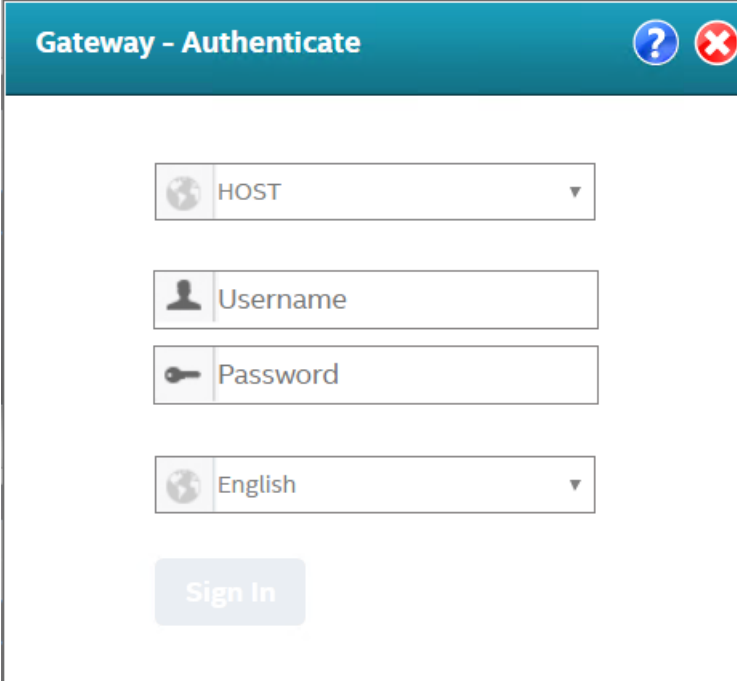

The screenshot shows a dialog box titled "Gateway - Authenticate". The dialog has a teal header bar with a question mark icon and a close icon. Below the header, there are four input fields: a dropdown menu with "HOST" selected, a text field with "Username", a text field with "Password", and a dropdown menu with "English" selected. At the bottom of the dialog is a "Sign In" button.

2. Enter the administrator credentials for the Gateway server.
 - a) Select either **DOMAIN** or **HOST** as the option from the drop-down list.
 - b) Specify the user name and the password in their respective fields.

The gateway server persists the login credentials in an encrypted file.

3. Click **Sign In**.

The **Remote Server Discovery** page switches to the **Manage Servers** page.

Figure 8: Remote Server Discovery Page

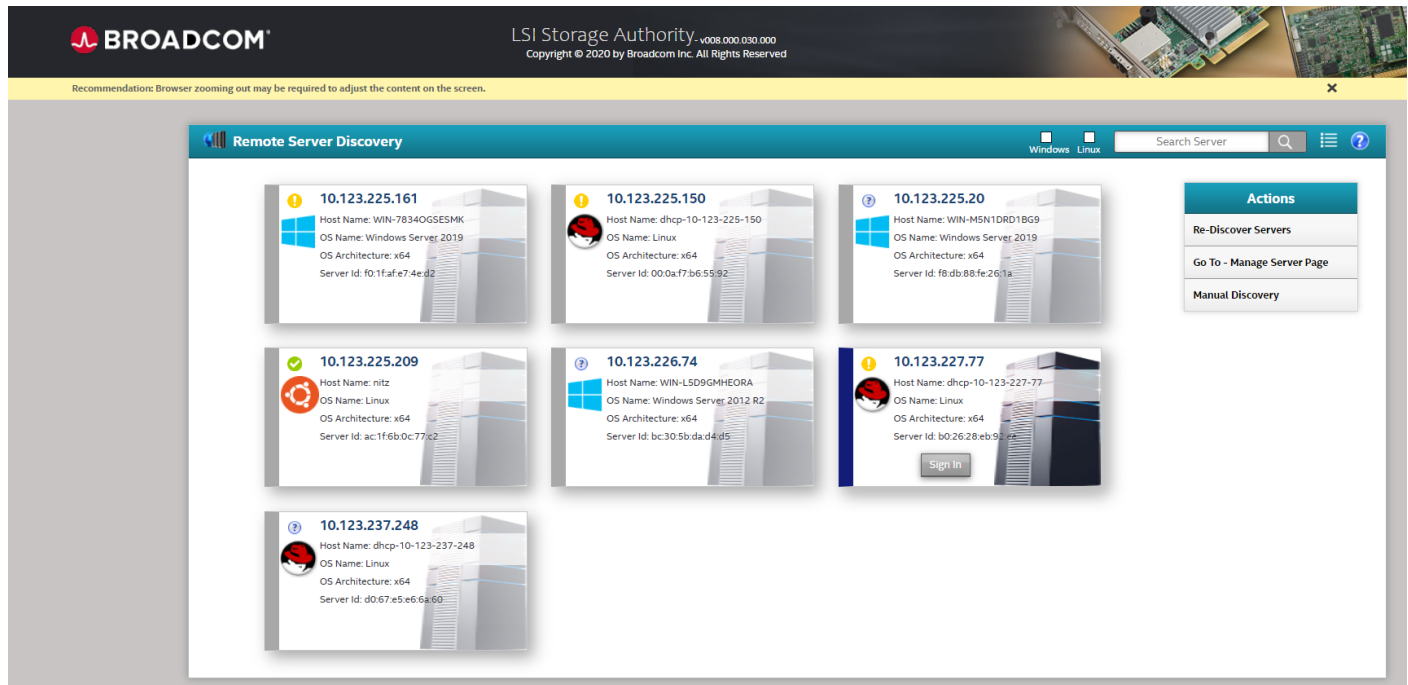

On the **Remote Server Discovery** or **Manage Servers** page, you can:

- View the list of managed servers with their health status.
- Add and remove the managed servers from the list.
For more information, see [Adding Managed Servers](#) and [Removing Managed Servers](#).
- Rediscover the servers or go back to the **Remote Server Discovery** page.
- Manually discover the servers using either the IP address or the host name.
See [Manually Discovering Servers](#).
- Use the check boxes of different operating system types to select only those servers that are associated with that particular operating system for display.
- Specify the IP address of the server in the search box to display that particular server.
- Toggle between **List** and **Grid** view by clicking the *List/Grid* icon.
By default, LSA displays all the servers in Grid view.

Adding Managed Servers

Perform the following steps from the **Manage Servers** page to add the managed servers.



1. Select a server that you want to add from the list of discovered servers, and click the  icon.
The **Remote – Authenticate** dialog appears.

Figure 9: Remote – Authenticate Dialog

The screenshot shows a dialog box titled "Remote - Authenticate". It features a teal header bar with a question mark icon and a red close button. Below the header, there are four input fields: a dropdown menu with "HOST" selected, a text field for "Username", a text field for "Password", and a dropdown menu with "English" selected. At the bottom center, there is a light blue "Sign In" button.

2. Enter the user credentials for the server you want to add.
 - a) Select either **DOMAIN** or **HOST** as the option from the drop-down list.
 - b) Specify the user name and the password in their respective fields.
3. Click **Sign In**.

The server is added to the list of managed servers. The  icon changes to the  icon.

4. Click the server that you have added to the managed server list.

The Server dashboard page for the server appears. See [Server Dashboard](#).

Once the administrator user logs into the Manage Server page, the local Gateway server will be added to the Manage Server list.



There is not an option to add the self server because the user is already logged in with full access.

Users will not see the Verify option for the self server or local gateway server because the details are not stored locally.

Removing Managed Servers

Perform the following step from the **Manage Servers** page to remove the managed servers.

Click the  icon.

The host is removed from the list of managed servers. The  icon changes to the  icon.

Manually Discovering Servers

LSI Storage Authority discovers servers that are in the same subnet automatically. However, using the **Manual Discovery** option that is available on the **Remote Server Discovery** page, you can manually discover the servers using either the IP address or the host name of the server. **Manual Discovery** option enables you to discover and manage servers that are outside the subnet.

Manual Discovery server health will not get updated unless the server is part of **Auto Discovered** list. If the **Manual Discovery** server is part of the **Auto Discovered** list, then the **Manual Discovery** server will be removed and will be displayed as Auto Discovered Server.

Adding the same server to **Manual Discovery** in different forms (different IP/Hostname) is not recommended. Adding a server with the same name will cause the same server to appear multiple times in the **Manual Server** or **Remote Discovery** pages.

Perform the following steps from the **Remote Server Discovery** page to manually discover servers that are outside the subnet.

1. On the **Remote Server Discovery** page, click **Manual Discovery**

The Manual Discovery dialog appears.

Figure 10: Manual Discovery Dialog

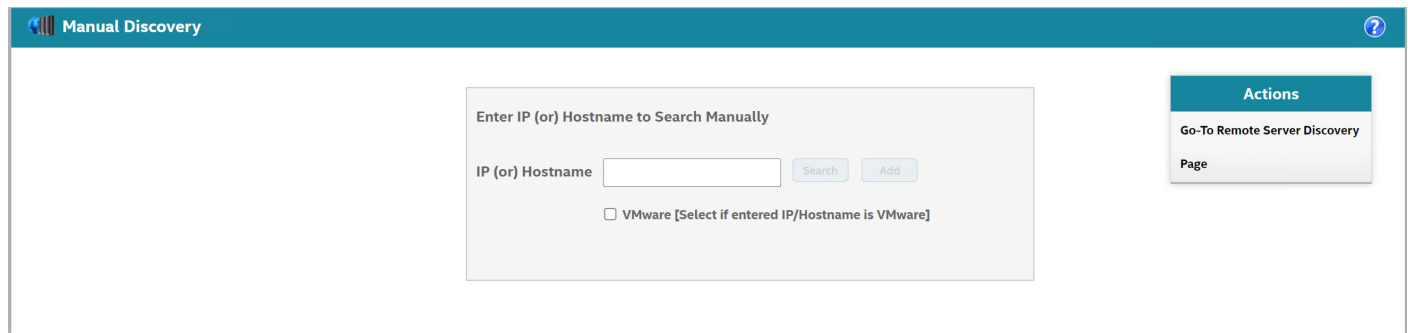

2. Specify either the IP address or the host name of the server that is outside the LSA subnet, which you wish to discover.
3. Click **Search**
Based on the IP address or the host name of the server specified by you, the corresponding server is displayed.
4. Click **Add** to add the newly discovered server to the list of Managed Servers.
 - a) (Optional) If you do not need this server to be listed in the Managed Servers list, click the **Remove Manually Added Server** icon to remove the server.
5. Click **Sign In** to login to the server
6. Specify the administrator credentials for the server and click **Sign In**.

The manually added server is now displayed or listed on the Remote Server Discovery page.

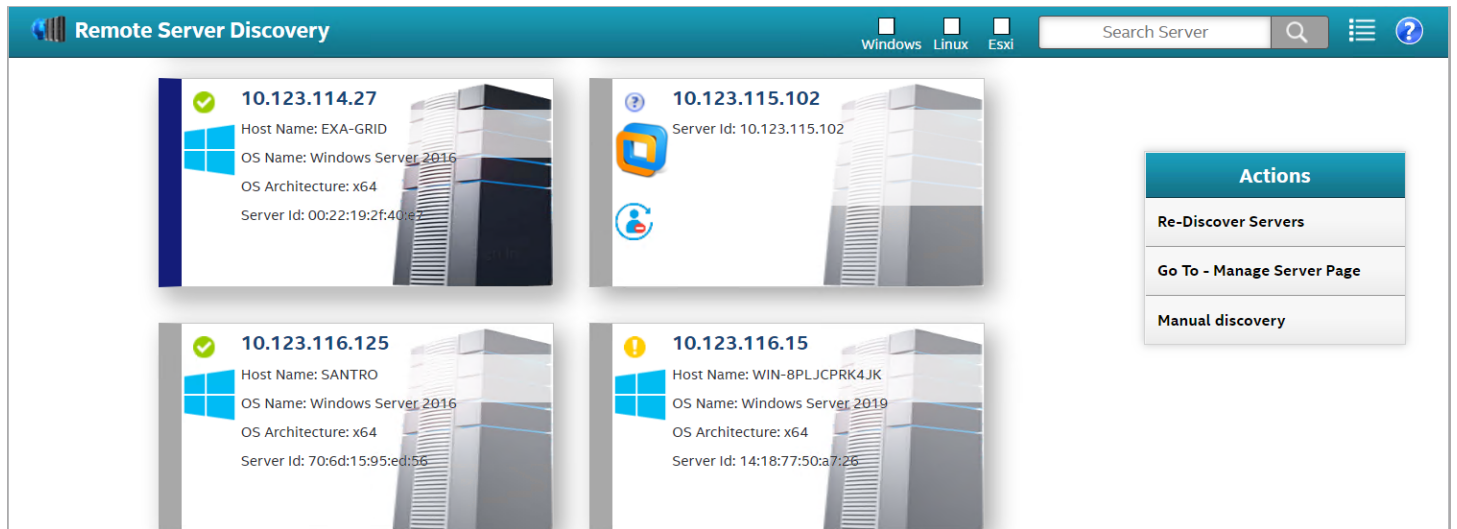
Figure 11: Remote Server Discovery – Manually Added Server

You can also choose to remove this server from the Remote Server Discovery list by clicking on the **Remove Manually Added Server** icon.

Alert Settings

The **Alert Settings** tab lets you perform the following actions:

- Change the alert delivery method for different severity levels.
- Specify different alert delivery methods for inside and outside the application.
- Revert back to the default alert delivery methods and the default severity level of an individual event.
- Save the alert settings on the server.

Based on the severity level (Information, Warning, Critical, and Fatal), the default alert delivery methods change. By default, each severity level has one or more alert delivery methods configured for it. The different alert delivery methods are as follows:

- **System Log** – By default, all of the severity events are logged in the local system log (syslog). In the Windows operating system, the system log is logged in **Event Viewer > Application**. In the Linux operating system, the system log is logged in `var/log/messages`.
- **Event Log** – By default, all the severity events appear in the event log. Click **View Event Log** to view the event log. Each message that appears in this log has a severity level that indicates the importance of the event (severity), an event ID, a brief description, and a date and timestamp (when it occurred).
- **System Messages** – By default, fatal and critical events are displayed as system messages. System messages are displayed in a yellow bar at the top of the Server dashboard and the Controller dashboard. System messages let you view multiple events in a single location.
- **Email** – By default, fatal events are displayed as email notifications. Based on your configuration, the email notifications are delivered to your inbox. In the email notification, besides the event's description, the email also contains system information and the controller's image details. Using this additional information, you can determine the system and the controller on which the fatal error occurred.

To change the alert delivery method for each severity level, perform these steps:

1. Select **Username > Settings > Actions** in the Server dashboard. The **Alert Delivery** window appears with the default alert delivery methods for each severity level.

Figure 12: Alert Delivery Window

Alert Delivery | Mail Server

Choose the alert delivery method for each severity level
Displaying Alert Settings

Fatal - when a component fails and data loss occurs			
Within Application	<input checked="" type="checkbox"/> System Log	<input checked="" type="checkbox"/> Event Log	<input checked="" type="checkbox"/> System Messages
Outside Application	<input checked="" type="checkbox"/> Email		
Critical - when a component fails			
Within Application	<input checked="" type="checkbox"/> System Log	<input checked="" type="checkbox"/> Event Log	<input checked="" type="checkbox"/> System Messages
Outside Application	<input type="checkbox"/> Email		
Needs Attention - when a component is close to Failure point			
Within Application	<input checked="" type="checkbox"/> System Log	<input checked="" type="checkbox"/> Event Log	<input type="checkbox"/> System Messages
Outside Application	<input type="checkbox"/> Email		
Information - informational message where no user action is necessary			
Within Application	<input checked="" type="checkbox"/> System Log	<input checked="" type="checkbox"/> Event Log	<input type="checkbox"/> System Messages
Outside Application	<input type="checkbox"/> Email		

Actions

- Save Settings
- Restore Default Settings

2. Select the desired alert delivery method for each severity level by selecting the required check box.
3. Click **Save Settings** to save the settings on the server.
Click **Restore Default Settings** to revert back to the default alert delivery settings.

NOTE

Restore Default Settings will not save the changes by default. To restore the default alert settings, click **Save Settings**.

Setting Up the Email Server

Perform the following steps to enter or edit the mail and the server settings.

1. In the **Settings** window, click the **Mail Server** tab.
The **Mail Server** tab appears and displays the current mail server settings.

Figure 13: Mail Server Window

2. Enter a sender's email address in the **Sender Email Address** field, or edit the existing sender email address.
3. Select the server type from the drop-down menu.
If the **Legacy** check box is selected, **SMTPs/SMTP** and **Secure with SSL/TLS** fields are not applicable.
4. Enter your server name/IP address in the server name field, or edit the existing details.
5. Clear the **Use Default** check box to enter the desired port number in the **Port** field.
6. If the server requires authentication, select the **This server requires authentication** check box and specify the authentication details in the **User Name** and **Password** fields.
7. Enter the email address that you want to add in the **Add Email Address** field.
8. Click **Add**.
The new email address appears in the **Email alerts will be sent to the following email ids** field.
9. Click **Yes, Test Configuration**.
A popup message indicates if the test message was successfully sent to the email address.
10. Click **Save**.

Server Dashboard

The Server dashboard displays the overall summary of the server and the devices that are attached to the server.

After you log in, the Server dashboard is the default landing page in the LSI Storage Authority software. You can troubleshoot, configure, maintain, and monitor the controllers from the Server dashboard. The following figure and table describe this page.

Figure 14: Server Dashboard

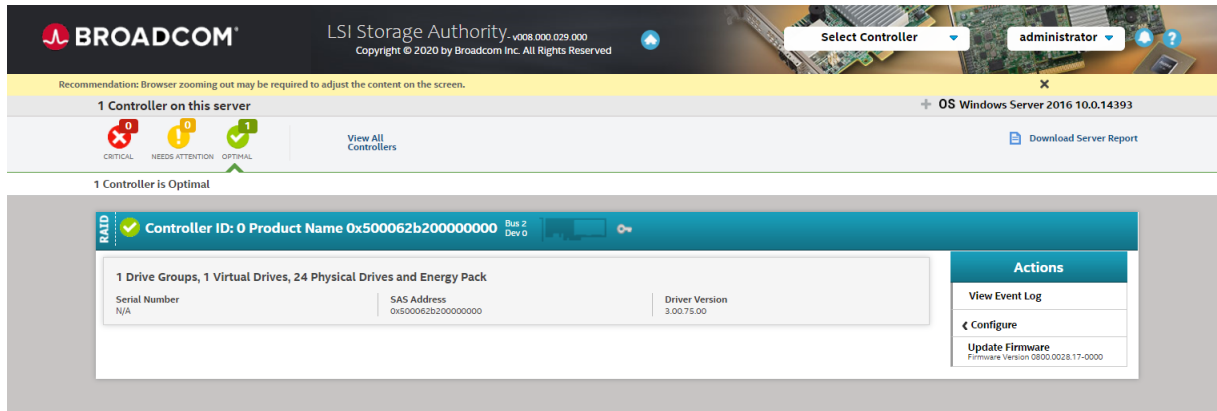

Table 7: Server Dashboard Description



Description
<p>Main Navigation – The main navigation window helps you to traverse among the various views. This navigation is available across all of the pages in the software. The description follows:</p> <ul style="list-style-type: none"> • : Helps you to navigate to the Server dashboard from any page in the software. • Select Controllers: Lists the controllers that you are monitoring. The color-coded controller status icons (red, amber, and green) indicate the health status of all the controllers are based on their criticality. Click a controller to navigate to its dashboard. • Username: Displays the name of the user. <ul style="list-style-type: none"> – Click Settings to perform initial settings. – Click Send Feedback to email your feedback to the Broadcom Technical Support using your Gmail or Microsoft Outlook accounts. – Click View Server Profile and expand the + button to view the server configuration, such as the server IP, server name, OS Name, OS version, OS architecture, and the version of the LSI Storage Authority software that is installed. You can also view the controller information, such as controller hardware, enclosure of the controller, and information about the physical drives and virtual drives associated with the controller. – Click Logout to exit from the software. • : Lets you enable or disable system messages. • : Displays the LSI Storage Authority software context-sensitive help.
<p>User Menu – Provides a method to back out of the Server dashboard and log into the Remote Server Discovery Page or back to the Login Page.</p> <p>Download Server Report – Enables you to download the server report, which contains the following information. Downloading the server report is available only for admin users.</p> <ul style="list-style-type: none"> • LSA Server Report • Information on each individual controller: <ul style="list-style-type: none"> – Diagnosis report – Events report – TTY log – Corpus of individual entity – DEQUEUE log – If Snapdump is not supported – PL log – If Snapdump is not supported – Collection of Snapdump files, including all supporting indexes • LSA developer debug logs
<ul style="list-style-type: none"> • Controller Information: Displays information about the controller. • Controller Personality: Displays the current personality of the controller. • Controller Status: When multiple controllers are connected, the controllers are sorted based on the Bus device function. The controllers are indexed with numbers 0, 1, 2, and so on. • Controller summary • Controller properties • Controller issues • Controller event logs • Allows you to perform the following tasks: <ul style="list-style-type: none"> – Configure the controllers. See Configuration. – Update the controller firmware. – View, download, and clear event logs. – Perform various operations on the controller. See Managing Controllers – Navigate to any of the controllers to see its specific view by clicking the appropriate controller.

Figure 15: View Server Profile Window



Controller Dashboard

The Controller dashboard allows you to perform controller-related actions and view all the information pertaining to a controller.

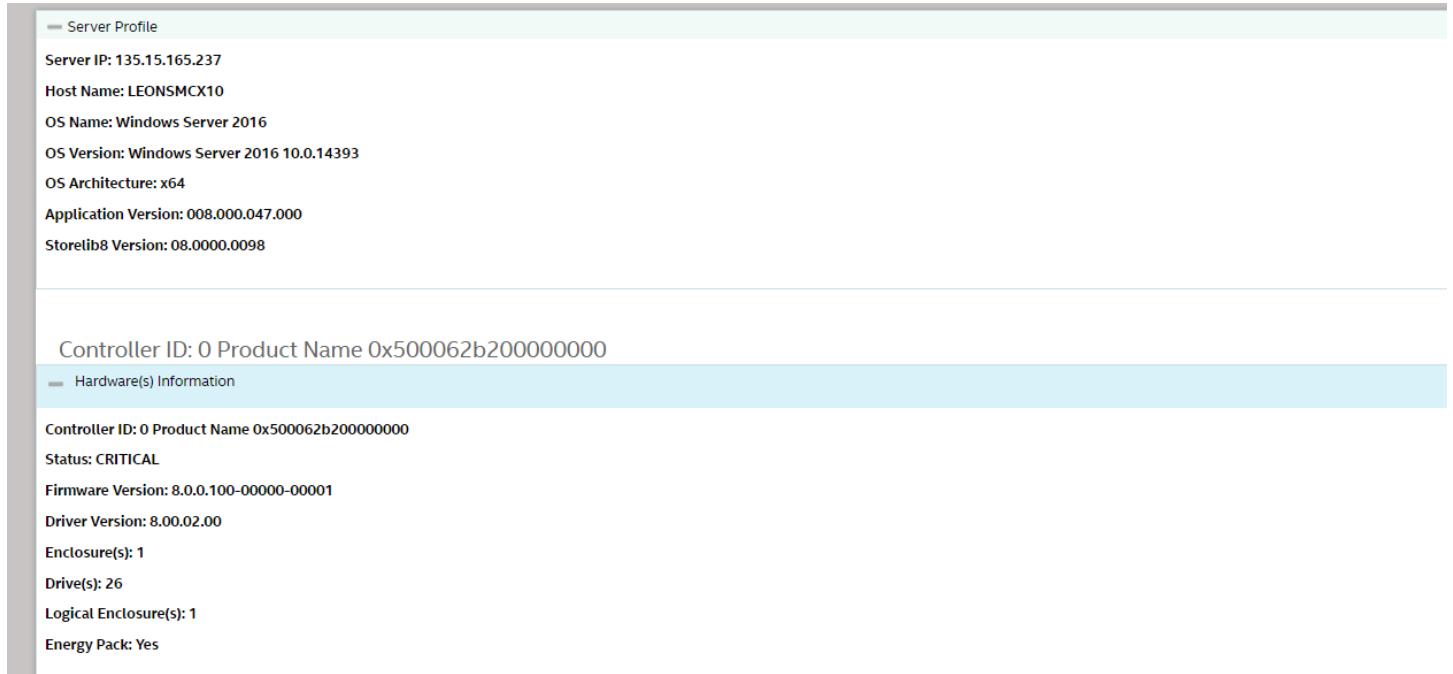
The following figure and table describe this page.

Figure 16: Controller Dashboard

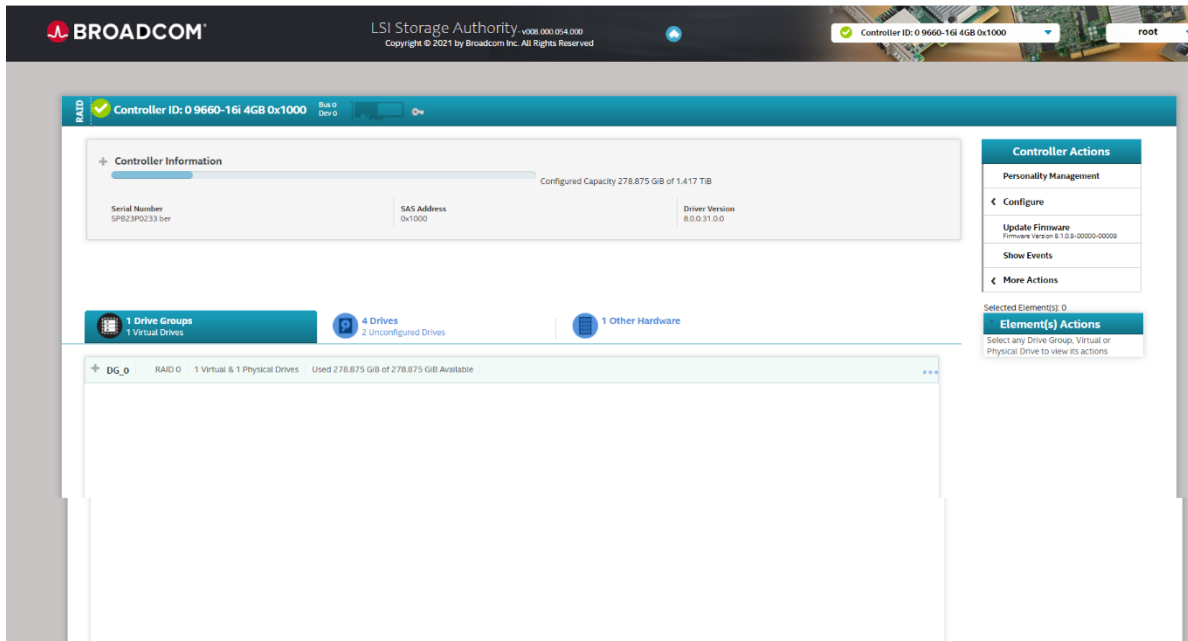



Table 8: Controller Dashboard Description

Callout	Description
1	<p>Controller Summary – Displays the name of the controller. The color-coded icons indicate the status of the controller card. Displays the basic controller properties, such as the controller serial number, vendor ID, SAS address, driver version, device ID, and host interface.</p> <p>Click the  icon to view the advanced properties of the controller, such as the NVRAM details, data protection information properties, BIOS version, firmware properties, drive security properties, and emergency spare properties.</p>
2	<p>Controller Views – Displays the configured drive groups, virtual drives, and physical drives associated with the selected controller card. Also displayed is the hardware, such as enclosures, backplanes, and the CacheVault™ module associated with the controller. All these views are displayed as tabs.</p> <p>Click the  icon to view detailed information about the device. For example, click a drive group to view the associated virtual drives and physical drives. Select any device from the expanded view to perform relevant actions and view device properties.</p>

Callout	Description
3	<p>Controller Actions – Lets you perform some of the following actions:</p> <ul style="list-style-type: none">• Create a configuration.• Clear a configuration.• Manage the Profile.• Manage link speed.• Update the controller firmware.• Enable or disable SSD Guard.• View Premium features.• Show events.• Dump a snapshot when a fault occurs.• Enable or disable drive security.• Import or clear foreign configurations.

Configuration

This section details how to use the LSI Storage Authority software to create and modify storage configurations on systems with Broadcom controllers.

You can create RAID 0, RAID 1, RAID 5, RAID 6, RAID 10, RAID 50, RAID 60, and Spanned R1E (PRL-11) storage configurations.

The supported RAID levels differ or might not be supported for some controllers. For more information, see [LSI Storage Authority Features](#).

You can create the following types of configurations:

- **Simple Configuration** specifies a limited number of settings and has the system select drives for you. This option is the easiest way to create a virtual drive.
- **Advanced Configuration** lets you choose additional settings and customize virtual drive creation. This option provides greater flexibility when creating virtual drives for your specific requirements.

Creating a New Storage Configuration Using the Simple Configuration Option

Simple configuration is the quickest and easiest way to create a new storage configuration. When you select simple configuration mode, the system creates the best configuration possible using the available drives.

NOTE

When a physical drive is in the Prepare for Removal state, you cannot create a virtual drive using that physical drive. To create a virtual drive when the physical drive is in the Prepare for Removal state, you must manually undo the operation by using the Undo Removal option.

Perform the following steps to create a simple storage configuration:

1. On the Server dashboard or on the Controller dashboard, select **Configure > Simple Configuration**.
The **Simple Configuration** window opens.

Figure 17: Simple Configuration Window

The screenshot shows a 'Simple Configuration' window with a teal header bar containing a back arrow and the text 'Go back to Drive Group, Drives and Other Hardware list' and a 'Close' button. Below the header, there is a wrench icon and the title 'Simple Configuration' with a help icon. Underneath is the subtitle 'Step 1/1 : Choose your configuration settings'. The main content area is divided into three sections:

- 1. RAID Level Setting** (Compare and select): A dropdown menu is set to 'RAID 0'. To the right, text reads: 'This RAID level is suitable for high performance with zero data redundancy. Choose this option only for non-critical data.'
- 2. How many virtual drives do you wish to create?**: A dropdown menu is set to '1', followed by the text 'each with capacity of' and another dropdown menu set to '1.64 TB'.
- 3. Miscellaneous Drive Attributes**: An unchecked checkbox labeled 'Assign Hotspare' is on the left. To the right, text reads: 'Hotspare will be assigned depending upon the availability of eligible hotspare candidate drives. A hotspare drive will take over for a drive if a failure happens, ensuring the data remain intact'.

A blue 'Finish' button is located in the bottom right corner of the window.

2. Select a RAID level for the drive group from the drop-down box.
3. (Optional) Click **Compare and Select** to view the detailed information on each RAID level.
When you use simple configuration, the RAID controller supports RAID levels 0, 1, 5, and 6. The window text gives a brief description of the RAID level that you select. The RAID levels that you can choose depend on the number of drives available.
4. Select the number of virtual drives you want to create.
5. Select the capacity of the virtual drives.
Each virtual drive has the same capacity.
6. Select the **Assign Hotspare** check box if you want to assign a dedicated hot spare to the new virtual drive.
If an unconfigured good drive is available, that drive is assigned as a hot spare. Hot spares are drives that are available to replace failed drives automatically in a redundant virtual drive (RAID 1, RAID 5, or RAID 6).
7. Click **Finish**.
A message appears stating that the configuration is successfully created.

Creating a New Storage Configuration Using the Advanced Configuration Option

The advanced configuration procedure provides an easy way to create a new storage configuration. Advanced configuration gives you greater flexibility than simple configuration because you can select the drives and the virtual drive parameters when you create a virtual drive. In addition, you can use the advanced configuration procedure to create spanned drive groups.

NOTE

When a physical drive is in the **Prepare for Removal** state, you cannot create a virtual drive using that physical drive.

Perform the following steps to create an advanced storage configuration.

1. On the Server dashboard or the Controller dashboard, select **Configure > Advanced Configuration**.
The **Advanced Configuration** window opens.

Figure 18: Advanced Configuration Window

← Go back to Drive Group, Drives and Other Hardware list Close

Advanced Configuration Next

Step 1/2 : Choose your new drive group settings.

New **Drive Group DG_0**
21 available unconfigured drive(s)

1. RAID Level Setting (Compare and select)

Single Drive RAID 0 This RAID level is suitable for high performance with zero data redundancy. Choose this option only for non-critical data.

Secure Security will make the virtual drive secure by applying Secure logic to underlying data in the drive

Enable Unmap Enabling the Unmap will reclaim the storage space which is not in use.

Enable Unmap/Write Same Unmap Enabling the Unmap/Write Same Unmap will reclaim the storage space which is not in use

Next

2. Select a RAID level for the drive group from the **Raid Level Setting** list.
3. (Optional) Click **Compare and Select** to view the detailed information on each RAID level.
Also see [RAID Levels](#) for more information.

When you use advanced configuration, the RAID controller supports the following RAID levels.

- Single Drive RAID 0 (SDR0)
- RAID 0
- RAID 1
- RAID 5
- RAID 6
- RAID 10
- RAID 50
- RAID 60

The window text gives a brief description of the RAID level that you select. The RAID levels that you can choose depend on the number of drives available.

NOTE

When any RAID level other than SDR0 is selected, only MDRO drives are listed. The SDR0 RAID level is added to help you to create an SDR0 volume using SDR0 drives.

- (Optional) Select the **Secure** check box if you want to apply the encryption logic to secure the data in the virtual drive.
You can add a hot spare to all of the RAID levels except RAID 0. You can also create a secured virtual drive only when the security capable drives are present. This check box is disabled when there are no secured drives.
- (Optional) Complete one of the following steps to reclaim unused storage space.

NOTE

The following choices are only applicable when Unmap and Write Same Unmap drives are available.

- Select the **Enable Unmap** check box if you want to enable Unmap to reclaim the storage space that is not in use.
- Select the **Enable Unmap/Write Same Unmap** check box if you want to enable Unmap to reclaim the storage space that is not in use.

You can add a hot spare to all RAID levels except RAID 0. Also, you can create a secured virtual drive only when the security capable drives are present. This check box is disabled when there are no secured drives.

- Click **Next**.
- Click **Add Physical Drives** to add physical drives to the drive group.

The **Available Unconfigured Drive(s)** window appears.

Figure 19: Available Unconfigured Drive(s) Window

<input type="checkbox"/>	Enclosure:Slot	Device/Persistent ID	Media	Interface	Capacity	Logical Sector Size	Model	NS/LU Count
<input type="checkbox"/>	EN_372:4	289	HDD	SAS	558.406GiB	4KiB	HUC101860CS4200	1
<input checked="" type="checkbox"/>	EN_372:7	292	HDD	SAS	278.875GiB	512B	ST300MM0006	1
<input type="checkbox"/>	EN_372:8	293	HDD	SAS	278.937GiB	512B	HUC156030CSS200	1
<input type="checkbox"/>	EN_372:9	294	HDD	SAS	278.937GiB	512B	HUC156030CSS200	1
<input type="checkbox"/>	EN_372:10	295	HDD	SAS	278.937GiB	512B	HUC156030CSS200	1
<input type="checkbox"/>	EN_372:11	296	HDD	SAS	278.875GiB	512B	ST300MX0012	1
<input type="checkbox"/>	EN_372:12	297	HDD	SATA	931GiB	512B	ST1000NX0423	1
<input type="checkbox"/>	EN_372:13	298	HDD	SAS	278.937GiB	512B	HUC156030CSS200	1
<input type="checkbox"/>	EN_372:14	299	HDD	SAS	278.875GiB	512B	ST300MM0006	1

Add Physical Drives 1 drive(s) selected.

Refer to the following sections for more information:

- For information on how to add physical drives, see [Adding Physical Drives](#).
- For information on adding hot spare drives to the drive group, see [Adding Hot Spares During Configuration Creation](#).

- Select the span depth using the slider bar.
- Click **Add Virtual Drives** to add virtual drives to the drive group.
The **Virtual Drive Settings** window appears.

Figure 20: Virtual Drive Settings Window

Virtual Drive Settings ? X

558.406 GiB available across 1 selected drive
16 Virtual Drives can be added for a drive group

How many virtual drives do you wish to create?

1 each with capacity of 558.406 GiB

Virtual Drive Name: VDName Strip Size: 256 KiB

Initialization State
No Initialization

Read Policy
No Read Ahead

Write Policy
Write Back

Drive Write Cache Policy
Disabled

Initialization prepares the storage medium for use

- No Initialization**
The new configuration is not initialized, and the existing data on the drives is not overwritten.
- Fast Initialization**
The Firmware erases the first and last 8 MB/MiB of the data area of the virtual drive by writing 0x00 to wipe out any remains of Master boot record (MBR) or partition tables. This operation is extremely fast, so the virtual drive is almost instantly accessible to the user.
- Full Initialization**
A complete initialization is done on the new configuration. You cannot write data to the new virtual drive until the initialization is complete. This process can take a long time if the drives are large.

Add Virtual Drives

For information on configuring virtual drives, see [Adding Virtual Drives](#).

10. Click **Add Virtual Drives**.

11. Click **Finish**.

A confirmation message appears if the storage configuration is successfully completed.

Adding Physical Drives

The **Available Unconfigured Drive** window lists all the available unconfigured physical drives. You can either select each physical drive individually or select all the physical drives based on their respective drive type.

Perform the following steps to add physical drives to the drive group.

1. On the **Available Unconfigured Drives** window, select the corresponding check box of a particular physical drive to add it to the drive group.

The selected physical drives appear in the **Advanced Configuration** window.

You can click the **X** icon to remove the physical drives that you have already added.

2. Click the **ALL** drop-down list.

The physical drives are categorized by the system based on their drive type. For example, *4K drives*, *SAS/SATA drives*, *512K drives*, and so on).

Figure 21: Available Unconfigured Drives – Drive Type Window

Enclosure:Slot	Device/Persistent ID	Media	Interface	Capacity	Logical Sector Size	Model	NS/J	
<input type="checkbox"/>	EN_262 : 0	257	SSD	NVMe	893.75GiB	512B	SAMSUNG MZQLW960HMJP-00003	1
<input type="checkbox"/>	EN_262 : 1	258	SSD	NVMe	893.75GiB	512B	SAMSUNG MZQLW960HMJP-00003	1
<input type="checkbox"/>	EN_368 : 2	283	HDD	SAS	278.937GiB	4KiB	HUC156030CS4204	1
<input type="checkbox"/>	EN_368 : 3	284	HDD	SAS	558.406GiB	4KiB	HUC101860CS4200	1
<input type="checkbox"/>	EN_368 : 4	285	HDD	SAS	558.406GiB	4KiB	HUC101860CS4200	1
<input type="checkbox"/>	EN_368 : 5	286	HDD	SAS	278.937GiB	4KiB	HUC156030CS4204	1
<input type="checkbox"/>	EN_368 : 6	287	HDD	SAS	278.875GiB	512B	ST300MM0006	1
<input type="checkbox"/>	EN_368 : 7	288	HDD	SAS	278.875GiB	512B	ST300MM0006	1
<input type="checkbox"/>	EN_368 : 8	289	HDD	SAS	278.937GiB	512B	HUC156030CS5200	1
<input type="checkbox"/>	EN_368 : 9	290	HDD	SAS	278.937GiB	512B	HUC156030CS5200	1

- a) From the available drop-down list, select the required drive type.
- b) Select the check box that is located on the very first row to select the all the physical drives based on the drive type.

3. Click **Add Physical Drives** to add the selected physical drives to the drive group.

Adding Hot Spares During Configuration Creation

Perform the following steps to add hot spares to the drive group.

1. On the Server dashboard or the Controller dashboard, select **Configure > Advanced Configuration**.

The **Advanced Configuration** window opens.

2. Select **Raid Level Setting > Next**.

The **Add Hot Spares** button will be enabled depending on the RAID level selected and the available drives.

3. Click **Add Hot Spares** to add dedicated hot spare drives to the drive group.

The **Available Unconfigured Drives** window appears, which lists the drives that can be added as hot spares.

You can either select each hot spare individually or select all the hot spares based on type of physical drive that you have selected to add to the drive group.

4. Perform one of the following actions:
 - a) Select the corresponding check box of a hot spare drive to add it to the drive group.
 - b) Select the check box that is located on the very first row to select the all the hot spare drives to add them to the drive group.

Figure 22: Available Unconfigured Drives – Hot Spares

<input type="checkbox"/>	▲ Enclosure:Slot	Device/Persistent ID	Media	Interface	Capacity	Logical Sector Size	Model	NS/LU Count
<input type="checkbox"/>	EN_318 : 16	291	HDD	SAS	278.875GiB	512B	ST300MM0048	1
<input type="checkbox"/>	EN_318 : 17	292	HDD	SAS	278.875GiB	512B	ST300MM0048	1
<input type="checkbox"/>	EN_318 : 18	293	HDD	SAS	278.875GiB	512B	ST300MM0048	1
<input type="checkbox"/>	EN_318 : 19	294	HDD	SAS	278.875GiB	512B	ST300MM0048	1
<input type="checkbox"/>	EN_318 : 20	295	HDD	SAS	278.875GiB	512B	ST300MM0048	1
<input type="checkbox"/>	EN_318 : 21	296	HDD	SAS	278.875GiB	512B	ST300MM0048	1
<input type="checkbox"/>	EN_318 : 22	297	HDD	SAS	278.875GiB	512B	ST300MM0048	1

5. Click **Add Hot Spares** to add dedicated hot spare drives to the drive group.

Adding Virtual Drives

The **Virtual Drive Settings** window enables you to configure and add virtual drives to the drive group. Detailed descriptions for all of the parameters are present in the **Virtual Drive Settings** window.

The virtual drive settings differ or might not be supported for some controllers. For more information, see [LSI Storage Authority Features](#).

Perform the following steps to configure and add virtual drives:

1. Specify the number of virtual drives you want to create.
2. Specify the size of the virtual drives you want to create.
Each virtual drive has the same capacity. If you specify the capacity first and then the number of virtual drives, the virtual drive capacity is adjusted with the available capacity.
3. Enter a name for the virtual drive in the **Virtual Drive Name** field.
The virtual drive name can have a maximum of 15 characters.
4. Select a strip size from the **Strip Size** drop-down list.
5. Specify the initialization policy for the virtual drive. The options follow:
 - **No Initialization**
 - **Fast Initialization**
 - **Full Initialization**

6. Specify the read policy for the virtual drive as **No Read Ahead**.
7. Specify the write policy for the virtual drive. The options follow:
 - **Write Through**
 - **Write Back**
 - **Always Write Back**

The write policy depends on the status of the Energy Pack. If the Energy Pack is not present, is low, is failed, or is being charged, the current write policy switches to Write Through.

8. Specify a drive cache setting for the virtual drive. The options follow:
 - **Default**
 - **Enabled**
 - **Disabled**
9. Click **Add Virtual Drives**.

The newly created virtual drive appears in the **Advanced Configuration** window just below the **Virtual Drives** section.

NOTE

You will lose some drive capacity if you choose drives with uneven and large capacities while creating a virtual drive.

If you want to modify the virtual drive settings before finishing the configuration, click the  icon.

The **Virtual Drive Settings** window opens.

You can modify the settings by clicking **Modify Virtual Drive**.

10. Click **Finish** to successfully add the virtual drive to the drive group.

Clearing the Configuration

You can clear all existing configurations on a selected controller.

NOTE

When an OS, file system, or unknown Boot Partition is present, the **Clear Configuration** command is not be allowed.

1. Navigate to the Controller dashboard whose configurations that you want to clear.
2. Click **Configure** and then click **Clear Configuration**.

A confirmation message appears.

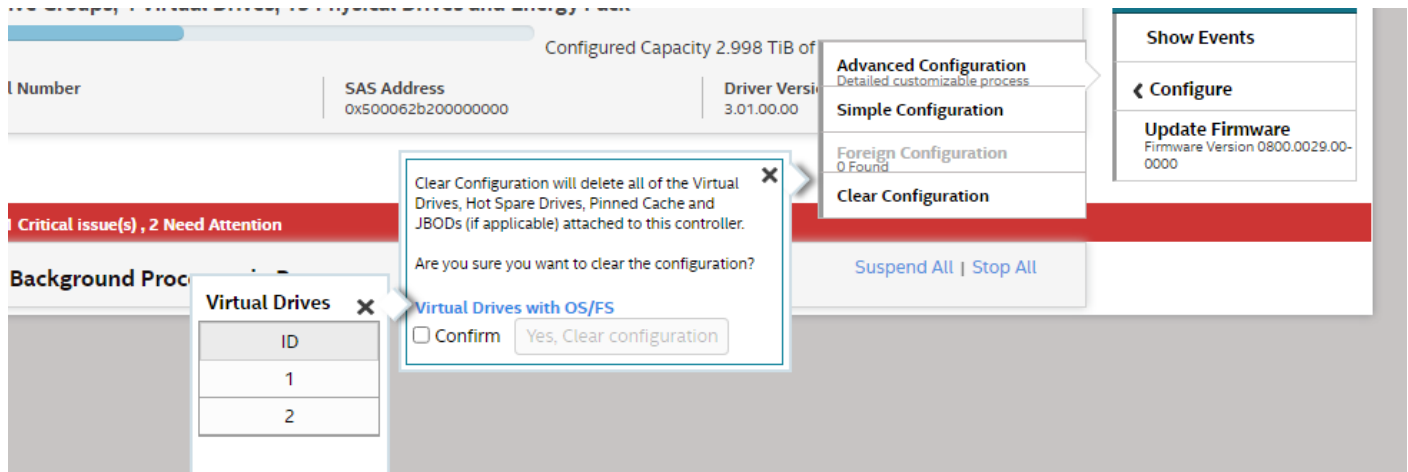
Figure 23: Clear Configuration Dialog

3. Select **Confirm** and click **Yes, Clear configuration** to clear all the existing configurations on the controller.

Importing or Clearing the Foreign Configurations

A foreign configuration is a RAID configuration that already exists on a replacement set of drives that you install in a computer system. You can use the LSI Storage Authority software to import the foreign configuration to the controller or clear the foreign configuration so that you can create a new configuration using these drives.

Perform the following steps to import or clear foreign configurations.

1. Navigate to the Controller dashboard.
2. Click **Configure** and then click **Foreign Configuration**.
The **Foreign Configuration** window appears, which lists all of the foreign configurations.
3. Click one of the following options:
 - **Import All**: Import the foreign configurations from all the foreign drives.
 - **Clear All**: Remove the configurations from all the foreign drives.
4. Click **Re-Scan** to refresh the window.

You can import or clear the foreign configuration on security-enabled drives. See [Importing or Clearing a Foreign Configuration – Security-Enabled Drives](#).

UNMAP Capability Feature

The UNMAP capability feature is a SCSI command that is used with thin provisioned storage arrays. With thin provisioning, after data has been marked as deleted the space is still allocated by the storage array. Because the array is not aware that the data has been deleted, inefficient space usage occurs. The UNMAP feature allows an application or OS to tell the storage array that the disk blocks contain deleted data so the array can deallocate the blocks. This reduces the amount of space that is allocated or in use on the array. This function allows thin provisioning to clean-up after itself and greatly increases the value and effectiveness of thin provisioning.

UNMAP Capability Feature Behavior

LSA behavior for MegaRAID 7.8 designs and later include the following behaviors.

- Display the PD Property, whether the PD (physical drive) is UNMAP capable or not.
- Display the PD Capability, whether the PDs can be used for logical drives (LDs) for the UNMAP feature.
- Lets users modify the UNMAP capability of the volume using the VD Modify (Enable/Disable) Properties option.
- Lets users create an UNMAP supported volume.

LSA behavior for MegaRAID 7.8 designs include the following limitations.

- The UNMAP feature is not supported for EPD/JBOD designs.
- Host software applications cannot support firmware in designs earlier than MegaRAID 7.8 because of the change in the MegaRAID firmware API.

UNMAP Feature Support

When using the UNMAP feature, you can perform the following actions.

- Enable the UNMAP capability during SCSI volume creation.

Figure 24: Enable the UNMAP Feature During Volume Creation

The screenshot shows the 'Advanced Configuration' window for creating a new drive group. At the top, there is a navigation bar with a back arrow and the text 'Go back to Drive Group, Drives and Other Hardware list', and a 'Close' button on the right. Below this, the title 'Advanced Configuration' is followed by a help icon and the text 'Step 1/2 : Choose your new drive group settings.' and a 'Next' button. The main content area shows a 'New Drive Group DG_1' box with '1 available unconfigured drive(s)' below it. Under the heading '1. RAID Level Setting (Compare and select)', there is a dropdown menu set to 'RAID 0' and a descriptive text: 'This RAID level is suitable for high performance with zero data redundancy. Choose this option only for non-critical data.' Below this, the 'Enable SCSI Unmap' checkbox is checked and circled in red, with the text 'Enabling the SCSI Unmap will reclaim the storage space which is not in use.' to its right. A 'Next' button is located at the bottom right of the configuration area.

- Show the PD level UNMAP properties.

Figure 25: Drive Level UNMAP Properties Window

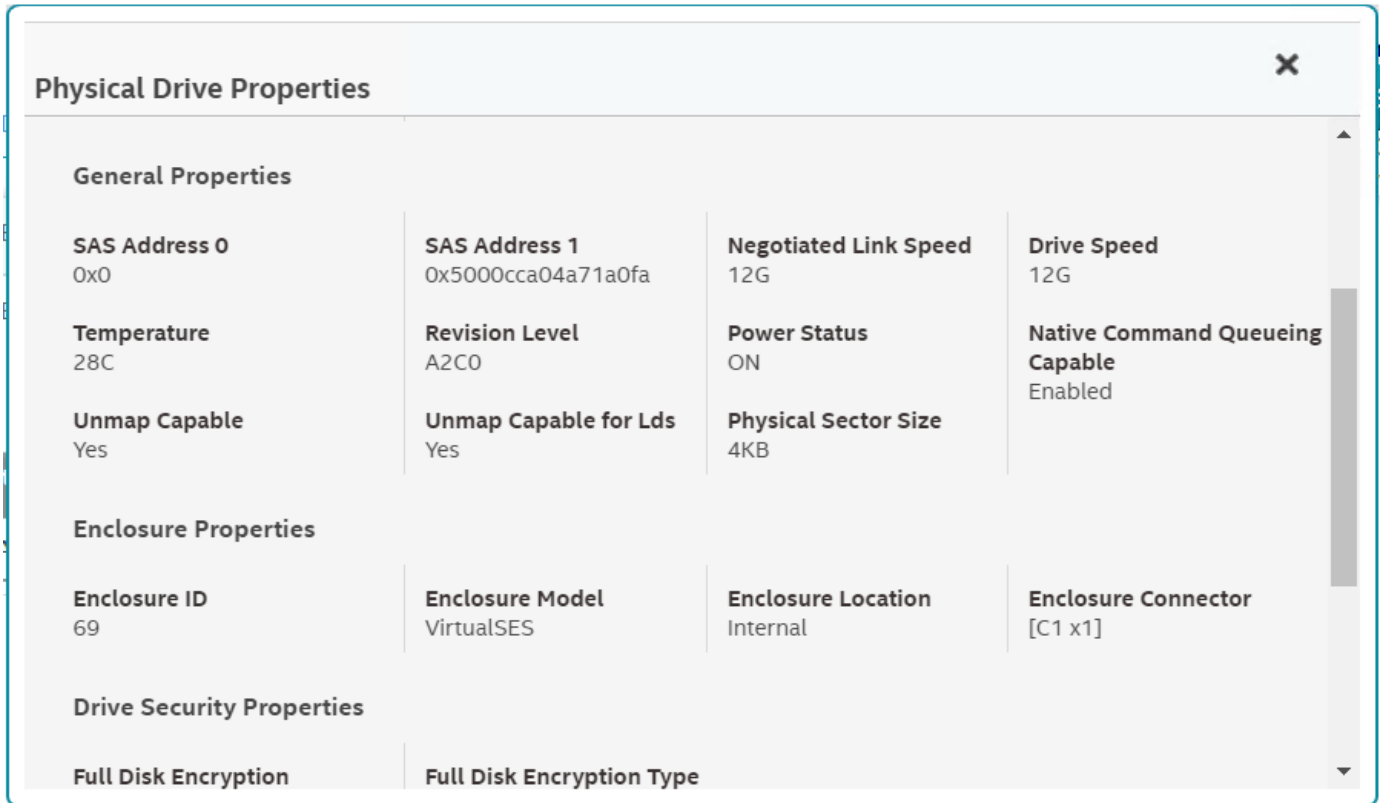

- Let the user modify the UNMAP capability of the Volume using the VD Modify (Enable/Disable) Properties option.

Figure 26: Enable or Disable the SCSI UNMAP Feature

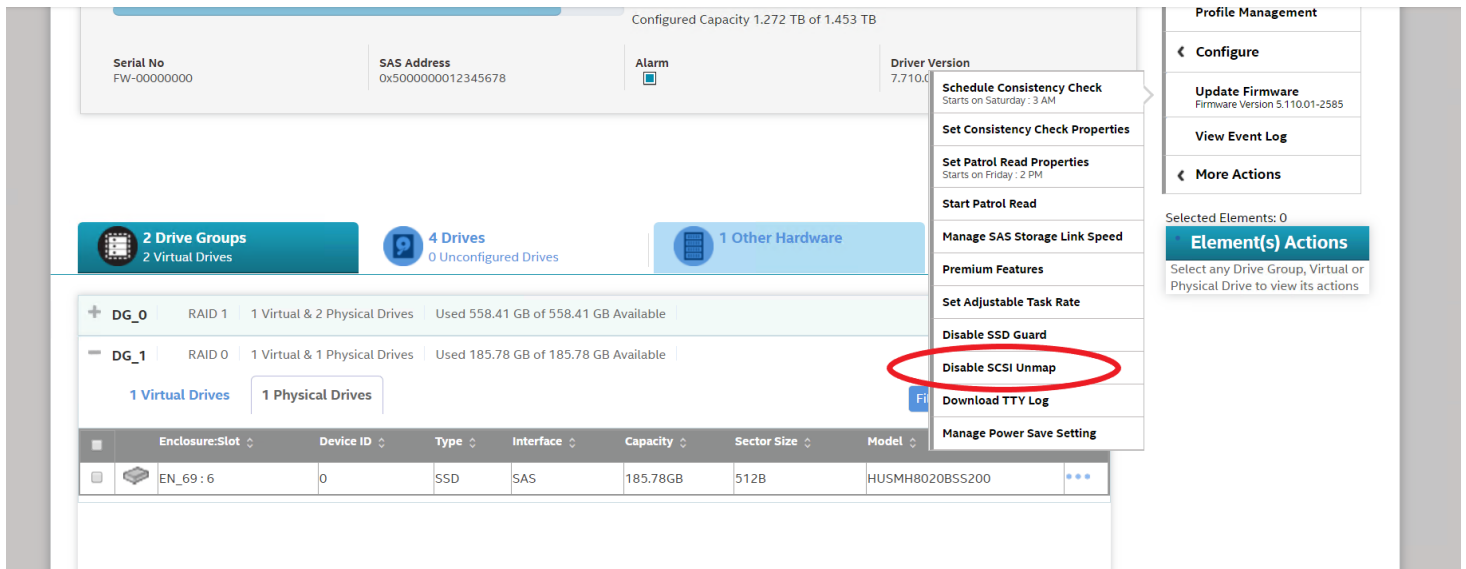

Personality Management

The Personality Management feature allows you to switch between different personality and behavior modes that are supported by your firmware. Using the Personality Management feature, you can switch between the following personality and behavior modes.

Figure 27: Personality Properties

Personality Properties		
Controller Personality RAID	Controller Primary Auto-configure behavior Unconfigured Good	Controller Secondary Auto-configure behavior Unconfigured Good

- Personality modes:
 - RAID
 - HBA/eHBA
- Behavior modes
 - JBOD
 - Secure JBOD
 - Unconfigured Good
 - Single Drive RAID0
 - Single Drive RAID 0 WB
 - Secure Single Drive RAID 0
 - Secure Single Drive RAID 0 WB

For more information on behavior modes and parameters, see [Changing Behavior Modes](#).

Changing Personality Modes

Perform the following steps to switch between different personality modes. Currently, you can switch between RAID and JBOD personality modes.

1. On the Controller dashboard, select **Actions > Personality Management**.

The **Change Personality** page appears.

Figure 28: Change Personality

2. Select the required personality mode from the **Select personality** drop-down list, and then click **Change**.
3. Reboot the system for the changes to take effect.

Changing Behavior Modes

Perform the following steps to change the behavior mode and parameters:

1. In the **Change Personality** page, select the **Change Auto-configure behavior** radio button.
 2. From the **Change Primary Auto-configure behavior** drop-down list, select an appropriate behavior mode. The available behavior modes are based on the current firmware support.
 - **Unconfigured Good** – If a user selects this option, then all the configured drives are converted to Unconfigured Good Drive.
 - **JBOD** – If all the physical drives are in unconfigured good state, once you select the JBOD mode, all the physical drives are automatically converted to JBOD physical drives.
 - **Single Drive RAID 0** – If a user selects this option, then all the physical drives are automatically converted to Single Drive RAID 0.
 - **Single Drive RAID 0 WB** – If a user selects this option, then all the physical drives are automatically converted to Single Drive RAID 0 With Write Back.
 - **Secure JBOD** – If all the physical drives are in unconfigured good state, once you select the JBOD mode, all the physical drives are automatically converted to secure JBOD physical drives.
 - **Secure Single Drive RAID 0** – This option converts all the UGOOD physical drives to Secure Single Drive Raid0 on secure physical drives and Single Drive Raid0 on normal physical drives.
 - **Secure Single Drive RAID 0 WB** – This option auto-secures the SED drive to Single Drive RAID 0 Write Back.
- The **Change Primary Auto-configure behavior** and **Change Secondary Auto-configure behavior** drop-down list selection is disabled if a change is not allowed.
3. (Optional) To immediately change the behavior mode, select the **Configure Now** radio button from the **Change Personality** page.

Figure 29: Configure Now Dialog

The available behavior modes are based on the current firmware support.

- **Unconfigured Good** – If a user selects this option, then all the configured drives are converted to Unconfigured Good Drive.
 - **JBOD** – If all the physical drives are in unconfigured good state, once you select the JBOD mode, all the physical drives are automatically converted to JBOD physical drives.
 - **Single Drive RAID 0** – If a user selects this option, then all the physical drives are automatically converted to Single Drive RAID 0.
 - **Single Drive RAID 0 WB** – If a user selects this option, then all the physical drives are automatically converted to Single Drive RAID 0 With Write Back.
 - **Secure JBOD** – If all the physical drives are in unconfigured good state, once you select the JBOD mode, all the physical drives are automatically converted to secure JBOD physical drives.
 - **Secure Single Drive RAID 0** – This option converts all the UGOOD physical drives to Secure Single Drive Raid0 on secure physical drives and Single Drive Raid0 on normal physical drives.
 - **Secure Single Drive RAID 0 WB** – This option auto-secures the SED drive to Single Drive RAID 0 Write Back.
4. Select the appropriate behavior mode and click **Change**.

Profile Management

Profile management allows you to have multiple configurations supported under each personality mode. Profiles are used to customize the controller to deliver the best performance for that configuration. For example, a profile with no PCI device support can support a higher queue depth than a profile that supports 32 PCI devices.

Changing Profiles

Perform the following steps to switch between different profiles.

1. Select **Actions > Profile Management** on the Controller dashboard.

The **Profile Management** page appears.

Figure 30: Profile Management

	Profile ID	Max Virtual Drives	Max Physical Drives	Max AHCI Devices	Max PCIe Drives	Writeback Volumes Support	Default Profile	Current Profile	Optimized Profile	Pending Profile	Compatible Profile
<input checked="" type="radio"/>	30	240	240	0	32	True	True	True	False	False	True

System restart will be required after saving the changes

Table 9: Profile Management Properties

Property	Description
Profile ID	Indicates the unique identity of the selected profile.
Max Virtual Drives	Indicates the maximum number of virtual drives supported by the controller for the selected profile.
Max Physical Drives	Indicates the maximum number of physical drives supported by the controller for the selected profile.
Max AHCI Devices	Indicates the maximum AHCI devices supported by the controller for the selected profile.
Max PCIe Drives	Indicates the maximum PCIe drives supported by the controller for the selected profile.
Writeback Volumes Support	Indicates whether the Write Back Volumes are supported.
Default Profile	Indicates whether the default profile is supported.
Current Profile	Indicates whether the current profile is supported.
Optimized Profile	Indicates whether the optimized profile associated with the selected personality is used.
Pending Profile	Indicates whether the pending profile is supported.
Compatible Profile	Indicates whether the current profile is compatible.

2. Select the radio button in the first column, and then click **Save** to change the current profile.
3. Reboot the system for the changes to take effect.

Background Operations Support

This section describes the background operations that are supported by the LSI Storage Authority software.

The LSI Storage Authority software provides background Suspend, Resume, Stop, Suspend All, Resume All, and Stop All features that enhance the functionality where the background operations running on a physical drive or a virtual drive can be paused for some time, and resumed later.

The background operations, including **Consistency Check**, **Rebuild**, **Replace**, and **Initialization**, are supported by a **Stop** operation. If any operation is stopped before completion, it is considered to be aborted. An aborted operation cannot be resumed from the place where it was stopped.

To perform **Suspend**, **Resume**, and **Stop** operations, go to the **Background Processes in Progress** window in the Server dashboard or the Controller dashboard, and perform the steps that follow. The **Background Processes in Progress** window is shown in the figure that follows.

Figure 31: Background Processes in Progress Window

1 Background Processes in Progress Resume All | Stop All

Rebuild : Physical Drive : Device/Persistent ID:291 Resume | Stop

1 Drive Groups
1 Virtual Drives

19 Drives
13 Unconfigured Drives

2 Other Hardware
Includes Energy Pack

Selected Element(s): 1

Element(s) Actions

- Make Offline
- Start Locate
- Stop Locate
- Make Failed
- Resume Rebuild
- Stop Rebuild

DG_0 RAID 1 1 Virtual & 2 Physical Drives Used 558.406 GiB of 558.406 GiB Available

1 Virtual Drives 2 Physical Drives Filter

	Enclosure:Slot	Device/Persistent ID	Media	Interface	Capacity	Logical Sector Size	Model	NS/LU Count
<input type="checkbox"/>	EN_318:15	290	HDD	SAS	558.406GiB	512B	ST600MM0099	1
<input checked="" type="checkbox"/>	EN_318:16	291	HDD	SAS	558.406GiB	512B	ST600MM0099	1

- **Suspend** – Click **Suspend** to suspend the background operation taking place at that particular point of time. When the operation is paused, the **Resume** option appears instead of the **Suspend** option.
- **Resume** – Click **Resume** to resume the operation from the point of its last suspension.
- **Stop** – Click **Stop** to stop the ongoing active operation.
- **Suspend All** – Click **Suspend All** to suspend all active operations. This option is enabled only if one or more background operations are in active state.
- **Resume All** – Click **Resume All** to resume all the paused operations from the point they were paused. This option is disabled if no operations are paused.
- **Stop All** – Click **Stop All** to stop all the active operations.

While refreshing the LSA Client or the LSA GUI, if there is any delay such as the **Replace** progress bar not displaying the progress of the **Replace** operation or the **Replace** progress bar itself not getting displayed for small-size volumes, set the maximum event grouping time gap to 0 in the `LSA.conf` file to see the real-time events. For more information on setting up LSA retrieve real-time events.

Note that setting real-time events has an impact on the performance of LSA.

Managing Controllers

The LSI Storage Authority software enables you to monitor the activity of all the controllers in the system and the devices attached to them.

- [Viewing Controller Properties](#)
- [Running a Consistency Check](#)
- [Running a Patrol Read](#)
- [Managing SAS Storage Link Speed](#)
- [Managing PCIe Storage Lane Speed](#)
- [Setting the Adjustable Task Rates](#)
- [Managing Power-Save Settings](#)
- [Enabling and Disabling SSD Guard](#)
- [Discarding Pinned Cache](#)
- [Downloading the TTY Log](#)
- [Updating the Controller Firmware](#)
- [Firmware Activation Status](#)
- [Managing Factory Defaults](#)
- [Drive Spin Up](#)

Viewing Controller Properties

The Controller dashboard displays basic controller properties. Click the  icon to see the advanced properties of the controller.

Select the **Click to download all the controller properties** link to download the properties in the .JSON format.

Figure 32: Basic and Advanced Controller Properties

Controller Information			
Configured Capacity 0 KiB of 10,199 TiB			
Serial Number N/A	SAS Address 0x500062b200000000	Driver Version 8.00.01.00	PCI Address 00:02:00:0
PCI_Vendor_ID 0x1000	PCI Subsystem Vendor ID 0x1000	PCI Device ID 0x00a5	PCI Subsystem ID 0x4600
Chip Temperature 60 C (140 F)			
Advanced Properties			
NVRAM Present Yes	Shield State Supported Yes	Energy Pack Yes	NVRAM Size 128 KiB
SSD Guard on SMART Error Enabled			
Power State Properties			
Power savings on unconfigured drives Enabled	Power saving on hot spares Enabled	Spin Down Time 30 mins	
Firmware Properties			
Package Version MANIFEST PKG VER: 8.0.30.00028-0000-00000	Firmware Version FW Version:8.030.28-00000	All Online Controller Reset Enabled	
Security Properties			
Security Capable Yes	Security is enabled. No		
Emergency Spare Properties			
Emergency Spare Unconfigured Good & Global Hot Spare	Emergency spare for SMARTer Enabled		
Personality Properties			
Controller Personality RAID	Controller Primary Auto-configure behavior Unconfigured Good	Controller Secondary Auto-configure behavior Unconfigured Good	
Snapdump Properties			
Save Count through reset 4			

Table 10: Basic and Advanced Controller Properties

Property	Description
Basic Controller Properties	
Serial Number	The serial number of the controller.
SAS Address	The SAS address of the controller.
Driver Version	The driver version of the controller.
PCI Address	A unique address assigned to the controller.
PCI_Vendor_ID	A unique controller ID assigned to a specific vendor.
PCI Subsystem Vendor ID	Additional vendor ID information about the controller.
PCI Device ID	The device ID that is assigned by the manufacturer.
PCI Subsystem ID	Additional device ID that is assigned by the manufacturer.
Chip Temperature	Indicates the temperature of the controller.
Advanced Properties	
NVRAM Present	Indicates if a nonvolatile random access memory (NVRAM) is present on the controller.
Shield State Supported	Indicates whether the controller supports the shield state.

Property	Description
Energy Pack	Indicates whether the controller supports the associated energy pack status management.
NVRAM Size	Indicates the capacity of the controller's NVRAM.
SSD Guard on SMART Error	Indicates if the SSD Guard feature is enabled on the controller.
Power State Properties	
Power savings on unconfigured drives	Indicates if the power savings on the unconfigured drives is enabled.
Power saving on hot spares	Indicates if the power savings on the hot spares is enabled.
Spin Down Time	Shows the drive spin down time in minutes.
Firmware Properties	
Package Version	The firmware package version of the controller.
Firmware Version	The firmware version of the controller.
All Online Firmware Update	Indicates if the online firmware update feature is enabled in the firmware.
Security Properties	
Security Capable	Indicates the security (encryption) feature status on the controller.
Security is enabled	Indicates whether the security is enabled.
Emergency Spare Properties	
Emergency Spare	Indicates the emergency spare controller properties. It can be set to Unconfigured Good or Unconfigured Good and Global Hotspare .
Emergency spare for SMARTer	Indicates if emergency hot spare drives are commissioned for predictive analysis.
Personality Properties	
Controller Personality	Shows the current personality mode.
Controller Primary Auto-configure behavior	Shows the primary auto-configure behavior.
Controller Secondary Auto-configure behavior	Shows the secondary auto-configure behavior.
Snap Dump Properties	
Save Count through reset	Save the count through the reset.

Running a Consistency Check

A consistency check operation verifies the correctness of the data in virtual drives that use RAID 1, 5, 6, 10, 50, and 60 configurations. For example, in a system with parity, checking consistency means calculating the data on one drive and comparing the results to the contents of the parity drive. You should periodically run a consistency check on fault-tolerant virtual drives.

Because RAID 0 does not provide data redundancy, you cannot run a consistency check on these RAID volumes.

To run a consistency check, you must first set the consistency check properties, and then either you can schedule a consistency check to be run at a defined interval chosen by you or you can start the consistency check operation immediately.

Setting the Consistency Check Properties

Perform the following steps to set the properties for a consistency check.

1. In the Controller dashboard, select **More Actions > Set Consistency Check Properties**.
The **Set Consistency Check Properties** dialog appears.
2. Choose one of the two options:
 - **Continue Consistency Check and Fix Error** – The RAID controller continues the consistency check, and if any errors are found, fixes them.
 - **Stop Consistency Check On Error** – The RAID controller stops the consistency check operation if it finds any errors.
3. Click **Save**.

Scheduling a Consistency Check

Perform the following steps to schedule a consistency check:

1. In the Controller dashboard, select **More Actions > Schedule Consistency Check**.
The **Schedule Consistency Check** page appears.

Figure 33: Schedule Consistency Check Dialog

2. (Optional) Click **Load Factory Defaults** to restore any modified settings back to the default factory setting.
This option loads default factory values in the existing **Schedule Consistency Check** page.
3. In the **Set Mode** dialog, select an available mode. The following options are available:
 - **Enable** – Runs a consistency check concurrently on all virtual drives or one drive at a time.
 - **Disable** – Disables the consistency check.

4. Set the maximum number of virtual drives.
5. Set the desired interval at which you want to run the consistency check.
 - a) Select an appropriate date and time range.
6. Click **Next**.

The **Schedule Consistency Check** page appears, which allows you to add virtual drives on which you want to perform a consistency check.

7. Click **Add Virtual Drives**.

The **Available Virtual Drive** dialog appears, which lists all the virtual drives present in the selected drive group.

Figure 34: Available Virtual Drive Dialog

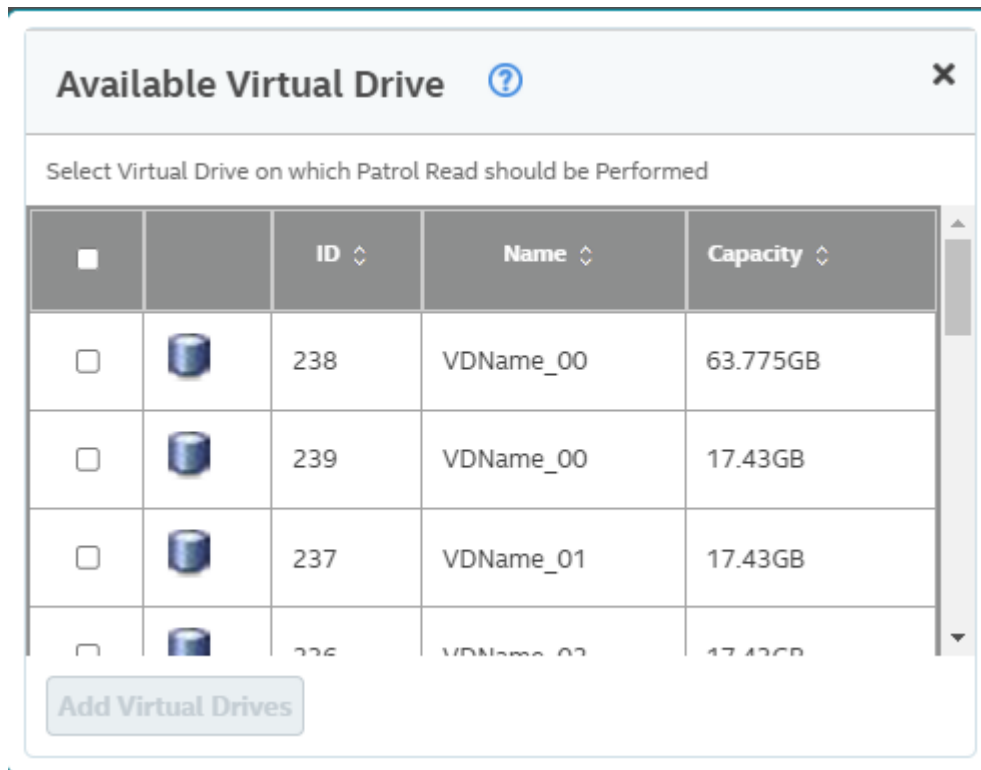

8. You can either select each virtual drive individually by selecting the corresponding check box of a particular virtual drive or select all the virtual drives by selecting the check box that is located on the first row.
9. Click **Add Virtual Drives**.

The consistency check runs based on the frequency or interval that is chosen by you. You can also monitor the progress of the consistency check operation. See [Background Operations Support](#).
10. Click **Save**.
11. (Optional) If you want to perform a consistency check immediately, from the **Controller View** section, select the virtual drive on which you want to perform a consistency check, and select **More Actions > Start Consistency Check**.

If you attempt to run a consistency check on a virtual drive that has not been initialized, a confirmation dialog appears.

Device Reporting Order

1. In the Controller dashboard, select **More Actions > Device Reporting Order**.

The **Device Reporting Order** page appears.

Figure 35: Device Reporting Order Dialog

2. In the Device Reporting Order dialog, select an order for device reporting. The following options are available.
 - Logical drives are reported after JBOD devices
 - Logical drives are reported prior to JBOD devices
3. Set the **First DevicePersistentID**.

Running a Patrol Read

A patrol read periodically verifies all sectors of the drives connected to a controller, including the system reserved area in the RAID configured drives. You can run a patrol read for all RAID levels and for all hot spare drives. A patrol read is initiated only when the controller is idle for a defined period and has no other background activities. You can set the patrol read properties and start the patrol read operation, or you can start the patrol read without changing the properties.

Scheduling a Patrol Read

Perform the following steps to schedule a patrol read.

1. In the Controller dashboard, select **More Actions > Schedule Patrol Read**.

The **Schedule Patrol Read** dialog appears.

Figure 36: Schedule Patrol Read Dialog

2. (Optional) Click **Load Factory Defaults** to restore any modified settings back to the default factory setting. This option loads default factory values in the existing **Schedule Patrol Read** dialog.
3. Perform the following steps to set the properties:
 - a) Select an operation mode for the patrol read from the **Set Mode** drop-down list. The following modes are available:
 - **Enable** – The patrol read operation runs automatically at the time interval you specify or when you manually start it by selecting **Start Patrol Read** from the Controller dashboard.
 - **Disable** – The patrol read operation does not run.
 - b) (Optional) Specify a maximum number of physical drives to include in the patrol read concurrently. The count must be a number from 1 to the maximum number of configurable physical devices.
 - c) Select the frequency at which the patrol read operation runs from the drop-down list.
 - d) Select the month, day, and year on which to start the patrol read.
 - e) Select the time of day to start the patrol read.
4. Click **Next**.
5. Select the virtual drives for which you want to set the patrol read properties.
6. Click **Finish**.
You can monitor the progress of the patrol read operation. See [Background Operations Support](#).

Starting a Patrol Read Operation

Perform the following steps to start a patrol read operation.

1. In the Controller dashboard, select **More Actions > Start Patrol Read**.
A warning message appears.
2. Click **Start Patrol Read** to start a patrol read operation.
You can monitor the progress of the patrol read operation. See [Background Operations Support](#).

Stopping a Patrol Read Operation

Perform the following step to stop a patrol read operation.

In the Controller dashboard, select **More Actions > Stop Patrol Read**.

Managing SAS Storage Link Speed

The Managing SAS Storage Link Speed feature lets you change the link speed between the controller and an expander or between the controller and a drive that is directly connected to the controller. All phys in a SAS port can have different link speeds or can have the same link speed. You can select a link speed setting. However, if phys in a SAS port have different link speed settings and if a phy is connected to a drive or an expander, the firmware overrides the link speed setting you have selected and instead uses the common maximum link speed among all the phys.

Perform the following steps to change the link speed.

1. In the Controller dashboard, select **More Actions > Manage SAS Storage Link Speed**.

The **Manage SAS Storage Link Speed Dialog** dialog appears.

Figure 37: Manage SAS Storage Link Speed DialogManage SAS Storage Link Speed [?](#)

SAS/SATA Phy Information

Phy	Status	Receptacle Name	Port Number	Select Link Speed	Negotiated Speed	Connected Device
0	DISABLED	N/A	N/A		N/A	
1	DISABLED	N/A	N/A		N/A	
2	DISABLED	N/A	N/A		N/A	
3	DISABLED	N/A	N/A		N/A	
4	DISABLED	N/A	N/A		N/A	
5	DISABLED	N/A	N/A		N/A	
6	DISABLED	N/A	N/A		N/A	
7	DISABLED	N/A	N/A		N/A	
8	DISABLED	N/A	N/A		N/A	
9	DISABLED	N/A	N/A		N/A	
10	DISABLED	N/A	N/A		N/A	
11	DISABLED	N/A	N/A		N/A	
12	DISABLED	N/A	N/A		N/A	
13	DISABLED	N/A	N/A		N/A	
14	DISABLED	N/A	N/A		N/A	
15	DISABLED	N/A	N/A		N/A	
16	OPTIMAL	C0.1	16	6.0Gb/s	N/A	
17	OPTIMAL	C0.1	16	6.0Gb/s	N/A	
18	OPTIMAL	C0.1	16	6.0Gb/s	N/A	
19	OPTIMAL	C0.1	16	6.0Gb/s	N/A	
20	OPTIMAL	C0.0	16	6.0Gb/s	N/A	

- The **Phy** column displays the system-supported phy link values.
 - The **Status** column displays the status of the link speed.
 - The **Port Number** column displays the port numbers.
 - The **Select Link Speed** column displays the phy link speeds.
 - The **Negotiated Speed** column displays the current negotiated speed of the phy.
 - The **Connected Device** column displays the device connected to the phy.
2. Select the desired link speed from the **Select Link Speed** field using the drop-down selector. The link speed values are **MAX**, **6.0Gb/s**, **12.0Gb/s**, or **22.5Gb/s**.

By default, the link speed in the controller is **MAX** or the value last saved by you. The **12.0Gb/s** link speed is supported for some SAS-3 expanders.

3. Click **Save**.

The link speed value is now reset. The change takes place after you restart the system.

Managing PCIe Storage Lane Speed

A lane represents a set of differential signal pairs, one pair for transmission and one pair for reception, similar to SAS phys.

The Managing PCIe Storage Lane Speed feature allows you to change the lane speed between a controller and an expander or between the controller and a drive that is directly connected to the controller. LSA 2.4 and later versions support both SAS/SATA topologies as well as PCIe topologies using the same device phys to manage the lane speed.

Perform the following steps to change the lane speed.

1. In the Controller dashboard, select **More Actions > Manage PCIe Storage Lane Speed**.

The **Manage PCIe Storage Lane Speed Dialog** appears.

Figure 38: Manage PCIe Storage Lane Speed Dialog

Manage PCIe Storage Lane Speed ⓘ

View PCIe Information

lane	Status	Receptacle Name	Port Number	Current Clock Mode	Current Speed	Connected Device
16	OPTIMAL	C0.1	16	0	N/A	
17	OPTIMAL	C0.1	16	0	N/A	
18	OPTIMAL	C0.1	16	0	N/A	
19	OPTIMAL	C0.1	16	0	N/A	
20	OPTIMAL	C0.0	20	0	N/A	
21	OPTIMAL	C0.0	20	0	N/A	
22	OPTIMAL	C0.0	20	0	N/A	
23	OPTIMAL	C0.0	20	0	N/A	
24	OPTIMAL	C1.1	24	0	N/A	
25	OPTIMAL	C1.1	24	0	N/A	
26	OPTIMAL	C1.1	24	0	N/A	
27	OPTIMAL	C1.1	24	0	N/A	
28	OPTIMAL	C1.0	28	0	N/A	
29	OPTIMAL	C1.0	28	0	N/A	
30	OPTIMAL	C1.0	28	0	N/A	
31	OPTIMAL	C1.0	28	0	N/A	

Change Link Speed

Port Number	Lane Speed
16	16GT/s ▼
20	16GT/s ▼
24	16GT/s ▼
28	16GT/s ▼

System restart will be required after saving the changes

- The **Lane** column displays the system-supported lane values.
 - The **Status** column displays the status of the lane.
 - The **Receptacle Name** column name of the receptacle.
 - The **Port Number** column displays the port numbers.
 - The **Current Clock Mode** column displays the current clock mode.
 - The **Current Speed** column displays the current speed.
 - The **Connected Device** column displays the connected device name.
2. Select the desired lane speed from the **Lane Speed** field using the drop-down selector.
The lane speed values are **2.5GT/s**, **5GT/s**, **8GT/s**, and **16GT/s**.
By default, the lane speed in the controller is **8GT/s** or the value last saved by you.
 3. Click **Save**.
The lane speed value is now reset. The change takes place after you restart the system.

Setting the Adjustable Task Rates

Perform the following steps to set the adjustable task rates.

1. In the Controller dashboard, select **More Actions** > **Set Adjustable Task Rate**.
The **Set Adjustable Task Rates** dialog appears.

Figure 39: Set Adjustable Task Rate Dialog

Task	Priority Percentage
Rebuild Rate	30
Patrol Rate	30
BGI Rate	30
Consistency Check Rate	30
OCE Rate	30

2. Enter changes, as needed, in the following task rates:
 - **Rebuild Rate** – Enter a number from 1 to 100 to control the rate at which the rebuild is performed on a drive when it is necessary.
The higher the number, the faster the rebuild will occur (and the system I/O rate might be slower as a result).
 - **Patrol Rate** – Enter a number from 1 to 100 to control the rate at which patrol reads are performed.

The patrol read monitors drives to find and resolve potential problems that might cause drive failure. The higher the number, the faster the patrol read will occur (and the system I/O rate might be slower as a result).

- **BGI Rate (Background Initialization Rate)** – Enter a number from 1 to 100 to control the rate at which virtual drives are initialized in the background.

Background initialization establishes mirroring or parity for a RAID virtual drive while allowing full host access to the virtual drive. The higher the number, the faster the initialization will occur (and the system I/O rate might be slower as a result).

- **Check Consistency Rate** – Enter a number from 1 to 100 to control the rate at which a consistency check is performed.

A consistency check scans the consistency data on a fault-tolerant virtual drive to determine if the data has become corrupted. The higher the number, the faster the consistency check is performed (and the system I/O rate might be slower as a result).

- **OCE Rate** – Enter a number from 1 to 100 to control the rate at which online capacity expansion occurs.

3. Click **Save** to set the new task rates.

Managing Power-Save Settings

Dimmer Switch Technology

Powering drives and cooling drives represent a major cost for data centers. The MegaRAID Dimmer Switch (power save) feature set reduces the power consumption of the devices that are connected to a MegaRAID controller. Reducing the power consumption helps to share resources more efficiently and lowers the cost.

- Dimmer Switch 1 – Spin down unconfigured disks. This feature is configurable and can be disabled.
- Dimmer Switch 2 – Spin down hot spares. This feature is configurable and can be disabled.

Perform the following steps to manage the power-save settings.

1. In the Controller dashboard, select **More Actions > Manage Power Save Settings**.

The **Manage Power Save Settings** dialog appears.

Figure 40: Manage Power Save Settings Dialog

← Go back to Drive Group, Drives and Other Hardware list Close

Manage Power Save Settings ?

Power save(Dimmer Switch) technology that conserves energy by spinning down idle drives. The controller will automatically spin up those drives from power save mode whenever necessary.

Specify the power save settings below:

Unconfigured Drives

Hot Spare Drives

Spin Down Time:

Ensure that if the drives are idle for the specified time, then the drives will go to power save mode.

Finish

2. Select the **Unconfigured Drives** check box to let the controller enable the unconfigured drives to enter the Power Save mode.
3. Select the **Hot Spare Drives** check box to let the controller enable the hot spare drives to enter the Power Save mode.
4. Select the spin down time using the drop-down list from the **Spin Down Time:** field.
The drive standby time can be 30 minutes, 1 hour, and 2 hours through 24 hours.
5. Click **Finish** to save the settings.
A confirmation message appears.

Enabling and Disabling SSD Guard

Solid state drives (SSDs) are known for their reliability and performance. The SSD Guard technology, which is unique to MegaRAID controller cards, increases the reliability of SSDs by automatically copying data from a drive with potential to fail to a designated hot spare or newly inserted drive. A predictive failure event notification, or S.M.A.R.T command, automatically initiates this rebuild to help preserve the data on an SSD whose health or performance falls below par.

1. In the Controller dashboard, select **More Actions > Enable SSD Guard** to enable the SSD Guard feature.
2. To disable the SSD Guard feature, select **More Actions > Disable SSD Guard**.

Discarding Pinned Cache

If the controller loses access to one or more virtual drives, the controller preserves the data from the virtual drive. This preserved cache is called as pinned cache. This cache is preserved until you import the virtual drive or discard the cache. As long as there is pinned cache, you cannot perform certain operations on the virtual drive.

ATTENTION

If there are any foreign configurations, import the foreign configuration before you discard the pinned cache. Otherwise, you might lose data that belongs to the foreign configuration.

Perform the following steps to discard the pinned cache.

1. In the Controller dashboard, select **More Actions** > **Discard Preserved Cache**.

NOTE

The **Discard Preserved Cache** option is displayed only if pinned cache is present on the controller.

A message appears, prompting you to confirm your choice.

2. Select **Confirm** and click **Yes, Discard**.

Downloading the TTY Log

You can download the TTY log file, which contains the firmware terminal log entries for the controller. The log information is shown as total number of entries available on the firmware side.

Perform the following to download the TTY log file.

In the Controller dashboard, select **More Actions** > **Download TTY Log**.

The TTY log file is downloaded, which has the serial number of the controller. The format of the TTY log file is provided below as an example.

Example: `Json_<controller serial number>_TTY.txt`

Updating the Controller Firmware

The LSI Storage Authority software enables you to update the controller firmware.

Perform the following steps to update the controller firmware.

1. Navigate to the Controller dashboard.
2. Click **Update Firmware**.

The **Update Firmware** dialog appears and displays the components, current version, selected version, current security version, and the selected security version, when applicable.

Figure 41: Update Firmware Dialog

←
Go back to Drive Group, Drives and Other Hardware list

Update Firmware
?

Select the file from which you want to update
New controller FW will be used immediately after update process completes.

Update

Components	Current Version	Selected Version	Current Security Version	Selected Security Version
PACKAGE	8.3.0.100-00000-00023	8.2.0.150-00000-00002	N/A	N/A
FMC	8.3.0.100-00000-00023	8.2.0.150-00000-00002	00.00.00.00	00.00.00.00
BSP	8.3.0.100-00000-00023	8.2.0.150-00000-00002	00.00.00.00	00.00.00.00
FW	8.3.0.100-00000-00023	8.2.0.150-00000-00002	00.00.00.00	00.00.00.00
HIIM	08.03.02.00	08.02.04.00	00.00.00.00	00.00.00.00
HIIA	08.03.02.00	08.02.04.00	00.00.00.00	00.00.00.00
BIOS	0x08030200	0x08020500	00.00.00.00	00.00.00.00

Online Activation

Offline Activation

Please select confirm to flash the selected firmware

Confirm
 Flash Firmware

- Click **Browse** to locate and open the `.rom` file.

During a PSOC firmware upgrade (or downgrade), a message is displayed if the same firmware version exists on the controller or if the selected version is lower than the current version. Reconfirm the process by clicking the confirm check box (force option).

- Click **Update**.
- Select either **Online Activation** or **Offline Activation**.

By default, **Online Activation** is selected.

NOTE

The **Online Activation** and **Offline Activation** radio buttons are applicable only to SAS4xxx controllers. SAS3xxx controllers depend on the Online Firmware Update bit, which is usually set to **Online Activation**.

An **Offline Activation** requires a system reboot.

6. Select the **Confirm** check box and click **Flash Firmware**.

After the update is complete, a message appears to confirm the success of the update. The message also displays the new version of the controller firmware.

NOTE

For SAS3xxx controllers, you can flash both the BIOS and EFI using any of the BIOS or EFI radio buttons. A separate BIOS and EFI flash can be performed only on IR/IT controllers.

Firmware Activation Status

The LSI Storage Authority software enables you to monitor the component version information and firmware activation status.

Perform the following steps to access the component version information and firmware activation status.

1. Navigate to the Controller dashboard.
2. Click **More Actions**.

The **Firmware Activation Status** window appears. The **Firmware Activation Status** window displays the component version information and activation status.

Figure 42: Firmware Activation Status

[← Go back to Drive Group, Drives and Other Hardware list](#)

Firmware Activation Status ?

Component(s) Version(s) Information

Components	Current Version	Current Security Version
FW	8.3.0.100-00000-00023	00.00.00.00
FMC	8.3.0.100-00000-00023	00.00.00.00
BSP	8.3.0.100-00000-00023	00.00.00.00
BIOS	0x08030200	00.00.00.00
HIIM	08.03.02.00	00.00.00.00
HIIA	08.03.02.00	00.00.00.00
PACKAGE	8.3.0.100-00000-00023	N/A
PSOC	18.00	N/A

Activation Status

Properties	Description
Activation Status	No Component Images need activation
Download In Progress	false
Cache Dirty	0%
Offline Activation Required	false
Pending Count	0
Key Update Pending	false

Managing Factory Defaults

The LSA Storage Authority software enables you to view the list of modified factory values and provides an option to restore the modified values to the default factory settings.

Perform the following steps to restore factory defaults.

1. Navigate to the Controller dashboard.
2. Select **Element(s) Actions > Factory Defaults**.

The **Factory Defaults** window appears. The **Factory Defaults** window displays the modified factory default properties.

Figure 43: Factory Defaults

[← Go back to Drive Group, Drives and Other Hardware list](#)

Factory Defaults [?](#)

Below are the list of modified factory default properties

Element	Properties	Current	DEFAULT
Controller	SES Association Type In MultiPath Config	LUN	Target Port
Controller	Patrol Read Percentage	70	30
Controller	BGI Percentage	80	30
Controller	Consistency Check Percentage	99	30

[Restore Factory Defaults](#)

[View All](#)

3. (Optional) Click **View All** to view the default values.
4. Click **Restore Factory Defaults** to restore any modified settings back to the default factory setting.

Drive Spin Up

The LSA Storage Authority software enables you to view information about drives. Drives must be spun up to view all of the drive information.

Perform the following steps to spin up the drives.

1. Navigate to the Controller dashboard.
2. Select **More Actions > Power State Actions > Spin up drives**.

The **Start/Spin-Up Drives** window appears.

Figure 44: Start/Spin-Up Drives

Select the drives you would like to start or spin-up from the table below. Filter

Spin-Down Drives

<input type="checkbox"/>	▲ Enclosure:Slot	Device/Persistent ID	Media	Interface	Capacity	Logical Sector Size	Model
<input type="checkbox"/>	EN_326:0	283	HDD	SAS	278.875GiB	512B	AL14SEB030N
<input type="checkbox"/>	EN_326:1	284	HDD	SAS	278.875GiB	512B	AL14SEB030N
<input type="checkbox"/>	EN_326:4	287	HDD	SAS	278.875GiB	512B	AL14SEB030N
<input type="checkbox"/>	EN_326:5	288	HDD	SAS	278.875GiB	512B	AL14SEB030N
<input type="checkbox"/>	EN_326:7	290	HDD	SAS	278.875GiB	512B	AL14SEB030N
<input type="checkbox"/>	EN_326:8	291	HDD	SAS	278.875GiB	512B	AL14SEB030N
<input type="checkbox"/>	EN_326:9	292	HDD	SAS	278.875GiB	512B	AL14SEB030N
<input type="checkbox"/>	EN_326:10	293	HDD	SAS	278.875GiB	512B	AL14SEB030N
<input type="checkbox"/>	EN_326:11	294	HDD	SAS	278.875GiB	512B	AL14SEB030N

Spin-Up 0 drive(s) selected.

3. Select the drive(s) you want to spin up.
4. Click **Spin-Up**.
Two warning dialogs appear.
5. Click **Yes** for the following dialog.

Starting or spinning up multiple drives can take some time. Are you sure you want to start or spin-up the drive(s)?

Advanced Software

Advanced software offers premium features that the LSI Storage Authority software supports on certain RAID controllers.

The advanced software includes the following features:

- FastPath
- CacheCade Pro 2.0 SSD Read/Write Caching software
- SafeStore

The software licensing authorizes you to enable the advanced software features. You must obtain the activation key, which will enable you to use the advanced software features present in the controller.

Activating Advanced Software

The **Premium Features** window allows you to use the advanced software features.

Perform the following steps to enable the activation key to use the advanced controller features:

1. In the Controller dashboard, select **Actions > Advanced Software Options**.

The **Advanced Software Options** window opens.

Figure 45: Advanced Software Options Window

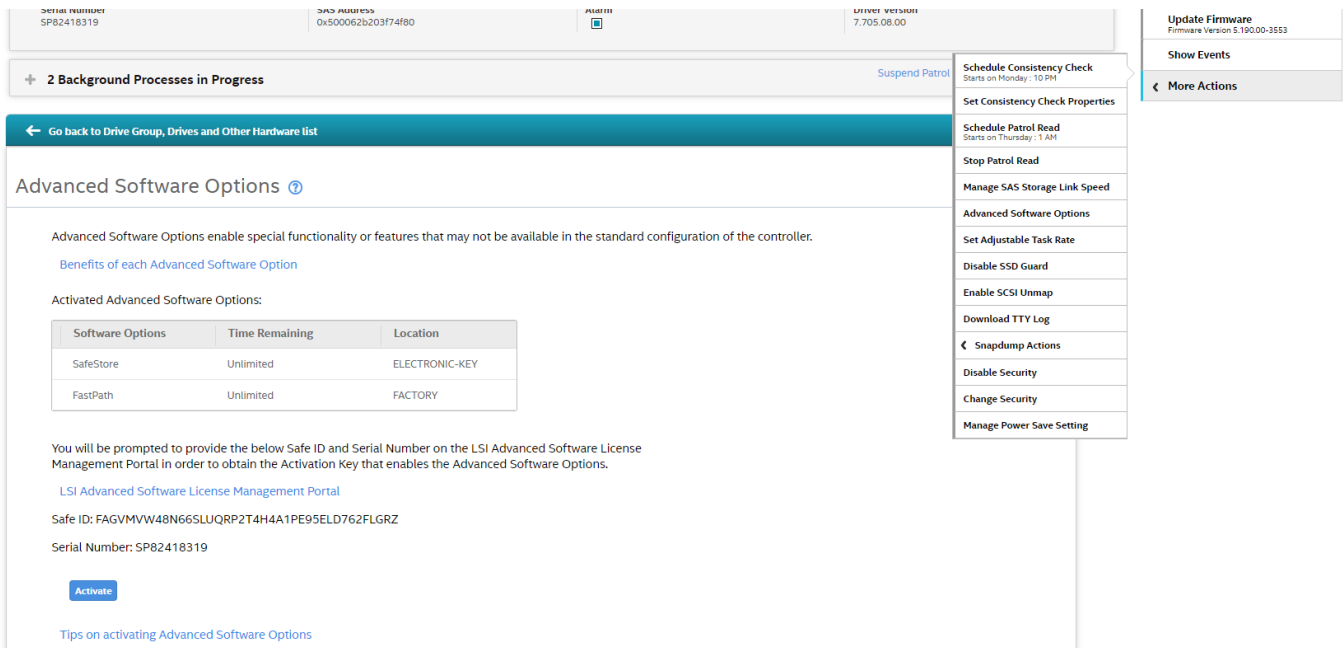

The Activated Advanced Software Options table consists of the Software Options, Time Remaining, and Location columns.

- The Software Options column displays the list of advanced software options present in the controller.
- The Time Remaining column displays the time remaining for the software option to deactivate.
- The Location column displays the key location from which the option is activated.

(Optional) For more information on the benefits of these features, click the **Benefits of each Advanced Software Option** link.

- Click the **LSI Advanced Software License Management Portal** link to obtain the license authorization code and the activation key.

Both the **Safe ID** field and the **KeyId** field consist of a predefined value generated by the controller.

For more information on activating the advanced software options, click the **Tips on activating Advanced Software Options** link.

- Click **Activate**.
- Enter the activation key in the text box provided.
- Click **Next**.

After you click **Next**, one of the following two scenarios occurs:

- Depending on whether you are activating an unlimited key or a trial key, the relevant **Activate Features – Summary** dialog appears. See [Advanced Software Status Summary](#).
- If you have entered an invalid key or if there is a key mismatch, relevant error messages are shown. See [Application Scenarios and Messages](#).

Advanced Software Status Summary

After you enter the activation key and click **Next**, the **Activate Features** window appears as shown in the following figure. It displays the list of the advanced software features along with their *former status* and *new status* in the controller.

Figure 46: Activate Features Window – Summary

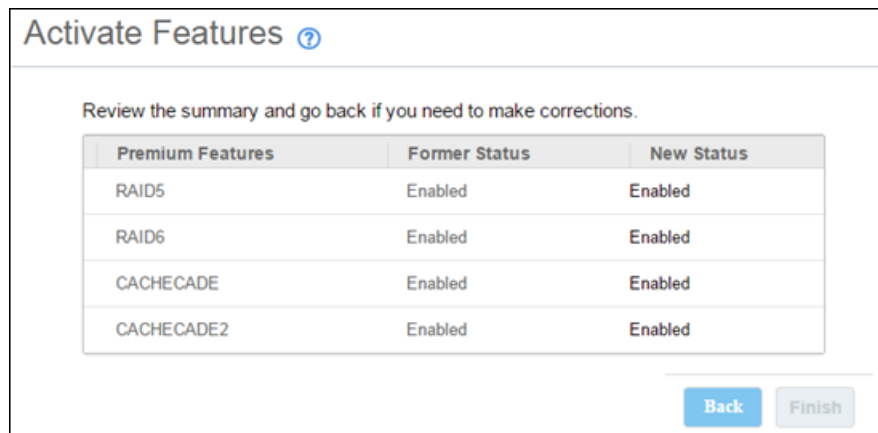

- The Premium Features column displays the currently available software in the controller.
- The Former Status column displays the status of the available advanced software before entering the activation key.
- The New Status column displays the status of the available advanced software, after entering the activation key.

To activate the premium features, perform the following steps.

- Click **Finish**.

The status of the advanced software is enabled, and the advanced features are secured in the key vault.

- Click **Back** to return to the previous window to change any selections.

Activating a Trial Key

When you activate a trial key, the message `This trial software expires in 30 days.` appears.

Figure 47: Activating Trial Software

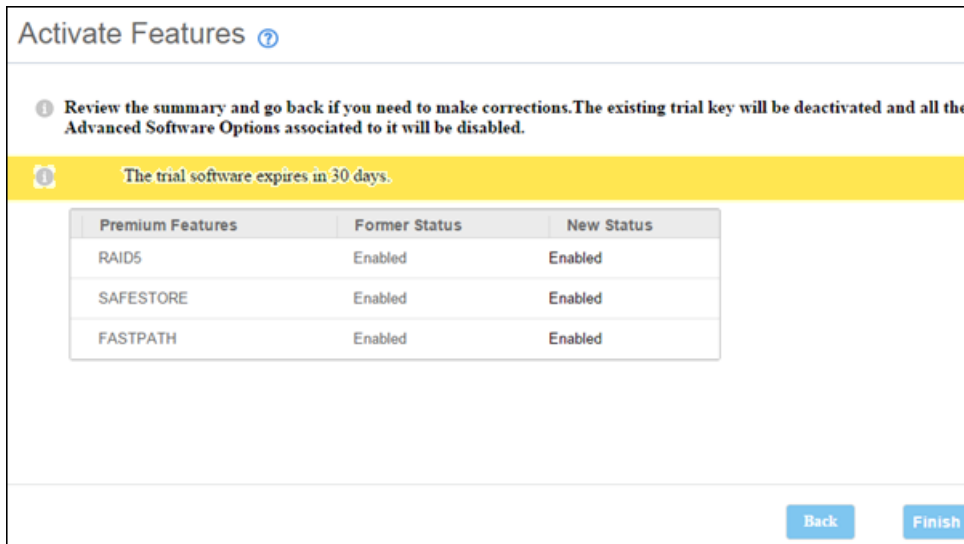

Activating an Unlimited Key over a Trial Key

When you activate an unlimited key over a trial key, the following message appears:

The existing trial key will be deactivated and all the Advanced Software Options associated to it will be disabled.

Figure 48: Activating an Unlimited Key over a Trial Key

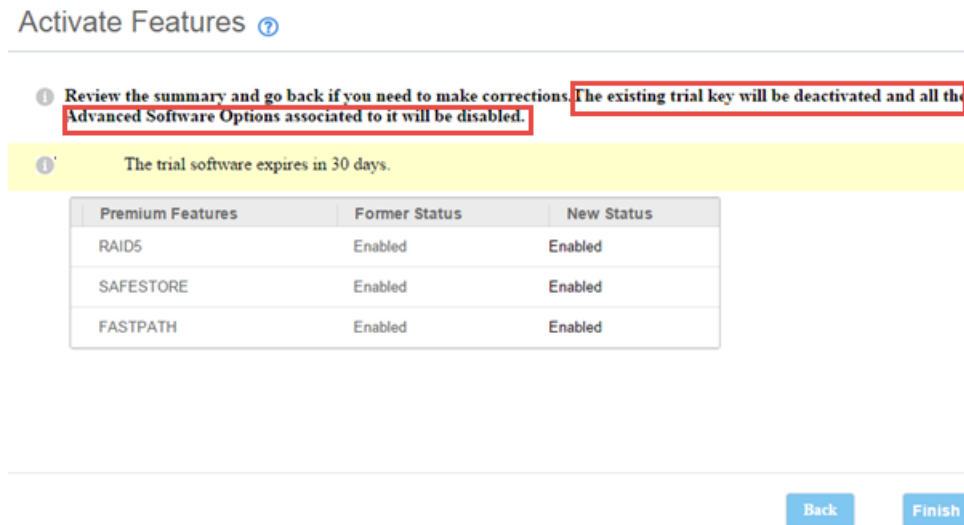

Reusing the Activation Key

If you are using an existing activated key, the features are transferred to the keyvault. A message appears stating that the options are already activated for the key and transferred to the keyvault.

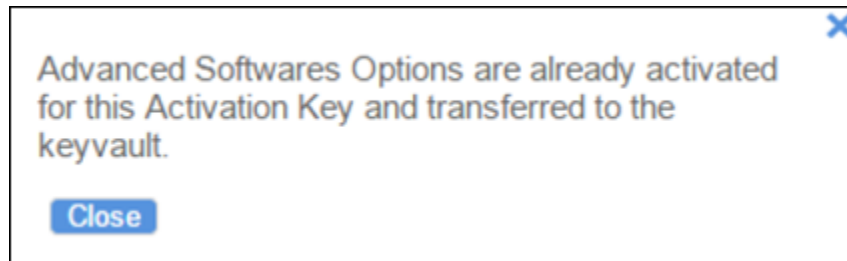
Figure 49: Reusing the Activation Key

Application Scenarios and Messages

Scenario 1

If you enter an *invalid* activation key, an error message is displayed.

Scenario 2

If you enter an *incorrect* activation key, and if a mismatch exists between the activation key and the controller, an error message is displayed.

Securing Advanced Software

You can transfer the advanced software from the controller to the key vault. This feature is conditional, and appears only when the key vault and the unsecured keys exist.

Perform the following steps to secure the advanced software.

1. In the **Advanced Software Options** window, click **Configure Key Vault**.
The **Activate Features** window opens.

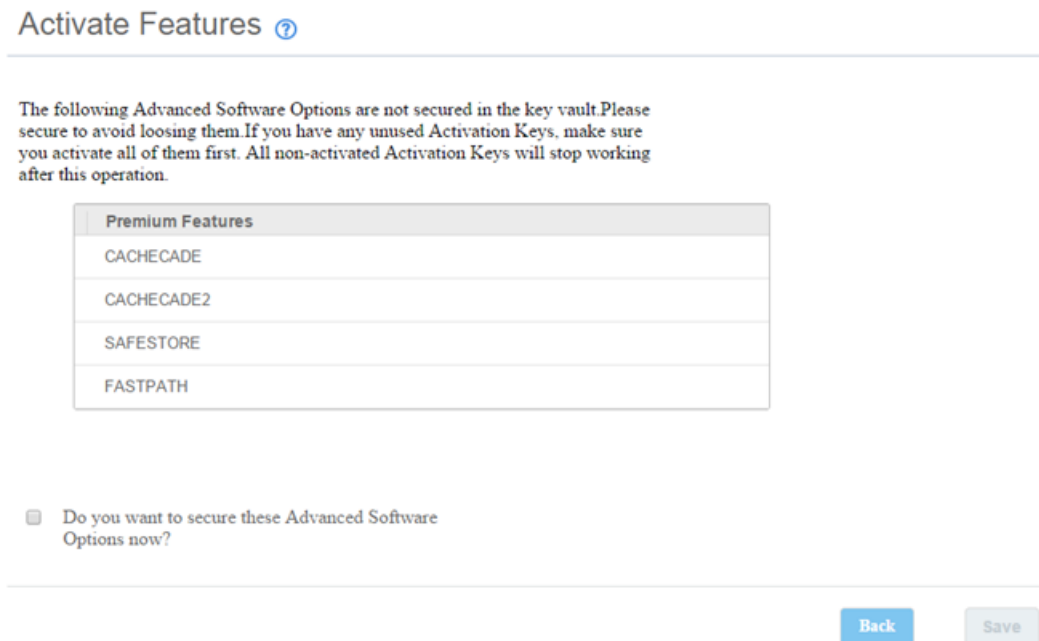
Figure 50: Activate Features Window – Secure Key Vault Option

2. Select the **Do you want to secure these Advanced Software Options now?** check box, if you want to secure the advanced software.

After you select the check box, the **Save** button is enabled. This situation implies that the advanced software is secured in the key vault.

Configuring the Key Vault (Re-Hosting Process)

Re-hosting is a process of transferring the advanced software features from one controller to another. This feature is conditional and appears only if the re-hosting process is necessary, and when both the key vault and the unsecured keys are present at the same time. To implement the re-hosting process, perform the following steps.

1. In the **Premium Features** window, click **Configure Key Vault**.

The following window appears.

Figure 51: Premium Features Window – Configure Key Vault

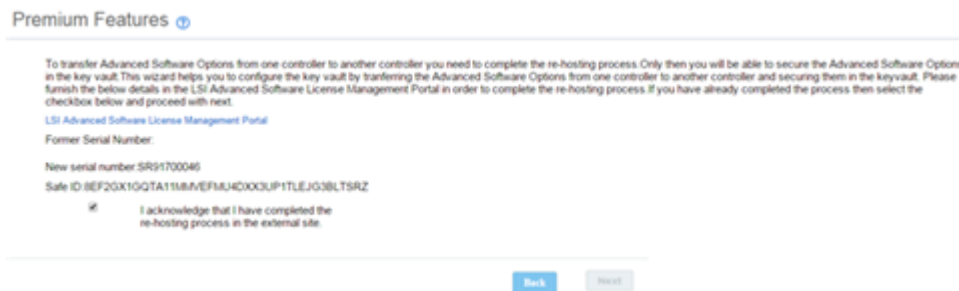

2. Select the **I acknowledge that I have completed the re-hosting process in the external site.** check box.
3. Click **Next**.

The **Next** button in the screen is enabled only if you selected the check box.

The **Activate Features** window appears.

Figure 52: Activate Features Window – Configure Key Vault Window



4. Click **Finish**, and the advanced software options are secured in the key vault.

Implementing the Re-Hosting Process

If you want to transfer the advanced software options from one controller to another, use the re-hosting process. The re-hosting process makes sure that these options are secured in the key vault. You have to configure the key vault to complete the re-hosting process. To implement the re-hosting process, perform the following steps.

1. In the **Premium Features** window, click **Configure Key Vault**.

The following window appears.

Figure 53: Premium Features Window – Re-hosting Complete

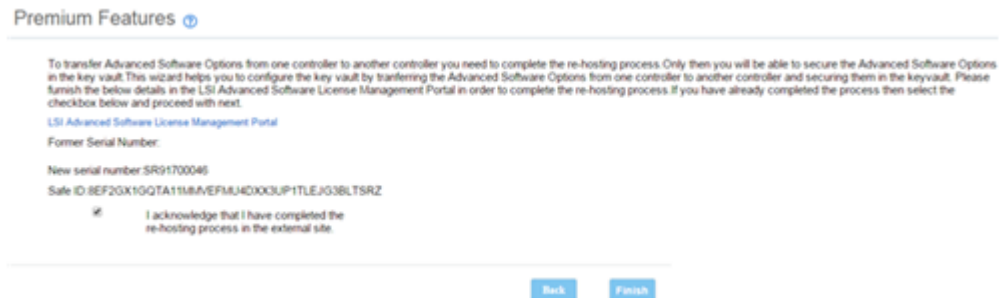

2. Select the **I acknowledge that I have completed the re-hosting process in the external site.** check box. This setting makes sure that the advanced software features are transferred to the controller.
3. Either click **Finish**, and the advanced software options are secured in the key vault, or click **Cancel** if you do not want to activate the re-hosting process

Snapdump Feature

The Snapdump feature is a way to save a snapshot of the debug information at fault time. The intention is to collect all required information to be able to find a root cause of the defect at the first instance of defect detection. This ensures that multiple defect reproductions are not required for debugging.

This section describes the LSA design `get` and `set` Snapdump properties and how to download the respective dump files from the firmware.

Snapdump Feature Support

Using the Snapdump feature support, the user can enable or disable the Snapdump feature. If the Snapdump feature is enabled, the user can set the `CacheOffloadLimit` properties of the Snapdump. If the user chooses to disable the Snapdump feature, the `CacheOffloadLimit` modification is not applicable and is disabled at the client level.

Figure 54: Snapdump Properties Menu

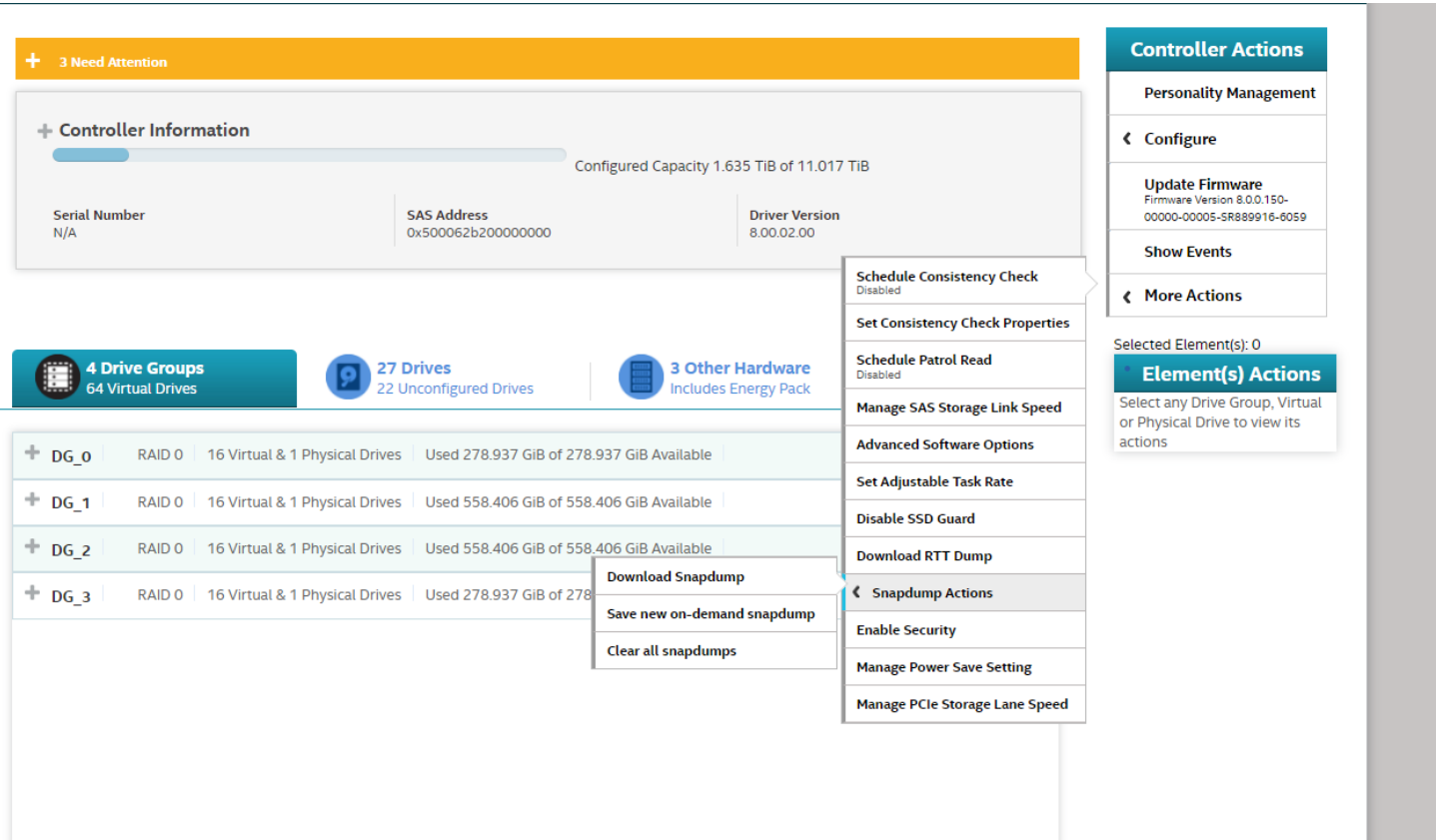

The user can set the Snapdump properties from the **Snapdump Actions** menu of the controller dashboard. Snapdump properties can be edited when using advanced software.

Retrieving the Snapdump Output

The LSI Storage Authority software has an option to read the Snapdump logs from the firmware. In certain cases, firmware might hold multiple Snapdump logs. The LSA displays the list of available Snapdump logs with file ID and file size details.

Snapdump logs are generated when Snapdump is triggered by either the firmware or by a user. When a Snapdump log is generated, the user can select the which Snapdump log to downloaded.

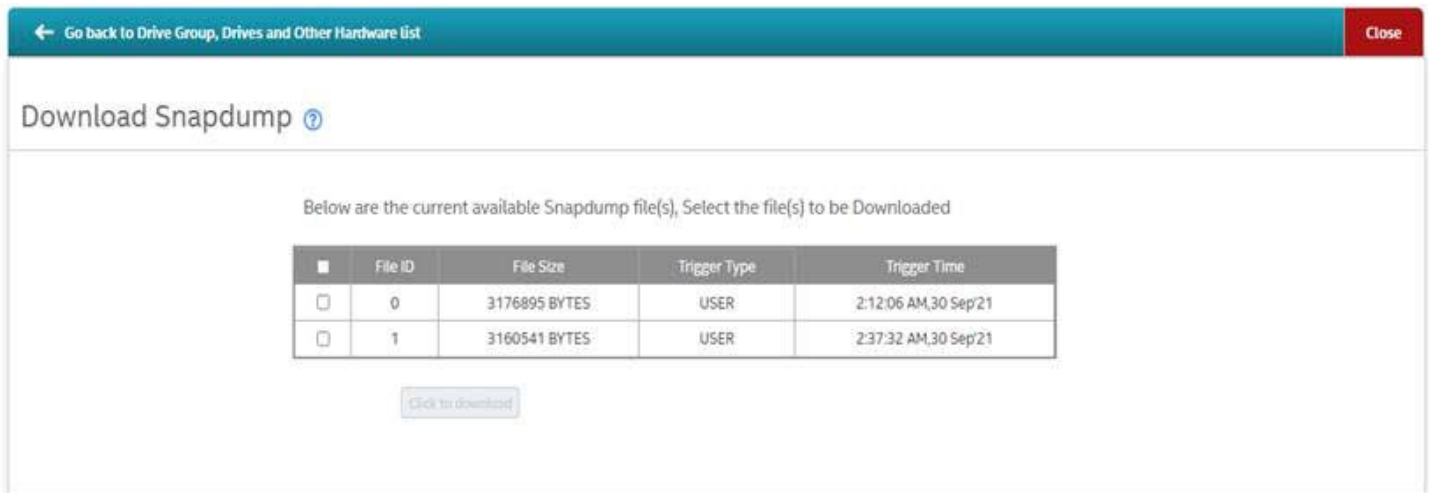
Figure 55: Download Snapdump Window**NOTE**

The user can only download a Snapdump log when the Snapdump feature is enabled.

Deactivating Trial Software

When you want to deactivate a trial software, use the **Deactivate All Trial Software** wizard.

Perform the following steps to enable the deactivate trial software button:

1. Click **Deactivate All Trial Software** in the **Premium Features** window.
A confirmation dialog appears.

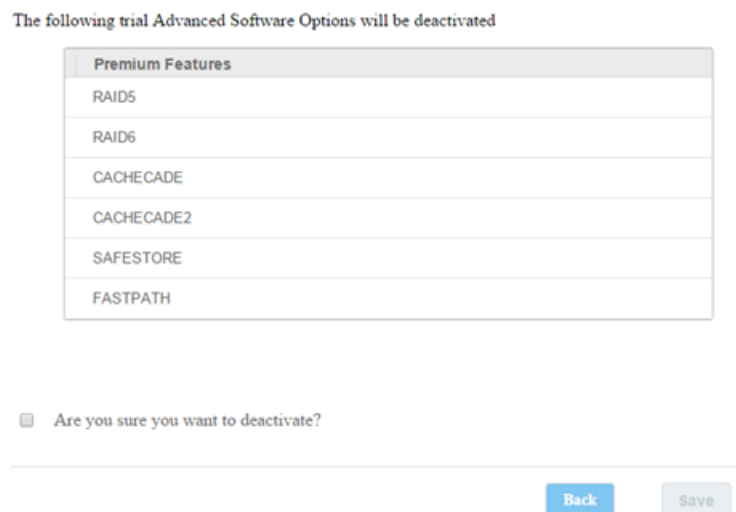
Figure 56: Deactivate All Trial Software – Confirmation Window

2. Select the **Are you sure you want to deactivate?** check box, if you want to deactivate the software applications, that are used with a trial key.
3. Click **Save**.

The trial software is deactivated.

Using the CacheCade™ Pro 2.0 Feature

ATTENTION

The CacheCade feature is supported on controllers where applicable.

The CacheCade Pro 2.0 read and write software eliminates the need to manually configure hybrid arrays by intelligently and dynamically managing frequently accessed data and copying it from HDD volumes to a higher performance layer of SSD cache. Copying the most accessed data (hot spot) to Flash cache relieves the primary HDD array from time-consuming transactions, which allows for more efficient hard disk operation, reduced latency, and accelerated read and write speeds.

The CacheCade Pro 2.0 software is the industry's first software solution that offers both read and write controller-based caching on SSDs, dramatically enhancing the performance gains achieved by the previous generation CacheCade software. With the addition of write caching support, read/write-intensive workloads, such as Exchange server, high performance computing (HPC) applications, Web 2.0, and other I/O-intensive OLTP database system workloads, experience dramatic performance improvements.

Creating a CacheCade Virtual Drive

Perform the following steps to create a CacheCade virtual drive.

1. In the Server dashboard or the Controller dashboard, select **Configure > CacheCade – SSD Caching Configuration**. The **CacheCade – SSD Caching Configuration** window is displayed.

Figure 57: CacheCade – SSD Caching Configuration Window

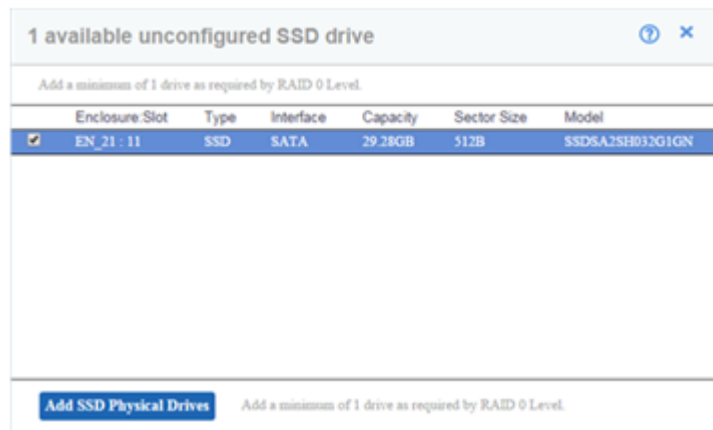

2. Select a RAID level for the drive group. For example, select **RAID 0**.
3. (Optional) Click **Compare and Select** to view the detailed information on each RAID level.
4. Select the **Encryption** check box if you want to apply the encryption logic to secure the data in the virtual drive.
5. Click **Next**.
6. Click **Add SSD Physical Drives** to add SSD drives to the drive group. The **Available Unconfigured SSD Drives** window appears.

Figure 58: Available Unconfigured SSD Drive Window

7. Select the SSD physical drives, and click **Add SSD Physical Drives**.
8. Click **Add CacheCade – SSD Caching Virtual Drives** to add CacheCade virtual drives to the drive group. The **CacheCade – SSD Caching Virtual Drive Settings** window appears.

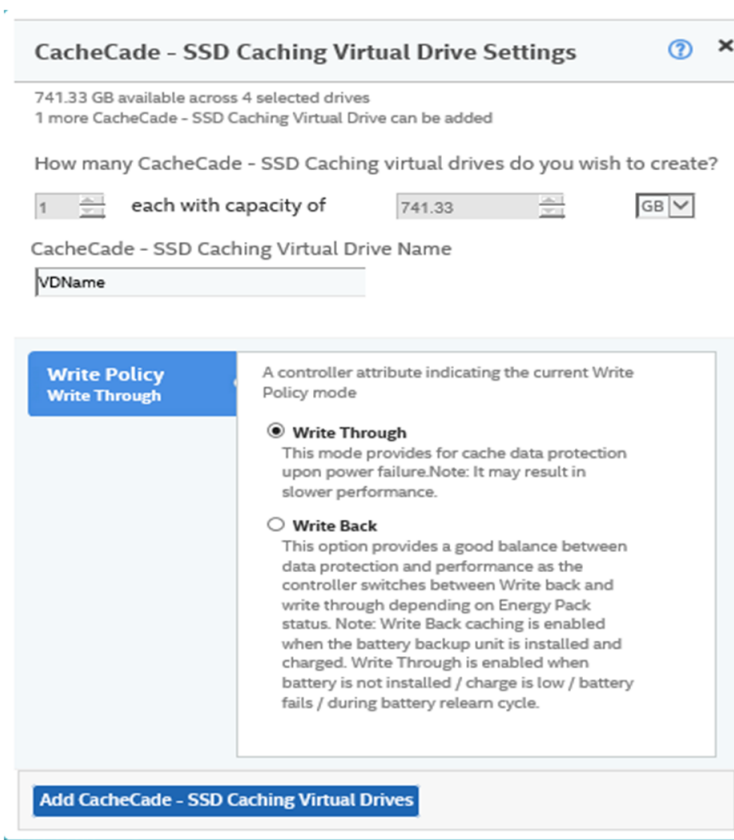
Figure 59: CacheCade – SSD Caching Virtual Drive Settings Window**NOTE**

You can create only one CacheCade – SSD Caching virtual drive because the full capacity of the virtual drive is used for the creation of a CacheCade – SSD Caching virtual drive.

9. Enter a name for the CacheCade – SSD Caching virtual drive in the **CacheCade – SSD Caching Virtual Drive Name** field.

The virtual drive name can have a maximum of 15 characters.

10. Specify the write policy for the CacheCade – SSD Caching virtual drives.

The write policy depends on the status of the energy pack. If the energy pack is not present, is low, is failed, or is being charged, the current write policy switches to write through.

The options follow:

- **Write Through**
- **Write Back**

11. Click **Add CacheCade – SSD Caching Virtual Drives**.

The newly created CacheCade – SSD Caching virtual drives appears in the **CacheCade – SSD Caching Configuration** window just below the **Add CacheCade – SSD Caching Virtual Drives** section.

If you want to modify the CacheCade – SSD Caching virtual drives settings before finishing the configuration, click the



icon.

12. Click **Finish**.

A message appears stating that the configuration is complete.

Modifying the CacheCade Virtual Drive Properties

You can modify the name and the write policy of a CacheCade – SSD Caching virtual drive any time after a CacheCade – SSD Caching virtual drive is created. Perform the following steps to change the virtual drive properties:

1. Navigate to the Controller dashboard and click a drive group name (for example, **DG_1**).

Click the  icon corresponding to a drive group to display its contents.

The virtual drives and physical drives associated with the selected drive group appear.

2. Click a CacheCade – SSD Caching virtual drive whose settings you want to change.
3. Select **Actions > More Actions > Modify Properties**.

The **Modify CacheCade – SSD Caching Virtual Drive: <Virtual Drive Name> Properties** dialog appears.

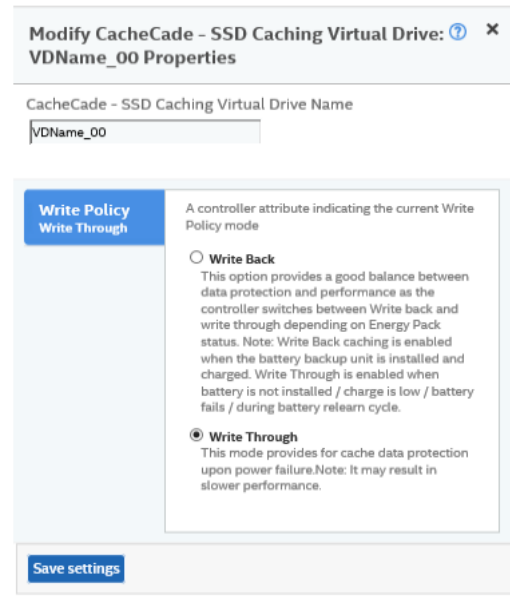
Figure 60: Modify CacheCade - SSD Caching Virtual Drive: VD_Name Properties Dialog

4. Change the **Virtual Drive Name** and the **Write Policy** properties as needed.
5. Click **Save Settings**.

Enabling SSD Caching on a Virtual Drive

You can enable SSD caching on a virtual drive. When you enable SSD caching on a virtual drive, that virtual drive becomes associated with an existing or with a future CacheCade – SSD Caching virtual drive. This option is only available when the virtual drive's caching is currently disabled.

1. Navigate to the Controller dashboard, and click a drive group name (for example, **DG_1**).
Click the  icon corresponding to a drive group to display its contents.
The virtual drives and physical drives associated with the selected drive group appear.
2. Click the virtual drive on which you want to enable SSD caching.
3. Select **Actions > Enable SSD Caching**.
The following popup appears.

Figure 61: Enable SSD Caching Popup

4. Click **Yes**.
A confirmation message appears.

Disabling SSD Caching on a Virtual Drive

You can disable caching on a virtual drive. When you disable SSD caching on a virtual drive, any associations that the selected virtual drive has with a CacheCade – SSD Caching virtual drive is removed. This option is only available when the virtual drive's caching is currently enabled.

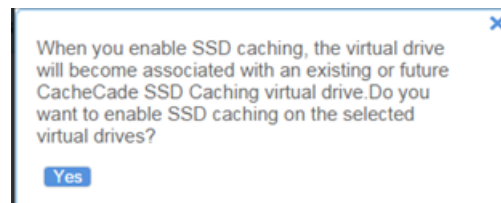
1. Navigate to the Controller dashboard, and click a drive group name (for example, **DG_1**).

Click the  icon corresponding to a drive group to display its contents.

The virtual drives and physical drives associated with the selected drive group appear.

2. Click the virtual drive on which you want to disable SSD caching.

3. Select **Actions > Disable SSD Caching**.

The following popup appears.

Figure 62: Disable SSD Caching Popup

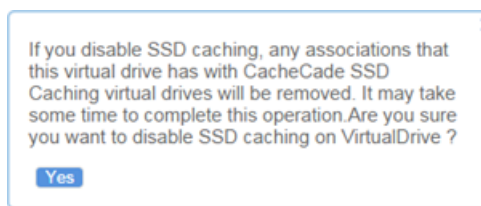

4. Click **Yes**.

A confirmation message appears.

Clearing Configuration on Controllers that Have CacheCade Virtual Drives

You can clear all existing configurations on a selected controller that has CacheCade Pro 2.0 virtual drives.

1. Navigate to the Controller dashboard whose configurations you want to clear.

2. Click **Configure**, then click **Clear Configuration**.

The following confirmation message appears.

Figure 63: Clear Configuration – CacheCade – SSD Caching

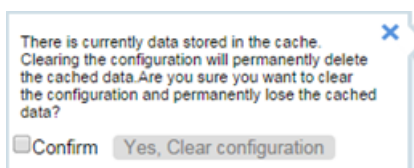

3. Select the **Confirm** check box and click **Yes, Clear configuration** to clear all the existing configurations on the controller.

However, the operating system drives cannot be cleared.

Deleting a CacheCade – SSD Caching Virtual Drive

Perform the following steps to delete a CacheCade – SSD Caching virtual drive.

1. Navigate to the controller dashboard, and click a drive group name (for example, **DG_1**).

Click the  icon corresponding to a drive group to display its contents.

The virtual drives and physical drives associated with the selected drive group appear.

2. Click the CacheCade – SSD Caching virtual drive that you want to delete.
3. Select **Actions > Delete**.

The following confirmation message appears.

Figure 64: CacheCade – SSD Caching Virtual Drive - Delete Confirmation

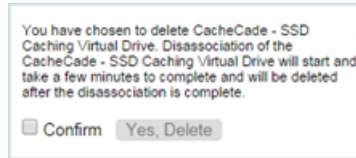

4. Select **Confirm** and click **Yes, Delete** to proceed with the delete operation.
A message appears confirming that the CacheCade – SSD Caching virtual drive is deleted successfully.

FastPath Advanced Software

The FastPath software is a high-performance I/O accelerator for SSD arrays connected to a MegaRAID controller card. This advanced software is an optimized version of Broadcom MegaRAID technology, particularly those that demonstrate high random read/write operation workloads, when deployed with a Broadcom MegaRAID SATA+SAS controller connected to SSDs.

SafeStore Encryption Services

The SafeStore software, together with self-encrypting drives (SEDs), secures a drive's data from unauthorized access or modification resulting from theft, loss, or repurposing of drives. If you remove an SED drive from its storage system or the server in which it resides, the data on that drive is encrypted, and it becomes useless to anyone who attempts to access it without the appropriate security authorization.

Auto Lock with Local Key Management locks the SED using an authentication key. When secured in this manner, the drive's data encryption key is locked whenever the drive is powered down. In other words, the moment the SED is switched off or unplugged, it automatically locks down the drive's data. When the drive is powered back on, it requires authentication before being able to unlock its encryption key and read any data on the drive. This action protects against any type of insider or external theft of drives or systems.

The Instant Secure Erase feature allows you to instantly and securely render data on SED drives unreadable, saving businesses time and money by simplifying the decommissioning of drives and preserving hardware value for returns and repurposing.

You can enable, change, and disable the drive security feature. You can also import a foreign configuration using the SafeStore Encryption Services advanced software.

Enabling Security

Ensure that MFC settings related to security are enabled in the firmware.

Perform the following steps to enable security on the drives.

1. In the controller dashboard, select **More Actions > Enable Security**.

The **Enable Security** dialog appears.

Figure 65: Enable Security Dialog

← Go back to Drive Group, Drives and Other Hardware list

Enable Security [?](#)

Controller ID: 0 Product Name 0x500062b200000000
Enabling security on this controller will have the option to create secure virtual drives using a security key.

Choose the security key management mode:
Local Key Management(LKM) ▼

Security Key Identifier: --Security Key Identifier-----
Specify a security key identifier.The controller has provided a default identifier for you. You may use this string or a new identifier.
If you have multiple security keys, the identifier will help you determine which security key to enter.

Suggest Security Key
Security Key: --Security Key-----
The security key will be used to lock each self-encrypted drive attached to the controller.
For maximum security, user 32 varied characters, you may optionally choose for the system to suggest a strong security key.
Note:
The security key is case-sensitive and must be between 8 and 32 characters, contain atleast 1 number, 1 lowercase letter 1 uppercase letter and 1 non-alphanumeric character(e.g. >?@)

Show Key
 Pause for Passphrase
 Enforce strong password security
Password: --Password-----
Optionally, You may enter a password to provide additional security. If you choose "Pause for password at boot time", you must enterit whenever you boot the server.
Note:
The password is case sensitive and must be between 8 and 256 characters.
If enforce strong password security is selected, then password field should contain atleast 1 number, 1 lowercase letter,1 uppercase letter and 1 non-alphanumeric character(e.g. >?@)

Confirm:

Show Password

Are you sure you want to enable security?
 Confirm

More Actions:

- Show Events
- ← More Actions
- Schedule Consistency Check (Starts on Monday : 12 AM)
- Set Consistency Check Properties
- Schedule Patrol Read (Starts on Wednesday : 5 PM)
- Start Patrol Read
- Advanced Software Options
- Set Adjustable Task Rate
- Disable SSD Guard
- Enable SCSI Unmap
- Download RTT Dump
- ← Snap Dump Actions
- Enable Security
- Manage Power Save Setting

- Select the **Local Key Management (LKM)** option from the **Choose the security key management mode** drop-down list.

To enable drive security, the following details must be specified:

- Security Key Identifier** – The controller, by default, assigns a security key identifier.
- Security Key** – Provides you with an option to create secure virtual drives by specifying the security key.
- Suggest Security Key** – Alternatively, you can click this option to have the system create a security key for you.
- Password** – You can also specify a password to provide additional drive security.
- Pause for password at boot time** and **Enforce strong password security** – If you select the **Pause for password at boot time**, you are prompted to provide the password each time you restart your server. If you select **Enforce strong password security**, the system enforces you to specify a strong password.
- Show Key** and **Show Password** – You can either select or clear the **Show Key** and **Show Password** check boxes. By default, they are not selected.

To enable drive security, perform the following steps:

- Either use the default security key identifier provided by the controller or specify a new security key identifier.

NOTE

If you create more than one security key, ensure that you change the security key identifier. Otherwise, you cannot differentiate between the security keys.

4. Either click **Suggest Security Key** to have the system create a security key for you, or enter a new security key in the **Security Key** field and confirm.
5. (Optional) Select the **Show Key** check box.

If you choose this option, the security key that you specify, or the security key that is created by the system if you have clicked **Suggest Security Key**, will be visible to you. If you do not select this option, the security key will not be visible to you.

IMPORTANT

Ensure that you write down this security key for future reference. If you are unable to provide the security key when it is required by the system, you will lose access to your data.

The security key is case-sensitive. It must be between 8 and 32 characters and contain at least one number, one lowercase letter, one uppercase letter, and one nonalphanumeric character (for example, < > @ +). The space character is not permitted.

Non-U.S. keyboard users must be careful not to enter double-byte character set (DBCS) characters in the security key field. The firmware works with the ASCII character set only.

6. (Optional) Select the **Pause for password at boot time** check box.
If you choose this option, you are prompted to provide the password each time you restart your server.
7. (Optional) Select the **Enforce strong password security** check box.
If you choose this option, make sure the password is between 8 and 32 characters and contain at least one number, one lowercase letter, one uppercase letter, and one non-alphanumeric character (for example, < > @ +). The space character is not permitted. The password is case-sensitive.
8. (Optional) Enter a password in the **Password** field and confirm the same password once again in the **Confirm** field.
9. (Optional) Select the **Show Password** check box.
If you choose this option, the password that you specify will be visible to you. If you do not select this option, the password will not be visible to you.
Warning messages appear if there is a mismatch between the characters entered in the **Password** field and the **Confirm** field, or if you have entered an invalid character.

IMPORTANT

Ensure you write down the password for future reference. If you are unable to provide the password when it is required by the system, you will lose access to your data.

10. Select the **Confirm** check box, and then click **Enable Security** to confirm that you want to enable drive security on this controller.

Changing Security Settings

NOTE

Drive security settings cannot be changed when EKM is enabled. Changes to drive security settings for EKM will fail from LSA.

When EKMS is enabled from another application, LSA:

- Does not allow security settings to be disabled or changed.
- Does not support changes to EKM or ESKM.
- Allows users to create secured VD.
- Allows users to secure PD.

Perform the following steps to change the encryption settings for the security key identifier, security key, and password.

1. In the Controller dashboard, select **More Actions > Change Security**.

The **Change Security** dialog appears.

Figure 66: Change Security Dialog

The screenshot shows the 'Change Security' dialog box. At the top, it says 'Controller ID: 0 Product Name 0x500062b200000000' and 'Enabling security on this controller will have the option to create secure virtual drives using a security key.' Below this, there are two radio buttons: 'Change current security settings' (selected) and 'Switch to External Key Management(EKM) mode (EKM is currently not supported by LSA)'. Under 'Change current security settings', there are three main sections: 'Use the existing security key identifier' (selected), 'Enter a new security key identifier', and 'Use the existing drive security key' (selected). The 'Use the existing security key identifier' section has a text field with 'RAID_805e00014_6077fc11' and a note: 'Specify a security key identifier. The controller has provided a default identifier for you. You may use this string or enter your own identifier. If you have multiple security keys, the identifier will help you determine which security key to enter.' The 'Use the existing drive security key' section has a 'Suggest Security Key' button and a 'Security Key' text field. Below it are 'Confirm', 'Show Key', 'Pause for Passphrase', and 'Enforce strong password security' options. The 'Password' section has a 'Password' text field, 'Confirm', and 'Show Password' options. At the bottom, there is a confirmation question: 'Are you sure you want to change the current security settings?' with 'Confirm' and 'Change Security' buttons. On the right side of the dashboard, a 'More Actions' menu is open, showing options like 'Schedule Consistency Check', 'Set Consistency Check Properties', 'Schedule Patrol Read', 'Start Patrol Read', 'Advanced Software Options', 'Set Adjustable Task Rate', 'Disable SSD Guard', 'Enable SCSI Unmap', 'Download RTT Dump', 'Snap Dump Actions', 'Disable Security', 'Change Security', and 'Manage Power Save Setting'.

2. Select the **Change current security settings** radio button from the **Current drive security mode is FW** field. When LKMS is enabled, LSA will show the current drive security mode as FW instead of LKM.
3. Either you can use the existing security key identifier assigned by the controller, or you can specify a new security key identifier. If you change the security key, you need to change the security key identifier. Otherwise, you cannot differentiate between the security keys.
4. Either select the **Use the existing security key** option or select the **Enter a new drive security key** to specify a new security key and confirm once again.
5. Either click **Suggest Security Key** to have the system create a security key, or you can enter a new security key in the **Security Key** text field.
6. (Optional) Select the **Show Key** check box.

NOTE

The security key is case-sensitive. It must be between 8 and 32 characters and contain at least one number, one lowercase letter, one uppercase letter, and one non-alphanumeric character (for example, < > @ +).

7. (Optional) Select the **Pause for password** at boot time check box. If you choose this option, you are prompted to provide the password each time you restart your server.

8. (Optional) Select the **Enforce strong password security** check box.
If you choose this option, make sure the password is between 8 and 32 characters and contain at least one number, one lowercase letter, one uppercase letter, and one non-alphanumeric character (for example, < > @ +). The space character is not permitted. The password is case-sensitive.
9. If you chose to use a password, either enter the existing password or enter a new password, and confirm once again.
10. (Optional) Select the **Show Password** check box.
If you choose this option, the password that you specify will be visible to you. If you do not select this option, the password will not be visible to you.
11. Select the **Confirm** check box and click **Change Security** to change the security settings.
The **Authenticate Drive Security Settings** dialog appears. Your authentication is required for the changes to take effect. Enter the new security key that you just specified in the **Security Key** field.
12. Enter the new security key that you just specified and click **Authenticate** to authenticate the changes.
The existing configuration on the controller is updated to use the new security settings.

Disabling Security

ATTENTION

If you disable security, your existing data is not secure and you cannot create any new secure virtual drives. Disabling security does not affect the security of data on foreign drives. If you have removed any drives that were previously secured, you still need to enter the password when you import them. Otherwise, you cannot access the data on those drives. If there are any secure drive groups on the controller, you cannot disable security. A warning dialog appears if you attempt to do so. To disable security, you must first delete the virtual drives on all of the secure drive groups.

Perform the following steps to disable drive security:

1. In the Controller dashboard, select **More Actions > Disable Security**.
A warning message appears asking for your confirmation.
2. Select **Confirm** and click **Yes, Disable Security**.
The software disables drive security.

Importing or Clearing a Foreign Configuration – Security-Enabled Drives

Perform the following steps to import or clear foreign configuration for security-enabled drives.

1. Enable drive security to allow importation of security-enabled foreign drives.
2. After you create a security key, navigate to the Controller dashboard, and click **Configure**, then click **Foreign Configuration**.
If locked drives (security is enabled) exist, the **Unlock Foreign Drives** dialog appears.
3. Enter the security key to unlock the configuration.
The **Foreign Configuration** window appears, which lists all of the foreign configurations.
4. Click one of the following options:
 - **Import**: Import the foreign configuration from all the foreign drives.
 - **Clear**: Remove the configuration from all the foreign drives.
5. Click **Re-Scan** to refresh the window.
6. Repeat the import process for any remaining drives because locked drives can use different security key, and you must verify whether there are any remaining drives to be imported.

Managing Drive Groups

The LSI Storage Authority software lets you monitor the status of the drive groups and spanned drive groups.

- [Viewing Drive Group Properties](#)
- [Adding a Virtual Drive to a Drive Group](#)
- [RAID Level Migration](#)

Viewing Drive Group Properties

Select a drive group in the Controller dashboard to view its properties.

The following figure and table describe the drive group properties.

Figure 67: Drive Group Properties Window

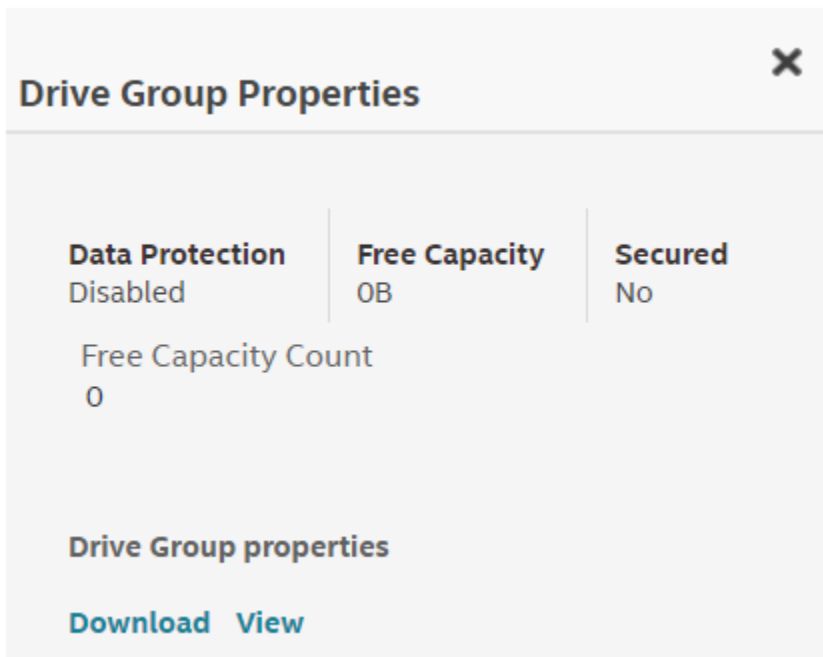



Table 11: Drive Group Properties

Property	Description
Data Protection	Indicates if data protection is enable or disabled.
Free Capacity	Indicates the free space available in the drive group.
Secured	Indicates whether the drive group is secured.
Free Capacity Count	Displays the number of free holes present on the drive group.

If you have selected multiple virtual drives or multiple physical drives, you must click the  (Expand button) to perform actions, such as starting a consistency check. This step is applicable for all scenarios where you have selected multiple virtual drives or multiple physical drives and performed certain actions through the **Actions** dialog.

Adding a Virtual Drive to a Drive Group

You can add virtual drives to an existing drive group provided sufficient storage space exists in the current virtual drives of the drive group.

Perform the following steps to add a virtual drive to an existing drive group:

1. Navigate to the Controller dashboard, and click a drive group name (for example, **DG_1**).
In the right pane, under **Actions**, the **Add Virtual Drives** option appears.
2. Click **Add Virtual Drives**.
The **Virtual Drive Settings** window appears.
3. Specify the settings you want for the virtual drives you want to create.
See [Adding Virtual Drives](#) for details on creating virtual drives.
4. Click **Add Virtual Drives**.
The newly created virtual drive gets added to the selected drive group.
5. (Optional) If the drive group was created using a secure virtual drive, select **Element(s) Actions > Secure** to secure the drive.

Figure 68: Secure Dialog

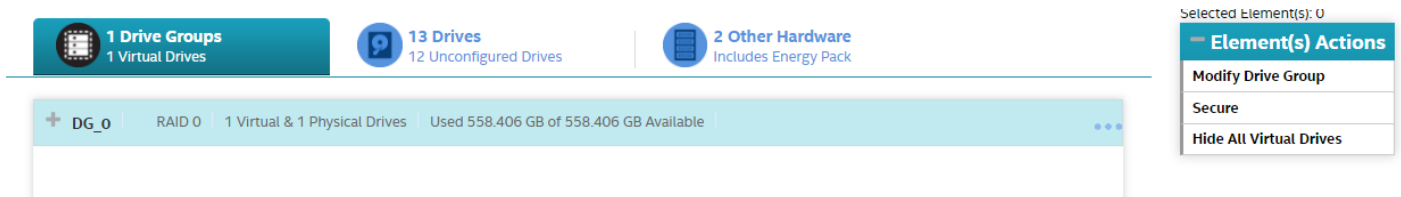

RAID Level Migration

RAID level migration is the process of converting one RAID configuration to another. You can perform RAID level migration at the drive group level. The following table describes the valid RAID level migration matrix.

Table 12: Drive Group – RAID Level Migration

Initial RAID Level	Migrated RAID Level
RAID 0	RAID 1
RAID 0	RAID 5
RAID 0	RAID 6
RAID 1	RAID 0
RAID 1	RAID 5
RAID 1	RAID 6
RAID 5	RAID 0
RAID 5	RAID 6
RAID 6	RAID 0
RAID 6	RAID 5

Migrating the RAID Level of a Drive Group

Perform the following steps to migrate the RAID level of a drive group.

1. Navigate to the Controller dashboard, and click a drive group name (for example, **DG_1**).
In the right pane, under **Actions**, the **Modify Drive Group** option appears.
2. Click **Modify Drive Group**.
The **Modify Drive Group** window appears.

Figure 69: Modify Drive Group Window

3. In the **RAID Level Setting** drop-down menu, select the RAID level to which you want to migrate the drive group.
Backup the data before you change the RAID levels.
 - Select the **Auto Back-up** check box to back up the data before you change the RAID level.
4. Click **Next**.
The **Modify Drive Group** window appears and provides you an option to add, remove, or directly change the RAID level. Depending on the source and the target RAID levels, you can also add drives directly without choosing an option.

Adding Physical Drives to a Configuration

For example, if you want to migrate the RAID level of a drive group from RAID 0 to RAID 5, the **Modify Drive Group** wizard lets you add unconfigured physical drives to the existing configuration to enable the RAID level migration.

1. In the **Modify Drive Group** window, click **Add Physical Drives**.

The drives you add must have the same capacity as, or greater capacity than, the drives already in the drive group, or you cannot change the RAID level.

The **Available Unconfigured Drive** window appears. It lists the drives you can add, and states whether you must add a minimum number of drives to change the RAID level from the current level to the new RAID level.

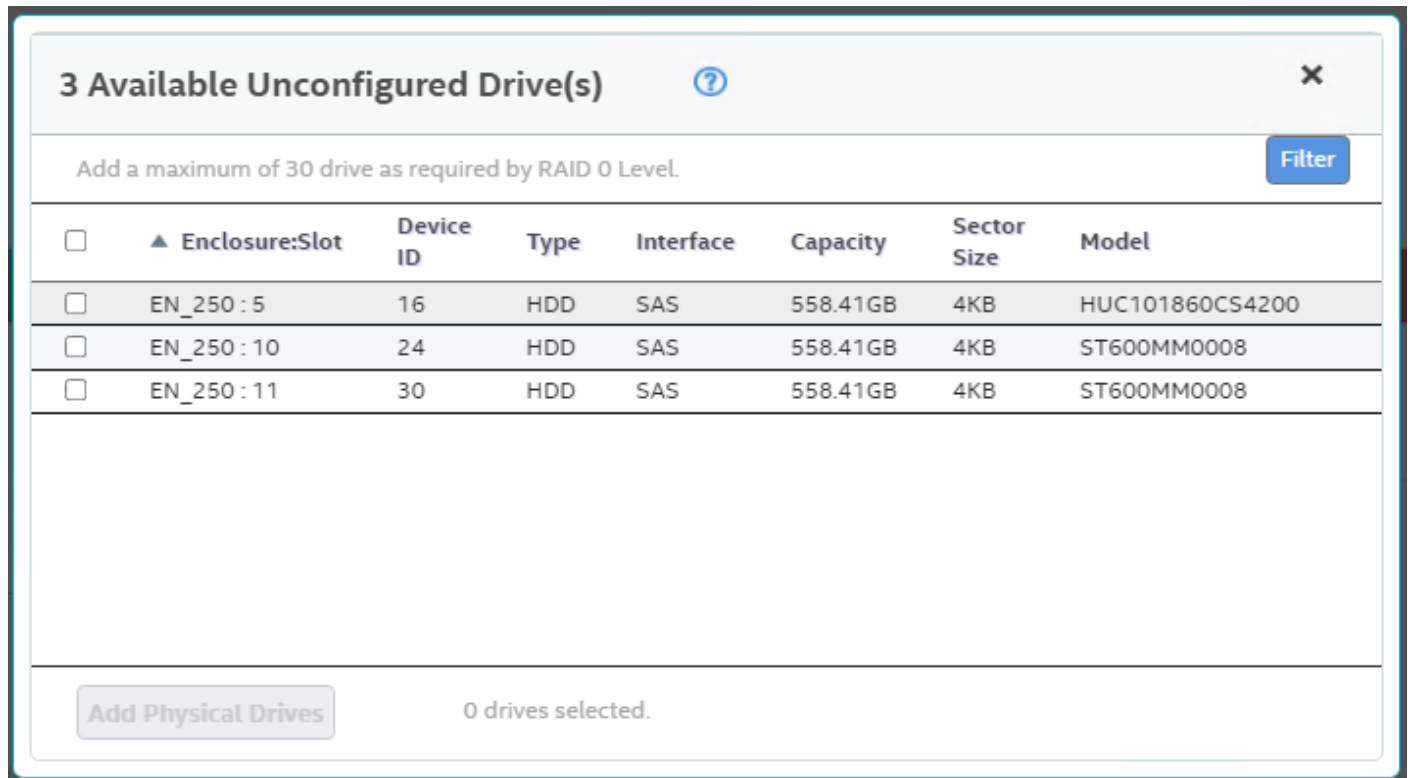
Figure 70: Available Unconfigured Drive Window

2. Select the available unconfigured drives, and click **Add Physical Drives**.

3. Click **Finish**.

The RAID level is migrated. A confirmation message appears. You can monitor the progress of the reconstruction. See [Background Operations Support](#).

Removing Drives from a Configuration

For example, if you migrate the RAID level of a drive group from RAID 5 to RAID 0, the **Modify Drive Group** wizard lets you remove physical drives from the existing configuration to enable the RAID level migration.

1. In the **Modify Drive Group** window, select **Remove drives** and click **Next**.

The **Modify Drive Group** window appears, and it states the number of physical drives that you must remove to change the RAID level from the current level to a new RAID level and the maximum number of physical drives that can be removed.

2. Click the **X** icon to remove the drives.

3. Click **Finish**.

The RAID level is migrated. A confirmation message appears. You can monitor the progress of the reconstruction. See [Background Operations Support](#).

Migrating the RAID Level without Adding or Removing Drives

For example, if you migrate the RAID level of your drive group from RAID 5 to RAID 0, the **Modify Drive Group** wizard lets you migrate the RAID level without adding or removing the drives.

1. In the **Modify Drive Group** window, select **Migrate RAID level**.
2. Click **Next**.

The RAID level is migrated. A confirmation message appears. You can monitor the progress of the reconstruction. See [Background Operations Support](#).

Managing Virtual Drives

The LSI Storage Authority software lets you perform various operations on the virtual drives.

- [Viewing Virtual Drive Properties](#)
- [Modifying Virtual Drive Properties](#)
- [Start and Stop Locating a Virtual Drive](#)
- [Erasing a Virtual Drive](#)
- [Initializing a Virtual Drive](#)
- [Starting Consistency Check on a Virtual Drive](#)
- [Expanding the Online Capacity of a Virtual Drive](#)
- [Deleting a Virtual Drive](#)
- [Behavior of Virtual Drive Operations on VMware](#)
- [Hiding and Unhiding a Virtual Drive or a Drive Group](#)

Viewing Virtual Drive Properties

Select a virtual drive from a drive group in the Controller dashboard to view its properties.

Figure 71: Virtual Drive Properties Window

The screenshot shows a window titled "Virtual Drive Properties" with a close button (X) in the top right corner. The window displays a grid of properties for a virtual drive. At the bottom, there are links for "Download" and "View".

Virtual Drive Properties			
State Optimal	Current Read Cache Status No Read Ahead	Default Read Cache Policy No Read Ahead	Current Write Cache Status Write Back
Default Write Cache Policy Write Back	Current IO Status Direct IO	Default IO Policy Direct IO	Access Policy Read Write
Drive Cache Policy Disabled	Data Protection Disabled	Current Unmap Status Disabled	

Virtual Drive properties

[Download](#) [View](#)

Table 13: Virtual Drive Properties

Property	Description
State	The current status of the virtual drive. These options are available: <ul style="list-style-type: none"> • Optimal • Partially Degraded • Degraded • Offline
Current Read Cache Status	The read cache policy for the virtual drive. These options are available: <ul style="list-style-type: none"> • No Read Ahead
Default Read Cache Policy	<ul style="list-style-type: none"> • Read Ahead • No Read Ahead
Current Write Cache Status	The write cache policy for the virtual drive. These are available: <ul style="list-style-type: none"> • Write Back • Write Through • Always Write Back
Default Write Cache Policy	<ul style="list-style-type: none"> • Default • Enabled • Disabled
Current IO Status	The current IO policy for the virtual drive.
Default IO Policy	<ul style="list-style-type: none"> • Direct IO • Cached IO
Access Policy	The access policy for the virtual drive. These options are available: <ul style="list-style-type: none"> • Read Write • Read Only • Hidden <p>The Hidden policy is applicable for only hidden virtual drives. No other access policies are applicable after you select Hidden as the access policy.</p>
Drive Cache Policy	The virtual drive cache setting. These options are available: <ul style="list-style-type: none"> • Unchanged • Enabled • Disabled
Data Protection	Indicates if data protection is enabled or disabled.
Current Unmap Status	The current status of Unmap.

Modifying Virtual Drive Properties

You can change the read policy, write policy, and other virtual drive properties at any time after a virtual drive is created. Perform the following steps to modify the virtual drive settings.

1. Navigate to the Controller dashboard, and click a drive group name (for example, **DG_1**).

Click the  icon corresponding to a drive group to display its contents.

The virtual drives and physical drives associated with the selected drive group appear.

- Click the virtual drive whose settings you want to change.
- Select **Actions > Modify Properties**.

The **Modify Virtual Drive Properties** dialog appears.

Figure 72: Modify Virtual Drive Properties Dialog

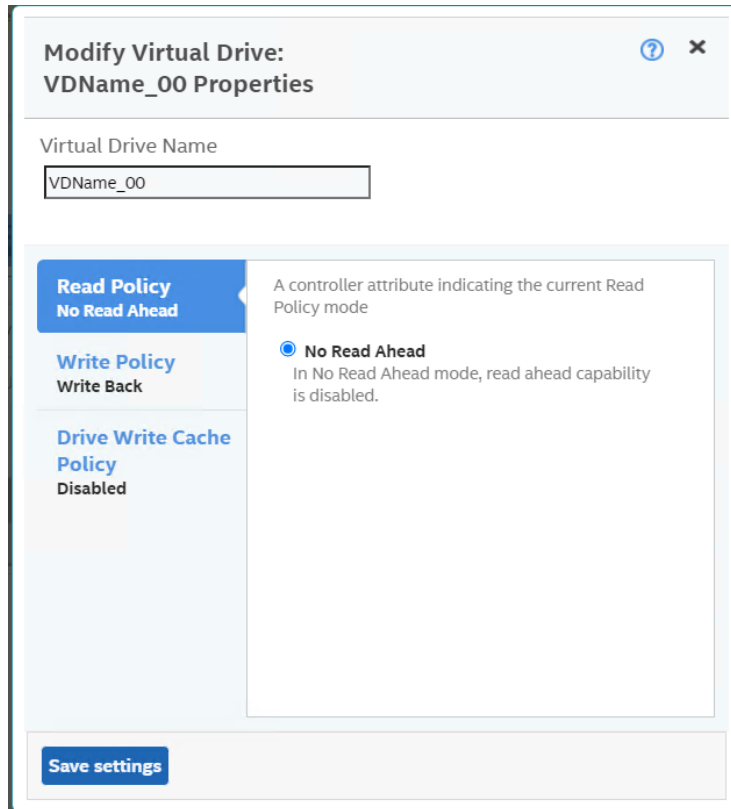

- Change the virtual drive properties as needed.
For information about these properties, see [Adding Virtual Drives](#).
- Click **Save settings**.

Start and Stop Locating a Virtual Drive

If the drives in the virtual drives reside in a disk enclosure, you can identify them by making their LEDs blink. Perform the following steps to identify the virtual drives:

- Navigate to the Controller dashboard, and click a drive group name (for example, **DG_1**).
Click the  icon corresponding to a drive group to display its contents.
The virtual drives and physical drives associated with the selected drive group appear.
- Click the virtual drive that you want to locate in the disk enclosure.
- Select **Actions > Start Locate**.
The LEDs on the drives in the virtual drive start blinking.

4. Select **Actions > Stop Locate** to stop the LEDs from blinking.

Erasing a Virtual Drive

The virtual drive erase function operates on a specified virtual drive and overwrites all user-accessible locations. It supports nonzero patterns and multiple passes. The virtual drive erase function optionally deletes the virtual drive and erases the data within the virtual drive's LBA range. The virtual drive erase function is a background operation, and it posts events to notify users of the progress.

Perform the following steps to erase a virtual drive.

1. Navigate to the Controller dashboard, click a drive group name (for example, **DG_1**).

Click the  icon that corresponds to a drive group to display its contents.

The virtual drives and physical drives associated with the selected drive group appear.

2. Click the virtual drive whose content you want to erase.

3. Select **Element(s) Actions > Erase**.

The **Virtual Drive Erase** dialog appears.

Figure 73: Virtual Drive Erase Dialog

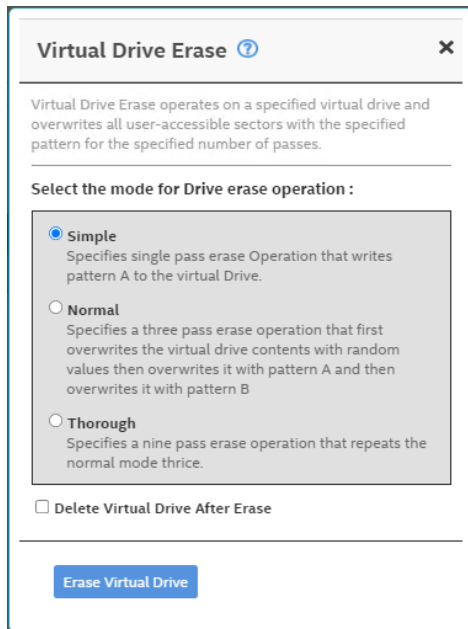

The dialog shows the following modes:

- **Simple**
- **Normal**
- **Thorough**

4. Select the **Delete Virtual Drive After Erase** check box to delete the virtual drive after the erase operation has been completed.

5. Select a mode and click **Erase Virtual Drive**.

A warning message appears asking for your confirmation.

6. Click **Yes, Erase Drive**.

After the virtual drive erase operation has started, the **Stop Erase** option is enabled in the **Element(s) Actions** menu. You can monitor the progress of the erase operation. See [Background Operations Support](#).

Initializing a Virtual Drive

When you create a new virtual drive using the **Advanced Configuration** wizard, you can select the **Fast Initialization** or **Full Initialization** option to initialize the drive immediately. However, you can select **No Initialization** if you want to initialize the virtual drive later.

Perform the following steps to initialize a virtual drive after completing the configuration process.

1. Navigate to the Controller dashboard, and click a drive group name (for example, **DG_1**).

Click the  icon that corresponds to a drive group to display its contents.

The virtual drives and physical drives associated with the selected drive group appear.

2. Click the virtual drive that you want to initialize.

3. Select **Actions > Start Initialize**.

A warning message appears.

NOTE

Initialization erases all data on the virtual drive. Be sure to back up any data you want to keep before you initialize a virtual drive. Ensure the operating system is *not* installed on the virtual drive you are initializing.

4. Select the **Fast Initialization** check box if you want to use this option.

If you leave the check box unselected, the software runs a full initialization on the virtual drive.

5. Click **Yes, Start Initialization** to begin the initialization.

You can monitor the progress of the initialization. See [Background Operations Support](#).

Starting Consistency Check on a Virtual Drive

Perform the following steps to start consistency check on a virtual drive. For more information about consistency check, see [Running a Consistency Check](#).

1. Navigate to the Controller dashboard, select a drive group name (for example, **DG_1**).

Click the  icon that corresponds to a drive group to display its contents.

The virtual drives and physical drives associated with the selected drive group appear.

2. Click the virtual drive on which you want to start consistency check.

3. Select **Actions > Start Consistency Check**.

The consistency check operation starts. You can see the progress of this operation in the **Background Processes in Progress** section. After the consistency check operation has started, the **Stop Consistency Check** option is enabled in the **Actions** menu.

Expanding the Online Capacity of a Virtual Drive

The Online Capacity Expansion (OCE) function lets you expand the capacity of a virtual disk by adding new physical disks or making use of unused space on existing disks, without requiring a reboot. Perform the following steps to expand the capacity of a virtual drive.

ATTENTION

Make sure to back up the data on the virtual drive before you proceed with the OCE.

1. Navigate to the Controller dashboard, select a drive group name (for example, **DG_1**) then click the  icon that corresponds to a drive group to display its contents.

The virtual drives and physical drives associated with the selected drive group appear.

2. Select the virtual drive whose capacity you want to expand.

3. Select **Element(s) Actions > Expand**.

The **Expand Virtual Drive** dialog appears.

Figure 74: Expand Virtual Drive Dialog 1

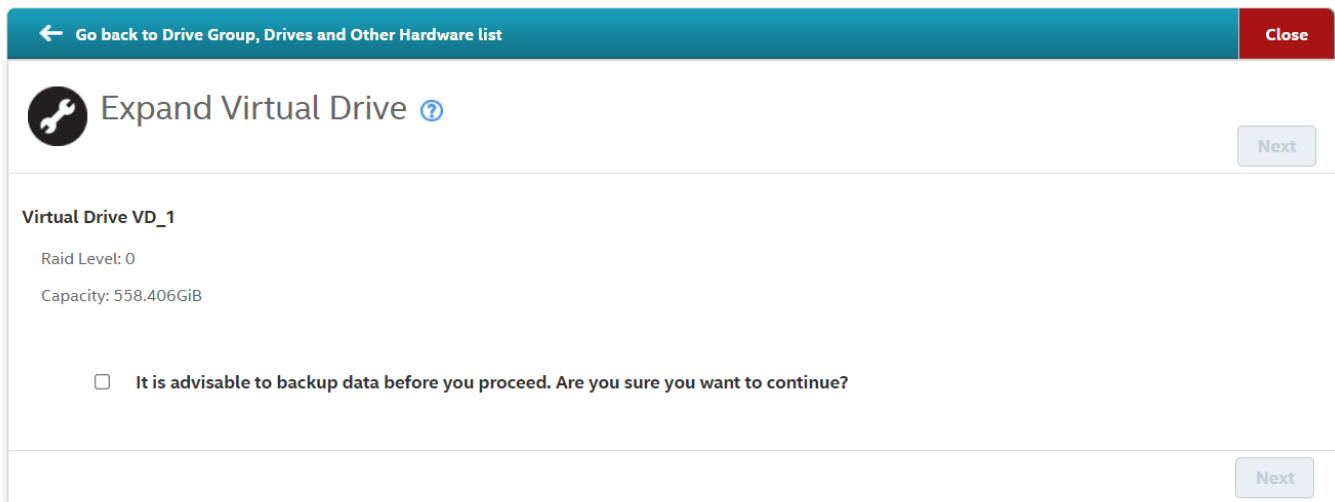

- Select the **It is advisable to backup data before you proceed. Are you sure you want to continue?** check box and click **Next**.
- Click **Add Physical Drives** and select an unconfigured drive.

Figure 75: Available Unconfigured Drive(s) Dialog

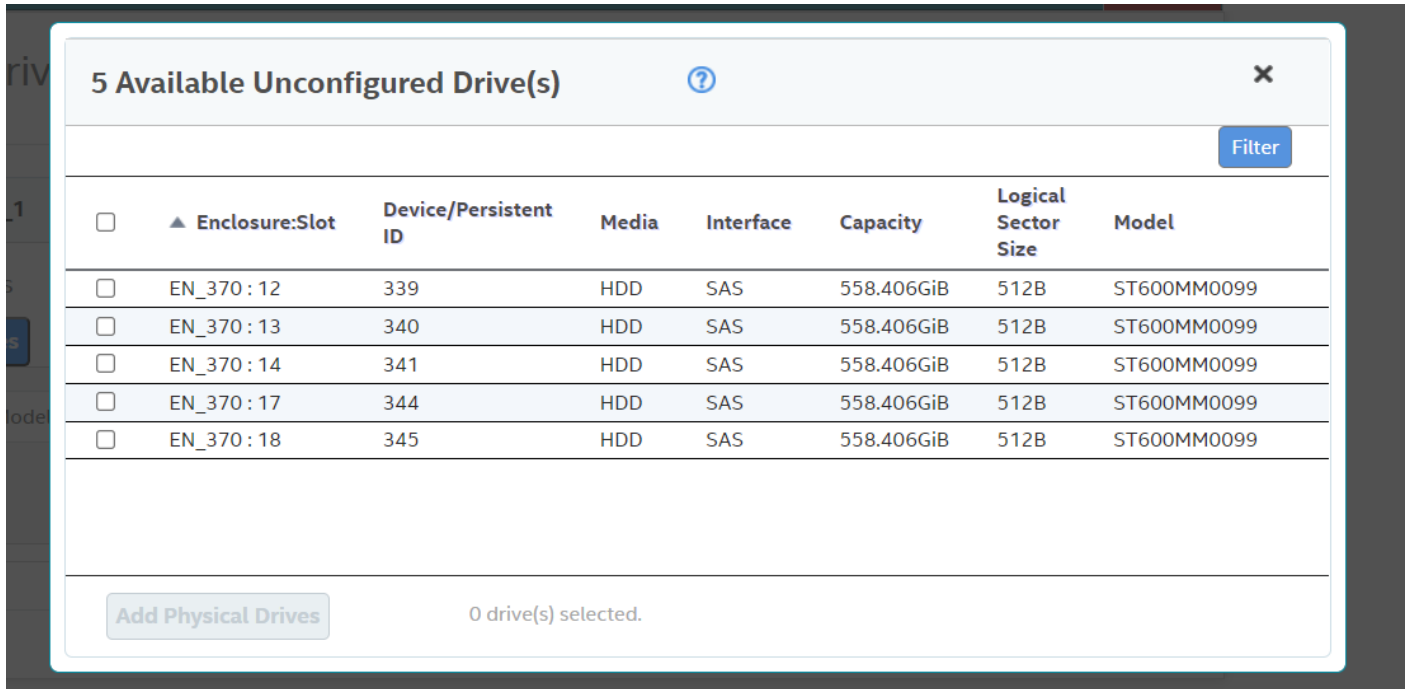

- Click **Finish**.

Figure 76: Expand Virtual Drive Dialog 2

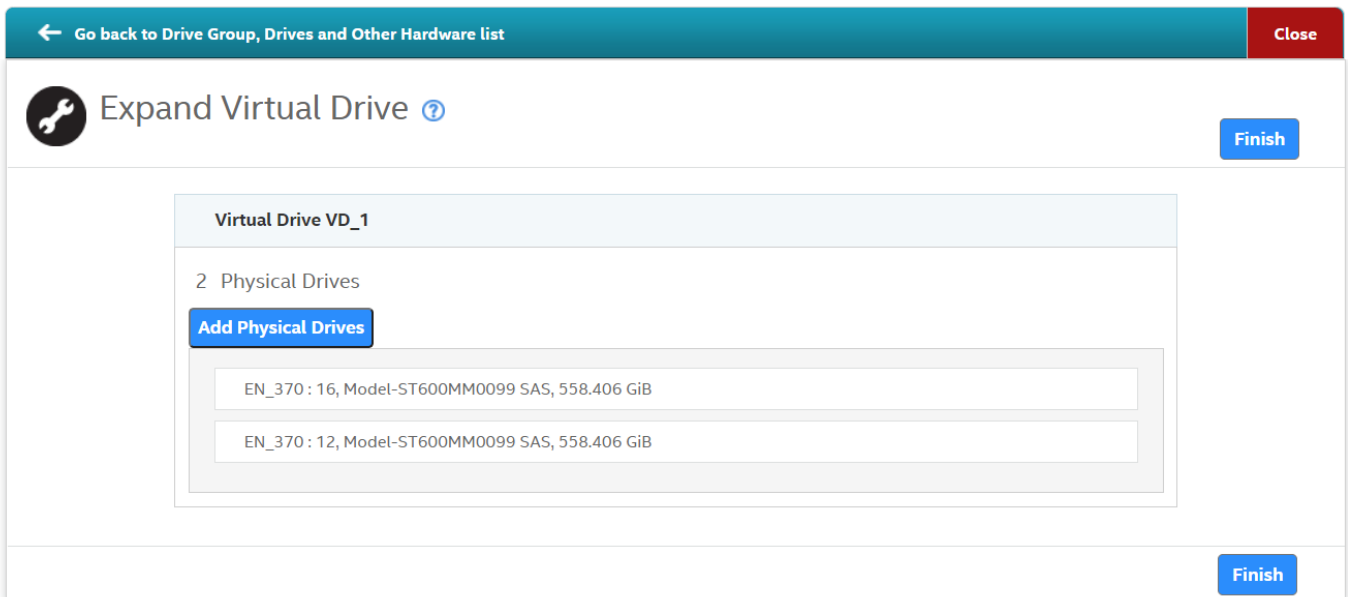

Deleting a Virtual Drive

You can delete virtual drives on a controller to reuse that space for new virtual drives.



CAUTION

All data on a virtual drive is lost when you delete the virtual drive. Make sure to back up the data before you delete a virtual drive.

Perform the following steps to delete a virtual drive.

1. Navigate to the Controller dashboard, click a drive group name (for example, **DG_1**).

Click the  icon that corresponds to a drive group to display its contents.

The virtual drives and physical drives associated with the selected drive group appear.

2. Click the virtual drive that you want to delete.

3. Select **Actions > Delete**.

A confirmation dialog appears.

4. Click **Confirm** and click **Yes, Delete** to proceed with the delete operation.

A message appears confirming that the virtual drive is deleted successfully.

NOTE

You cannot delete operating system drives. If you try to do so, an error message appears.

Behavior of Virtual Drive Operations on VMware

On the LSA client, when you select multiple virtual drives on which to perform operations such as Drive Initialization, Consistency Check, Drive Erase, and so on, the VMware ESXi Server might time out, resulting in a delay of the operation that is being performed.

Because the requested operations are process-intensive and take a long time to complete, the LSA GUI can transition into an idle state until either the requested operation completes or the VMware ESXi Server times out. During this state (idle state of LSA GUI), you cannot perform any other action on the LSA GUI.

While the LSA client is processing the requested operation in the background and is taking more than the usual time to complete, the LSA GUI transitions in to an idle state without letting you perform any other operation; you might assume that the LSA GUI has hung up because you cannot see what is happening in the background.

You can overcome this problem by enabling the **Schedule Panel** feature. The following are some of the advantages of enabling the Schedule Panel feature:

- When performing any process-intensive operations on multiple virtual drives such as Drive Initialization, Consistency Check, Drive Erase, and so on, a Schedule Panel screen is displayed, which shows the Target ID of the virtual drive and the status of the operation that is being performed.
- This Schedule Panel screen is updated on completion of each process, indicating whether the request is being processed or not, in a real time.
- The **Close** button is enabled on the Schedule Panel screen only when all the operations that are being performed are complete, allowing you to close the Schedule Panel screen only when the button is enabled.
- Until the operations are complete, you cannot perform any other action on the LSA GUI.

Enabling the Schedule Panel Feature

By default, the operating systems that run on the VMware ESXi OS are enabled with the **Schedule Panel** feature. However, if you are running Windows, Linux, or any other operating system, you can modify the parameters to enable this feature.

Perform the following steps to enable the **Schedule Panel** feature:

1. Browse to `C:\Program Files\LSI\LSIStorageAuthority\server\html\files`.
2. Open the `configfile.json` file.
3. Search for the `server` field in the `configfile.json` file.
4. Depending on the operating system you are using, change the value present in the `server` field to:
 - VMware ESXi Operating System – 0 .
 - Windows and Linux Operating Systems – 1 .
 - All other operating systems – 2 .

LWA is a stand-alone installation. To enable the **Schedule Panel** feature for the LWA server, change the value in the present `server` field to 1 or 2 .

Disabling the Schedule Panel Feature

By default, systems using the VMware ESXi OS are enabled with the **Schedule Panel** feature. However, you can also modify the parameters to disable this feature.

Perform the following steps to disable the **Schedule Panel** feature:

1. Browse to `C:\Program Files\LSI\LSIStorageAuthority\server\html\files`.
2. Open the `configfile.json` file.
3. Search for the `schedule` field in the `configfile.json` file.
4. Modify the value present in the `schedule` field to:
 - To disable the **Schedule Panel** feature – 0 .

Disabling this feature might result in the VMware ESXi server timing out if you have selected multiple virtual drives to perform process-intensive operations. See [Behavior of Virtual Drive Operations on VMware](#) for more information.

- To enable the **Schedule Panel** feature – 1 .

Modifying the Time Limit of the Schedule Panel

The **Close** button on the **Schedule Panel** screen is only enabled when all the operations that are being performed are complete; until the operations are complete, you cannot perform any other action on the LSA GUI. However, using this Time Limit feature, you can configure to close the **Schedule Panel** screen if operation did not complete within the expected time. The maximum wait time for each virtual drive operation to complete is set to four seconds by default.

Perform the following steps to modify the time limit of the Schedule Panel:

1. Browse to `C:\Program Files\LSI\LSIStorageAuthority\server\html\files`.
2. Open the `configfile.json` file.
3. Search for the `maxTime` field in the `configfile.json` file.
4. Modify the value present in the `maxTime` field according to your requirement.

By default, the `maxTime` value is set to 4000 milliseconds (four seconds) for each virtual drive operation.

5. Save your new settings before closing the `configfile.json` file.

Hiding and Unhiding a Virtual Drive or a Drive Group

You can hide or unhide either a virtual drive or a drive group on the controller.

NOTE

Hiding and unhiding a virtual drive or a drive group is not supported for SAS4xxx controllers.

- [Hiding a Virtual Drive](#)
- [Unhiding a Virtual Drive](#)
- [Hiding a Drive Group](#)
- [Unhiding a Drive Group](#)

Hiding a Virtual Drive

You can hide a virtual drive on the controller.

NOTE

Hiding a virtual drive is not supported for SAS4xxx controllers.

Perform the following steps to hide a virtual drive:

1. Navigate to the Controller dashboard, and click **Drive Groups** (for example, **DG_1**).
2. Click the  icon corresponding to a drive group to display its contents.
The virtual drives associated with the selected drive group appear.
3. Select a virtual drive that you want to hide.
4. Select **Actions > More Actions > Hide**.
A message box appears, which asks you to confirm the operation.
5. Click **Yes** to confirm and hide the virtual drive.

Unhiding a Virtual Drive

You can unhide a virtual drive on the controller.

NOTE

Unhiding a virtual drive is not supported for SAS4xxx controllers.

Perform the following steps to unhide a virtual drive:

1. Navigate to the Controller dashboard, and click **Drive Groups** (for example, **DG_1**).
2. Select the entire virtual drive group that you want to unhide.
3. Select **Actions > Un Hide**.
A message box appears, which asks you to confirm the operation.
4. Click **Yes** to unhide the virtual drive.

Hiding a Drive Group

You can hide a drive group on the controller.

If you hide a drive group, all of the virtual drives that are a part of this drive group become hidden.

NOTE

Hiding a drive group is not supported for SAS4xxx controllers.

Perform the following steps to hide a drive group:

1. Navigate to the Controller dashboard, and click **Drive Groups** (for example, **DG_1**).
2. Click the drive group that you want to hide.
3. Navigate to **Actions > Hide All Virtual Drives**.

A message box appears, which asks you to confirm the operation.

4. Select the **Confirm** check box and click **Yes** to hide the drive group.

Unhiding a Drive Group

You can unhide a drive group on the controller.

If you unhide a drive group, all of the virtual drives that are a part of this drive group become unhidden.

NOTE

Unhiding a drive group is not supported for SAS4xxx controllers.

Perform the following steps to unhide a drive group:

1. Navigate to the Controller dashboard, and click **Drive Groups** (for example, **DG_1**).
2. Click a drive group that you want to unhide.
3. Navigate to **Actions > Un Hide All Virtual Drives**.

A message box appears, which asks you to confirm the operation.

4. Select the **Confirm** check box and click **Yes** to unhide the drive group.

Managing Physical Drives

The LSI Storage Authority software lets you manage the physical drives that are connected to the controller.

- [Viewing Physical Drive Properties](#)
- [Viewing Volatile Properties](#)
- [Locating Tape Drives](#)
- [Start and Stop Locating a Drive](#)
- [Making a Drive Offline](#)
- [Making a Drive Online](#)
- [Replacing a Drive](#)
- [Marking a Drive as a Missing Drive](#)
- [Replacing a Missing Drive](#)
- [Viewing Protected Drive Groups](#)
- [Assigning Global Hot Spares](#)
- [Removing Global Hot Spares](#)
- [Assigning Dedicated Hot Spares](#)
- [Rebuilding a Drive](#)
- [Converting an Unconfigured Bad Drive to an Unconfigured Good Drive](#)
- [Removing a Drive](#)
- [Making Different Types of Drives](#)
- [Erasing a Drive](#)
- [Erasing a Drive Securely](#)
- [Sanitizing a Drive](#)

NOTE

To view the LUN details, click **NS/LU Count** of the physical drive in the physical drive table.

Viewing Physical Drive Properties

Select a physical drive from a drive group in the Controller dashboard to view its properties. The following figure and table describe the physical drive properties.

Figure 77: Physical Drive Properties Window

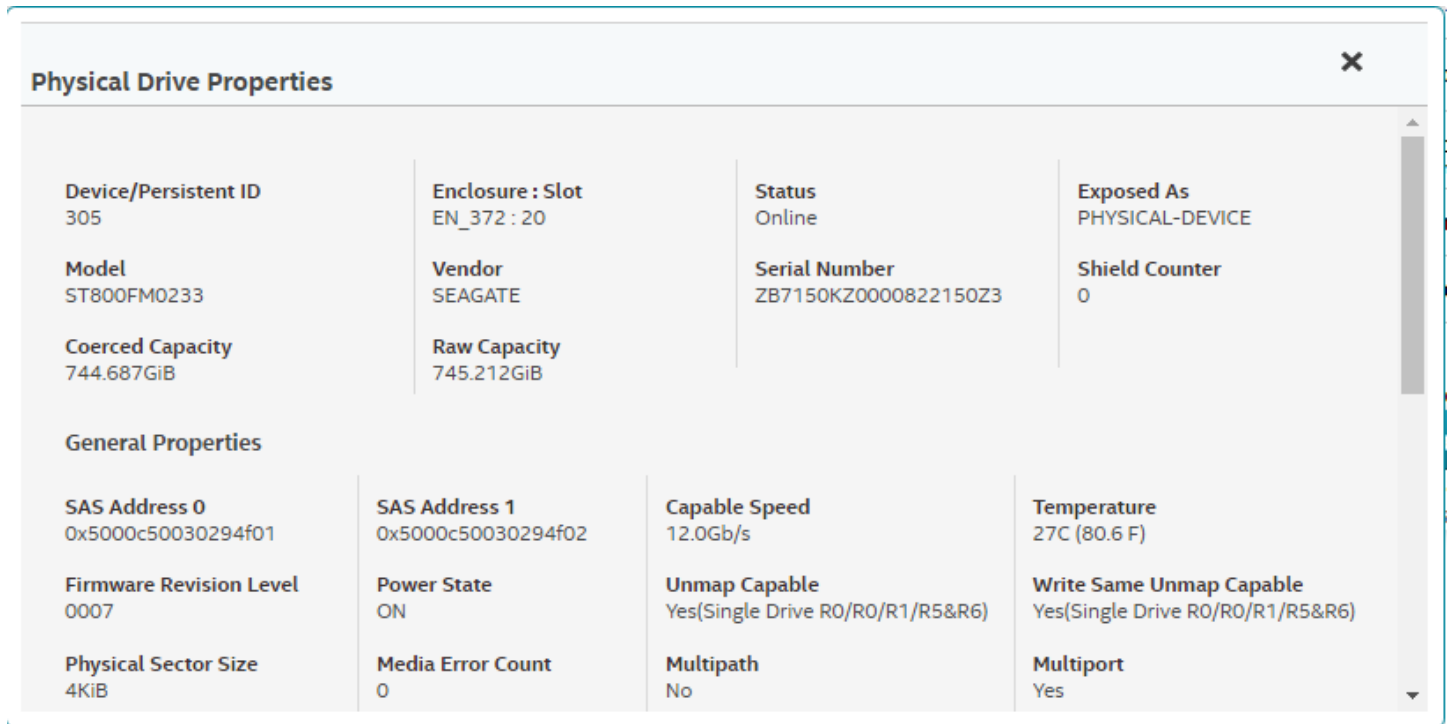

Table 14: Physical Drive Properties

Property	Description
Device/Persistent ID	The device ID of the physical drive that is assigned by the manufacturer.
Enclosure : Slot	The slot number of the enclosure in which the drive is connected.
Status	The current status of the physical drives.
Exposed As	To differentiate the physical drives, the drives are exposed as one of the following drive: <ul style="list-style-type: none"> • JBOD • PHYSICAL-DEVICE
Model	The model number of the physical drive.
Vendor	The vendor of the physical.
Serial Number	The serial number of the physical drive.
Shield Counter	The shield counter value.
Coerced Size	A drive property that indicates the capacity to which a drive has been coerced (forced) to make it compatible with other drives that are nominally the same capacity.
Raw Capacity	The actual full capacity of the drive before any coercion mode is applied to reduce the capacity.
General Properties	
SAS Address 0	The World Wide Name (WWN) for the physical drive.

Property	Description
Capable Speed	The maximum speed supported by the device.
Temperature	The temperature of the physical drive.
Firmware Revision Level	The revision level of the physical drive's firmware.
Power State	The Power State displays the following status: <ul style="list-style-type: none"> • On – A physical drive is spun up. • Powersave – A physical drive is spun down.
Unmap Capable	The device maximum supported speed.
Write Same Unmap Capable	Reclaim the storage space that is not in use.
Physical Sector Size	The size of the physical sector of the drive. The possible options are 4 KiB or 512 B.
Media Error Count	The number of media errors detected while communicating with LUNs.
Multipath	EID and slot number of the path if the drive is in multipath.
Multiport	EID and slot number of the path if the drive is in multiport.
Current Write Cache	The current write cache setting of the LUNs.
Default Write Cache	The default write cache setting of the LUNs.
Commissioned Spare	Indicates whether the drive is a commissioned spare.
Emergency Spare	Indicates whether the drive is an emergency spare.
Shield Diagnostics Completion Time	Indicates the shield diagnostics completion time. This property is displayed only if the controller supports shield state.
ATA Security Enabled	Indicates if the SATA security feature is enabled or disabled.
Drive Authority Locked Out	This state occurs if there are repeated authentication failures.

Viewing Volatile Properties

Select **Volatile Properties** to view the volatile properties of the controller and physical drive.

Figure 78: Physical Drive Volatile Properties Window

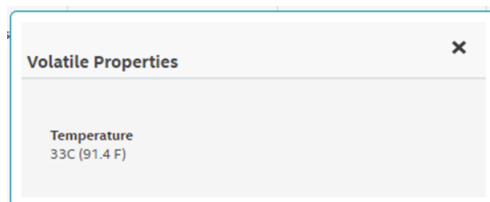
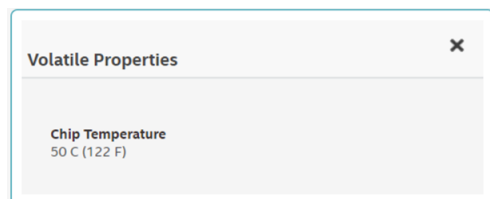

Figure 79: Controller Volatile Properties Window



Locating Tape Drives



If your system is connected to tape drives, LSA lists those connected tape drives. The tape drive is represented with a special (tape ) icon in the **Type** column of the **Physical Drives** tab.

Figure 80: Tape Drive

1 Unconfigured Drives 1 Unconfigured good

Enclosure : Slot	Device ID	Type	Interface	Capacity	Sector Size	Status	Model
 EN_0:8	1	TAPE	SAS	0B	512B	Unconfigured good	ULTRIUM5

Start and Stop Locating a Drive

If the physical drives are in a disk enclosure, you can identify them by making their LEDs blink.

Perform the following steps to identify the physical drives.

1. Navigate to the physical drive on the Controller dashboard, and select the drive you want to identify, such as Unconfigured Good drive, online physical drive, configured drive, and so on.
2. Select **Element(s) Actions > Start Locate**.
The corresponding LED on the physical drive starts blinking.
3. Select **Element(s) Actions > Stop Locate** to stop the LED from blinking.

Making a Drive Offline

Perform the following steps to place a drive offline.

ATTENTION

After you perform this procedure, all of the data on the drive will be lost.

1. Navigate to the Controller dashboard, and click a drive group name (for example, **DG_1**).
Click the  icon that corresponds to a drive group to display its contents.
The virtual drives and physical drives associated with the selected drive group appear.
2. Click the **Physical Drive** tab, and select a drive that you want to place offline.
3. Select **Element(s) Actions > Make Offline**.
The drive status changes to Offline.

Making a Drive Online

You can change the state of a physical drive to online. In an online state, the physical drive works normally and is a part of a configured virtual drive.

1. Navigate to the Controller dashboard, and click a drive group name (for example, **DG_1**).
Click the  icon that corresponds to a drive group to display its contents.
The virtual drives and physical drives associated with the selected drive group appear.

2. Click the **Physical Drive** tab, and select the offline drive that you want to make online.
3. Select **Element(s) Actions > Make Drive Online**.
The drive status changes to Online.

Replacing a Drive

You might want to replace a drive if the drive shows signs of failing. Before you start this operation, be sure that an available unconfigured good replacement drive is available. The replacement drive must have at least as much capacity as the drive you are replacing. Perform the following steps to replace a drive.

ATTENTION

Make sure to back up the data on the drive before you replace it.

1. Navigate to the Controller dashboard, and click a drive group name (for example, **DG_1**).
Click the  icon that corresponds to a drive group to display its contents.
The virtual drives and physical drives associated with the selected drive group appear.
2. Click the **Physical Drive** tab, and select a drive which you want to replace.
3. Select **Element(s) Actions > Start Replace Drive**.
The **Replace Drive** dialog appears.

Figure 81: Replace Drive Dialog



4. Select a replacement drive, and click **Replace Physical Drive**.
A confirmation message appears.
5. Select **Confirm** and click **Yes, Replace Drive** to proceed with the replace operation.
The drive is replaced and the data is copied to the selected component.

Marking a Drive as a Missing Drive

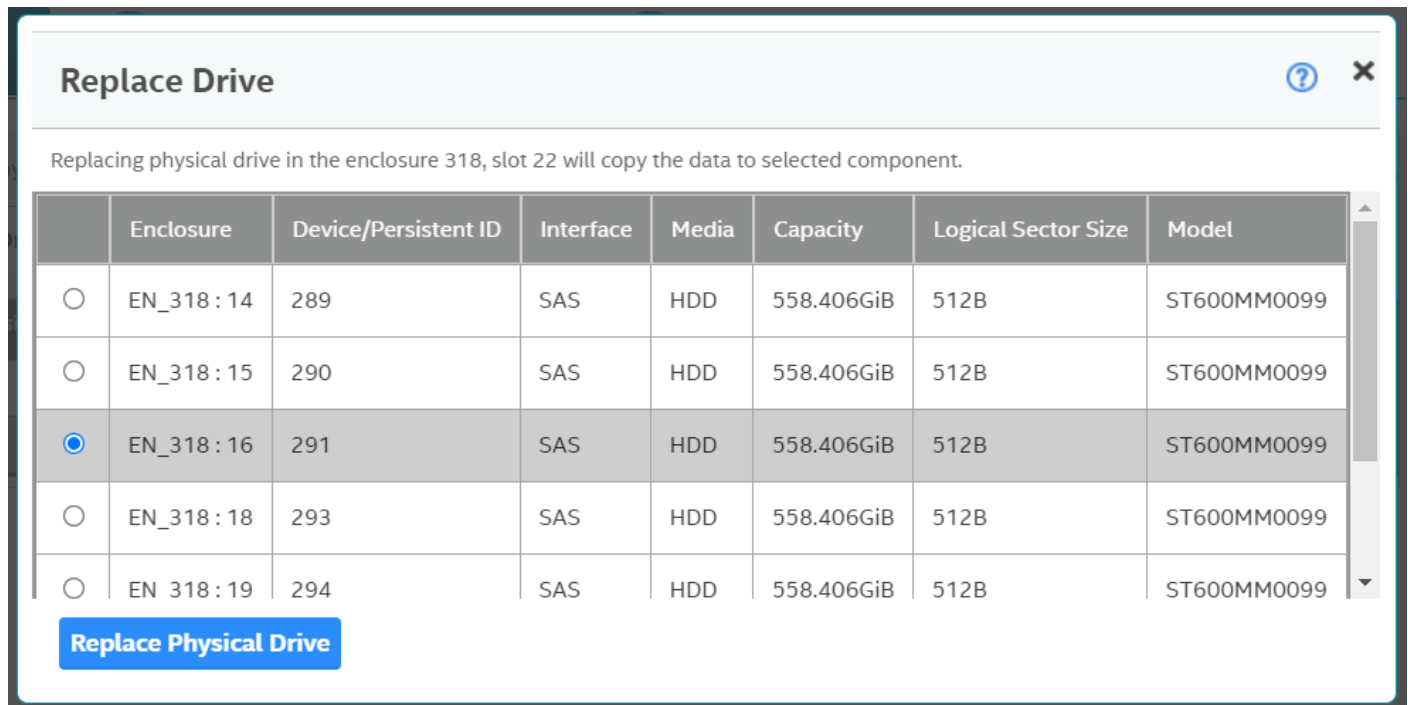
If a drive is currently part of a redundant configuration and if the drive is displaying signs of failure, you can mark the drive as missing and start rebuilding data on that drive.

1. Navigate to the Controller dashboard and select **Drive Groups**.
2. Click a drive group name (for example, **DG_1**).
3. Click the  icon that corresponds to a drive group to display its contents.
The virtual drives and physical drives associated with the selected drive group appear.
4. Click the **Physical Drive** tab, and select a drive which you want to mark as missing.
5. Select **Element(s) Actions > Mark Drive Offline**.
A confirmation dialog appears.
6. Select **Confirm** and click **Yes, Mark Drive Offline** to proceed towards marking the drive offline.
The drive is marked as offline as shown in the following figure.

Figure 82: Mark Drive Offline Dialog



7. Navigate to the **Drives** tab and expand the **Configured Drives** section to see the drives that are offline.
8. Select a drive whose status is offline and go to **Element(s) Actions > Mark Missing**.
9. Navigate to the **Drives** tab.
10. Select an Unconfigured Good drive from the list of Unconfigured Good drives, and go to **Element(s) Actions > Replace Missing Drive**.

The **Replace Missing Drive** dialog appears.

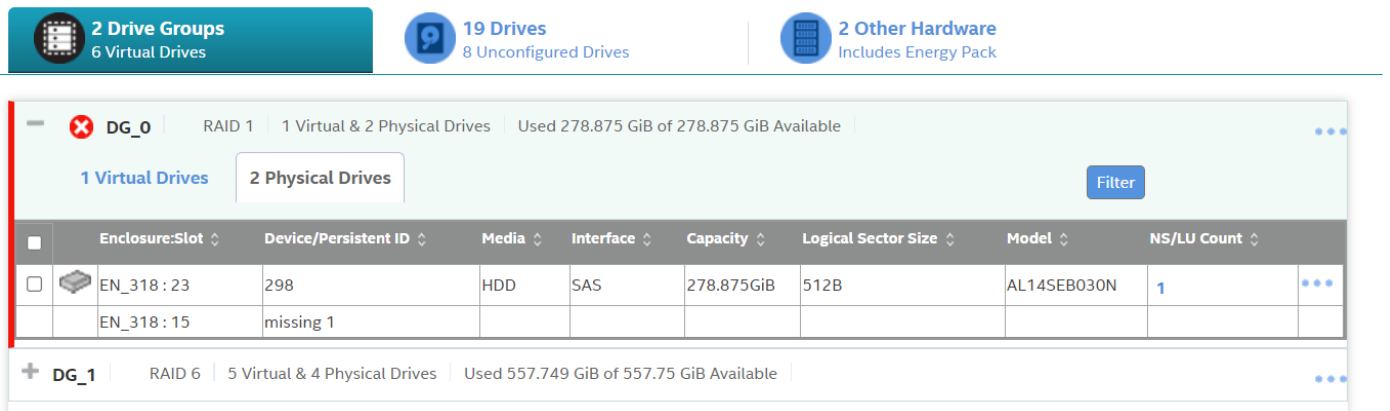
Figure 83: Replace Missing Drive Dialog

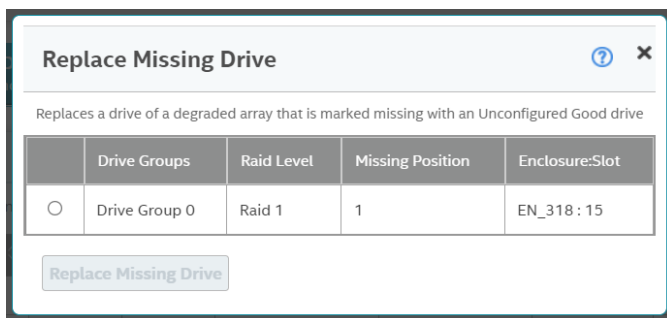

11. Select the drive and click **Replace Missing Drive**.
12. Navigate to the **Drive Groups** tab and select a new drive.
13. Click **Element(s) Actions > Start Rebuild**.

Replacing a Missing Drive

1. Navigate to the Controller dashboard and select **Drive Groups**.
2. Create a new drive group for any RAID level with two drives.
3. Navigate to the drive group, and mark one of the physical drives from disk group 0 as offline.
4. Select the physical drive that is marked as offline, and click **Mark the drive as missing**.
5. Select **Unconfigured drives**, then select the physical drive, and then **Replace Missing Drive**.
6. Select the drive group where you want to replace the missing physical drive.
7. Click **Ok**.

Viewing Protected Drive Groups

Perform the following steps to view a list of protected drive groups.

1. Navigate to the Controller dashboard, and click the **Drives** tab.
All of the associated drives appear.
2. Expand **Hot Spares**, and select a PD.

Figure 84: Show Protected Drive Groups

The screenshot shows the 'Drives' tab in the Storage Authority software. At the top, there are three summary cards: '2 Drive Groups (2 Virtual Drives)', '27 Drives (19 Unconfigured Drives)', and '3 Other Hardware (Includes Energy Pack)'. Below these are expandable sections for '2 Foreign Drives', '18 Unconfigured Drives (17 Unconfigured Good & 1 Unusable)', '5 Configured Drives (5 Online)', and '2 Hot Spares (1 Dedicated Hot Spare & 1 Global Hot Spare)'. A 'Filter' button is located to the right of the 'Hot Spares' section. Below the 'Hot Spares' section is a table with columns: Enclosure : Slot, Device/Persistent ID, Media, Interface, Capacity, Logical Sector Size, Status, Model, and NS/LU Count. Two rows are visible, both for enclosure EN_324. The first row is for slot 9 (Hot Spare) with status 'Dedicated Hot Spare'. The second row is for slot 10 (Hot Spare) with status 'Global Hot Spare' and is selected with a blue checkmark. To the right of the table, an 'Element(s) Actions' menu is open, listing: 'Show Protected Drive Groups', 'Unassign Global Hot Spare', 'Start Locate', and 'Stop Locate'.

Enclosure : Slot	Device/Persistent ID	Media	Interface	Capacity	Logical Sector Size	Status	Model	NS/LU Count
EN_324 : 9(Hot Spare)	290	HDD	SAS	278.937GiB	512B	Dedicated Hot Spare	HUC156030CSS200	1
EN_324 : 10(Hot Spare)	291	HDD	SAS	278.937GiB	512B	Global Hot Spare	HUC156030CSS200	1

3. Select **Element(s) Actions > Show Protected Drive Groups**.
The **Drive Group** lists appears.

Figure 85: Protected Drive Groups

Hot Spare enclosure 324, slot 10 protected drive group list

Drive Groups	Raid Level	Configured Capacity
DG_0	Raid 1	278.875GiB
DG_1	Raid 5	557.75GiB

Assigning Global Hot Spares

A global hot spare replaces a failed physical drive in any redundant array, as long as the capacity of the global hot spare is equal to or larger than the coerced capacity of the failed physical drive.

Perform the following steps to assign global hot spares.

1. Navigate to the Controller dashboard, and click the **Drives** tab.
All of the associated drives appear.
2. Expand **Unconfigured Drives**, and select an unconfigured good drive.
3. Select **Element(s) Actions > Assign Global Hot Spare**.
The unconfigured good drive is changed to a global hot spare. The status of the unconfigured good drive appears as a global hot spare in the **Hot Spares** section.

Removing Global Hot Spares

Perform the following steps to remove a hot spare.

1. Navigate to the Controller dashboard, and click the **Drives** tab.
All of the associated drives appear.
2. Expand **Hot Spares**, and select a hot spare that you want to remove.
3. Select **Element(s) Actions > Remove Global Hot Spare**.
The hot spare drive is removed and is listed in the **Unconfigured Drives** section as an unconfigured good drive.

Assigning Dedicated Hot Spares

Dedicated hot spare drives provide protection to one or more specified drive groups. Only one drive at a time may be assigned as a dedicated hot spare to a drive group.

If you select an Unconfigured Good drive, you have the option of assigning it as a dedicated hot spare drive.

Perform these steps to assign a dedicated hot spare.

1. Navigate to the Controller dashboard, and click the **Drives** tab.
All of the associated drives appear.

- Expand **Unconfigured Drives**, and select an unconfigured good drive.
- Select **Element(s) Actions > Assign Dedicated Hot Spare**.

The **Drive Groups** dialog appears.

Figure 86: Drive Groups Dialog

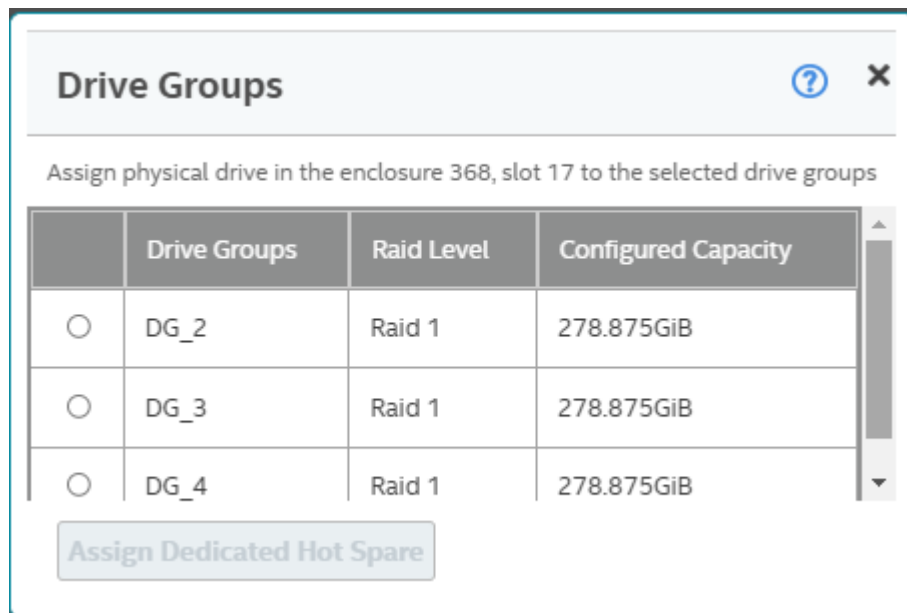

- Select the corresponding radio button of a drive group and click **Assign Dedicated Hot Spare**.

A confirmation message appears. The unconfigured good drive is now changed to a dedicated hot spare. The status of the unconfigured good drive appears as a dedicated hot spare in the **Hot Spares** section.

Rebuilding a Drive

If a drive, which is configured as RAID 1, 5, 6, 10, 50, or 60 fails, the LSI Storage Authority software automatically rebuilds the data on a hot spare drive to prevent data loss. The rebuild is a fully automatic process. You can monitor the progress of drive rebuilds in the **Background Processes in Progress** window. See [Background Operations Support](#).

Converting an Unconfigured Bad Drive to an Unconfigured Good Drive

Perform the following steps to convert an unconfigured bad drive to an unconfigured good drive.

- Navigate to the Controller dashboard, and click the **Drives** tab.
All of the associated drives appear.
- Expand **Unconfigured Drives**, and select an unconfigured bad drive.
- Select **Element(s) Actions > Make Unconfigured**.
A confirmation message appears.
- Select **Confirm** and click **Yes, Make Unconfigured** to proceed with the operation.
A confirmation message appears.
- Select **Confirm** and click **Yes, Make Good** to proceed with the operation.
The unconfigured bad drive is changed to unconfigured good drive. The status of the unconfigured bad drive appears as unconfigured good in the **Unconfigured Drives** section.

Removing a Drive

You might need to remove a non-failed drive that is connected to the controller. Preparing a physical drive for removal spins the drive into a power save mode.

1. Navigate to the Controller dashboard, and click the **Drives** tab.
All of the associated drives appear.
2. Expand **Unconfigured Drives**, and select a drive that you want to remove.
3. Select **Element(s) Actions > Prepare for Removal**.
The drive is in the power save mode and is ready for removal.
4. Wait until the drive spins down and then remove it.
If you do not want to remove the drive, select **Element(s) Actions > Undo Prepare for Removal**.

Making Different Types of Drives

When you power-down a controller and insert a new physical drive and if the inserted drive does not contain valid DDF metadata, the drive status is listed as **JBOD** (Just a Bunch of Drives) when you power the system again. When you power-down a controller and insert a new physical drive and if the drive contains valid DDF metadata, its drive state is **Unconfigured Good**. A new drive in the JBOD drive state is exposed to the host operating system as a stand-alone drive. You cannot use JBOD drives to create a RAID configuration, because they do not have valid DDF records.

If the controller supports JBOD drives, the LSI Storage Authority includes options for converting JBOD drives to an unconfigured good drive, or vice versa.

You can make the following types of drives:

- Unconfigured
- Good
- JBOD

Making an Unconfigured Drive

Perform the following steps to change the status of JBOD drives to Unconfigured.

1. Navigate to the Controller dashboard, and click the **Drives** tab.
All of the associated drives appear.
2. Expand **JBOD**, and select a JBOD drive.
3. Select **Element(s) Actions > Make Unconfigured**.
A confirmation message appears.
4. Select **Confirm** and click **Yes, Make Unconfigured** to proceed with the operation.
The JBOD drive is changed to an unconfigured drive.

Making a Good Drive

Perform the following steps to change the status of JBOD drives to Good.

1. Navigate to the Controller dashboard, and click the **Drives** tab.
All of the associated drives appear.

2. Expand **JBOD**, and select a JBOD drive.
3. Select **Element(s) Actions > Make Good**.
A confirmation message appears.
4. Select **Confirm** and click **Yes, Make Good** to proceed with the operation.
The JBOD drive is changed to a good drive.

Making a JBOD Drive

Perform these steps to change the status of unconfigured good drives to JBOD.

1. Navigate to the Controller dashboard, and click the **Drives** tab.
All of the associated drives appear.
2. Expand **Unconfigured Drives**, and select an unconfigured good drive.
3. Select **Element(s) Actions > Make JBOD**.
The unconfigured good drive is changed to a JBOD drive.

Erasing a Drive

You can erase data on non-SEDs (normal HDDs) by using the **Drive Erase** option. For non-SEDs, the erase operation consists of a series of write operations to a drive that overwrites every user-accessible sector of the drive with specified patterns. It can be repeated in multiple passes using different data patterns for enhanced security. The erase operation is performed as a background task.

Perform the following steps to erase a drive.

1. Navigate to the Controller dashboard, and click the **Drives** tab.
All of the associated drives appear.
2. Expand **Unconfigured Drives** and select an unconfigured good drive.
3. Select **Element(s) Actions > More Actions > Drive Erase**.
The **Physical Drive Erase** dialog appears.

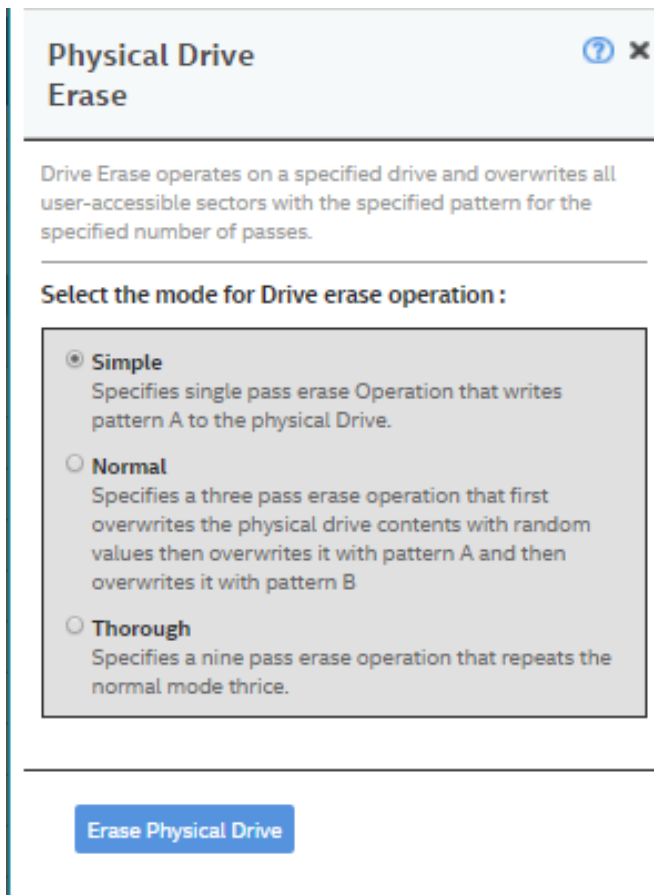
Figure 87: Physical Drive Erase Dialog

The dialog shows the following modes:

- **Simple**
- **Normal**
- **Thorough**

4. Select a mode, and click **Erase Physical Drive**.

A warning message appears asking for your confirmation.

5. Click **Yes, Erase Drive**.

After the drive erase operation has started, the **Stop Erase** option is enabled in the **Element(s) Actions** menu. You can monitor the progress of the erase operation. See [Background Operations Support](#).

Erasing a Drive Securely

The Instant Secure Erase feature erases data from encrypted drives.

ATTENTION

All data on the drive is lost when you erase it. Before starting this operation, back up any data that you want to keep.

1. Navigate to the Controller dashboard, and click the **Drives** tab.

All of the associated drives appear.

2. Expand **Unconfigured Drives**, and select an unconfigured good drive.
3. Select **Element(s) Actions > Instant Secure Erase**.
A confirmation message appears.
4. Select **Confirm** and click **Yes, Securely Erase Drive** to proceed with the operation.
After the secure erase operation has started, the **Stop Erase** option is enabled in the **Element(s) Actions** menu. You can monitor the progress of the erase operation. See [Background Operations Support](#).

Sanitizing a Drive

You can erase the data residing on a drive using the **Sanitize** feature. The **Sanitize** option is similar to the *Drive Erase* feature that is already supported by your controller. The difference is that the **Sanitize** option is performed by the drive firmware, whereas the *Drive Erase* feature is performed by the controller firmware.

The Sanitize option is an industry standard SCSI feature and uses an industry standard Sanitize SCSI Block command. The Sanitize operation is constantly monitored the by controller firmware. Drive sanitization progress events are communicated through the Background Operations Support feature.

To sanitize a drive, you must make sure that:

- The selected drive is in an Unconfigured Good state.
- The selected drive is not a JBOD drive.
- The selected drive is not part of any array, dedicated spare drive, or global spare drive.

Sanitize is enabled only when there is no other operation in progress on the selected drive.

When the Sanitize operation is in progress, you cannot perform any other operation on the drive that is being sanitized.

Perform the following steps to sanitize a drive:

1. Navigate to the Controller dashboard and click the **Drives** tab.
All the associated drives appear.
2. Expand **Unconfigured Drives** and choose an unconfigured good drive.
 - You can run a drive sanitization operation on multiple Unconfigured Good drives at the same time.
However, the Sanitize option is only enabled when the same type of sanitize operation is supported on all the selected drives. For example, on solid-state drives (SSDs), **Block Erase** is allowed, and on hard disk drives (HDDs), **Overwrite** is allowed.
 - You cannot run the Sanitize operation on mixed drive types.
For example, you have selected two drives to run the Sanitize operation; one of them is an SSD and the other one is an HDD. In this scenario, you cannot run the Sanitize operation because the drives are not the same type, nor are they of the same sanitize operation type.
3. Select **Element(s) Actions > More Actions > Start Sanitize**.
The **Sanitize Drive** dialog appears.

NOTE

After you start the drive sanitize operation, you cannot stop or pause the operation until it is complete.

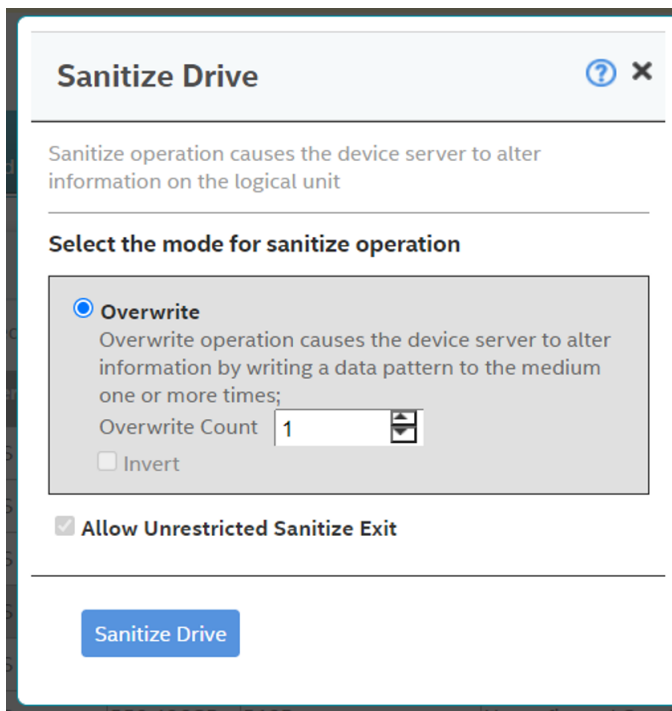
Figure 88: Sanitize Dialog

Depending on the drives you have selected for sanitization (SSDs or HDDs), the following options are available:

- **Overwrite** – If you have selected HDD, you can sanitize the physical using the Overwrite option.
This option writes a particular data pattern on the drive one or more times.
- **Block Erase** – If you have selected SSDs, you can sanitize the drives using the Block Erase option.
This option sets the physical blocks on the drive to a vendor-specific value.
- **Cryptographic Erase** – A cryptographic erase causes the device server to change secure keys to prevent the decryption of previously stored information. A cryptographic erase may result in protection information becoming indeterminate.
This option writes a particular data pattern on the drive one or more times.
- **Invert** – If this checkbox is select, then the user data and protection information are inverted on each consecutive overwrite.
- **Allow Unrestricted Sanitize Exit** – If, for some reason, the Sanitize operation fails, the system tries to bring the drive out of the failure mode irrespective of whether you select this check box or not.
However, if this check box is selected, and if the system succeeds in bringing the drive out of the failure mode, the drive is then returned as an Unconfigured Good drive. If you do not select this check box, and if the Sanitize operation fails, the system places the drive in an Unconfigured Bad state.

4. Click **Sanitize Drive**.

A confirmation message appears.

5. Click **Yes, Sanitize Drive(s)** to start sanitizing the selected drives.

You can monitor the progress of the Sanitize operation in the Background Operations section. The status of the drive is also displayed as **Sanitize** until the sanitization operation completes.

The following figure displays Background Operations section where the Sanitize operation is in progress.

Figure 89: Background Operations and Drive Sanitize Dialog

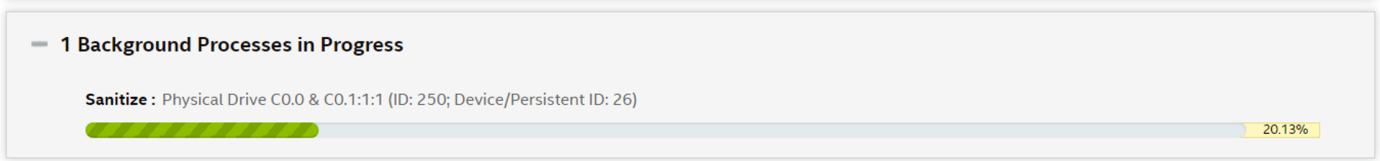

Managing Hardware Components

The LSI Storage Authority software enables you to manage the hardware components associated with the controller. When you select the **Other Hardware** tab from the Controller dashboard, the hardware components associated with the controller are displayed.

Figure 90: Other Hardware

Enclosure Slot	Device/Persistent ID	Media	Interface	Capacity	Logical Sector Size	Status	Model	NS/LU Count
EN_318 : 0	275	HDD	SAS	278.937GiB	4KiB	Online	HUC156030CS4204	1
EN_318 : 6	281	HDD	SAS	136.219GiB	512B	Online	ST91467035S	1
EN_318 : 8	283	HDD	SAS	465.25GiB	512B	Failed	ST95004315S	1
EN_318 : 9	284	HDD	SAS	278.937GiB	4KiB	Unconfigured Good	HUC156030CS4204	1
EN_318 : 10	285	HDD	SAS	278.937GiB	4KiB	Unconfigured Good	HUC156030CS4204	1
EN_318 : 11	286	HDD	SAS	278.937GiB	4KiB	Unconfigured Good	HUC156030CS4204	1
EN_318 : 12	287	HDD	SAS	558.406GiB	512B	Unconfigured Good	ST600MM0099	1
EN_318 : 13	288	HDD	SAS	558.406GiB	512B	Online	ST600MM0099	1
EN_318 : 14	289	HDD	SAS	558.406GiB	512B	Unconfigured Good	ST600MM0099	1
EN_318 : 15	290	HDD	SAS	558.406GiB	512B	Unconfigured Good	ST600MM0099	1
EN_318 : 16	291	HDD	SAS	558.406GiB	512B	Unconfigured Good	ST600MM0099	1
EN_318 : 17	292	HDD	SAS	558.406GiB	512B	Unconfigured Good	ST600MM0099	1
EN_318 : 19	294	HDD	SAS	558.406GiB	512B	Unconfigured Good	ST600MM0099	1
EN_318 : 20	295	HDD	SAS	558.406GiB	512B	Unconfigured Good	ST600MM0099	1
EN_318 : 21	296	HDD	SAS	278.875GiB	512B	Unconfigured Good	AL145EB030N	1
EN_318 : 22	297	HDD	SAS	278.875GiB	512B	Unconfigured Good	AL145EB030N	1
EN_318 : 23	298	HDD	SAS	278.875GiB	512B	Unconfigured Good	AL145EB030N	1

Monitoring Energy Packs

When the LSI Storage Authority software is running, you can monitor the status of all of the energy packs connected to the controllers in the server.

Learn Cycle

Learn cycle is an energy pack calibration operation that the controller performs periodically to determine the condition of the energy pack. You can start learn cycles manually or automatically. To choose automatic learn cycles, enable the automatic learn cycles feature. If you enable automatic learn cycles, you can delay the start of the learn cycles for up to 168 hours (7 days).

Viewing Energy Pack Properties

Select an energy pack from the **Other Hardware** tab in the Controller dashboard to view its properties.

The following figure and table describe the energy pack basic and advanced properties.

Figure 91: Energy Pack Properties Window

Energy Pack Properties

✕

Type TMMC	Status OPTIMAL	capacitance 94%	Charge Status None
Temperature Normal [24C (75.20F)]	Voltage 6710 mV	Current 0 mA	Manufacturer LSI
Serial Number 9271	Date of Manufacture 12:00:00 AM,26 Nov'15	Design Capacity 136 Joules	Remaining Capacity 120 Joules
Automatic Learn Mode Transparent (Learn Period: 27 Days 22 Hours)	Next Learn Cycle 11:50:27 PM,28 Aug'22		

Energy Pack properties

[Download](#) [View](#)

Table 15: Energy Pack Properties

Property	Description
Type	Type of the energy pack; for example, TMMC.
Status	Current status of the energy pack. The Status field has the following states: <ul style="list-style-type: none"> • Optimal • Missing • Critical • Degraded • Degraded [Needs Attention] • Unknown
capacitance	Indicated the percentage of capacitance of the Energy Pack.
Charge Status	Indicates if the Energy Pack is currently being charged.
Temperature	Indicates the current temperature of the Energy Pack. Also indicates whether the current temperature is normal or high.
Voltage	Voltage level of the energy pack, in mV. Also indicates if the current is normal or low.
Current	Current level of the energy pack, in mA.
Manufacturer	Manufacturer of the energy pack.
Serial Number	Serial number of the energy pack.
Date of Manufacture	Manufacturing date of the energy pack.
Design Capacity	Theoretical capacity of the energy pack.

Property	Description
Remaining Capacity	Remaining capacity of the energy pack.
Automatic Learn Mode	The current learn mode of the energy pack.
Next Learn Cycle	The time of the next learn cycle.

Refreshing Properties

Some of the properties, such as temperature and voltage in the **Properties** section, do not refresh automatically. You must manually refresh the **Properties** section to view the latest data.

Perform the following steps to refresh the data.

1. Navigate to the Controller dashboard, and click the **Other Hardware** tab.
All of the associated hardware connected to the controller appears.
2. Expand **Energy Pack**, and select a energy pack.
3. Select **Actions > Refresh Properties**.
The properties are updated.

Setting Learn Cycle Properties

Perform the following steps to set automatic learn cycle properties.

1. Navigate to the Controller dashboard, and click the **Other Hardware** tab.
All of the associated hardware connected to the controller appears.
2. Expand **Energy Pack**, and select an energy pack.
3. Select **Actions > Set Learn Cycle Properties**.
The **Set Learn Cycle Properties** dialog appears.
4. In the **Learn Cycle** drop-down list, select the **Enable** option.
The other two options are **Disable** and **Warn Via Event**.
 - If you select **Disable**, the automatic learn cycle is disabled.
The **Start On** and **Delay next learn cycle by** fields are also disabled.
 - If you select **Warn Via Event**, an event is generated notifying you when to start a learn cycle manually.
 - If a learn cycle is disabled or not scheduled, the value **None** appears in the **Next learn cycle time** field.
 - If a learn cycle is already scheduled, the day of the week, date, and time of the next learn cycle appears in the **Next learn cycle time** field.

NOTE

After selecting **Disable**, if you select **Enable** the controller firmware resets the energy pack module properties to initiate an immediate learn cycle. The **Next learn cycle** field is updated only after the energy pack relearn is completed. After the relearning cycle is completed, the value in the **Next learn cycle** field displays the new date and the time of the next learn cycle.

- Specify a day and time to start the automatic learn cycle in the **Start On** field.
- (Optional) Delay the start of the next learn cycle up to 7 days (168 hours) by specifying the day and hours in the **Delay next learn cycle by** field.
- Click **Save**.

Starting a Learn Cycle Manually

Perform the following steps to start the learn cycle properties manually.

- Navigate to the Controller dashboard, and click the **Other Hardware** tab.
All of the associated hardware connected to the controller appears.
- Expand **Energy Pack**, and select an energy pack.
- Select **Actions > Start Manual Learn Cycle**.
A confirmation message appears.
- Select **Confirm** and click **Yes, start manual learn cycle** to proceed with the operation.
The learn cycle operation starts.

Monitoring Enclosures

When the LSI Storage Authority software is running, you can monitor the status of all of the enclosures connected to the controllers in the server.

Viewing Enclosure Properties

From the **Other Hardware** tab, under **Enclosures**, select an enclosure to view its properties.

The following figure and table describe the enclosure basic and advanced properties.

Figure 92: Enclosure Properties

Property	Value
Vendor ID	LSI
Product ID	SAS3x40
Product Revision Level	0601
Fans Count	0
Temperature Sensors Count	2
ID	318
Location	EXTERNAL
Number of Slots	24
Type	SAS Expander
Connector	[C1.1 & C1.0]
SAS Address	0x500304801f38e0fd
Power Supplies Count	0
Serial Number	
Position	0
Voltage Sensors Count	2

[Click to download all the Enclosure or Logical Enclosure properties](#)

If you have selected multiple virtual drives or multiple physical drives, you must click the  (Expand button) to perform actions, such as starting a consistency check and so on. This is applicable for all the scenarios where you have selected multiple virtual drives or multiple physical drives and are performing certain actions through the **Actions** dialog.

Table 16: Enclosure Properties

Property	Description
Vendor ID	The vendor-assigned ID number of the enclosure.
ID	The ID of the enclosure in which the drive is located.
Type	The type of the enclosure.
Serial Number	The serial number of the enclosure.
Product ID	The product ID of the enclosure.
Location	Indicates whether the drive is attached to an internal connector or an external connector of the enclosure.
Connector	Indicates the connector name and size of wide port. Single Path: [Port 0-3 x4] – Single x4 Multipath: [Port 0-3 x4] & [Port 4-7 x4] – Two x4 Wide Ports: [Port 0-3 & Port 4-7 x8] – Single x8 wide port Single Drive: [Port 0-3 x1]
Position	The position of the enclosure.
Product Revision Level	The revision level of the enclosure's firmware.
Number of Slots	Total number of available slots.
SAS Address	The SAS address of the enclosure.
Fan count	Total number of fans that are connected.
Temperature Sensors Count	Total number of temperature sensors that are connected.
Power Supplies Count	Total number of power supplies that are connected.
Voltage Sensors Count	Total number of voltage sensors that are connected.

Viewing Partner Enclosure Properties

When the enclosure has a partner enclosure, the properties of the partner enclosure are displayed below the enclosure properties. See [Viewing Enclosure Properties](#) for information on the basic and advanced properties of the enclosure.

The following figure displays the enclosure properties and partner enclosure properties.

Figure 93: Enclosure or Logical Enclosure Properties

Enclosure or Logical Enclosure Properties ✕

ID 372	Product ID SAS3x40	Location INTERNAL	Connector [C0.0]
Type SAS Expander	Sub Type GENERIC	Vendor ID LSI	Serial Number
Position 0	Product Revision Level 0601	Number of Slots 24	Logical ID 0x500304801ECFF63F
SAS Address 0x500304801ecff6bd	Name SAS3x40		
Fans Count 0	Temperature Sensors Count 2	Power Supplies Count 0	Voltage Sensors Count 2

Enclosure or Logical Enclosure properties

Enclosure or Logical Enclosure Properties ✕

ID 328	Product ID SAS3x40	Location INTERNAL	Connector [C0.1]
Type SAS Expander	Sub Type GENERIC	Vendor ID LSI	Serial Number
Position 0	Product Revision Level 0601	Number of Slots 24	Logical ID 0x500304801ECFF63F
SAS Address 0x500304801ecff63d	Name SAS3x40		
Fans Count 0	Temperature Sensors Count 2	Power Supplies Count 0	Voltage Sensors Count 2

Enclosure or Logical Enclosure properties

[Download](#) [View](#)

Viewing Tape Drives



If your system is connected to tape drives, LSA lists those connected tape drives. The tape drive is represented with a special (tape ) icon, in the **Type** column under the **Enclosure** tab.

Figure 94: Tape Drive

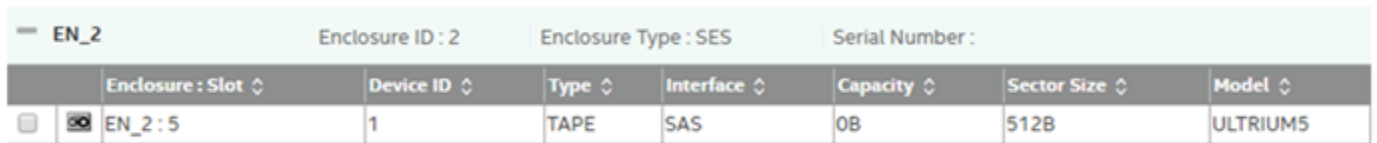

The screenshot shows a software interface for viewing tape drives. At the top, there is a header for enclosure 'EN_2' with sub-headers for 'Enclosure ID : 2', 'Enclosure Type : SES', and 'Serial Number :'. Below this is a table with columns: 'Enclosure : Slot', 'Device ID', 'Type', 'Interface', 'Capacity', 'Sector Size', and 'Model'. A single row is visible with the following values: 'EN_2 : 5', '1', 'TAPE', 'SAS', '0B', '512B', and 'ULTRIUM5'. The 'TAPE' type is accompanied by a small tape drive icon.

EN_2		Enclosure ID : 2		Enclosure Type : SES		Serial Number :	
Enclosure : Slot	Device ID	Type	Interface	Capacity	Sector Size	Model	
 EN_2 : 5	1	TAPE	SAS	0B	512B	ULTRIUM5	

3. Properties for Tape will be shown same as the other Physical Drive whatever is applicable for Tape Drive.

Show Events

The LSI Storage Authority software monitors the activity and performance of the server and all of the controllers cards attached to it.

Perform the following steps to view the event logs.

1. Select **Actions > Show Events** in the Server dashboard or the Controller dashboard.

The **Show Events** window appears that displays a list of events. Each entry has an event ID, a severity level that indicates the severity of the event, a date and time entry, and a brief description of the event. The event logs are sorted by date and time in chronological order.

Figure 95: Show Events Window

Severity Level	Event ID	Locale	Description	Time, Date
Information	357	Energy Pack	Energy pack is discharging	9:47:31 AM,25 Oct'21
Information	500	Controller	Host driver is loaded and operational	9:21:57 AM,25 Oct'21
Information	451	Physical Device SAS	Redundant path restored for PD 0x127(e0x13e/s20) Path (1) 0x5000c500af3fd8e1	9:20:24 AM,25 Oct'21
Information	548	Physical Device	Inserted: PD 0x127(e0x13e/s20)	9:20:24 AM,25 Oct'21
Information	451	Physical Device SAS	Redundant path restored for PD 0x11d(e0x13e/s10) Path (1) 0x5000c500af3fd345	9:20:24 AM,25 Oct'21
Information	548	Physical Device	Inserted: PD 0x11d(e0x13e/s10)	9:20:24 AM,25 Oct'21
Information	451	Physical Device SAS	Redundant path restored for PD 0x125(e0x13e/s18) Path (1) 0x5000c500af3fd6c9	9:20:24 AM,25 Oct'21
Information	548	Physical Device	Inserted: PD 0x125(e0x13e/s18)	9:20:24 AM,25 Oct'21
Information	451	Physical Device SAS	Redundant path restored for PD 0x123(e0x13e/s16) Path (1) 0x5000c500af4d1b1	9:20:24 AM,25 Oct'21
Information	548	Physical Device	Inserted: PD 0x123(e0x13e/s16)	9:20:24 AM,25 Oct'21
Information	451	Physical Device SAS	Redundant path restored for PD 0x12a(e0x13e/s23) Path (1) 0x5000c500af3e6dad	9:20:24 AM,25 Oct'21
Information	548	Physical Device	Inserted: PD 0x12a(e0x13e/s23)	9:20:24 AM,25 Oct'21
Information	451	Physical Device SAS	Redundant path restored for PD 0x129(e0x13e/s22) Path (1) 0x5000c500af3fd4e9	9:20:24 AM,25 Oct'21
Information	548	Physical Device	Inserted: PD 0x129(e0x13e/s22)	9:20:24 AM,25 Oct'21
Information	451	Physical Device SAS	Redundant path restored for PD 0x113(e0x13e/s0) Path (1) 0x5000c500af3e6791	9:20:24 AM,25 Oct'21
Information	548	Physical Device	Inserted: PD 0x113(e0x13e/s0)	9:20:24 AM,25 Oct'21
Information	451	Physical Device SAS	Redundant path restored for PD 0x117(e0x13e/s4) Path (1) 0x5000c500af4beb9	9:20:24 AM,25 Oct'21

2. (Optional) Click **Load More** to view more events in the same page.

NOTE

The View Event Log is empty when there are only process related events.

Downloading Events

To download the event logs, navigate to the **Show Events** window, and click **Download Events** to download the event log file.

Clearing Events

Perform the following steps to clear the event logs.

1. Click **Clear Events** in the **Show Events** window.
A confirmation dialog appears.
2. Select **Confirm**, and click **Yes, Clear Events**.
The event logs are cleared.

Customizing the Theme of the LSI Storage Authority Software

You can customize the theme of the LSI Storage Authority software to create a uniform look and feel that matches your organization's brand.



For example, you can add a company logo or change the default colors. The theme colors are applied globally throughout the software. You can make changes to the following themes:

- Company logo
- Header or banner background color

Viewing Default Theme Settings

The following table lists the default logo, color themes, and their associated values for the UI elements used in the LSA software.

Table 17: Default Theme Settings

Theme	Default	Default File Name/Property Name
Logo		mainlogo.png <root>\LSI\LSIStorageAuthority \server\html\ui\images Dimensions <ul style="list-style-type: none"> • Width – 263 pixels • Height – 43 pixels • Bit depth – 32 LSI Storage Authority is present in <root>\LSI\LSIStorageAuthority \server\html\js\message_en.js in the form of <Key>:<Value> format. This value string can be customized.
Header		headbackground.png <root>\LSI\LSIStorageAuthority \server\html\ui\images Dimensions <ul style="list-style-type: none"> • Width – 1172 pixels • Height – 125 pixels • Bit depth – 32

Customizing the Logo

Prerequisites

- The new logo must be in the .png format.
- Before you begin, make sure that the image already looks the way you want it to appear on the web page.
- Make sure the image has the right size (dimensions 372 pixels × 120 pixels)

- Width – 372 pixels
 - Height – 120 pixels
 - Bit depth – 32
1. Navigate to the `Images` directory: `<root>\LSI\LSIStorageAuthority\server\html\ui\images`
 2. Remove the default logo image file (`mainlogo.png`).
 3. Copy the new logo image file.

NOTE

Do not change the file name. Retain the same name, that is `mainlogo.png`.

4. Refresh the browser for the changes to take effect.

Customizing the Header Background Image

The logo appears in the header or banner of the software and is visible in all the pages you navigate in the software.

Perform the following steps to change the header background image.

Prerequisites

- The new logo must be in the `.png` format.
 - Before you begin, make sure that the image already looks the way you want it to appear on the web page.
 - Make sure the image has the right size:
 - Width – 1172 pixels
 - Height – 125 pixels
 - Bit depth – 32
 - Dimensions 372 pixels × 120 pixels
1. Navigate to the `Images` directory: `<root>\LSI\LSIStorageAuthority\server\html\ui\images`
 2. Remove the default header background image file (`headbackground.png`).
 3. Copy the new header background image file.

NOTE

Do not change the file name. Retain the same name, that is `headbackground.png`.

4. Refresh the browser for the changes to take effect.

Introduction to the Light Weight Monitor System

The Broadcom Light Weight Monitor (LWM) software provides server monitoring capabilities.

- [Overview](#)
- [Supported Operating Systems](#)
- [Alert Delivery Methods Based on Severity Levels](#)

Overview

LWM monitors the status of the controller cards, virtual drives, drives, and other devices on the server.

LWM alerts you of any issues that require immediate attention with system logs and real-time email notifications (based on the alert settings). For example, when the devices automatically go from an optimal state to a different state, such as a created virtual drive goes to a degraded state, the software gets those events from the controller. The software then sends a notification to you, using system logs and real-time email notifications based on different alert delivery methods.

Supported Operating Systems

The following table provides the OS support matrix for the Light Weight Monitor system.

Table 18: Supported Operating Systems

Operating System	Version
Microsoft	<ul style="list-style-type: none"> • Windows Server 2022 • Windows Server 2019 • Windows 10 (RS5) • Windows Client 11 21 H2 • Windows Client 11
Linux	<ul style="list-style-type: none"> • Red Hat Enterprise Linux 9.0 • Red Hat Enterprise Linux 9.0 (RTOS) • Red Hat Enterprise Linux 8.6 • Red Hat Enterprise Linux 8.6 (ROTS) • Red Hat Enterprise Linux 8.5 • Red Hat Enterprise Linux 8.4 • SUSE Linux Enterprise Server 15 SP4 • SUSE Linux Enterprise Server 15 SP3 • SUSE Linux Enterprise Server 15 SP2
VMware	<ul style="list-style-type: none"> • VMware ESXi 8.0 • VMware ESXi 7.0 U3c • VMware ESXi 7.0 U2 • VMware ESXi 7.0 U1
Ubuntu	<ul style="list-style-type: none"> • Ubuntu 22.04 LTS • Ubuntu 20.04 LTS

Alert Delivery Methods Based on Severity Levels

This section describes the alert delivery methods and severity levels.

Based on the severity level (Fatal, Critical, Warning, and Information), the default alert delivery methods change. By default, each severity level has one or more alert delivery methods configured for it, as shown in the following table. To modify these alert delivery methods, see [Changing the Default Alert Delivery Method for Each Severity Level](#). The software supports the following alert delivery methods:

- System log
- Email notification

Table 19: Severity Level and Default Alert Delivery Methods

Severity Level	Default Alert Delivery Method	Description
Fatal	System log and email notification	A component has failed, and data loss has occurred or will occur.
Critical	System log	A component has failed, but no data loss has occurred.
Warning	Warning	A component might be close to a failure point.
Information	System log	Informational message. No user action is necessary.

System Log

By default, the system log is maintained in the local system log (syslog). Depending on the operating system you are using, the system log is maintained in the following syslog locations:

- Windows – **Event Viewer > Windows Logs > Application**
- Linux – `/var/log/messages`

Email Notification

By default, fatal events are notified through system log and email notifications. You can configure these notifications using this feature.

Based on your configuration, the email notifications are delivered to your inbox in a format as shown in the following figure. The email notification contains information, such as event's description, system information, and the controller's image details. Using this additional information, you can determine the system and the controller on which the fatal error occurred.

Figure 96: Email Notification Format

```

From monitor@server.com Thu Apr 25 05:38:58 2002
Return-Path: <monitor@server.com>
Received: from 135.24.227.207 (linux-7kul.lsi.com [135.24.227.207])
    by dhcp-135-24-227-243.lsi.com (8.13.8/8.13.8) with ESMTTP id g3P08v6T031
181;
    Thu, 25 Apr 2002 05:38:57 +0530
Date: Mon, 5 Oct 2015 17:18:09 +0530 (IST)
From: monitor@server.com
To: root@dhcp-135-24-227-243.lsi.com, hema@dhcp-135-24-227-243.lsi.com
Message-ID: <1290884027.3519.1444045689147.JavaMail.root@linux-7kul.lsi.com>
Subject: Warning | Event occured on: linux-7kul.lsi.com
MIME-Version: 1.0
Content-Type: text/plain;charset="UTF-8"
Content-Transfer-Encoding: 7bit

Controller ID: 0 PD Predictive failure: Port 4 - 7:1:19
Event ID:96
Generated On: Mon Oct 05 17:18:19 IST 2015

System Details---
Server IP:135.24.227.207
OS name:Linux
OS Version:3.0
Driver Name:megaraid_sas
Driver Version:06.810.07.00

Image Details---
BIOS Version : 6.30.03.0_4.17.08.00_0x06130200
Firmware Package Version: 24.12.0-0011
Firmware Version : 4.620.00-4804

```

The Light Weight Monitor supports one of the SMTP authorization protocols called Auth Login. If your SMTP server is configured with Auth Login support, you must enable the Light Weight Monitor with login-specific information. For more information, see [Setting Up the Email Server](#).

By default, the Light Weight Monitor sends the email notification to the configured recipients. The recipients' information is based on your SMTP configuration. You can configure the SMTP configuration to add one or more recipient addresses. For more information, see [Adding the Email Addresses of Alert Notification Recipients](#).

Time Synchronization

A mismatch between the controller time settings and the OS time setting is possible during daylight savings time (DST) or known lower layer limitations. In this case, the timestamp will be different on the I/O. The Light Weight Monitor resolves this limitation by synchronizing the OS time and the controller time on an hourly basis.

NOTE

This is a default feature of the Light Weight Monitor software. This feature is not configurable.

Installing the Light Weight Monitor System

This section provides information on installing the Light Weight Monitor System.

Two ways to install the Light Weight Monitor system exist:

- Through the LSI Storage Authority Master Setup
- Through the Light Weight Monitor stand-alone installation.

Installing the LSI Storage Authority Software on the Windows Operating System through the LSA Master Setup

Perform the following steps to install the LWM using the LSI Storage Authority Master Setup.

1. Run the LSI Storage Authority `setup.exe` file.
The **InstallShield Wizard** dialog appears.
2. Click **Next**.
The **License Agreement** dialog appears.
3. Read the agreement and choose the **I accept the terms in the license agreement** radio button, and click **Next**.
The **Customer Information** dialog appears.
4. (Optional) Enter your user name and the organization name, and click **Next**.
The **Port Configuration Settings** dialog appears.

By default, LSA communicates on web server port 2463 and LSA server port 9000. Make sure these ports are available to be used by LSA. Depending on your environment, if these ports are not available, specify the port details here. You also can edit these port details after installation.

5. Click **Next** if you want to proceed with the default port configuration settings.
The **Destination Folder** dialog appears with the default file path.
6. (Optional) Click **Change** to select a different destination folder for the installation files.
7. Click **Next**.

The **Configure Range of Events to Generate Alert Notifications** dialog appears. You can configure alert notifications to get early notification of application or service issues or problem occurrences before they affect you.

Figure 97: Configure Range of Events to Generate Alert Notifications Dialog

The following configuration options are available:

- **Since Last Shutdown:** Select this option to retrieve events from the last clean shutdown.
- **Since Log Clear:** Select this option to retrieve events from the last log that was cleared.
- **Since Last Reboot:** Select this option to retrieve events from the last time the system was restarted.
- **Start From Now:** Select this option to retrieve events from now.

You can change these configuration options as per your requirement, at any point in time.

You can also change these configuration options per your requirement at any point in time by editing the `lsa.conf` file in the `LSI Storage Authority /conf` directory and choosing the required parameter. For example, if you have selected **Since Last Shutdown** as a configuration option to retrieve events during the time of installation and you want to change it to **Since Last Reboot**, through the `lsa.conf` file, go to `# Retrieve range of events used to generate alert notification, if LSA not found LastProcessedSeqNum` section in the `lsa.conf` file, change the `retrieve_range_of_events_since = to 2` (`retrieve_range_of_events_since = 2`).

NOTE

You must restart the LSI Storage Authority service for the configuration changes to take effect.

8. Click **Next**.

The **Setup Type** dialog appears.

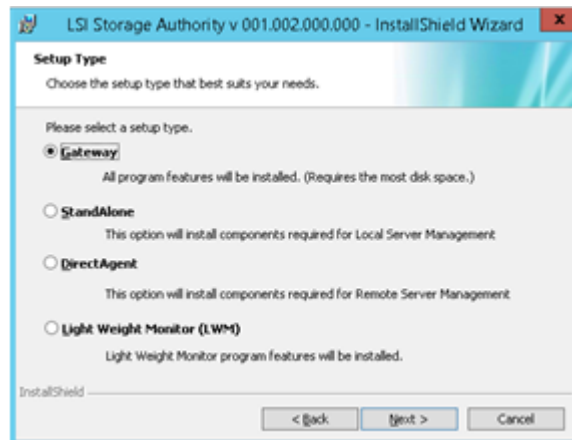
Figure 98: Setup Type Dialog

9. Select Light Weight Monitor (LWM).

10. Click **Next**. The **Ready to Install the Program** window appears. Click **Next**.

Depending on the setup type you have selected, the **InstallShield Wizard Completed** dialog appears.

11. (Optional) Select the **Show the Windows Installer log** check box to view the windows installer log file.

The log file (`LSA_install.log`) is created in the same folder from where the `setup.exe` command is executed.

12. Click **Finish**.

The Light Weight Monitor is successfully installed.

Installing the Light Weight Monitor on the Windows Operating System through the LSA Stand-Along Installation

Perform the following steps to install LWM through the LSI Storage Authority Master Setup on the Windows OS.

1. Download and extract the installation package.
2. Log in to the system with administrator privileges.
3. Run the `setup.exe` file.
4. Follow the on-screen instructions to complete the installation procedure.

The LWM agent is installed in the following directory path:

```
<ProgramFilesFolder>\LSI\LSIStorageAuthority
```

Uninstalling Light Weight Monitor Software on the Windows Operating System

You can uninstall the Light Weight Monitor software either through the **Control Panel** or through the application shortcut in the **Start** menu.

Uninstalling the Software through the Application Shortcut from the Start Menu

1. Select **Start > All Programs > LSI > LSIStorageAuthority > Uninstall LSA**.

The Light Weight Monitor package and all of the installed files are removed.

Uninstalling the Software through the Control Panel

1. To uninstall the software, select **Programs and Features** from the **Control Panel**.
2. Select the Light Weight Monitor software from the listed programs and click **Uninstall**.

The Light Weight Monitor package and all of the installed files are removed.

Installing the Light Weight Monitor on the Linux Operating System

Perform the following steps to install the LWM on the Linux OS.

1. Log on to the system with root privileges.
2. Run the following command:

```
rpm -ivh LightWeightMonitor-<x.xx.xx-xx>
```

Where: *x.xx.xx-xx* is the Light Weight Monitor version number.

The LWM agent is installed in the following directory path:

```
opt/lsi/LSIStorageAuthority/
```

Uninstalling the Light Weight Monitor on the Linux Operating System

1. Run the following command to search for the Light Weight Monitor package.

```
rpm -qa | grep Light*
```

2. Select the Light Weight Monitor package from the listed programs, and run the following command to uninstall the package:

```
rpm -e LightWeightMonitor-<x.xx.xx-xx>
```

Where *x.xx.xx-xx* is the Light Weight Monitor version number.

Installing Light Weight Monitor on the Oracle Solaris x86 Operating System

GCC Runtime Library 4.5 or later is required to successfully install the Light Weight Monitor on the Oracle Solaris x86 OS. Refer to your Oracle Solaris (x86 platform) documentation for installation instructions.

1. Log in to the system with root privileges.
2. Unzip the Light Weight Monitor installation package.
3. Extract the contents of the `.zip` file.
4. Run the following command to install or update the Light Weight Monitor package.

```
./install.sh
```

The Light Weight Monitor is installed in the following directory path:

```
cd/opt/lsi/LSIStorageAuthority/
```

Uninstalling the Light Weight Monitor on the Oracle Solaris x86 Operating System

1. Run the following command to search for the Light Weight Monitor package:

```
pkginfo | grep lwmonitor
```

2. Select the Light Weight Monitor package from the listed programs, and run the following command to uninstall the package:

```
pkgrm lwmonitor
```

Configuring the Light Weight Monitor System

This section provides information on how to configure the LWM agent.

You must edit the `syslog.conf` and `config-current.JSON` files to configure the email server, alert settings, and system logs. These files have the write permissions. *Do not* edit any other files in the package.

NOTE

To revert back to the original settings, you must copy the contents of the `config-default.JSON` file to the `config-current.JSON` file. This action restores the configuration settings to its original state.

Setting Up the Email Server

Perform the following steps to configure the email server.

1. Open the `config-current.JSON` file in one of the following directories:

- Windows OS: `<ProgramFilesFolder>\LSI\LSIStorageAuthority\conf\monitor`
- Linux OS: `cd /opt/lsi/LSIStorageAuthority/conf/monitor`
- Solaris x86 OS: `cd /opt/lsi/LSIStorageAuthority/conf/monitor`

2. Make the following changes in the "email" sections of the files.

- Windows OS, Linux OS, and Solaris x86 OS:

Default Configuration:

```
"email":
{
  "isActive": true,
  "type": "EMAIL",
  "sender": "lsa-monitor@server.com",
  "server": "127.0.0.1",
  "to":
  [
    "root@localhost"
  ],
  "authentication":
  {
    "type": "NONE"
  }
}
```

Edit the `server` field with the IP address of your SMTP server. For example,

```
"server": "135.24.227.243"
```

3. If on your SMTP server, the Auth Login feature is enabled and if you want to enable this feature in the LWM agent, enter the following authentication details.

- Windows OS, Linux OS, and Solaris x86 OS:

Default Configuration:

```

"email":
{
  "isActive": true,
  "type": "EMAIL",
  "sender": "lsa-monitor@server.com",
  "server": "127.0.0.1",
  "to":
    [
      "root@localhost"
    ],
  "authentication":
    {
      "type": "NONE"
    }
}

```

Changes to Be Made

Enter the authentication details in the user name and password fields, and make the following changes in the "authentication" field.

```

"username": "lsi",
"password": "xxxx",
"authentication":
{
  "type": "AUTH-LOGIN"
}

```

Where: `lsi` represents SMTP server's user name and `xxxx` represents the Base 64 converted SMTP configuration password.

4. Save the `config-current.JSON` file.
5. Perform the following steps to restart the Light Weight Monitor services for the changes to take effect.

- Windows OS:

- a. In the command prompt, type the following command to stop the Light Weight Monitor service:

```
sc stop LSAService
```

- b. Type the following command to start the Light Weight Monitor service:

```
sc start LSAService
```

- Linux OS:

Run the following command:

```
/etc/init.d/LsiSASH restart
```

- Solaris x86 OS:

Run the following command:

```
/etc/init.d/LsiSASH restart
```

It is also recommended to restart the system log. To restart the system log, run the following command:

```
svcadm restart system-log
```

Setting Up the Custom Facility Level in the System Log File for the Solaris x86 Operating System

By default, LWM logs the event messages in the `/var/adm/messages` file with default facility level as `LOG_USER`. By setting up a custom facility level, you can:

- Filter LWM event messages from the `/var/adm/messages` file.
- Redirect event messages to different log files based on facility level.

Perform the following steps to configure the custom facility level:

1. Open the `config-current.JSON` file in the following directory:
`cd /opt/lsi/LSIStorageAuthority/conf/monitor`
2. Make the following changes in the "systemlog" sections of the files.

Default Configuration:

```
"systemlog":
{
  "isActive": true,
  "type": "SYSTEMLOG",
  "facilityLevel": "LOG_USER",
  "allowedFacilityLevels":
    [
      "LOG_MAIL",
      "LOG_DAEMON",
      "LOG_AUTH",
      "LOG_SYSLOG",
      "LOG_LPR",
      "LOG_NEWS",
      "LOG_UUCP",
      "LOG_LOCAL0",
      "LOG_LOCAL1",
      "LOG_LOCAL2",
      "LOG_LOCAL3",
      "LOG_LOCAL4",
      "LOG_LOCAL5",
      "LOG_LOCAL6",
      "LOG_LOCAL7"
    ]
}
```

Changes to Be Made

Edit the `facilityLevel` field, and enter any one of the options from `allowedFacilityLevels` field. For example, `facilityLevel: "LOG_MAIL"`.

3. Save the `config-current.JSON` file.
4. Run the following command to restart the Light Weight Monitor services for the changes to take effect:
`/etc/init.d/LsiSASH restart`

NOTE

Make necessary changes to the `/etc/syslog.conf` file, and then restart the system log service.

Adding the Email Addresses of Alert Notification Recipients

Perform the following steps to add email addresses of recipients of the alert notifications.

1. Open the `config-current.JSON` files in one of the following directories:

- Windows OS: `<ProgramFilesFolder>\LSI\LSIStorageAuthority\conf\monitor`
- Linux OS: `cd /opt/lsi/LSIStorageAuthority/conf/monitor`
- Solaris x86 OS: `cd /opt/lsi/LSIStorageAuthority/conf/monitor`

2. Make the following changes in the following sections of the files.

- Windows OS, Linux OS, and Solaris x86 OS:

In the "email" section and "to" field, add your email ID. You can add multiple email addresses by separating them with commas. For example,

```
"to": [ xxx@xx.com, abc@zyz.com, ... ]
```

Where: `xxx@xx.com` or `abc@zyz.com` represents your email ID.

3. Save the `config-current.JSON` file.

4. Perform the following steps to restart the Lightweight Monitor services for the changes to take effect.

- Windows OS:

a. Start the command prompt.

b. Type the following command to stop the Lightweight Monitor service:

```
sc stop LSAService
```

c. Type the following command to start the Lightweight Monitor service:

```
sc start LSAService
```

- Linux OS:

Run the following command:

```
/etc/init.d/LsisASH restart
```

Configuring Alert Settings

This section provides information on how to configure alert settings.

- [Changing the Default Alert Delivery Method for Each Severity Level](#)
- [Changing the Alert Delivery Method for a Specific Event](#)
- [Changing the Severity Level for a Specific Event](#)

Changing the Default Alert Delivery Method for Each Severity Level

Perform the following steps to change the default alert delivery methods for each severity level.

1. Open the `config-current.JSON` file in the following directories:
 - Windows OS: `<ProgramFilesFolder>\LSI\LSIStorageAuthority\conf\monitor`
 - Linux OS: `cd /opt/lsi/LSIStorageAuthority/conf/monitor`
 - Solaris x86 OS: `cd /opt/lsi/LSIStorageAuthority/conf/monitor`
2. For example, if you want to edit the default alert delivery method for the warning severity level from the system log to both the system log and email notification, make the following changes.
 - Windows OS, Linux OS, and Solaris x86 OS:

```
{
  "warning": [
    "systemlog",
    "email"
  ]
}
```

3. Save the `config-current.JSON` file.
4. Perform the following steps to restart the Light Weight Monitor services for the changes to take effect.
 - Windows OS:
 - a. Start the command prompt.
 - b. Type the following command to stop the Light Weight Monitor service:

```
sc stop LSAService
```

- c. Type the following command to start the Light Weight Monitor service:

```
sc start LSAService
```

- Linux OS:

Run the following command:

```
/etc/init.d/LsisASH restart
```

Changing the Alert Delivery Method for a Specific Event

Perform the following steps to change the alert delivery method for a specific event.

1. Open the `config-current.JSON` file in the following directories:

- Windows OS: `<ProgramFilesFolder>\LSI\LSIStorageAuthority\conf\monitor`
- Linux OS: `cd /opt/lsi/LSIStorageAuthority/conf/monitor`
- Solaris x86 OS: `cd /opt/lsi/LSIStorageAuthority/conf/monitor`

2. Make the following changes to the `events []` array.

- Windows OS, Linux OS, and Solaris x86 OS:

```
"events": [
  {
    "typeId": 4,
    "severity": "INFO",
    "actions": [
      "email"
    ]
  }
]
```

3. Save the `config-current.JSON` file.

4. Perform the following steps to restart the Light Weight Monitor services for the changes to take effect.

- Windows OS:

- a. Start the command prompt.
- b. Type the following command to stop the Light Weight Monitor service:

```
sc stop LSAService
```

- c. Type the following command to start the Light Weight Monitor service:

```
sc start LSAService
```

- Linux OS:

Run the following command:

```
/etc/init.d/LsisASH restart
```

Changing the Severity Level for a Specific Event

Perform the following steps to change the severity level for a specific event.

1. Open the `config-current.JSON` file in the following directories:

- Windows OS: `<ProgramFilesFolder>\LSI\LSIStorageAuthority\conf\monitor`
- Linux OS: `cd /opt/lsi/LSIStorageAuthority/conf/monitor`
- Solaris x86 OS: `cd /opt/lsi/LSIStorageAuthority/conf/monitor`

2. Make the following changes to the `events []` array.

- Windows OS, Linux OS, and Solaris x86 OS:

```
"events": [
  {
    "typeId": 4,
```

```
        "severity": "CRITICAL",
        "actions": [
            "global"
        ]
    }
]
```

3. Save the `config-current.JSON` file.
4. Perform the following steps to restart the Light Weight Monitor services for the changes to take effect.

- Windows OS:

- a. Start the command prompt.
- b. Type the following command to stop the Light Weight Monitor service:

```
sc stop LSAService
```

- c. Type the following command to start the Light Weight Monitor service:

```
sc start LSAService
```

- Linux OS:

Run the following command:

```
/etc/init.d/LsisASH restart
```

Introduction to RAID

This section describes a Redundant Array of Independent Disks (RAID), RAID functions and benefits, RAID components, RAID levels, and configuration strategies.

RAID Benefits

A RAID is an array or group of multiple independent physical drives that provide high performance and fault tolerance to improve I/O performance and reliability. The RAID drive group appears to the host computer as a single storage unit or as multiple virtual units. I/O is expedited because several drives can be accessed simultaneously.

RAID Benefits

RAID drive groups improve data storage reliability and fault tolerance compared to single-drive storage systems. Data loss that results from a drive failure can be prevented by reconstructing missing data from the remaining drives. RAID improves I/O performance and increases storage subsystem reliability.

RAID Functions

Virtual drives are drive groups or spanned drive groups that are available to the operating system. The storage space in a virtual drive is spread across all of the drives in the drive group.

Your drives must be organized into virtual drives in a drive group, and they must be able to support the RAID level that you choose. Some common RAID functions follow:

- Creating hot spare drives
- Configuring drive groups and virtual drives
- Initializing one or more virtual drives
- Accessing controllers, virtual drives, and drives individually
- Rebuilding failed drives
- Performing patrol read
- Verifying that the redundancy data in virtual drives on RAID 1, RAID 5, RAID 6, RAID 10, RAID 50, RAID 60, PRL-11, or Spanned PRL-11 is correct
- Reconstructing virtual drives after changing RAID levels or adding or removing drives to the same drive group
- Selecting a host controller on which to work

RAID Components and Features

RAID levels describe a system for ensuring the availability and redundancy of data stored on large disk subsystems. See [RAID Levels](#) for detailed information about RAID levels. The following subsections describe the components of RAID drive groups and RAID levels.

Drive Group

A drive group is a group of physical drives. These drives are managed in partitions known as virtual drives. You can create one or more virtual drives on a group of drives attached to a controller card. However, this is based on the support of sliced VD and RAID level of the controller.

Physical Drive States

A drive state is a property that indicates the status of the drive. The following table describes the drive states.

Table 20: Drive States

State	Description
Online	The physical drive is working normally and is a part of a configured logical drive.
Unconfigured Good	A drive that is functioning normally but is not configured as a part of a virtual drive or as a hotspare.
Hotspare	A drive that is powered up and ready for use as a spare in case an online drive fails.
Failed	A fault has occurred in the physical drive, placing it out of service.
Rebuild	A drive to which data is being written to restore full redundancy for a virtual drive.
Unconfigured Bad	A drive on which firmware detects some unrecoverable error; the drive was Unconfigured Good or the drive could not be initialized.
Missing	A drive that was Online but has been removed from its location.
Offline	A drive that is part of a virtual drive but has invalid controller configuration data.

Virtual Drive

A virtual drive is a partition in a drive group that is made up of contiguous data segments on the drives. A virtual drive can consist of these components:

- An entire drive group
- A part of a drive group
- A combination of any two of these conditions

Virtual Drive States

The virtual drive states are described in the following table.

Table 21: Virtual Drive States

State	Description
Optimal	The virtual drive operating condition is good. All configured drives are online.
Degraded	The virtual drive operating condition is not optimal. One of the configured drives has failed or is offline.
Partial Degraded	The operating condition in a RAID 6 and a RAID 60 virtual drive is not optimal. One of the configured drives has failed or is offline. If two drives fail in a RAID 6 drive group or from a single span RAID 60 drive group, the drives become degraded.
Failed	If one drive gets failed from a degraded virtual drive, the virtual drive is failed.
Offline	The virtual drive is not available to the controller card.

Fault Tolerance

Fault tolerance is the capability of the subsystem to undergo a drive failure or failures without compromising data integrity, and processing capability. The MegaRAID controller provides this support through redundant drive groups in RAID 1, RAID 5, RAID 6, RAID 10, RAID 50, RAID 60, PRL-11, and Spanned PRL-11 levels. The system can still work correctly even with a drive failure in a drive group, though performance might be degraded to some extent.

In a span of RAID 1 drive groups, each RAID 1 drive group has two drives and can tolerate one drive failure. RAID 1 drive groups can contain up to two drives. A RAID 5 drive group can tolerate one drive failure in each RAID 5 drive group. A RAID 6 drive group can tolerate up to two drive failures in each RAID 6 drive group.

Each span support single drive fault tolerance. A RAID 50 virtual drive can tolerate eight drive failures, as long as each failure is in a separate drive group. RAID 60 drive groups can tolerate up to 16 drive failures in each drive group.

NOTE

RAID 0 is not fault tolerant. If a drive in a RAID 0 drive group fails, the entire virtual drive (all drives associated with the virtual drive) fails.

Fault tolerance is often associated with system availability because it lets the system be available during the failures. However, fault tolerance means that it is also important for the system to be available during the repair of the problem.

A hot spare is an unused drive that, in case of a disk failure in a redundant RAID drive group, can rebuild the data and re-establish redundancy. After the hot spare is automatically moved into the RAID drive group, the data is automatically rebuilt on the hot spare drive. The RAID drive group continues to handle requests while the rebuild occurs.

The auto-rebuild feature lets a failed drive be replaced and the data automatically rebuilt by *hot-swapping* the drive in the same drive bay. The RAID drive group continues to handle requests while the rebuild occurs.

Multipathing

Firmware supports detecting and using multiple paths from the controller cards to the SAS devices that are in enclosures. Devices connected to enclosures have multiple paths to them. With redundant paths to the same port of a device, if one path fails, another path can communicate between the controller and the device. Using multiple paths with load balancing, instead of a single path, can increase reliability through redundancy.

Multipathing provides the following features:

- Support for failover, in the event of path failure
- Auto-discovery of new or restored paths while the system is online, and reversion to the system load-balancing policy
- Measurable bandwidth improvement to the multipath device
- Support for changing the load-balancing path while the system is online

Firmware determines whether enclosure modules are part of the same enclosure. When a new enclosure module is added (allowing multipath) or removed (going single path), an Asynchronous Event Notification is generated. AENs about drives contain correct information about the enclosure when the drives are connected by multiple paths. The enclosure module detects partner enclosure modules and issues events appropriately.

In a system with two enclosure modules, you can replace one of the enclosure modules without affecting the virtual drive availability. For example, the controller can run heavy I/Os, and, when you replace one of the enclosure modules, I/Os must not stop. The controller uses different paths to balance the load on the entire system.

Wide Port

The term *port* identifies a single connection point between devices, while the term *wide port* defines a group of individual phys used as a single connection point between SAS initiators, expanders, and targets.

Consistency Check

Consistency check verifies the accuracy of the data in virtual drives that use RAID 1, RAID 5, RAID 6, RAID 10, RAID 50, RAID 60, PRL-11, and Spanned PRL-11. RAID 0 does not provide data redundancy. For example, in a system with parity, checking consistency means computing the data on one drive and comparing the results to the contents of the parity drive.

It is recommended to perform a consistency check at least once a month.

Replace

Replace lets you copy data from a source drive to a destination drive that is not a part of the virtual drive. Replace often creates or restores a specific physical configuration for a drive group (for example, a specific arrangement of drive group members on the device I/O buses). You can run Replace automatically or manually.

Typically, when a drive fails or is expected to fail, the data is rebuilt on a hot spare. The failed drive is replaced with a new disk. Then the data is copied from the online drive (which was previously an hot spare) to the new drive, and the hot spare reverts from a rebuilt drive to its original hot spare status. Replace runs as a background activity, and the virtual drive is still available online to the host.

Replace also is initiated when the first SMART error occurs on a drive that is part of a virtual drive. The destination drive is a hot spare that qualifies as a rebuild drive. The drive that has the SMART error is marked as *failed* only after the successful completion of Replace. This situation avoids putting the drive group in Degraded status.

NOTE

During Replace, if the drive group involved in Replace is deleted because of a virtual drive deletion, the destination drive reverts to an Unconfigured Good state.

Order of Precedence

In the following scenarios, rebuild takes precedence over Replace:

- If Replace is already taking place to a hot spare drive, and any virtual drive on the controller degrades, Replace aborts, and a rebuild starts. Rebuild changes the virtual drive to the Optimal state.
- The Rebuild takes precedence over Replace when the conditions exist to start both operations. Consider the following examples:
 - A hot spare drive is not configured (or unavailable) in the system.
 - Two drives (both members of virtual drives) exist, with one drive exceeding the SMART error threshold, and the other failed.
 - If you add a hot spare (assume a global hot spare) during a Replace, Replace ends abruptly, and rebuild starts on the hotspare drive.

Background Initialization

Background initialization checks for media errors (soft and hard) on the drives when you create a virtual drive. It is an automatic operation that starts 5 minutes after you create the virtual drive. This automatic feature might not be supported for all the customers. This check makes sure that striped data segments are the same on all of the drives in the drive group.

Background initialization is similar to a consistency check. The difference between the two is that only a background initialization is forced on new virtual drives.

The RAID 5 virtual drives and RAID 6 virtual drives require a minimum number of drives for a background initialization to start. If there are fewer drives than the minimum required, the background initialization does not start. The following number of drives are required. However, it is customer-specific:

- New RAID 5 virtual drives must have at least five drives for the background initialization to start.
- New RAID 6 virtual drives must have at least seven drives for the background initialization to start.

The default and recommended background initialization rate is 30 percent. Before you change the rebuild rate, you must stop the background initialization, or the rate change does not affect the background initialization rate. After you the stop background initialization and change the rebuild rate, the rate change takes effect when you restart background initialization.

Patrol Read

Patrol read reviews your system for possible drive errors that could lead to drive failure and then performs action to correct errors. The goal is to protect data integrity by detecting drive failure before the failure can damage data. The corrective actions depend upon the drive group configuration and the type of errors.

Patrol read starts only when the controller is idle for a defined period of time and no other background tasks are active. It can continue to run during heavy I/O processes.

When Patrol Read starts, the progress bar takes some time to display the actual progress. To inform the user that Patrol Read is started, the progress bar displays the progress status as Unknown. The progress bar displays the actual progress once the actual progress status is available.

Disk Striping

Disk striping lets you write data across multiple drives instead of just one drive. Disk striping involves partitioning each drive storage space into stripes. These stripes are interleaved in a repeated sequential manner. The combined storage space is composed of stripes from each drive. Use 64k for drive groups consisting of SSDs and 256k for drive groups consisting of HDDs.

For example, in a four-disk system that uses only disk striping (used in RAID 0), segment 1 is written to disk 1, segment 2 is written to disk 2, and so on. Disk striping enhances performance because multiple drives are accessed simultaneously, but it does not provide data redundancy.

The following figure shows an example of disk striping.

Figure 99: Example of Disk Striping (RAID 0)

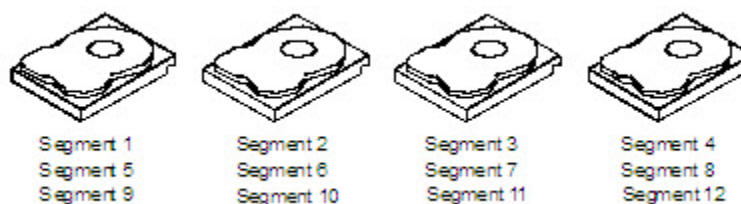

Stripe Width

Stripe width is the number of drives involved in a drive group where striping is implemented. For example, a four-disk drive group with disk striping has a stripe width of four.

Stripe Size

The stripe size is the length of the interleaved data segments that the controller writes across multiple drives, excluding parity drives. Supported stripe sizes are 64k for drive groups consisting of SSDs and 256k for drive groups consisting of HDDs.

Strip Size

The strip size is the portion of a stripe that resides on a single drive.

Disk Mirroring

With disk mirroring (used in RAID 1, RAID 10, PRL-11, and spanned PRL-11), data written to one drive is simultaneously written to another drive. The primary advantage of disk mirroring is that it provides 100-percent data redundancy. Because

the contents of the disk are completely written to a second disk, data is not lost if one disk fails. In addition, both drives contain the same data at all times, so either disk can act as the operational disk. If one disk fails, the contents of the other disk can run the system and reconstruct the failed disk.

The following figure shows an example of disk mirroring.

Figure 100: Example of Disk Mirroring (RAID 1)

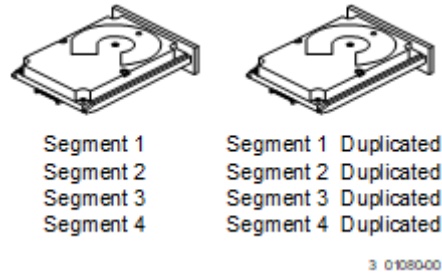

Parity

Parity generates a set of redundancy data from two or more parent data sets. The redundancy data can reconstruct one of the parent data sets in the event of a drive failure. Parity data does not fully duplicate the parent data sets, but parity generation can slow the write process. In RAID, this method is applied to entire drives or stripes across all of the drives in a drive group. The following table describes the types of parity.

Table 22: Types of Parity

Parity Type	Description
Dedicated	The parity data on two or more drives is stored on an additional disk.
Distributed	The parity data is distributed across more than one drive in the system.

RAID 5 combines distributed parity with disk striping. If a single drive fails, it can be rebuilt from the parity and the data on the remaining drives. An example of a RAID 5 drive group is shown in the following figure. RAID 5 uses parity to provide redundancy for one drive failure without duplicating the contents of entire drives. RAID 6 also uses distributed parity and disk striping, but it adds a second set of parity data so that the drive can survive up to two drive failures.

Figure 101: Example of Distributed Parity (RAID 5)

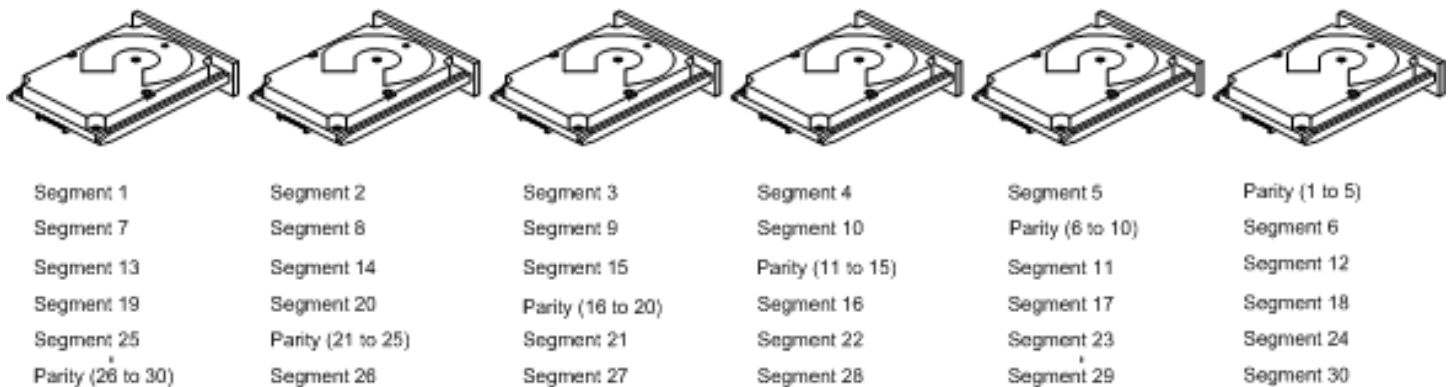

Note: Parity is distributed across all drives in the drive group.

3_01081-00

Disk Spanning

Disk spanning lets multiple drives function like one large drive. Spanning overcomes a lack of disk space and simplifies storage management by combining existing resources or adding relatively inexpensive resources. For example, you can combine four 20-GB drives to appear to the operating system as a single 80-GB drive.

Spanning alone does not provide reliability or performance enhancements. Spanned virtual drives must have the same stripe size and must be contiguous. In the following figure, RAID 1 drive groups are turned into a RAID 10 drive group.

ATTENTION

Even if one span fails, the entire virtual drives will go of line and data will be lost.

Figure 102: Example of Disk Spanning

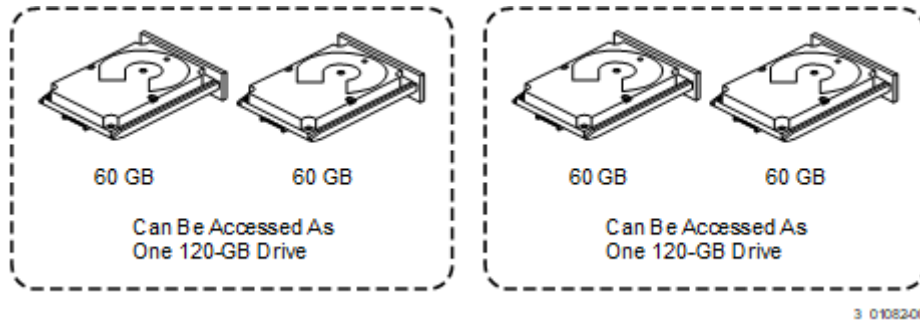

Spanning two contiguous RAID 0 virtual drives does not produce a new RAID level or add fault tolerance. It increases the capacity of the virtual drive and improves performance by doubling the number of spindles.

Spanning for RAID 10, RAID 50, RAID 60, and Spanned PRL-11

The following table describes how to configure RAID 10, RAID 50, RAID 60, and spanned PRL-11 by spanning. The virtual drives must have the same stripe size, and the maximum number of spans is eight. The full drive capacity is used when you span virtual drives; you cannot specify a smaller drive capacity.

Table 23: Spanning for RAID 10, RAID 50, and RAID 60

Level	Description
10	Configure RAID 10 by spanning two contiguous RAID 1 virtual drives, up to the maximum number of supported devices for the controller. RAID 10 supports a maximum of 16 drives (8 spans x 2). You must use an even number of drives in each RAID virtual drive in the span. The RAID 1 virtual drives must have the same stripe size.
50	Configure RAID 50 by spanning two contiguous RAID 5 virtual drives. The RAID 5 virtual drives must have the same stripe size.
60	Configure RAID 60 by spanning two contiguous RAID 6 virtual drives. The RAID 6 virtual drives must have the same stripe size.

NOTE

In a spanned virtual drive (RAID 10, RAID 50, RAID 60, and Spanned PRL-11), the span numbering starts from Span 0, Span 1, Span 2, and so on.

Hot Spares

A hot spare is an extra, unused drive that is part of the disk subsystem. It is usually in Standby mode, ready for service if a drive fails. Hot spares let you replace failed drives without system shutdown or user intervention. The MegaRAID SAS RAID controllers can implement automatic and transparent rebuilds of failed drives using hot spare drives, which provide a high degree of fault tolerance and zero downtime.

The RAID management software lets you specify drives as hot spares. When a hot spare is needed, the RAID controller assigns the hot spare that has a capacity closest to and at least as great as that of the failed drive to take the place of the failed drive. The failed drive is removed from the virtual drive and marked *ready awaiting removal* after the rebuild to a hot spare begins. You can make hot spares of the drives that are not in a RAID virtual drive.

You can use the RAID management software to designate the hot spare to have enclosure affinity, which means that if drive failures are present on a split backplane configuration, the hot spare will be used first on the backplane side in which it resides.

If the hot spare is designated as having enclosure affinity, it tries to rebuild any failed drives on the backplane in which it resides before rebuilding any other drives on other backplanes.

NOTE

If a Rebuild operation to a hot spare fails for any reason, the hot spare drive is marked as *failed*. If the source drive fails, both the source drive and the hot spare drive are marked as *failed*.

The hot spares are of two types:

- Global hot spare
- Dedicated hot spare

Observe the following parameters when using hot spares:

- Hot spares are used only in drive groups with redundancy, which include RAID 1, RAID 5, RAID 6, RAID 10, RAID 50, RAID 60, PRL-11, and Spanned PRL-11 drive groups.
- You must assign the hot spare to one or more drives through the controller BIOS or use drive group management software to place it in the hot spare pool.

Disk Rebuilds

When a drive in a RAID drive group fails, you can rebuild the drive by re-creating the data that was stored on the drive before it failed. The RAID controller re-creates the data using the data stored on the other drives in the drive group. Rebuilding can be done only in drive groups with data redundancy, which include RAID 1, RAID 5, RAID 6, RAID 10, RAID 50, RAID 60, PRL-11, and Spanned PRL-11 drive groups.

The RAID controller uses hot spares to rebuild failed drives automatically and transparently, at user-defined rebuild rates. If a hot spare is available, the rebuild starts automatically when a drive fails. If a hot spare is not available, you must replace the failed drive with a new drive so that the data on the failed drive can be rebuilt.

The failed drive is removed from the virtual drive and marked *ready awaiting removal* when the rebuild to a hot spare starts. If the system goes down during a rebuild, the RAID controller automatically resumes the rebuild after the system reboots.

When the rebuild to a hot spare starts, the failed drive often is removed from the virtual drive before management applications detect the failed drive. When the rebuild occurs, the event logs show the drive rebuilding to the hot spare without showing the failed drive. The formerly failed drive is marked as *ready* after a rebuild starts to a hot spare. If a source drive fails during a rebuild to a hot spare, the rebuild fails and the failed source drive is marked as *offline*. In addition, the rebuilding hot spare drive is changed back to a hot spare. After a rebuild fails, because of a source drive failure, the dedicated hot spare is still dedicated and assigned to the correct drive group, and the global hot spare is still global.

An automatic drive rebuild does not start if you replace a drive during a RAID-level migration. The rebuild must be started manually after the expansion or migration procedure is complete. (RAID-level migration changes a virtual drive from one RAID level to another.)

Rebuild Rate

The rebuild rate is the percentage of the compute cycles dedicated to rebuilding failed drives. A rebuild rate of 100 percent means that the system assigns priority to rebuilding the failed drives.

You can configure the rebuild rate between 0 percent and 100 percent. At 0 percent, the rebuild is done only if the system is not doing anything else. At 100 percent, the rebuild has a higher priority than any other system activity. Using 0 percent or 100 percent is not recommended. The default rebuild rate is accelerated.

Hot Swap

A hot swap manually replaces a defective drive unit when the computer is still running. When a new drive is installed, a rebuild occurs automatically if these situations occur:

- The newly inserted drive is the same capacity as or larger than the failed drive.
- The newly inserted drive is placed in the same drive bay as the failed drive it is replacing.

You can configure the controller to detect the new drives and automatically rebuild the contents of the drive.

Enclosure Management

Enclosure management is the intelligent monitoring of the disk subsystem by software, hardware, or both. The disk subsystem can be part of the host computer or can reside in an external disk enclosure. Enclosure management helps you stay informed of events in the disk subsystem, such as a drive failure or power supply failure. Enclosure management increases the fault tolerance of the disk subsystem.

RAID Levels

The subsequent sections describe the RAID levels in detail.

- [Summary of RAID Levels](#)
- [Selecting a RAID Level](#)
- [RAID 0 Drive Groups](#)
- [RAID 1 Drive Groups](#)
- [RAID 5 Drive Groups](#)
- [RAID 6 Drive Groups](#)
- [RAID 10 Drive Groups](#)
- [RAID 50 Drive Groups](#)
- [RAID 60 Drive Groups](#)

Summary of RAID Levels

RAID 0 uses striping to provide high data throughput, especially for large files in an environment that does not require fault tolerance.

Single drive RAID 0 is suitable for high performance with zero data redundancy. Use single drive RAID 0 for non-critical data.

RAID 1 uses mirroring so that data written to one drive is simultaneously written to another drive. RAID 1 is good for small databases or other applications that require small capacity but complete data redundancy.

RAID 5 uses disk striping and parity data across all drives (distributed parity) to provide high data throughput, especially for small random access.

RAID 6 uses distributed parity, with two independent parity blocks per stripe, and disk striping. A RAID 6 virtual drive can survive the loss of any two drives without losing data. A RAID 6 drive group, which requires a minimum of three drives, is similar to a RAID 5 drive group. Blocks of data and parity information are written across all drives. The parity information recovers the data if one or two drives fail in the drive group.

RAID 10, a combination of RAID 0 and RAID 1, contains striped data across mirrored spans. A RAID 10 drive group is a spanned drive group that creates a striped set from a series of mirrored drives. RAID 10 allows a maximum of eight spans. You must use an even number of drives in each RAID virtual drive in the span. The RAID 1 virtual drives must have the same stripe size. RAID 10 provides high data throughput and complete data redundancy, but it uses a larger number of spans.

RAID 50, a combination of RAID 0 and RAID 5, uses distributed parity and disk striping. A RAID 50 drive group is a spanned drive group in which data is striped across multiple RAID 5 drive groups.

NOTE

Having virtual drives of different RAID levels, such as RAID 0 and RAID 5, in the same drive group is not allowed. For example, if an existing RAID 5 virtual drive is created out of partial space in an array, the next virtual drive in the array must be RAID 5.

RAID 60, a combination of RAID 0 and RAID 6, uses distributed parity, with two independent parity blocks per stripe in each RAID set, and disk striping. A RAID 60 virtual drive can survive the loss of two drives in each of the RAID 6 sets without losing data.

NOTE

RAID 50 and RAID 60 work best with data that requires high reliability, high request rates, high data transfers, and medium-to-large capacity.

Selecting a RAID Level

To make sure of the best performance, you must choose the optimal RAID level when you create a system drive. The optimal RAID level for your drive group depends on a number of factors:

- The number of drives in the drive group
- The capacity of the drives in the drive group
- The need for data redundancy
- The disk performance requirements

RAID 0 Drive Groups

RAID 0 provides disk striping across all drives in the RAID drive group. RAID 0 does not provide any data redundancy, but it offers the best performance of any RAID level. RAID 0 breaks up data into smaller segments, and then stripes the data segments across each drive in the drive group. The size of each data segment is determined by the stripe size. RAID 0 offers high bandwidth.

A single drive RAID 0 has the same functions as RAID 0, but is created using a single drive.

NOTE

RAID level 0 is not fault tolerant. If any drive in a RAID 0 drive group fails, the entire virtual drive (all of the VDs associated with the drive group) fails.

RAID 0 does not perform parity calculations to complicate the write operation. This situation makes RAID 0 ideal for applications that require high bandwidth but do not require fault tolerance. The following table provides an overview of RAID 0. The following figure shows an example of a RAID 0 drive group.

Table 24: RAID 0 Overview

Uses	Provides high data throughput, especially for large files. Use it for any environment that does not require fault tolerance. Use single drive RAID 0 for non-critical data.
Strong points	Provides increased data throughput for large files. No capacity loss penalty for parity. Single drive RAID 0 is suitable for high performance with zero data redundancy.
Weak points	Does not provide fault tolerance or high bandwidth. All data is lost if any drive fails.
Drives	1 to 32.

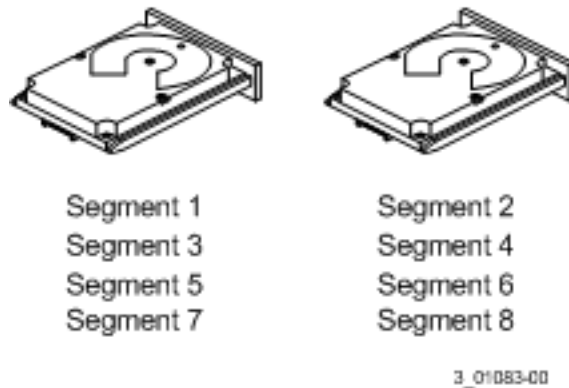
Figure 103: RAID 0 Drive Group Example with Two Drives

RAID 1 Drive Groups

In RAID 1, the controller card duplicates all of the data from one drive to a second drive in the drive group. RAID 1 supports an even number of drives from two through eight in a single span. RAID 1 provides complete data redundancy, but at the cost of doubling the required data storage capacity. The following table provides an overview of RAID 1. The following figure shows an example of a RAID 1 drive group.

Table 25: RAID 1 Overview

Uses	Use RAID 1 for small databases or any other environment that requires fault tolerance but small capacity.
Strong points	Provides complete data redundancy. RAID 1 is ideal for any application that requires fault tolerance and minimal capacity.
Weak points	Requires twice as many drives. Performance is impaired during drive rebuilds.
Drives	2

Figure 104: RAID 1 Drive Group

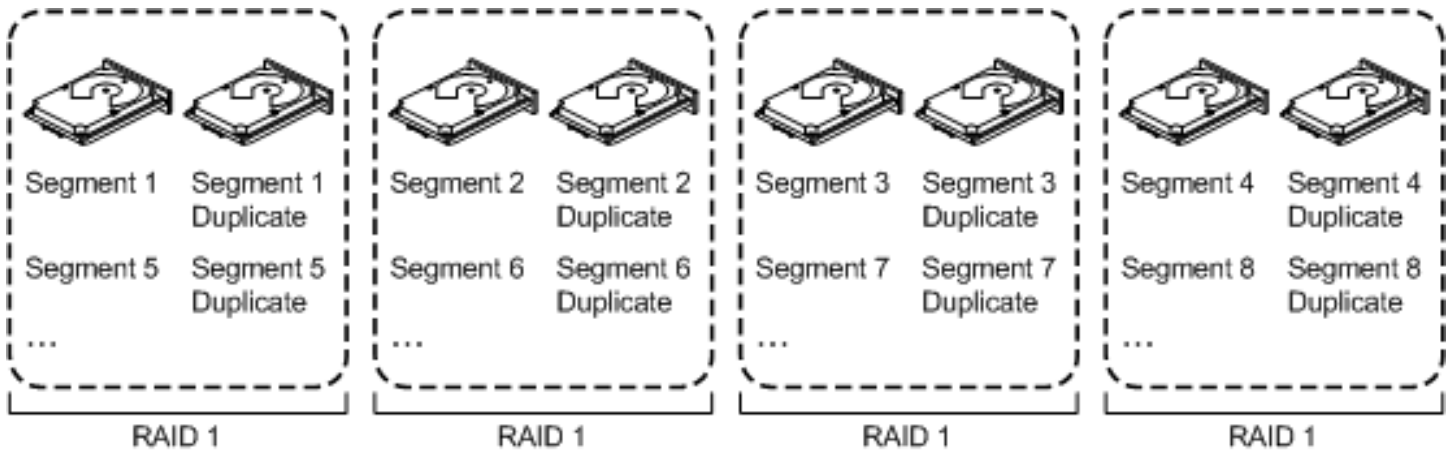

3_01084-00

RAID 5 Drive Groups

RAID 5 includes disk striping at the block level and parity. Parity is the data’s property of being odd or even, and parity checking detects errors in the data. In RAID 5, the parity information is written to all drives. RAID 5 is best suited for networks that perform many small I/O transactions simultaneously.

RAID 5 addresses the bottleneck issue for random I/O operations. Because each drive contains both data and parity, numerous writes can take place concurrently.

The following table provides an overview of RAID 5. The following figure shows an example of a RAID 5 drive group.

Table 26: RAID 5 Overview

Uses	Provides high data throughput, especially for large files. Use RAID 5 for transaction-processing applications because each drive can read and write independently. If a drive fails, the controller card uses the parity drive to re-create all missing information. Also use it for office automation and online customer service that requires fault tolerance. Use it for any application that has high read request rates but low write request rates.
Strong points	Provides data redundancy, high read rates, and good performance in most environments. Provides redundancy with the lowest loss of capacity.
Weak points	Not well suited to tasks requiring lots of small writes or small block write operations. Suffers more impact if no cache is used. Drive performance is reduced if a drive is being rebuilt. Environments with few processes do not perform as well because the RAID drive group overhead is not offset by the performance gains in handling simultaneous processes.
Drives	3 through 32.

Figure 105: RAID 5 Drive Group with Six Drives

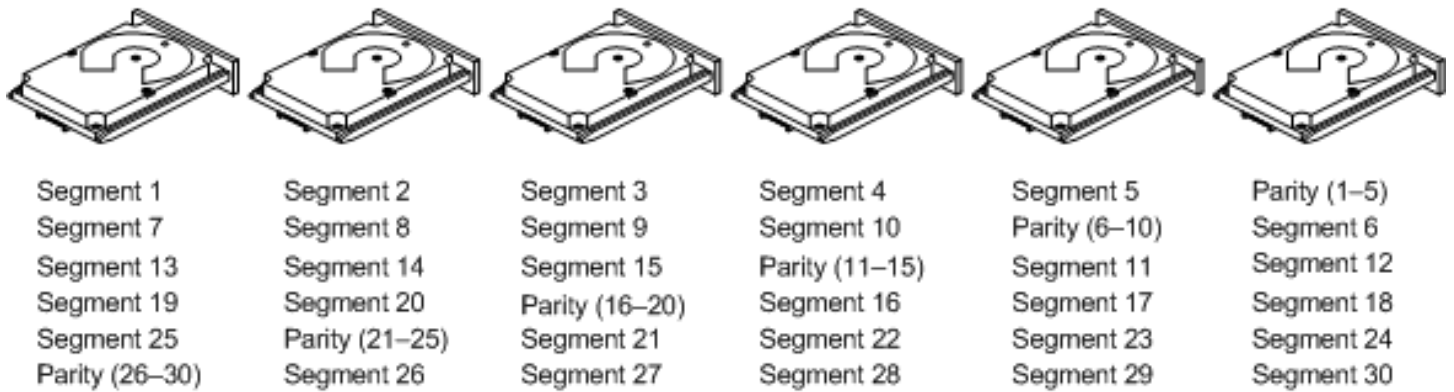

Note: Parity is distributed across all drives in the drive group.

3_01085-00

RAID 6 Drive Groups

RAID 6 is similar to RAID 5 (disk striping and parity), except that instead of one parity block per stripe, RAID 6 uses two. With two independent parity blocks, RAID 6 can survive the loss of any two drives in a virtual drive without losing data. RAID 6 provides a high level of data protection through a second parity block in each stripe. Use RAID 6 for data that requires a very high level of protection from loss.

In the case of a failure of one drive or two drives in a virtual drive, the controller uses the parity blocks to re-create all of the missing information. If two drives in a RAID 6 virtual drive fail, two drive rebuilds are required, one for each drive. These rebuilds do not occur at the same time. The controller rebuilds one failed drive, and then the other failed drive.

The following table provides an overview of a RAID 6 drive group.

Table 27: RAID 6 Overview

Uses	RAID 6 for office automation and online customer service that requires fault tolerance. Use it for any application that has high read request rates but low write request rates.
Strong points	Provides data redundancy, high read rates, and good performance in most environments. Can survive the loss of two drives or the loss of a drive while another drive is being rebuilt. Provides the highest level of protection against drive failures of all of the RAID levels. The read performance is similar to that of RAID 5.
Weak points	Not well-suited to tasks requiring a lot of small and/or random write operations. A RAID 6 virtual drive must generate two sets of parity data for each write operation, which results in a significant decrease in performance during write operations. Drive performance is reduced during a drive Rebuild operation. Environments with few processes do not perform as well because the RAID overhead is not offset by the performance gains in handling simultaneous processes. A RAID 6 drive group costs more because of the extra capacity required by using two parity blocks per stripe.
Drives	4 through 32.

The following figure shows a RAID 6 data layout. The second set of parity drives is denoted by Q. The P drives follow the RAID 5 parity scheme.

Figure 106: Distributed Parity across Two Blocks in a Stripe (RAID 6)

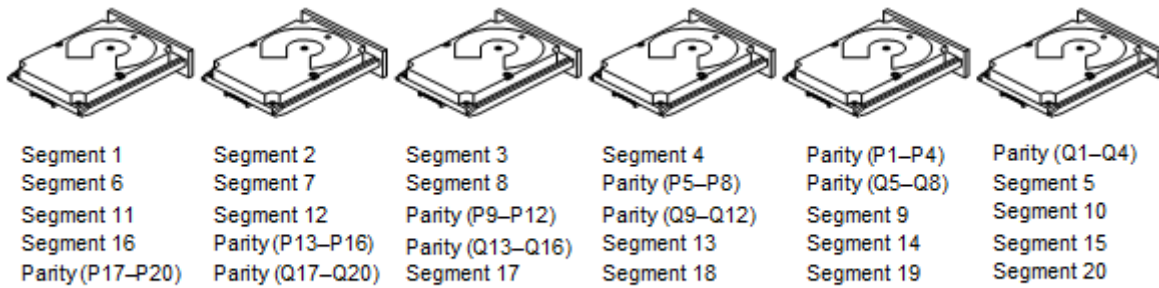

Note: Parity is distributed across all drives in the drive group.

3 0108600

RAID 10 Drive Groups

RAID 10 is a combination of RAID 0 and RAID 1, and it consists of stripes across mirrored drives. RAID 10 breaks up data into smaller blocks and mirrors the blocks of data to each RAID 1 drive group. The first RAID 1 drive in each drive group then duplicates its data to the second drive. The stripe size parameter determines the size of each block, which is set during the creation of the RAID set. The RAID 1 virtual drives must have the same stripe size.

Spanning is used because one virtual drive is defined across more than one drive group. Virtual drives defined across multiple RAID 1 level drive groups are referred to as RAID 10 (RAID 1 + RAID 0). Data is striped across drive groups to increase performance by enabling access to multiple drive groups simultaneously.

Each spanned RAID 10 virtual drive can tolerate a single drive failure. If drive failures occur, less than the total drive capacity is available.

Configure RAID 10 by spanning two contiguous RAID 1 virtual drives, up to the maximum number of supported devices for the controller. RAID 10 supports a maximum of eight spans, with a maximum of two drives per span. You must use an even number of drives in each RAID 10 virtual drive in the span.

NOTE

Other factors, such as the type of controller, can restrict the number of drives supported by RAID 10 virtual drives.

For 2-32 drives, a single span R1 is required. Multiple span RAID 10 configurations are used for 36 drives and larger configurations.

The following table provides an overview of RAID 10.

Table 28: RAID 10 Overview

Uses	Appropriate when used with data storage that needs 100-percent redundancy of mirrored drive groups and that also needs the enhanced I/O performance of RAID 0 (striped drive groups). RAID 10 works well for medium-sized databases or any environment that requires a higher degree of fault tolerance and moderate-to-medium capacity.
Strong points	Provides both high data transfer rates and complete data redundancy.
Weak points	Requires twice as many drives as all other RAID levels except in RAID 1 drive groups.
Drives	36 to 240 – The number of drives in each span must be an even number, and the same number of drivers in each span. The maximum number of drives supported by the controller (using an even number of drives in each RAID 10 virtual drive in the span). The MegaRAID controller supports 16 drives.

In the following figure, virtual drive 0 is created by distributing data across four drive groups (drive groups 0 through 3).

Figure 107: RAID 10 Level Virtual Drive

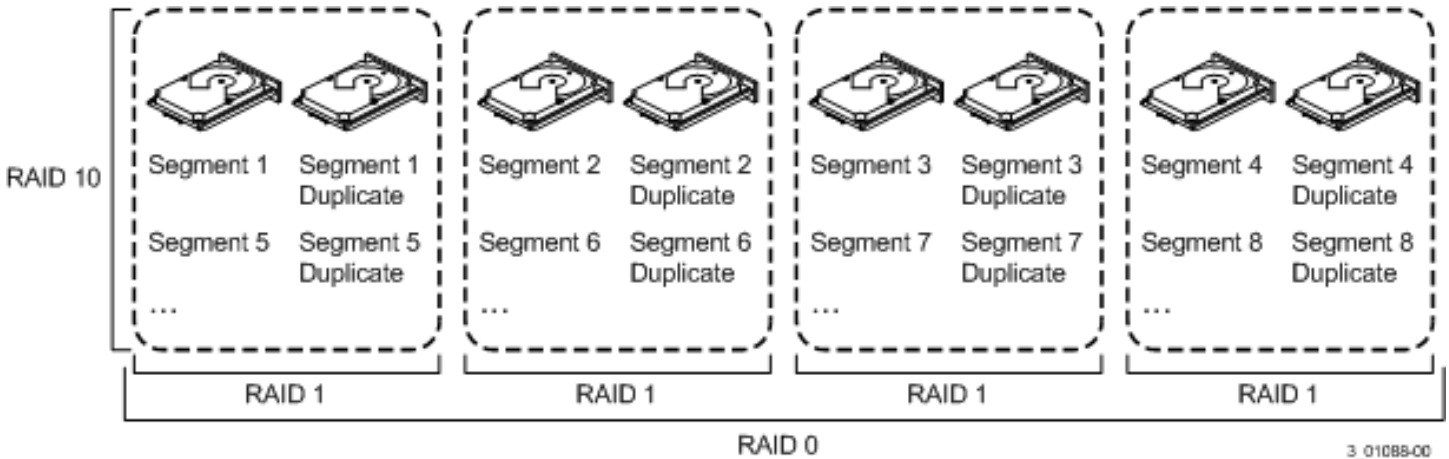

RAID 50 Drive Groups

RAID 50 provides the features of both RAID 0 and RAID 5. RAID 50 includes both distributed parity and drive striping across multiple drive groups. RAID 50 is best implemented on two RAID 5 drive groups with data striped across both drive groups.

RAID 50 breaks up data into smaller blocks and then stripes the blocks of data to each RAID 5 disk set. RAID 5 breaks up data into smaller blocks, calculates parity by performing an exclusive OR operation on the blocks, and then writes the blocks of data and parity to each drive in the drive group. The stripe size parameter determines the size of each block, which is set during the creation of the RAID set.

RAID 50 supports up to eight spans and tolerates up to eight drive failures, though less than the total drive capacity is available. Though multiple drive failures can be tolerated, each RAID 5 drive group can tolerate only one drive failure.

The following table provides an overview of RAID 50.

Table 29: RAID 50 Overview

Uses	Appropriate when used with data that requires high reliability, high request rates, high data transfer, and medium-to-large capacity.
Strong points	Provides high data throughput, data redundancy, and very good performance.
Weak points	Requires two times to eight times as many parity drives as RAID 5.
Drives	A minimum of two spans of three drives per span, up to eight spans of 3 to 32 drives per span (limited by the maximum number of drives supported by the controller). Each span must contain the same number of drives. Eight spans of RAID 5 drive groups that contain 3 to 32 drives each (limited by the maximum number of devices supported by the controller).

Figure 108: RAID 50 Level Virtual Drive

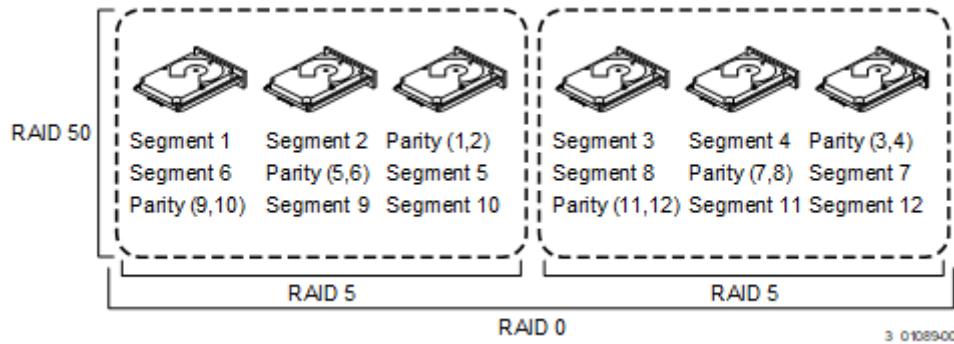

RAID 60 Drive Groups

RAID 60 provides the features of both RAID 0 and RAID 6 and includes both distributed parity and drive striping across multiple drive groups. RAID 6 supports two independent parity blocks per stripe. A RAID 60 virtual drive can survive the loss of two drives in each of the RAID 6 sets without losing data. RAID 60 is best implemented on two RAID 6 drive groups with data striped across both drive groups.

RAID 6 breaks up data into smaller blocks, calculates parity by performing an exclusive OR operation on the blocks, and then writes the blocks of data and parity to each drive in the drive group. The stripe size parameter determines the size of each block, which is set during the creation of the RAID set.

RAID 60 supports up to eight spans and tolerates up to 16 drive failures, though less than the total drive capacity is available. Each RAID 6 level drive group can tolerate two drive failures.

Table 30: RAID 60 Overview

Uses	<p>Provides a high level of data protection through the use of a second parity block in each stripe. Use RAID 60 for data that requires a very high level of protection from loss.</p> <p>In the case of a failure of one drive or two drives in a RAID set in a virtual drive, the controller card uses the parity blocks to re-create all of the missing information. If two drives in a RAID 6 set in a RAID 60 virtual drive fail, two drive rebuilds are required, one for each drive. These rebuilds can occur at the same time.</p> <p>Use RAID 60 for office automation and online customer service that require fault tolerance. Use it for any application that has high read request rates but low write request rates.</p>
Strong points	<p>Provides data redundancy, high read rates, and good performance in most environments. Each RAID 60 set can survive the loss of two drives or the loss of a drive while another drive is being rebuilt. Provides the highest level of protection against drive failures of all of the RAID levels. Read performance is similar to that of RAID 50, though random reads in RAID 60 might be slightly faster because data is spread across at least one more disk in each RAID 60 set.</p>
Weak points	<p>Not well-suited to tasks requiring lot of writes. A RAID 60 virtual drive must generate two sets of parity data for each write operation, which results in a significant decrease in performance during writes.</p> <p>Drive performance is reduced during a drive rebuild. Environments with few processes do not perform as well because the RAID overhead is not offset by the performance gains in handling simultaneous processes.</p> <p>A RAID 60 drive group costs more because of the extra capacity required by using two parity blocks per stripe.</p>
Drives	<p>Eight spans of RAID 6 drive groups that contain 4 to 32 drives each (limited by the maximum number of devices supported by the controller).</p>

The following figure shows a RAID 60 data layout. The second set of parity drives is denoted by *Q*. The *P* drives follow the RAID 60 parity scheme.

Figure 109: RAID 60 Level Virtual Drive

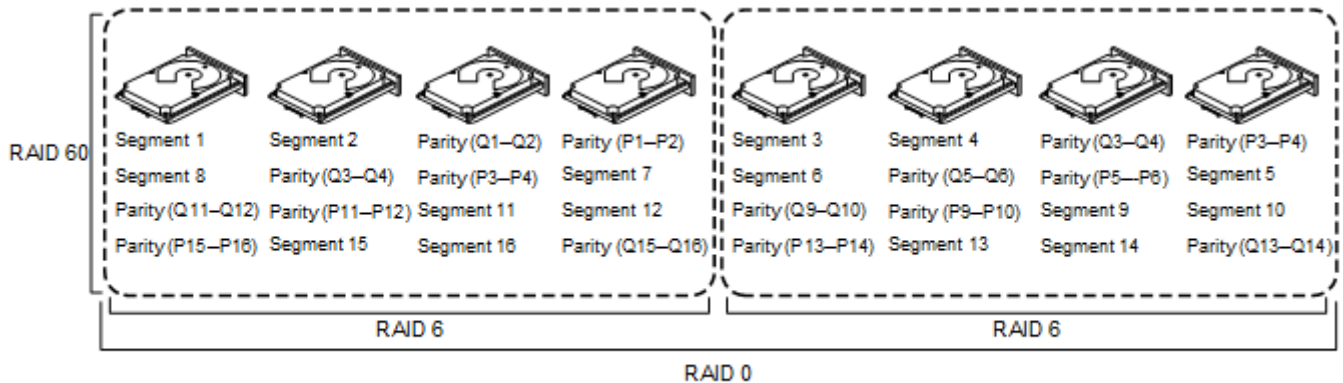

Note: Parity is distributed across all drives in the drive group.

3 01090-00

RAID Configuration Strategies

The following factors in RAID drive group configuration are most important:

- Virtual drive availability (fault tolerance)
- Virtual drive performance
- Virtual drive capacity

You cannot configure a virtual drive that optimizes all three factors, but it is easy to choose a virtual drive configuration that maximizes one factor at the expense of another factor. For example, RAID 1 (mirroring) provides excellent fault tolerance, but it requires a redundant drive.

The following subsections describe how to use the RAID levels to maximize virtual drive availability (fault tolerance), virtual drive performance, and virtual drive capacity.

Maximizing Fault Tolerance

Fault tolerance is achieved through the ability to perform automatic and transparent rebuilds using hot spare drives and hot swaps. A hot spare drive is an unused online available drive that the controller card instantly plugs into the system when an active drive fails. After the hot spare is automatically moved into the RAID drive group, the failed drive is automatically rebuilt on the spare drive. The RAID drive group continues to handle requests while the rebuild occurs.

A hot swap is the manual substitution of a replacement unit in a disk subsystem for a defective one, where the substitution can be performed while the subsystem is running hot swap drives. Auto-Rebuild in the WebBIOS Configuration Utility allows a failed drive to be replaced and automatically rebuilt by *hot-swapping* the drive in the same drive bay. The RAID drive group continues to handle requests while the rebuild occurs, providing a high degree of fault tolerance and zero downtime.

Table 31: RAID Levels and Fault Tolerance

RAID Level	Fault Tolerance
0	Does not provide fault tolerance. All data is lost if any drive fails. Disk striping writes data across multiple drives instead of just one drive. It involves partitioning each drive storage space into stripes that can vary in size. RAID 0 is ideal for applications that require high performance but do not require fault tolerance.
1	Provides complete data redundancy. If one drive fails, the contents of the other drive in the drive group can be used to run the system and reconstruct the failed drive. The primary advantage of disk mirroring is that it provides 100 percent data redundancy. Because the contents of the drive are completely written to a second drive, no data is lost if one of the drives fails. Both drives contain the same data at all times. RAID 1 is ideal for any application that requires fault tolerance and minimal capacity.
5	Combines distributed parity with disk striping. Parity provides redundancy for one drive failure without duplicating the contents of entire drives. If a drive fails, the controller card uses the parity data to reconstruct all missing information. In RAID 5, this method is applied to entire drives or stripes across all drives in a drive group. Using distributed parity, RAID 5 offers fault tolerance with limited overhead.
6	Combines distributed parity with disk striping. RAID 6 can sustain two drive failures and still maintain data integrity. Parity provides redundancy for two drive failures without duplicating the contents of entire drives. If a drive fails, the controller card uses the parity data to reconstruct all missing information. In RAID 6, this method is applied to entire drives or stripes across all of the drives in a drive group. Using distributed parity, RAID 6 offers fault tolerance with limited overhead.
10	Provides complete data redundancy using striping across spanned RAID 1 drive groups. RAID 10 works well for any environment that requires the 100 percent redundancy offered by mirrored drive groups. RAID 10 can sustain a drive failure in each mirrored drive group and maintain data integrity.
50	Provides data redundancy using distributed parity across spanned RAID 5 drive groups. RAID 50 includes both parity and disk striping across multiple drives. If a drive fails, the controller card uses the parity data to re-create all missing information. RAID 50 can sustain one drive failure per RAID 5 drive group and still maintain data integrity.
60	Provides data redundancy using distributed parity across spanned RAID 6 drive groups. RAID 60 can sustain two drive failures per RAID 6 drive group and still maintain data integrity. It provides the highest level of protection against drive failures of all of the RAID levels. RAID 60 includes both parity and disk striping across multiple drives. If a drive fails, the controller card uses the parity data to re-create all missing information.

Maximizing Performance

A RAID disk subsystem improves I/O performance. The RAID drive group appears to the host computer as a single storage unit or as multiple virtual units. I/O is faster because drives can be accessed simultaneously. The following table describes the performance for each RAID level.

Table 32: RAID Levels and Performance

RAID Level	Performance
0	RAID 0 (striping) offers excellent performance. RAID 0 breaks up data into smaller blocks and then writes a block to each drive in the drive group. Disk striping writes data across multiple drives instead of just one drive. RAID 0 partitions each drive's storage space into stripes that can vary in size from 64 KiB to 256 KiB. These stripes are interleaved in a repeated sequential manner. Disk striping enhances performance because multiple drives are accessed simultaneously.
1	With RAID 1 (mirroring), each drive in the system must be duplicated, which requires more time and resources than striping. Performance is impaired during drive rebuilds.

RAID Level	Performance
5	RAID 5 provides high data throughput, especially for large files. Use this RAID level for any application that requires high read request rates, but low write request rates, such as transaction processing applications, because each drive can read and write independently. Because each drive contains both data and parity, numerous writes can take place concurrently. In addition, robust caching algorithms and hardware-based exclusive-or assist make RAID 5 performance exceptional in many different environments. Parity generation can slow the write process, which makes write performance significantly lower for RAID 5 than for RAID 0 or RAID 1. Drive performance is reduced when a drive is being rebuilt. Clustering also can reduce drive performance. Environments with few processes do not perform as well because the RAID overhead is not offset by the performance gains in handling simultaneous processes.
6	RAID 6 works best when used with data that requires high reliability, high request rates, and high data transfer. It provides high data throughput, data redundancy, and very good performance. However, RAID 6 is not well-suited to that requires many writes. A RAID 6 virtual drive must generate two sets of parity data for each write operation, which results in a significant decrease in performance during writes. Drive performance is reduced during a drive rebuild. Environments with few processes do not perform as well because the RAID overhead is not offset by the performance gains in handling simultaneous processes.
10	RAID 10 works best for data storage that needs the enhanced I/O performance of RAID 0 (striped drive groups), which provides high data transfer rates. Spanning increases the capacity of the virtual drive and improves performance by doubling the number of spindles. The system performance improves as the number of spans increases. (The maximum number of spans is 8.) As the storage space in the spans is filled, the system stripes data over fewer and fewer spans, and RAID performance degrades to that of a RAID 1 or RAID 5 drive group.
50	RAID 50 works best when used with data that requires high reliability, high request rates, and high data transfer. It provides high data throughput, data redundancy, and very good performance. Spanning increases the capacity of the virtual drive and improves performance by doubling the number of spindles. The system performance improves as the number of spans increases. (The maximum number of spans is eight.) As the storage space in the spans is filled, the system stripes data over fewer and fewer spans, and RAID performance degrades to that of a RAID 1 or RAID 5 drive group.
60	RAID 60 works best when used with data that requires high reliability, high request rates, and high data transfer. It provides high data throughput, data redundancy, and very good performance. Spanning increases the capacity of the virtual drive and improves performance by doubling the number of spindles. The system performance improves as the number of spans increases. (The maximum number of spans is 8.) As the storage space in the spans is filled, the system stripes data over fewer and fewer spans, and RAID performance degrades to that of a RAID 1 or RAID 6 drive group. RAID 60 is not well suited to tasks that requires many writes. A RAID 60 virtual drive must generate two sets of parity data for each write operation, which results in a significant decrease in performance during writes. Drive performance is reduced during a drive rebuild. Environments with few processes do not perform as well because the RAID overhead is not offset by the performance gains in handling simultaneous processes.

Maximizing Storage Capacity

Storage capacity is an important factor when selecting a RAID level. Consider several variables to consider. Striping alone (RAID 0) requires less storage space than mirrored data (RAID 1) or distributed parity RAID 5. The following table explains the effects of the RAID level on storage capacity.

Table 33: RAID Levels and Capacity

RAID Level	Capacity
0	RAID 0 (striping) partitions each drive's storage space into stripes that can vary in size. The combined storage space is composed of stripes from each drive. A RAID 0 drive group provides maximum storage capacity for a given set of drives. The usable capacity of a RAID 0 array is equal to the number of drives in the array into the capacity of the smallest drive in the array.
1	With RAID 1 (mirroring), data written to one drive is simultaneously written to another drive, which doubles the required data storage capacity. This situation is expensive because each drive in the system must be duplicated. The usable capacity of a RAID 1 array is equal to the capacity of the smaller of the two drives in the array.

RAID Level	Capacity
5	RAID 5 provides redundancy for one drive failure without duplicating the contents of entire drives. RAID 5 breaks up data into smaller blocks, calculates parity by performing an exclusive-or on the blocks and then writes the blocks of data and parity to each drive in the drive group. The size of each block is determined by the stripe size parameter, which is set during the creation of the RAID set. The usable capacity of a RAID 5 array is equal to the number of drives in the array, minus one, into the capacity of the smallest drive in the array.
6	RAID 6 provides redundancy for two drive failures without duplicating the contents of entire drives. However, it requires extra capacity because it uses two parity blocks per stripe, which makes RAID 60 more expensive to implement. The usable capacity of a RAID 6 array is equal to the number of drives in the array, minus two, into the capacity of the smallest drive in the array.
10	RAID 10 requires twice as many drives as all other RAID levels except RAID 1. RAID 10 works well for medium-sized databases or any environment that requires a higher degree of fault tolerance and moderate-to-medium capacity. Disk spanning lets multiple drives function like one large drive. Spanning overcomes the lack of disk space and simplifies storage management by combining existing resources or adding relatively inexpensive resources.
50	RAID 50 requires two to four times as many parity drives as RAID 5. This RAID level works best when used with data that requires medium to large capacity.
60	RAID 60 provides redundancy for two drive failures in each RAID set without duplicating the contents of entire drives. However, it requires extra capacity because a RAID 60 virtual drive must generate two sets of parity data for each write operation. This situation makes RAID 60 more expensive to implement.

RAID Availability

Data availability without downtime is essential for many types of data processing and storage systems.

Businesses want to avoid the financial costs and customer frustration that are associated with failed servers.

The RAID technology helps you maintain data availability and avoid downtime for the servers that provide that data. RAID offers several features, such as spare drives and rebuilds, that you can use to fix any drive problems, while keeping the servers running and data available. The following subsections describe these features.

RAID Availability Concepts

Spare Drives

You can use spare drives to replace failed drives or defective drives in a drive group. A replacement drive must be at least as large as the drive it replaces. Spare drives include hot swaps, hot spares, and cold swaps.

A hot swap is the manual substitution of a replacement unit in a disk subsystem for a defective one, where the substitution can be performed while the subsystem is running (performing its normal functions). The backplane and enclosure must support hot swap for the functionality to work.

Hot spare drives are drives that power up along with the RAID drives and operate in a Standby state. If a drive used in a RAID virtual drive fails, a hot spare automatically takes its place, and the data on the failed drive is rebuilt on the hot spare. Hot spares can be used for RAID 1, RAID 5, RAID 6, RAID 10, RAID 50, RAID 60, PRL-11, and Spanned PRL-11.

NOTE

If a rebuild to a hot spare fails for any reason, the hot spare drive is marked as *failed*. If the source drive fails, both the source drive and the hot spare drive are marked as *failed*.

A cold swap requires that you power down the system before replacing a defective drive in a disk subsystem.

Rebuilding

If a drive fails in a drive group that is configured as a RAID 1, RAID 5, RAID 6, RAID 10, RAID 50, RAID 60, PRL-11, or Spanned PRL-11 virtual drive, you can recover the lost data by rebuilding the drive. If you have configured hot spares, the controller card automatically tries to use them to rebuild failed drives. Manual rebuild is necessary if hot spares with enough capacity to rebuild the failed drives are not available. You must insert a drive with enough storage into the subsystem before rebuilding the failed drive.

Configuration Planning

The factors to consider when planning a configuration are the number of drives that the controller card can support, the purpose of the drive group, and the availability of spare drives.

Each type of the data stored in the disk subsystem has a different frequency of read and write activity. If you know the data access requirements, you can determine a strategy for optimizing the disk subsystem capacity, availability, and performance.

The servers that support video-on-demand typically read the data often but write data infrequently. Both the read and write operations tend to be long. Data stored on a general-purpose file server involves relatively short read and write operations with relatively small files.

Possible Raid Levels

While creating a new storage configuration, depending on the personality mode, LSI Storage Authority software displays the following possible RAID levels for that personality mode.

JBOD Mode:

The possible RAID levels in JBOD mode are:

- RAID 0
- RAID 1
- RAID 10
- PRL-11
- Spanned PRL-11

RAID Mode:

The possible RAID levels in RAID mode are the default RAID levels supported by the firmware.

None Mode:

- RAID 0
- RAID 1
- RAID 5
- RAID 6
- RAID 10
- RAID 50
- RAID 60
- PRL-11
- Spanned PRL-11

Events and Messages

This section lists the events and messages that appear in the event log.

The LSI Storage Authority software monitors the activity and performance of all of the controllers in the workstation and the devices attached to them. When an event occurs, such as the start of an initialization, an event message appears in the log at the bottom of the Server dashboard or Controller dashboard. The messages are also logged in the Windows Application log (Event Viewer).

Error Levels

Each message that appears in the event log has a Severity level that indicates the severity of the event, as shown in the following table.

Table 34: Event Error Levels

Severity Level	Meaning
Information	Informational message. No user action is necessary.
Warning	Some component might be close to a failure point.
Critical	A component has failed, but the system has not lost data.
Fatal	A component has failed, and data loss has occurred or will occur.

HTTP Status Codes and Description

This section describes the meaning of the HTTP status codes.

HTTP status codes notify you about the status of the request made.

Table 35: HTTP Status Codes

Code	Description	Example
200 OK	The request was successfully completed and includes a representation in its body (if applicable). Usually, this is the code that the client hopes to see. It indicates that the server successfully carried out whatever action the client requested. Also use for partial success, for example, few of the controller fields are updated (by checking read-modify-write-read) process.	GET /servers/{id}/controllers PUT/servers/{id}/controllers/1 PUT/servers/{id}/controllers/1/ virtualdrives/0
201 Created	A request that created a new resource completed successfully.	POST/servers/{id}/controllers/1/ virtualdrives
301 Moved Permanently	The requested resource resides under a different URI.	
302 Found	The requested resource resides temporarily under a different URI.	
400 Bad Request	The request could not be processed because it contains missing or invalid information (such as validation error on an input field, a missing required value, and so on). In general, either the request body is not valid against schema or semantical error in request.	PUT/servers/{id}/controllers/1 with {"nonExistantAttribute": "0"} Try to run a consistency check on RAID 0 virtual drive. The status code is MFI_STAT if coming from firmware.
401 Unauthorized	The authentication credentials are missing or invalid.	GET /servers/{id}/controllers# Run before authentication.
403 Forbidden	The server recognized the credentials in the request, but those credentials do not possess authorization to perform this request. For example, a read-only user is trying to create a configuration.	POST /servers/{id}/controllers/1/ virtualdrives For a read-only user.
404 Not Found	The request specified a URI of a resource that does not exist. The server has not found anything matching the Request-URI. No indication is given of whether the condition is temporary or permanent.	GET /servers/{id}/controlers/0 GET /servers/{id}/controllers/99 When there is no controller with ID 99.
405 Method Not Allowed	The URI is valid but the HTTP verb that is specified in the request (for example, DELETE, GET, POST, PUT) is not supported for this request URI.	POST /servers/{id}/controllers
410 Gone	The requested resource is no longer available at the server and no forwarding address is known. This condition is expected to be considered permanent.	Client wants to download a log (for example, the TTY log) but the file is being deleted and no longer available (and will never be available).
422 Unprocessable Entity	Semantical error (see status code 400 for details).	Try to run consistency check on RAID 0 virtual drive.

Code	Description	Example
500 Internal Server Error	The server encountered an unexpected condition that prevented it from fulfilling the request.	Most of the cases it is a defect or an error in backend itself, for example, memory allocation error, or initialization error, and so on.
501 Not Implemented	Implies future availability. The current server lacks the ability to fulfill the request.	None so far.

SAS Address Assignment Rule

This section provides information on how to calculate the PHY SAS address.

The PHY SAS address is calculated by incrementing the controller SAS address by one, based on the number of PHYs.

Suppose you are using 16 or 8 PHY cards and four connectors exist: C3, C2, C1, and C0. Each connector has four PHYs, and the autoport configuration is always enabled. Connector C3 has PHYs 0 through 3, Connector C2 has PHYs 4 through 7, Connector C1 has PHYs 8 through 11, and Connector C0 has PHYs 12 through 15.

- If you are connecting four different target devices and want to plug a cable into Connector 1, the SAS address for this port is 0x5000_0000_8000_0008 because the connector's first PHY is 8.
- Furthermore, when you plug a cable into Connector 0, the SAS address for this port is 0x5000_0000_8000_0009.
- Assuming nothing is connected to the HBA and you plug a cable into Connector 0, the SAS address that is assigned to this port is 0x5000_0000_8000_0008.
- Again, assuming nothing is connected to the HBA and you plug a cable into Connector 3, the SAS address that is assigned to this port is 0x5000_0000_8000_0000.
- Next, when a cable is plugged into Connector 2, the SAS address that is assigned to this port is 0x5000_0000_8000_0001.

This logic is also applicable for cards with eight PHYs.

Controllers have two SAS cores; each core can have a wide port, with at the most x8 connections. While connectors C0 and C1 can belong to one core, connectors C2 and C3 can belong to another core.

Multi-Selection Threshold for Virtual and Physical Drives

The section provides information for selecting additional drives.

While selecting virtual drives or physical drives, you can only select up to 32 VDs or 32 PDs.

If you want to select more than 32 VDs or PDs, perform the following steps:

1. Navigate to the directory `\LSIStorageAuthority\server\html\files`
2. Open the `Configfile.json` file.
3. In the `Configfile.json` file, search for the `maxVDs` field.
The `maxVDs` field is set by default to a value of 32 to accept 32 VDs/PDs.
4. Modify this value to 64 .
5. Clear your browser's history.

Now, you can select more than 32 VDs or PDs, up to a maximum of 64 VDs or PDs.

Known Issues and Workarounds

The section contains a list of known issues and workarounds.

- **Issue:** The desktop shortcut is linked with a batch file. If the Windows User Account Control (UAC) is enabled, the privilege escalation prompt is not presented for users who have administrative privileges, but not administrator resulting in access denied message.
Workaround: Enter the LSA URL, `localhost:port` directly into the browser
- **Issue:** A repurposed event occurs.
Workaround: Restart the LSA service.
- **Issue:** By default, the controller will not be loaded or unloaded in LSA when the user enables or disables the controller.
Workaround: Restart the LSA service to retrieve the updated controller list.
- **Issue:** When user enables or disables the controller, the controller will not be loaded or unloaded in LSA by default.
Workaround: Restart the LSA service to retrieve the updated controller list.
- **Issue:** When heavy IOs are active, LSA will be slow and may see stale data.
Workaround: Refresh the browser or restart the LSA service to retrieve the updated data.
- **Issue:** When the dedicated hot spare limit is exceeded, LSA continues to show the operation, but fails the operation with a corresponding error message.
Workaround: None.
- **Issue:** PSoC image flashing is not supported through LSA for IT.
Workaround: Use StorCLI to update the PSOC image. You can see the update in LSA properties.
- **Issue:** When multiple controllers are installed in a system and one controller enters a fault state, the controller ID populated by LSA may be different from other applications.
Workaround: Restart the LSA services.
- **Issue:** Light Weight Agent allows only two snapdump files to be downloaded at a time.
Workaround: None.
- **Issue:** An IR/IT firmware downgrade is not supported from one phase to another phase due to limitations in underlying layers.
Workaround: None.
- **Issue:** LSA does not detect all the controllers in a HyperV environment when the controller passthrough is enabled or disabled.
Workaround: Restart the LSA services to reload and update the library.
- **Issue:** LSA may be inaccessible after a successful firmware update while I/Os are occurring.
Workaround: Restart the LSA services.
- **Issue:** LSA may stop responding when downloading support logs on multiple clients.
Workaround: Restart the LSA services. Collect logs from one client at a time during non-heavy I/O or drive or blackplane operations.

NOTE

Downloading the support log is available only for admin users.

- **Issue:** LSA allows the Guest user to log in when the Guest user is disabled through the **User Accounts**.
Workaround:
 1. Open the command prompt.
 2. At the command prompt, enter the `lusrmgr.msc` command.
 3. Select **Users** and then **Guest**.
 4. Right-click on the **Guest User**, and select the **Properties** option.

5. Select the check box **Account is Disabled** if not already selected.
- **Issue:** The server response of IPv4 and IPv6 address groups are intermixed in the presence of multiple NIC cards.
Workaround: None.
 - **Issue:** When the auto rebuild is enabled, multiclick PD actions are not updated properly.
Workaround: Manually refresh the page.
 - **Issue:** Downgrading from 004.003.000.00 and higher is not recommended because uninstallation of the previous version can be erratic.
Workaround: Uninstall the latest version, and reinstall an earlier version.
Version: 004.003.000.00 and higher.
 - **Issue:** Google Chrome may not position pop-up windows correctly.
Workaround: None.
Version: 61.0.3163.100 and later.
 - **Issue:** When using Mozilla Firefox, do not save the user name and password or click the user name text box to enable saving.
Workaround: None.
 - **Issue:** Updating or erasing the UEFI or BIOS from any utility other than LSA results in LSA displaying old UEFI and BIOS information.
Workaround: Reboot so that LSA will display the correct BIOS details.
Version: IT controllers only.
 - **Issue:** The user cannot disable or modify the security, and cannot delete the virtual drive, or cannot clear the configuration.
Workaround: Clear the TR from DG, and perform the respective operations.
 - **Issue:** No matter the state of the controller or virtual drive, the state is optimal and some operations may fail on TR DG/VD, which is beyond the scope of LSA.
Workaround: Clear the TR from DG, and perform the respective operations.
 - **Issue:** Operations performed during an online controller reset fail.
Workaround: Do not perform any operation in LSA during an online controller reset.
 - **Issue:** Clicking between server nodes in remote and manage discovery pages results in an intermittent disappearance of servers or server icons.
Workaround: After clicking between server nodes, wait a few seconds for the screen to refresh to see all of the server nodes and icons.
Version: Mozilla Firefox and Windows Server 2012.
 - **Issue:** Zoom operations do not function properly when the monitor resolution is high.
Workaround: Do not use zoom operations on a browser until the monitor resolution is low.
 - **Issue:** Performing any action (for example, **Configuration**) from the **Server** summary page and then manually refreshing the page causes the user to be redirected to the initially selected **Action** page.
Workaround: Do not perform a manual refresh.
 - **Issue:** Converting a JBOD PD from JBOD to UG causes applications to display different action menu names. LSA displays the JBOD as **Make unconfigured good**.
 - **Issue:** If the same dedicated hot spare is assigned to multiple drive groups, you may see inconsistency in the **Element Count** and **DHSP Element** selection check boxes on the **Controller** page.
 - **Issue:** Discovery of the server through the **Manual Discovery** option has the following limitations.
 - The Discovery server port should be 2463.
 - The Discovery server protocol should be HTTP.
 - **Issue:** In MegaRAID, when the patrol read is running at the physical drive level, it is a controller-level operation. Each individual physical drive patrol read progress bar does not disappear after completing 100%.

Workaround: Wait for all of the physical drive progress bars to complete. Once all of the physical drive progress bars have reached 100%, they disappear.

- **Issue:** During installation or uninstallation, the publisher can show as unknown in the **User Account Control** message box.
- **Issue:** If you select **Add the Virtual Drive(s)** from existing free space on a drive group or **Delete virtual drive(s)** from an existing drive group, LSA refreshes the complete **Controller** page to update the configuration information. Due to a page refresh, the mouse reference is removed, so the page does not scroll up or down if you scroll the page using the mouse wheel.

Workaround: Click once anywhere on the page so that page scrolling works. Alternatively, you can use the scrollbar.

- **Issue:** LSA does not allow the physical drive to be selected from non-spanned virtual drives or spanned virtual drives.
- **Issue:** The **Modify** or **Repair** options for the existing `setup.exe` file does not work.

Workaround: Uninstall and reinstall the build instead of using the **Modify** or **Repair** options.

LSA Features

This chapter summarizes the LSA feature differences between LSA 7.x and LSA 8.x.

LSA Features Differences

The following table shows LSA feature differences. Features not included in the table have the same functionality between LSA versions.

Table 36: Supported Features Differences

Feature	LSA 7x	LSA 8.x	Behavioral Difference
Configuration			
Advanced Configuration	Yes	Yes	RAID 00 and RAID 10 users will not see the span changing bar for 8.x controllers as user span selection is not supported. LSA 7.x RAID 1 maximum PD support in a DG is 32. LSA 8.2 RAID 1 maximum PD support in a DG is 2.
CacheCade - SSD Caching configuration	Yes	—	—
Foreign Configuration (Import/Clear/Re-Scan)	Yes	Yes	In LSA 8.x, when applicable, you see nonimportable and locked PDs as the first page when selecting a foreign configuration link. In LSA 8.x, when unlocking the drives the unlocked pd list displays.
Clear Configuration	Yes	Yes	LSA 8.x displays the ID of the VD target containing the OS/FS/Unknown boot partition.
Update Firmware Regular and OFU. IR/IT: Bios/EFI-BSD Update Options also Present.	Yes	Yes	In LSA 7.x, based on the <code>supportAutoReset</code> bit, the firmware flash is set to <code>Online</code> by default. BIOS/EFI-BSD update options are present only for LSA 7.x IR/IT controllers. In LSA 8.x both <code>Online</code> or <code>Offline</code> activation are provided.
Controller Operations			
Health	Yes	Yes	All cases of PD, VD, and DG health are either optimal or need attention in 8.x.
Schedule Consistency Check	Yes	Yes	Scheduling can be done only with supported RAID levels that are created in 7.x. Interval frequency, maximum concurrency, and load factory defaults can be changed only in the 8.x controller.
Schedule Patrol Read	Yes	Yes	Interval frequency can be only changed in the LSA 8.x controller. Load factory defaults are only available for LSA 8.x.
Manage SAS Storage Link Speed	Yes	Yes	For LSA 8.x, if the <code>IsMixAllowed</code> bit is available then a single <code>changelinkspeed</code> setting is displayed. When changing the SAS, PCIe link, or Lane speed, the user is asked to reboot the system or reset the controller. <ul style="list-style-type: none"> • LSA 7.x: <code>system reboot</code> • LSA 8.x: <code>controller reset</code> or <code>system reboot</code>

Feature	LSA 7x	LSA 8.x	Behavioral Difference
Manage PCIe Storage Interface	Yes	Yes	When changing the SAS, PCIe link, or Lane speed, the user is asked to reboot the system or reset the controller. <ul style="list-style-type: none"> LSA 7.x: system reboot LSA 8.x: controller reset or system reboot
Enable/Disable Alarm	Yes	—	—
Silence Alarm	Yes	—	—
Download TTY Log	Yes	—	In LSA 8.x the TTY Log is part of Snapdump zip file.
Premium Features	Yes	Yes	The maximum configuration support is displayed in LSA 8.x.
RAID Level Migration	Yes	—	—
Change Behavior and Parameters	Yes	—	LSA 8.x: <ul style="list-style-type: none"> Auto-configure behavior (Primary): Based on the FW supported options. Auto-configure behavior (Secondary): Based on the FW supported options Auto-configure behavior (Execute Once): Based on the FW supported options LSA 7.x: Change Auto-configure behavior and corresponding supported parameters.
Profile Management	Yes	—	—
Enable/Disable SCSI Unmap	Yes	—	—
Set Snapdump Properties	Yes	—	In 7.x, based on FW support bit users can set Snapdump properties. In 8.x, all Snapdump properties are FW specific and cannot be set.
Generate Snapdump	Yes	Yes	In LSA 8.x you can trigger this operation with a FW-defined time interval. This operation cannot trigger continuously.
Make Drives Unconfigured Good (controller level and batch) – Only During Advanced Configuration	—	—	For a single LSA, this feature is not supported. For example, the JBOD to UG Conversion page is not displayed.
Firmware Activation Status	—	Yes	—
Factory Defaults	—	Yes	—
Update Firmware	Yes	Yes	The LSA 8.x Update Firmware option has online and offline activation radio buttons. By default, the online button is selected. The LSA 7.x controller firmware option activation depends on the OFU bit. Online activation is usually selected.
Drive Group Operations			
Modify Drive Group	Yes	—	—
Disable Data Protection (Supported only up to Invader Generation)	Yes	—	—
Add Virtual Drive	Yes	Yes	The minimum VD size is different between 7.x and 8.x.
Hide/Unhide	Yes	—	—

Feature	LSA 7x	LSA 8.x	Behavioral Difference
Spanned Drive Group Operations			
Disable Data Protection	Yes	—	—
Hide/Unhide	Yes	—	—
Virtual Drive Operations			
Modifying Properties	Yes	Yes	BGI enable/disable is removed from the converged LSA. For LSA 8.x, the IO policy is not displayed.
Start/Stop Locating	Yes	Yes	For 8.x, the Locate Indefinite option is available.
Expand	Yes	Yes	Expanding the Online capacity of a VD has two possible scenarios. <ul style="list-style-type: none"> • Online Capacity Expansion (OCE) – If a VD is created with a full PD size, adding PDs is possible. • If VD is partial (the full size is not used), the VD size (capacity) can be expanded. For 7.x, only the second scenario is applicable, the first scenario is not supported. For 8.x, both scenarios are supported.
Delete	Yes	Yes	LSA 8.x displays the ID of the VD Target containing the OS/FS/Unknown boot partition.
Enable/Disable SSD Caching	Yes	—	—
Hide/Unhide	Yes	—	—
Enable Unmap/Write Same Unmap	—	Yes	—
Transport Ready	Yes	—	—
Physical Drive Operations			
Assign or Unassign Global Hot Spare	Yes	Yes	LSA 8.x: When the global hot spare limit is exceeded, LSA continues to show the operation and fail the operation with a corresponding error message.
Assign (or) Unassign Dedicated Hot Spare	Yes	Yes	LSA 7.x: A single PD can be assigned as hot spare to multiple DGs. LSA 8.x: <ul style="list-style-type: none"> • A single PD can be assigned as a hot spare for a single DG. • When the dedicated hot spare limit is exceeded, LSA continues to show the operation and fail the operation with a corresponding error message.
Make Unconfigured Good	Yes	—	—
Make Offline/Online	Yes	Yes	LSA 8.x: When the drive state changes from offline to online, LSA displays the data corruption confirmation message only when the <code>Force Required</code> field is set.
Make Unconfigured	—	Yes	—
Make Good	—	Yes	—
Start/Spin-Up Drives	—	Yes	—
Energy Pack			

Feature	LSA 7x	LSA 8.x	Behavioral Difference
Start Manual Learn Cycle	Yes	—	—
Tape Drive (— Operations Supported)	Yes	—	—

LSA Terminology Differences

The following table shows the terminology changes between LSA versions.

Table 37: LSA Terminology Changes

LSA 7.21 and earlier	LSA 7.22 and 8.x and later
Premium Features	Advanced Software options
Encrypted/Encryption	Secured/Secure
View Event Log	Show events
Sector size	Logical Sector Size
Type	Media
Backplane	Logical Enclosure
DeviceID	PCI Device ID
Vendor ID	PCI Vendor ID
Sub Vendor ID	PCI Subsystem Vendor ID
MegaRAID — Removed from the places related to premium features and Advanced Software options.	
Drive Security Properties	Security Properties
Disk cache	Drive write cache
Pause	Suspend
Abort	Stop
Set Patrol Read Properties	Schedule Patrol Read Properties
Usable Capacity	Coerced Capacity
Reconstruction	Transformation
Enclosure ID	ID
Enclosure Sub Type	Sub Type
Set Patrol Read Mode	Set Mode
Schedule Patrol Read every	Schedule every
Start Patrol Read Now	Start Now
Set Consistency Check Mode	Set Mode
Schedule Consistency Check every	Schedule every
Hotspare	Hot spare
Row Index	Missing Position
Yes, Make Drive Offline	Yes, Make Offline
Yes, Make Drive Online	Yes, Make Online

LSA 7.21 and earlier	LSA 7.22 and 8.x and later
Mark Drive as Missing	Mark Missing
Make JBOD Secure	Secure JBOD
Make Drive Offline	Make Offline
Are you sure you want to clear the Log, Yes, Clear Log Download Log Clear Log log cleared	Are you sure you want to clear the Events, Yes, Clear Events Download Events Clear Events Event Cleared
Negotiated Link Speed	Negotiated Speed
Drive Speed	Capable Speed
Revision Level	Product Revision Level
Power Status	Power State
Write Cache	Current Write Cache
Enclosure — Repetitive uses of the term Enclosure is removed in Enclosure properties panel.	
Full Disk Encryption Capable	SED Capable
Drive Cache	Drive Cache Policy
No of Slots	Number of Slots
No of Fans	Fans Count
No of Temperature Sensors	Temperature Sensors Count
No of Power Supplies	Power Supplies Count
No of Voltage Sensors	Voltage Sensors Count
Pause for password at boot time	Pause for Passphrase
Drive Stand By time	Spin Down Time
Secure using FDE	Secure
Current Personality	Controller Personality
Change Behavior Mode	Change Auto-configure behavior
SES Association Type	SES VPD Association Type
Manage PCIe Storage Interface	Manage PCIe Storage Lane Speed
Max Lane Width	Capable Lane Width
Current Speed	Negotiated Speed
Snap Dump	Snapdump — All instances of Snap Dump changed to Snapdump.
Drive Security	Security - All instances of Drive Security changed to Security.
Emergency for SMARTer	Emergency Spare for SMARTer
Firmware Build Time	Package Build Time
Firmware Package Version	Package Version

Glossary

This glossary defines the terms and acronyms used in this document.

access policy	A virtual drive property that indicates what type of access is allowed for a particular virtual drive. The possible values are <i>Read/Write</i> , <i>Read Only</i> , or <i>Blocked</i> .
APIPA	automatic Private IP addressing. A Windows-based operating system feature that enables a computer to automatically assign itself an IP address when no DHCP server is available to perform that function.
BIOS	basic input/output system. The computer BIOS is stored on a Flash memory chip. The BIOS controls communications between the microprocessor and peripheral devices, such as the keyboard and the video controller, and miscellaneous functions, such as system messages.
cache	Fast memory that holds recently accessed data. Use of cache memory speeds subsequent access to the same data. When data is read from or written to main memory, a copy is also saved in cache memory with the associated main memory address. The cache memory software monitors the addresses of subsequent read operations to see whether the required data is already stored in cache memory. If it is already in cache memory (a cache hit), it is read from cache memory immediately and the main memory read operation is aborted (or not started). If the data is not cached (a cache miss), it is fetched from main memory and saved in cache memory.
caching	The process of using a high speed memory buffer to speed up a computer system's overall read/write performance. The cache can be accessed at a higher speed than a drive subsystem. To improve read performance, the cache usually contains the most recently accessed data, as well as data from adjacent drive sectors. To improve write performance, the cache can temporarily store data in accordance with its write back policies.
capacity	A property that indicates the amount of storage space on a drive or virtual drive.
coerced capacity	A drive property that indicates the capacity to which a drive has been coerced (forced) to make it compatible with other drives that are nominally the same capacity. For example, a 4-GB drive from one manufacturer might be 4196 MB, and a 4-GB from another manufacturer might be 4128 MB. These drives could be coerced to a usable capacity of 4088 MB each for use in a drive group in a storage configuration.
coercion mode	A controller property indicating the capacity to which drives of nominally identical capacity are coerced (forced) to make them usable in a storage configuration.
consistency check	An operation that verifies that all stripes in a virtual drive with a redundant RAID level are consistent and that automatically fixes any errors. For RAID 1 drive groups, this operation verifies correct mirrored data for each stripe.
consistency check rate	The rate at which consistency check operations are run on a computer system.
controller	A chip that controls the transfer of data between the microprocessor and memory or between the microprocessor and a peripheral device such as a drive. RAID controllers perform RAID functions such as striping and mirroring to provide data protection.
current	Measure of the current flowing to (+) or from (–) the energy pack, reported in milliamperes.
current write policy	A virtual drive property that indicates whether the virtual drive currently supports Write Back mode or Write Through mode. <ul style="list-style-type: none">• In Write Back mode, the controller sends a data transfer completion signal to the host when the controller cache has received all of the data in a transaction.• In Write Through mode, the controller sends a data transfer completion signal to the host when the drive subsystem has received all of the data in a transaction.
device ID	A controller or drive property indicating the manufacturer-assigned device ID.
DHCP	dynamic host configuration protocol
drive group	A group of drives attached to a RAID controller on which one or more virtual drives can be created. All virtual drives in the drive group use all of the drives in the drive group.

drive state	<p>A physical drive or a virtual drive property indicating the status of the appropriate drive.</p> <p>Physical Drive State</p> <p>A physical drive can be in any one of the following states:</p> <ul style="list-style-type: none"> • Unconfigured Good – A drive accessible to the RAID controller but not configured as a part of a virtual drive or as a hot spare. • Hot Spare – A drive that is configured as a hot spare. • Online – A drive that can be accessed by the RAID controller and will be part of the virtual drive. • Rebuild – A drive to which data is being written to restore full redundancy for a virtual drive. • Failed – A drive that was originally configured as Online or Hot Spare, but on which the firmware detects an unrecoverable error. • Unconfigured Bad – A drive on which the firmware detects an unrecoverable error; the drive was Unconfigured Good or the drive could not be initialized. • Missing – A drive that was Online, but which has been removed from its location. • Offline – A drive that is part of a virtual drive but which has invalid data as far as the RAID configuration is concerned. • None – A drive with an unsupported flag set. <p>An Unconfigured Good or Offline drive that has completed the prepare for removal operation.</p> <p>Virtual Drive State</p> <p>A virtual drive can be in any one of the following states:</p> <ul style="list-style-type: none"> • Optimal – A virtual drive whose members are all online. • Partially Degraded – A virtual drive with a redundant RAID level that is capable of sustaining more than one member drive failure. <p>This state also applies to the virtual drive's member drives. Currently, a RAID 6 or RAID 60 virtual drive is the only virtual drive that can be partially degraded.</p> <ul style="list-style-type: none"> • Degraded – A virtual drive with a redundant RAID level with one or more member failures and can no longer sustain a subsequent drive failure. • Offline – A virtual drive with one or more member failures that make the data inaccessible.
drive type	A drive property indicating the characteristics of the drive.
energy pack	Refers to a battery backup unit or a CacheVault.
fast initialization	The firmware quickly writes zeros to the first and last 8-MB regions of the new virtual drive, and then completes the initialization in the background or with next scheduled Consistency Check. This allows you to start writing data to the virtual drive immediately.
fault tolerance	The capability of the drive subsystem to undergo a single drive failure per drive group without compromising data integrity and processing capability. SAS RAID controllers provide fault tolerance through redundant drive groups in RAID levels 1, 5, 6, 10, 50, and 60. They also support hot spare drives and the auto-rebuild feature.
firmware	Software stored in read-only memory (ROM) or programmable ROM (PROM). Firmware is often responsible for the behavior of a system when it is first turned on. A typical example would be a monitor program in a system that loads the full operating system from drive or from a network and then passes control to the operating system.
foreign configuration	A RAID configuration that already exists on a replacement set of drives that you install in a computer system. MegaRAID Storage Manager software lets you import the existing configuration to the RAID controller, or you can clear the configuration so you can create a new one.
formatting	The process of writing a specific value to all data fields on a drive, to map out unreadable or bad sectors. Because most drives are formatted when manufactured, formatting is usually performed only if a drive generates many media errors.
GUI	graphical user interface.
GT/s	giga transfers per second.
HDD	hard disk drive.

hot spare	<p>A standby drive that can automatically replace a failed drive in a virtual drive and prevent data from being lost. A hot spare can be dedicated to a single redundant drive group or it can be part of the global hot spare pool for all drive groups controlled by the controller.</p> <p>When a drive fails, MegaRAID Storage Manager software automatically uses a hot spare to replace it and then rebuilds the data from the failed drive to the hot spare. Hot spares can be used in RAID 1, 5, 6, 10, 50, and 60 storage configurations.</p>
HPC	high performance computing.
initialization	The process of writing zeros to the data fields of a virtual drive and, in fault-tolerant RAID levels, generating the corresponding parity to put the virtual drive in a Ready state. Initialization erases all previous data on the drives. Drive groups will work without initializing, but they can fail a consistency check because the parity fields have not been generated.
IO policy	A virtual drive property indicating whether Cached I/O or Direct I/O is being used. In Cached I/O mode, all read operations are buffered in cache memory. In Direct I/O mode, read operations are not buffered in cache memory. Data is transferred to cache and the host concurrently. If the same data block is read again, it comes from cache memory. (The IO Policy applies to read operations on a specific virtual drive. It does not affect the read-ahead cache.)
learning cycle	An energy pack calibration operation performed by a RAID controller periodically to determine the condition of the energy pack. You can start energy pack learn cycles manually or automatically
load-balancing	A method of spreading work between two or more computers, network links, CPUs, drives, or other resources. Load balancing maximizes resource use, throughput, or response time.
manufacturing date	Date on which the energy pack assembly was manufactured.
manufacturing name	Device code that indicates the manufacturer of the components used to make the energy pack assembly.
migration	The process of moving virtual drives and hot spare drives from one controller to another by disconnecting the drives from one controller and attaching them to another one. The firmware on the new controller will detect and retain the virtual drive information on the drives.
mirroring	The process of providing complete data redundancy with two drives by maintaining an exact copy of one drive's data on the second drive. If one drive fails, the contents of the other drive can be used to maintain the integrity of the system and to rebuild the failed drive.
multipathing	The firmware provides support for detecting and using multiple paths from the RAID controllers to the SAS devices that are in enclosures. Devices connected to enclosures have multiple paths to them. With redundant paths to the same port of a device, if one path fails, another path can be used to communicate between the controller and the device. Using multiple paths with load balancing, instead of a single path, can increase reliability through redundancy.
NIC	network interface card.
NAT	network address translator.
NVMe	nonvolatile memory. NVMe is a logical device interface specification for accessing nonvolatile storage media attached using the PCI Express (PCIe) bus.
offline	A drive is offline when it is part of a virtual drive but its data is not accessible to the virtual drive.
patrol read	A process that checks the drives in a storage configuration for drive errors that could lead to drive failure and lost data. The Patrol Read operation can find and sometimes fix any potential problem with drives before host access. This enhances overall system performance because error recovery during a normal I/O operation might not be necessary.
patrol read rate	The user-defined rate at which patrol read operations are run on a computer system.
PCI	Peripheral Component Interface.
PCIe	PCI Express.

RAID	<p>redundant array of independent disks.</p> <p>A group of multiple, independent drives that provide high performance by increasing the number of drives used for saving and accessing data.</p> <p>A RAID drive group improves input/output (I/O) performance and data availability. The group of drives appears to the host system as a single storage unit or as multiple virtual drives. Data throughput improves because several drives can be accessed simultaneously. RAID configurations also improve data storage availability and fault tolerance. Redundant RAID levels (RAID levels 1, 5, 6, 10, 50, and 60) provide data protection.</p>
RAID 0	Uses data striping on two or more drives to provide high data throughput, especially for large files in an environment that requires no data redundancy.
RAID 1	Uses data mirroring on pairs of drives so that data written to one drive is simultaneously written to the other drive. RAID 1 works well for small databases or other small applications that require complete data redundancy.
RAID 5	Uses data striping and parity data across three or more drives (distributed parity) to provide high data throughput and data redundancy, especially for applications that require random access.
RAID 6	Uses data striping and parity data across three or more drives (distributed parity) to provide high data throughput and data redundancy, especially for applications that require random access. RAID 6 can survive the failure of two drives.
RAID 10	A combination of RAID 0 and RAID 1 that uses data striping across two mirrored drive groups. It provides high data throughput and complete data redundancy.
RAID 50	A combination of RAID 0 and RAID 5 that uses data striping across two drive groups with parity data. It provides high data throughput and complete data redundancy.
RAID 60	A combination of RAID 0 and RAID 6 that uses data striping across two drive groups with parity data. It provides high data throughput and complete data redundancy. RAID 60 can survive the failure of two drives in each RAID set in the spanned drive group.
RAID level	<p>A virtual drive property indicating the RAID level of the virtual drive.</p> <p>Broadcom SAS RAID controllers support RAID levels 0, 1, 5, 6, 10, 50, and 60.</p>
RAID Migration	A feature in RAID subsystems that allows changing a RAID level to another level without powering down the system.
raw capacity	A drive property that indicates the actual full capacity of the drive before any coercion mode is applied to reduce the capacity.
read policy	A controller attribute indicating the current Read Policy mode. In Always Read Ahead mode, the controller reads sequentially ahead of the requested data and stores the additional data in cache memory, anticipating that the data will be needed soon. This speeds up read operations for sequential data, but you will see little improvement when accessing random data. In No Read Ahead mode (known as Normal mode in WebBIOS), read ahead capability is disabled.
rebuild	The regeneration of all data to a replacement drive in a redundant virtual drive after a drive failure. A drive rebuild normally occurs without interrupting normal operations on the affected virtual drive, though some degradation of performance of the drive subsystem can occur.
rebuild rate	The percentage of central processing unit (CPU) resources devoted to rebuilding data onto a new drive after a drive in a storage configuration has failed.
reclaim virtual drive	A method of undoing the configuration of a new virtual drive. If you highlight the virtual drive in the Configuration wizard and click Reclaim , the individual drives are removed from the virtual drive configuration.
reconstruction rate	The user-defined rate at which a drive group modification operation is carried out.
redundancy	A property of a storage configuration that prevents data from being lost when one drive fails in the configuration.
redundant configuration	<p>A virtual drive that has redundant data on drives in the drive group that can be used to rebuild a failed drive. The redundant data can be parity data striped across multiple drives in a drive group, or it can be a complete mirrored copy of the data stored on a second drive.</p> <p>A redundant configuration protects the data in case a drive fails in the configuration.</p>

replace	<p>The procedure used to replace data from a source drive of a virtual drive to a destination drive that is not a part of the virtual drive. The replace operation is often used to create or restore a specific physical configuration for a drive group (for example, a specific arrangement of drive group members on the device I/O buses). The replace operation can be run automatically or manually.</p> <p>Typically, a drive fails or is expected to fail, and the data is rebuilt on a hot spare. The failed drive is replaced with a new drive. Then the data is copied from the hot spare to the new drive, and the hot spare reverts from a rebuild drive to its original hot spare status. The replace operation runs as a background activity, and the virtual drive is still available online to the host.</p>
SAS	Serial-Attached SCSI. SAS is a serial, point-to-point, enterprise-level device interface that leverages the SCSI protocol set. The SAS interface provides improved performance, simplified cabling, smaller connectors, lower pin count, and lower power requirements when compared to parallel SCSI.
SASL	simple authentication and security layer.
SATA	Acronym for Serial Advanced Technology Attachment. A physical storage interface standard. SATA is a serial link that provides point-to-point connections between devices. The thinner serial cables allow for better airflow within the system and permit smaller chassis designs.
SCSI	Small Computer System Interface.
SCSI device type	A drive property indicating the type of the device, such as drive.
serial no.	A controller property indicating the manufacturer-assigned serial number.
SSD	solid state drive.
stripe size	A virtual drive property indicating the length of the interleaved data segments that the RAID controller writes across multiple drives, not including parity drives. For example, consider a stripe that contains 64 KB of drive space and has 16 KB of data residing on each drive in the stripe. In this case, the stripe size is 64 KB, and the strip size is 16 KB. The user can select the stripe size.
striping	<p>A technique used to write data across all drives in a virtual drive.</p> <p>Each stripe consists of consecutive virtual drive data addresses that are mapped in fixed-size units to each drive in the virtual drive using a sequential pattern. For example, if the virtual drive includes five drives, the stripe writes data to drives one through five without repeating any of the drives. The amount of space consumed by a stripe is the same on each drive. Striping by itself does not provide data redundancy. Striping in combination with parity does provide data redundancy.</p>
strip size	The portion of a stripe that resides on a single drive in the drive group.
subvendor ID	A controller property that lists additional vendor ID information about the controller.
temperature	Temperature of the energy pack, measured in Celsius.
URI	uniform resource identifier.
vendor ID	A controller property indicating the vendor-assigned ID number of the controller.
vendor info	A drive property listing the name of the vendor of the drive.
VIPA	virtual IP address. An IP address assigned to multiple domain names or servers that share an IP address based on a single network interface card.
virtual drive	A storage unit created by a RAID controller from one or more drives. Although a virtual drive can be created from several drives, it is seen by the operating system as a single drive. Depending on the RAID level used, the virtual drive can retain redundant data in case of a drive failure.
virtual drive state	A virtual drive property indicating the condition of the virtual drive. Examples include <i>Optimal</i> and <i>Degraded</i> .
write-back	<p>In Write-Back Caching mode, the controller sends a data transfer completion signal to the host when the controller cache has received all of the data in a drive write transaction. Data is written to the drive subsystem in accordance with policies set up by the controller.</p> <p>These policies include the amount of dirty/clean cache lines, the number of cache lines available, and elapsed time from the last cache flush.</p>
write policy	See <i>Default Write Policy</i> .
write-through	In Write-Through Caching mode, the controller sends a data transfer completion signal to the host when the drive subsystem has received all of the data and has completed the write transaction to the drive.

Revision History

Version 2.10, August 28, 2023

The following changes were made:

- Updated [Support Matrix](#).
- Updated [LSI Storage Authority Features](#).
- Updated [Creating a New Storage Configuration Using the Advanced Configuration Option](#).
- Updated [Clearing the Configuration](#).
- Updated [UNMAP Capability Feature](#).
- Updated [Background Operations Support](#).
- Added [Device Reporting Order](#).
- Updated [Starting a Patrol Read Operation](#).
- Updated [Stopping a Patrol Read Operation](#).
- Updated [Enabling Security](#).
- Updated [Changing Security Settings](#).
- Updated [Disabling Security](#).
- Updated [Viewing Physical Drive Properties](#).
- Updated [Sanitizing a Drive](#).
- Updated [Supported Operating Systems](#).
- Updated [Known Issues and Workarounds](#).
- Added [LSA Features](#).
- Added [LSA Features Differences](#).
- Added [LSA Terminology Differences](#).

Version 2.9, June 9, 2023

The following changes were made:

- Updated [Support Matrix](#).
- Added [Configuring LSA on LWA and LWM ESXi](#).
- Updated [Viewing Physical Drive Properties](#).
- Updated [Creating a New Storage Configuration Using the Advanced Configuration Option](#).
- Updated [Adding Hot Spares During Configuration Creation](#).
- Updated [Adding Virtual Drives](#).

Version 2.8, April 10, 2023

The following changes were made:

- Updated [LSI Storage Authority Overview](#).
- Updated [LSI Storage Authority Features](#).
- Updated [Support Matrix](#).
- Updated [Browser Cache](#).
- Updated [StandAlone Installer](#).
- Updated [Uninstalling in Interactive Mode](#).
- Updated [Installing LWA on VMware ESXi](#).
- Added [Installing LWA on VMware ESXi 7.x](#).
- Added [Installing LWA on VMware ESXi 8.x](#).
- Added [Managing LSA and Web Services on VMware ESXi 8.x](#).
- Updated [Configuring the Firewall on Gateway/StandAlone Installer \(Windows\)](#).
- Updated [Collecting Logs with InDirectAgent SMIS-Based Management](#).
- Updated [Collecting Logs on Windows and Linux Operating Systems](#).
- Updated [Behavior of Event Monitoring](#).
- Updated [Creating a New Storage Configuration Using the Advanced Configuration Option](#).
- Updated [Managing SAS Storage Link Speed](#).
- Added [Drive Spin Up](#).
- Updated [Enabling the Schedule Panel Feature](#).
- Updated [Disabling the Schedule Panel Feature](#).
- Updated [Modifying the Time Limit of the Schedule Panel](#).
- Updated [Hiding and Unhiding a Virtual Drive or a Drive Group](#) and subsections.
- Updated [Known Issues and Workarounds](#).
- Minor rewrites for clarity and consistency.
- Updated images.

Version 2.7, January 13, 2023

The following changes were made:

- Updated [Support Matrix](#).
- Updated [Scheduling a Patrol Read](#).
- Minor rewrites for clarity and consistency.

Version 2.6, November 15, 2022

The following changes were made:

- Updated [Configuring HTTPS](#).
- Updated [Resetting Encryption Keys](#).
- Updated [Uninstalling in Noninteractive Mode](#).
- Updated [Collecting Logs on Windows and Linux Operating Systems](#).
- Updated [Adding Translated Names in Windows](#).
- Updated [Scheduling a Consistency Check](#).
- Updated [Scheduling a Patrol Read](#).
- Updated [Updating the Controller Firmware](#).
- Updated [Viewing Drive Group Properties](#).
- Updated [Viewing Virtual Drive Properties](#).
- Added [Viewing Volatile Properties](#).
- Updated [Viewing Energy Pack Properties](#).
- Added [Viewing Partner Enclosure Properties](#).
- Updated [Known Issues and Workarounds](#).

Version 2.5, August 24, 2022

The following changes were made:

- Updated [Support Matrix](#).
- Updated [Managing LSA and Web Services on VMware ESXi 7.x](#).
- Updated [Creating a New Storage Configuration Using the Advanced Configuration Option](#).
- Updated [Updating the Controller Firmware](#).
- Updated [Firmware Activation Status](#).
- Updated [Adding a Virtual Drive to a Drive Group](#).
- Updated [Viewing Virtual Drive Properties](#).
- Updated [Viewing Physical Drive Properties](#).
- Updated [Supported Operating Systems](#).
- Updated [Summary of RAID Levels](#).
- Updated [RAID 0 Drive Groups](#).

Version 2.4, June 15, 2022

The following changes were made:

- Updated [Support Matrix](#).
- Updated [Alert Settings](#).
- Updated [Setting Up the Email Server](#).
- Added [Using the CacheCade Pro 2.0 Feature](#) and subsections.
- Added [Viewing Tape Drives](#).
- Added [Installing the Light Weight Monitor on the Windows Operating System through the LSA Stand-Alone Installation](#).
- Added [Installing Light Weight Monitor on the Oracle Solaris x86 Operating System](#).
- Added [Uninstalling the Light Weight Monitor on the Oracle Solaris x86 Operating System](#).
- Added [Setting Up the Custom Facility Level in the System Log File for the Solaris x86 Operating System](#).
- Updated [Known Issues and Workarounds](#).

Version 2.3, May 10, 2022

The following changes were made:

- Updated [Support Matrix](#).
- Added [Managing LSA on VMware ESXi Operating Systems](#) and subsections.
- Updated [Limitations of Installation and Configuration](#).
- Added [UNMAP Capability Feature](#) and subsections.
- Added [Profile Management](#) and subsections.
- Updated [Managing PCIe Storage Lane Speed](#).
- Updated [Managing Power-Save Settings](#).
- Added [Downloading the TTY Log](#).
- Updated [Updating the Controller Firmware](#).
- Added [Firmware Activation Status](#).
- Added [Managing Factory Defaults](#).
- Added [RAID Level Migration](#) and subsections.
- Added [Expanding the Online Capacity of a Virtual Drive](#).
- Updated [Assigning Dedicated Hot Spares](#).
- Added [Hiding and Unhiding a Virtual Drive or a Drive Group](#) and subsections.
- Added [Viewing Protected Drive Groups](#).
- Added [Sanitizing a Drive](#).
- Updated [Viewing Energy Pack Properties](#).
- Added [Setting Learn Cycle Properties](#).
- Added [Starting a Learn Cycle Manually](#).
- Updated [Known Issues and Workarounds](#).
- Minor rewrites for clarity and consistency.

Version 2.2, November 11, 2021

The following changes were made:

- Updated [Support Matrix](#).
- Updated [LSI Storage Authority Features](#).
- Updated [Types of Installation](#).
- Removed [Managing LSA on the VMware ESXi Operation System](#) chapter and subsections.
- Updated [Server Dashboard](#).
- Updated [Changing Behavior Modes](#) section.
- Updated [Controller Dashboard](#).
- Removed [UNMAP Capability Feature](#) section and subsections.
- Updated [Personality Management](#).
- Removed [Changing Profiles](#) section.
- Updated [Background Operations Support](#).
- Updated [Managing Controllers](#).
- Removed [Downloading the TTY Log](#) section.

- Updated [Advanced Software](#).
- Removed Using the CacheCade Pro 2.0 Feature section and subsections.
- Updated [Managing Drive Groups](#).
- Removed RAID Level Migration section and subsections.
- Updated [Managing Virtual Drives](#).
- Removed Hiding and Unhiding a Virtual Drive or a Drive Group section and subsections.
- Updated [Managing Physical Drives](#).
- Removed Sanitizing a Drive section.
- Updated [Managing Hardware Components](#).
- Removed Setting Learn Cycle Properties section.
- Removed Starting a Learn Cycle Manually section.
- Removed Viewing Tape Drives section.
- Updated [Show Events](#).
- Updated [Supported Operating Systems](#) for Light Weight Monitor System.
- Removed Installing the Light Weight Monitor on the Windows Operating System through the LSA Stand-Alone Installation section.
- Removed Installing Light Weight Monitor on the Oracle Solaris x86 Operating System section.
- Removed Uninstalling the Light Weight Monitor on the Oracle Solaris x86 Operating System section.
- Updated [Configuring the Light Weight Monitor System](#).
- Removed Setting Up the Custom Facility Level in the System Log File for the Solaris x86 Operating System section.
- Updated [Introduction to RAID](#).
- Updated [Events and Messages](#).
- Removed Event Messages section.
- Updated the screenshots throughout the guide.
- Minor rewrites for clarity and consistency.

Version 2.1, September 22, 2021

The following changes were made:

- Updated [Changing Profiles](#).
- Updated [Enabling the Schedule Panel Feature](#).
- Updated [Setting Up the Email Server](#).
- Updated [Adding Email Addresses of Recipients of Alert Notifications](#).
- Minor rewrites for clarity and consistency.

Version 2.0, June 17, 2021

The following changes were made:

- Updated [Support Matrix](#).
- Updated [Limitations of Installation and Configuration](#).
- Updated [Changing Behavior Modes](#).
- Updated [Viewing Controller Properties](#).
- Updated [Updating the Controller Firmware](#).
- Updated [Changing Security Settings](#).
- Changed **Copyback** operation name to **Replace**.
- Updated [Event Messages](#).
- Updated [Known Issues and Workarounds](#).
- Minor rewrites for clarity and consistency.

Version 1.16, March 5, 2021

The following changes were made:

- Updated [Managing LSA on VMware ESXi Operating Systems](#).
- Added [Replacing a Missing Drive](#).
- Minor rewrites for clarity and consistency.

Version 1.15, October 30, 2020

The following changes were made:

- Updated [Creating a New Storage Configuration Using the Advanced Configuration Option](#).
- Updated [Server Dashboard](#).
- Updated [Managing LSA on VMware ESXi Operating Systems](#).
- Updated [Known Issues and Workarounds](#).
- Minor rewrites for clarity and consistency.

Version 1.14, July 24, 2020

The following changes were made:

- Updated [Support Matrix](#).
- Updated [Configuring HTTPS](#).
- Updated [Resetting Encryption Keys](#).
- Updated [Installing in the Interactive Mode](#).
- Updated [Upgrading and Downgrading the Firmware on IT Controllers \(VMware\)](#).
- Updated [Updating the Controller Firmware](#).
- Updated [Changing Security Settings](#)
- Added [Known Issues and Workarounds](#).
- Minor rewrites for clarity and consistency.

Version 1.13, December 23, 2019

The following changes were made:

- Updated [Support Matrix](#).
- Updated [Scheduling a Patrol Read](#).
- Updated [Preinstallation Requirements](#)
- Minor rewrites for clarity and consistency.

Version 1.12, September 17, 2019

The following changes were made:

- Added Snapdump Features.
- Added UNMAP Capability Feature.
- Replaced the screen captures that follow.
 - Alert Delivery Window
 - Server Dashboard
 - View Server Profile Window
 - Controller Dashboard
 - Background Processes in Progress Window

- Virtual Drive Properties Window
- Energy Pack Properties Window
- Enclosure Properties
- Minor rewrites for clarity and consistency.

Version 1.11, May 30, 2018

The following changes were made:

- Removed Private IP Range Restrictions.
- Updated Managing Servers from the Remote Server Discovery Page.
- Added Manually Discovering Server.
- Added Marking a Drive as a Missing Drive.

Version 1.10, February 16, 2018

The following changes were made:

- Added a procedure of *Optimizing Event Notifications* to Section 8, Managing LSA on VMware ESXi Operating Systems.
- Updated Creating a New Storage Configuration Using the Advanced Configuration Option.
- Updated Adding Physical Drives.
- Updated Adding Hot Spares to the Existing Drive Group.
- Updated Viewing Controller Properties.
- Updated Scheduling a Consistency Check.
- Added Section 18.9, Behavior of Virtual Drive Operations on VMware.
- Updated Section 19.9, Assigning Dedicated Hot Spares.

Version 1.9, November 30, 2017

The following changes were made:

- Updated support for Tape Drive in Section 19.2, Tape Drives.
- Updated images.

Version 1.8, September 11, 2017

The following changes were made:

- Merged the *Light Weight Monitor (LWM)* User Guide into this document from Chapter 16 through Chapter 18.
- Updated Section 2.1, Support Matrix.
- Updated Section 6, Installing the LSI Storage Authority Software on the Microsoft Windows Operating System.
- Added Section 9.4, Hiding an Empty Backplane.
- Updated Updating the Controller Firmware.

Version 1.7, June 21, 2017

The following changes were made:

- Added Section 8.1.1, Increasing the Memory Limit of Host Hardware RAID Controller.
- Updated Section 8.3, Configuring the Firewall on Various LSA Installers
- Updated Section 8.4, Collecting LSA Logs on Windows and Linux Operating Systems.
- Updated Section 8.5, Collecting LSA Logs on VMware Operating Systems.
- Updated Section 8.6, Logout and Reboot Requirements on VMware.

- Updated Section 8.7, Behavior of Event History.
- Updated Section 8.8, Behavior of Event Monitoring on Non-ESXi versus ESXi Server.
- Updated Section 10.2, Displaying or Blocking a Private IP Address.

Version 1.6, March 24, 2017

The following changes are made:

- Added NVMe support.
- Updated Section 6, Installing the LSI Storage Authority Software on the Microsoft Windows Operating System.
- Added Managing PCIe Storage Lane Speed.
- Updated Glossary.

Version 1.5, November 18, 2016

The following change was made:

- Updated Section 8, Managing LSA on VMware ESXi Operating Systems.

Version 1.4, October 6, 2016

The following changes are made:

- Updated LSI Storage Authority Overview.
- Updated Section 2.1, Support Matrix.
- Updated LSI Storage Authority Features.
- Updated the descriptions in Server Dashboard.
- Added Personality Management.
- Updated Basic and Advanced Controller Properties.
- Updated Enabling Drive Security.
- Updated Changing Drive Security Settings.
- Updated Viewing Physical Drive Properties.
- Updated Viewing Enclosure Properties.
- Added HTTP Status Codes and Description and HTTP Status Codes and Description.

Version 1.3, November 2015

Added the following sections:

- LSI Storage Authority Feature Comparison Matrix
- Accessing LSA Over Network Address Translation (NAT)
- Installing the LSI Storage Authority Software on the Linux Operating System
- Viewing Controller Properties
- Viewing Drive Group Properties
- Viewing Virtual Drive Properties
- Viewing Physical Drive Properties
- Viewing Energy Pack Properties
- Monitoring Enclosures
- Viewing Enclosure Properties
- Customizing the Theme of the LSI Storage Authority Software

Version 1.2, July 2015

Added the following sections:

- Using LDAP Authentication
- Managing Servers from the Server Discovery Page
- Adding Managed Servers
- Removing Managed Hosts
- Managing Power Save Settings
- Enabling and Disabling SSD Guard
- Discarding Pinned Cache
- Creating Simple Configuration
- Using the MegaRAID CacheCade Pro 2.0 Feature
- Creating a CacheCade Virtual Drive
- Modifying CacheCade Virtual Drive Properties
- Enabling SSD Caching on a Virtual Drive
- Disabling SSD Caching on a Virtual Drive
- Enabling or Disabling SSD Caching on Multiple Virtual Drives
- Clearing Configuration on CacheCade Virtual Drives
- Removing Blocked Access
- Deleting a Virtual Drive with SSD Caching Enabled
- Fast Path Advanced Software
- MegaRAID SafeStore Encryption Services
- Enabling Drive Security
- Changing Security Settings
- Import or Clear a Foreign Configuration

Version 1.1, April 2015

Added the following chapters:

- Background Operations Support
- Managing Controllers
- MegaRAID Advanced Software Options
- MegaRAID Advanced Software
- Managing Drive Groups
- Managing Virtual Drives
- Managing Physical Drives
- Monitoring Energy Packs

Version 1.0, November 2014

Initial document release.

Documentation Legal Notice

Copyright © 2014-2023 Broadcom. All Rights Reserved. The term “Broadcom” refers to Broadcom Inc. and/or its subsidiaries. For more information, go to www.broadcom.com. All trademarks, trade names, service marks, and logos referenced herein belong to their respective companies.

Broadcom reserves the right to make changes without further notice to any products or data herein to improve reliability, function, or design. Information furnished by Broadcom is believed to be accurate and reliable. However, Broadcom does not assume any liability arising out of the application or use of this information, nor the application or use of any product or circuit described herein, neither does it convey any license under its patent rights nor the rights of others.

